



MONARCH

WOMEN'S OUTDOOR BASKETBALL FOOTWEAR AND APPAREL

**EMILY GUERRA
UO THESIS 2022**



EMILY GUERRA

MY PASSION AS A SPORTS PRODUCT INNOVATOR IS TO DESIGN SOLUTIONS THAT MAXIMIZE ATHLETE PERFORMANCE AND HEALTH WHILE CHALLENGING THE STATUS QUO FOR THE FUTURE OF FOOTWEAR AND APPAREL.

Having experience in sport and rehabilitation has allowed me to witness first-hand the inequalities in men's and women's sports all the way up to the college level not only in opportunity but product as well. Being a female athlete has taught me a lot about teamwork and how to push oneself to challenge limitations.



TABLE OF CONTENTS

RESEARCH	1	WEAR TEST	30
ENVIRONMENT	2	TECH PACKS	32
ATHLETE	4	APPAREL	32
BASELINE PRODUCTS	9	FOOTWEAR	36
BASELINE TESTING	11	FINAL PHOTOGRAPHY	41
PROBLEM STATEMENT	14	PACKAGING	49
POINTS OF FOCUS	15	FINAL RENDER	50
DESIGN PROCESS	17	COLORWAYS	51
SKETCHES	18	VALIDATION RECAP	52
DURABILITY PROCESS/TESTING	21	POINTS OF FOCUS RECAP	53
LAST DEVELOPMENT	24		
PROTOTYPING	25		
TESTING	26		



1893

Women have been playing basketball outdoors for over 100 years.

415,576

The number of high school and college level female basketball athletes during the 2018-19 season according to the NCAA.

500

Approx. number of outdoor courts across NYC's 5 boroughs.

WHY ARE THERE FEW

OUTDOOR BASKETBALL

WOMEN'S

FOOTWEAR AND APPAREL OPTIONS







WEATHER VARIATIONS

HEAT AND RAIN BECOME FACTORS PLAYERS
NEED TO WATCH OUT FOR



VARYING SURFACES

COURTS MAY VARY BETWEEN SLICK AND ROUGH
SURFACE TRACTION



UNEVEN SURFACES

SURFACE IMPERFECTIONS CAN DIFFER BETWEEN
BASE LINES



An aerial, top-down view of an outdoor basketball court. The court is marked with white lines on a dark surface, showing the key, three-point arc, and center circle. Several basketball hoop structures are visible around the perimeter. Numerous players are scattered across the court, some appearing to be in motion. The overall scene is captured in a dark, monochromatic style with high contrast.

CURRENT FOOTWEAR AND APPAREL OPTIONS WORN BY FEMALE ATHLETES ARE NOT DESIGNED FOR THE OUTDOOR ENVIRONMENT AND DO NOT ADEQUATELY ADDRESS THESE FACTORS

ATHLETE

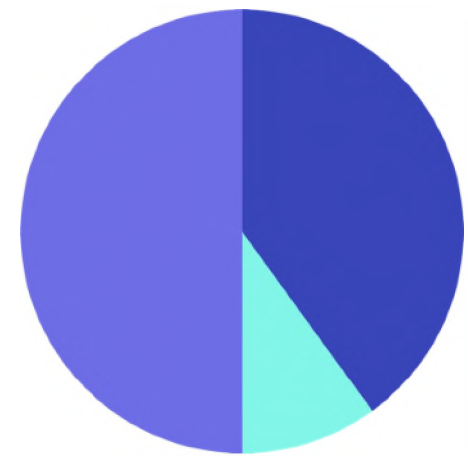

TYPE OF SHOE

- HIGH TOP
- MID TOP
- LOW TOP



WHAT ADDITIONAL EQUIPMENT DO YOU WEAR?

- KNEE PADS/SLEEVE
- SHOOTING SLEEVE
- ANKLE BRACES

ARE DIFFERENT SHOES NECESSARY FOR OUTDOOR BASKETBALL?

"Never wear your indoor shoes outdoors because you will wreck the indoor floor and your shoes."

"Yes because the bottoms would get worn out much quicker on a concrete or pavement surface than indoors, also for indoors they need to stick to the ground well and not be slippery."

"Yes, for the different surfaces of the ground."

"Not really. I wear running sneakers if I'm outdoors so I don't ruin my pair of basketball sneakers."

"Outdoor shoes need to be more durable and more cushioned."

“ THE COURT, ENERGY, GAME ...EVERYTHING JUST FEELS DIFFERENT ”



USER INSIGHTS

“ THE COURT, ENERGY, GAME ... EVERYTHING JUST FEELS DIFFERENT ”

- 27 PARTICIPANTS
- 18-24 AVG. AGE
- 9 AVG. W. SHOE SIZE
- 5'7" AVG. HEIGHT

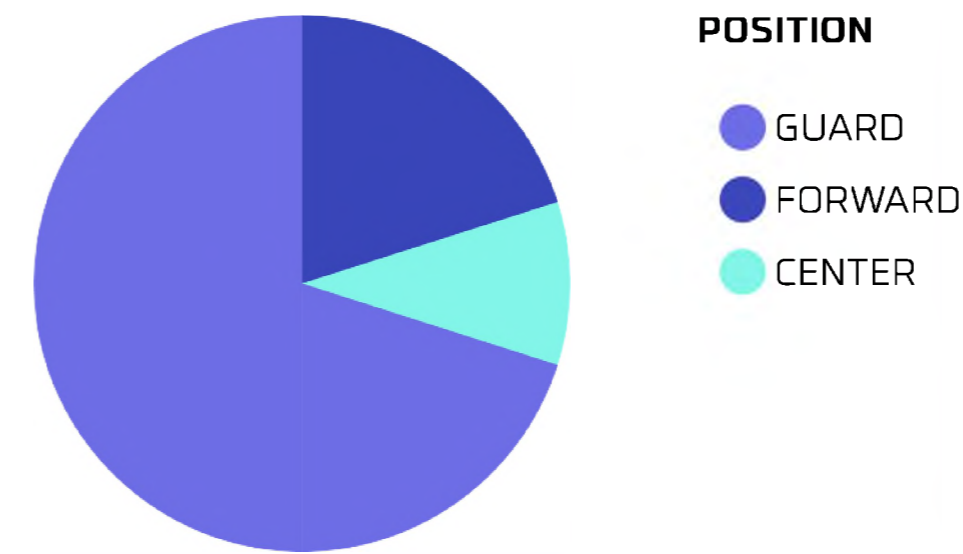
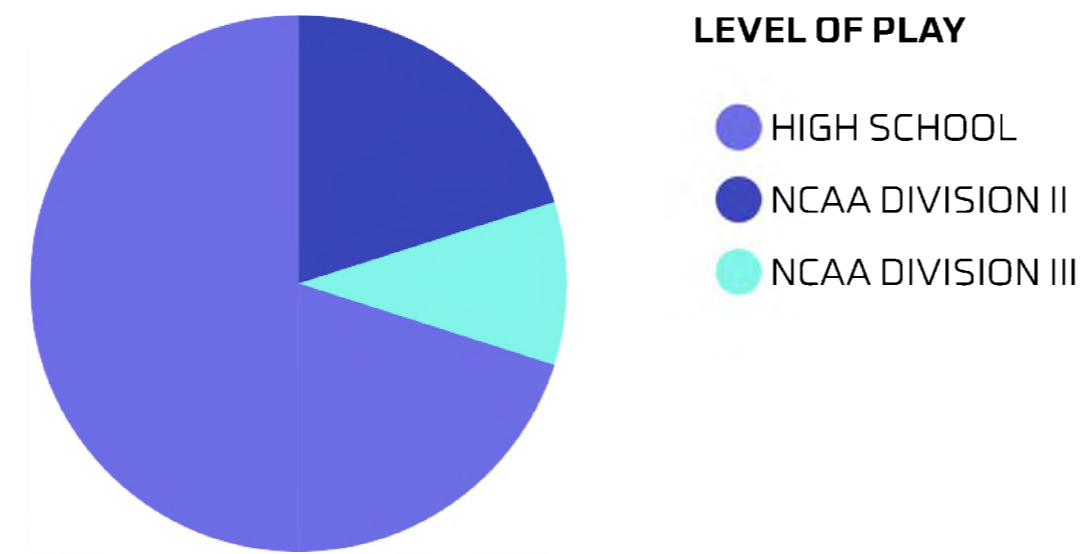

80%

OF ATHLETES SAID THEY EXPERIENCED A LOWER/UPPER LIMB INJURY.

FASTER PACED GAME WITH MORE OFFENSIVE TOUCHES BUT YOU STILL PLAY CONSERVATIVELY TO NOT SLIP OR HIT THE GROUND TOO HARD.

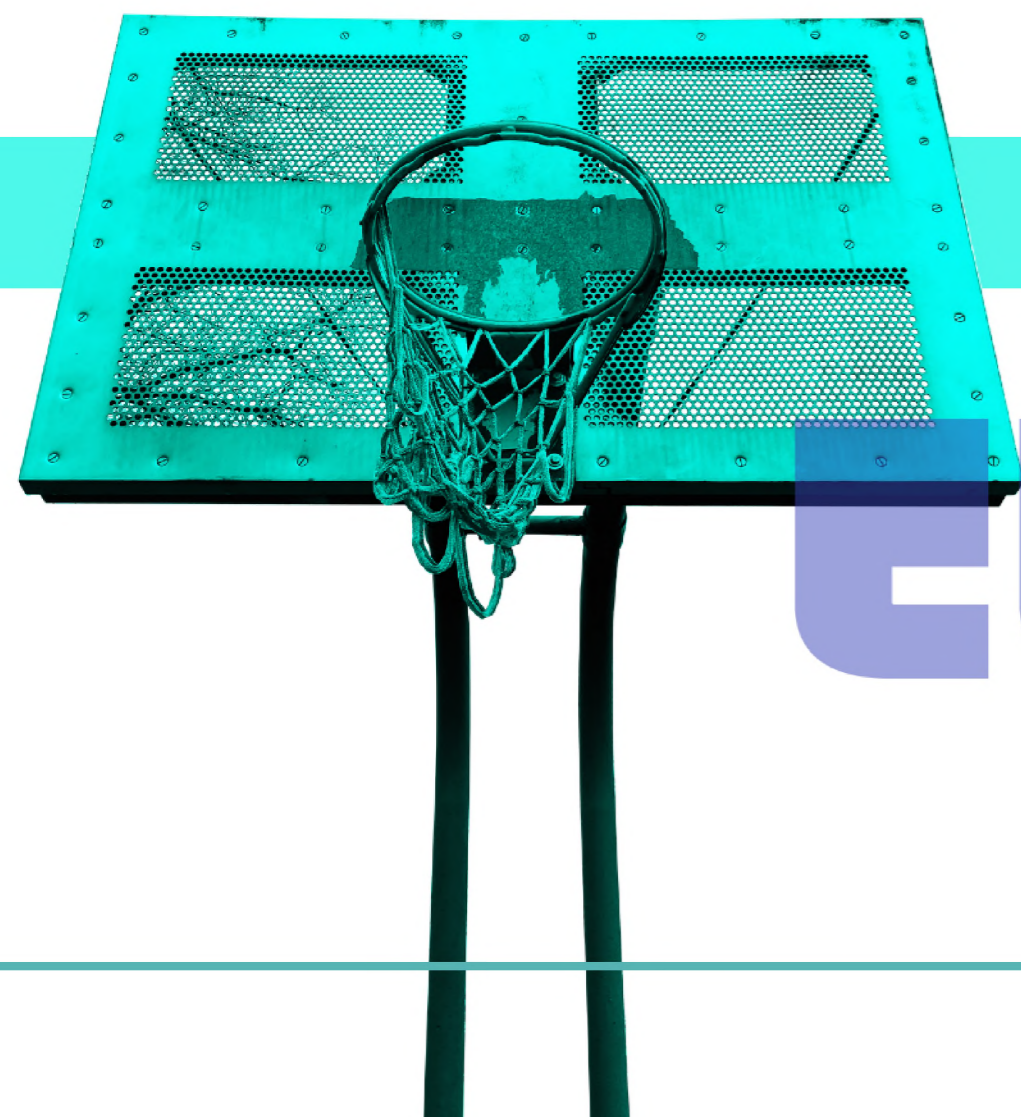

FOOTWEAR USER INSIGHTS

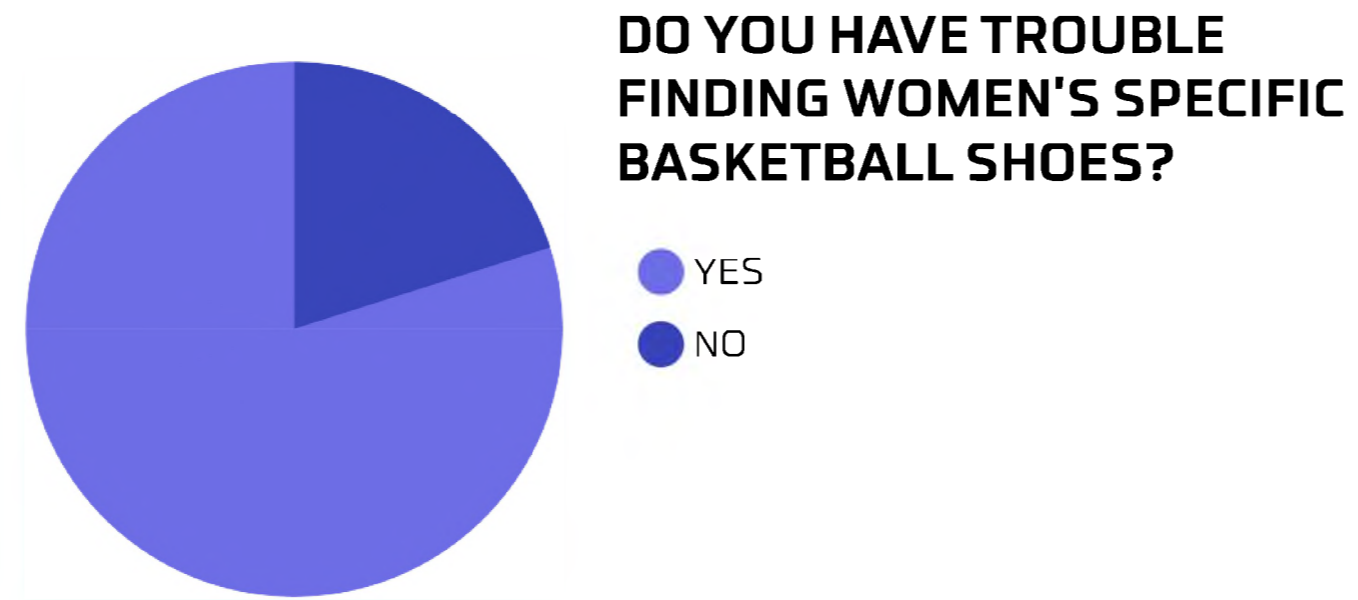
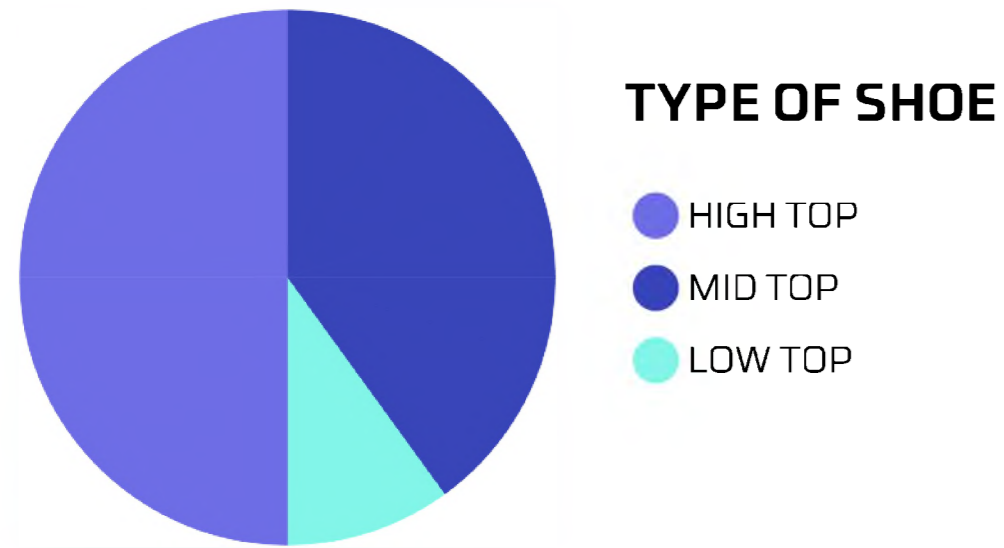

“THERE IS ONLY LIKE 1 PAIR THAT EXISTS”

90%

OF ATHLETES EXPERIENCE PAIN DURING/AFTER SPORT BECAUSE OF THEIR FOOTWEAR

WHERE?

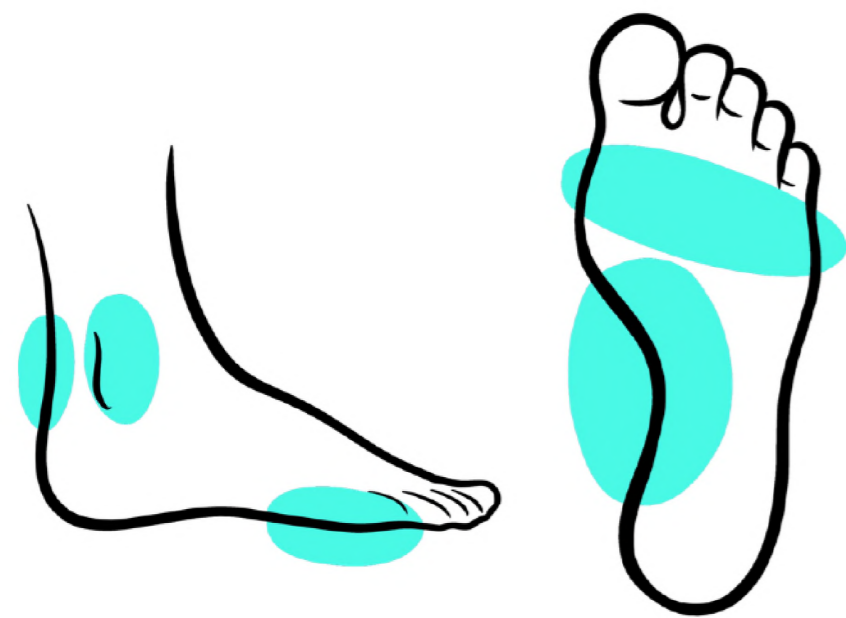

- 1 AESTHETICS
- 2 BREATHABILITY
- 3 FIT/SIZING
- 4 DURABILITY

ARE DIFFERENT SHOES NECESSARY FOR OUTDOOR BASKETBALL?

- "Never wear your indoor shoes outdoors because you will wreck the indoor floor and your shoes."
- "Yes because the bottoms would get worn out much quicker on a concrete or pavement surface than indoors, also for indoors they need to stick to the ground well and not be slippery."
- "Yes, for the different surfaces of the ground."
- "Not really. I wear running sneakers if I'm outdoors so I dont ruin my pair of basketball sneakers."
- "Outdoor shoes need to be more durable and more cushioned."

APPAREL USER INSIGHTS

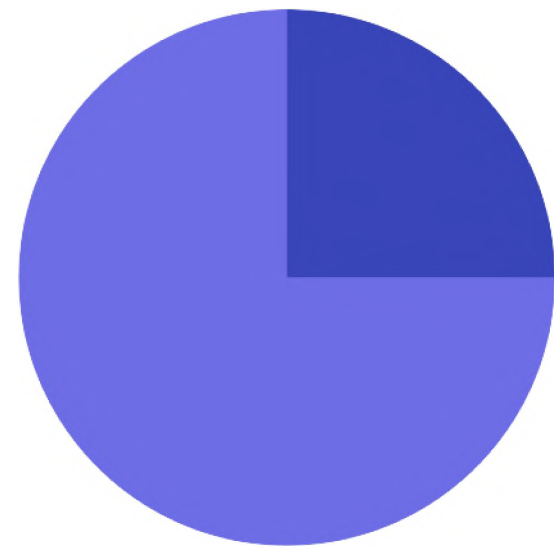

DO YOU WEAR BRACES OR ADDITIONAL EQUIPMENT?

- YES
- NO



WHAT ADDITIONAL EQUIPMENT DO YOU WEAR?

- KNEE PADS/SLEEVE
- SHOOTING SLEEVE
- ANKLE BRACES

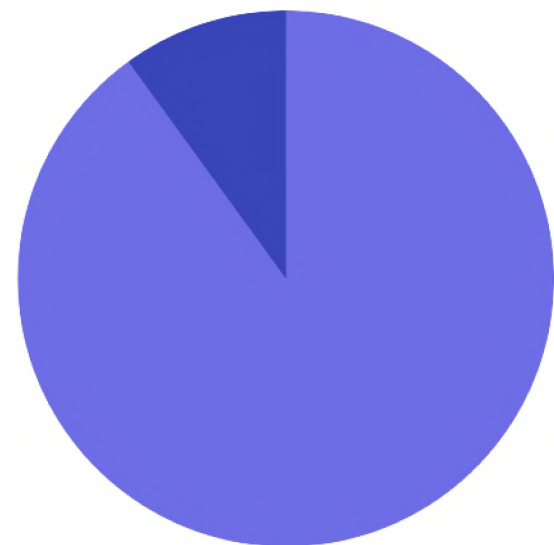

DO YOU WEAR DIFFERENT APPAREL FOR DIFFERENT GAME STYLES?

- YES
- NO

WHAT TYPE OF APPAREL DO YOU WEAR WHILE PLAYING BASKETBALL?

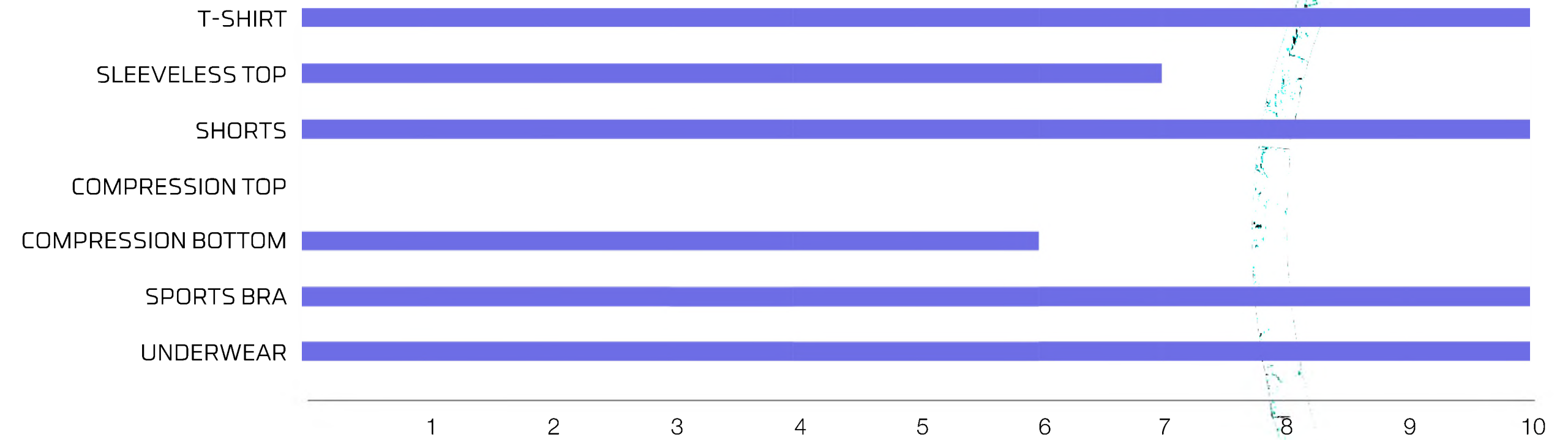

- 1 MOBILITY
- 2 FIT/SIZING
- 3 LIGHTWEIGHT
- 4 BREATHABILITY



I LIKE THE PROPRIOCEPTION OF COMPRESSION SHORTS,

BUT WEAR SHORTS ON TOP FOR MORE

COVERAGE



FOOTWEAR BASELINE

Baseline products chosen based on user insight results

1 UA FLOW BREAKTHRU 2

\$119.99 / W8.5



- Breathable engineered mesh upper strategically supported by no-sew films for enhanced comfort & flex.
- Women's-specific build with half-bootie & molded collar for incredible fit & anatomically correct support.
- External TPU wing for heel lockdown & lateral containment.
- UA Flow cushioning technology is super-light, bouncy & provides insane grip.
- Proprietary, 3D-molded TPE-blend sockliner with low compression set for energy return & longevity.

2 NIKE AIR ZOOM G.T. RUN

\$165.97 / M7 (W8.5)



- Nike React technology for an extremely smooth ride.
- The 2-layer upper is made with lightweight mesh for a broken-in feel and a textured haptic print layer for extra durability.
- The thin rubber outsole has curvy ridges that bend and flex to provide traction in multiple directions.
- Rubber is cut away under the arch and perforated to help reduce weight.
- Foam tongue molds to your foot to help reduce lace pressure.

3 ADIDAS EXHIBIT A CANDACE PARKER

\$109.99 / W8.5



- Regular fit for comfort.
- Lace closure for secure lockdown.
- Lightstrike midsole for smooth cushioned feel underfoot.
- Rubber outsole for traction.
- Textile upper with durable and supportive overlays for durability.

APPAREL BASELINE

Baseline products chosen based on user insight results

1

NIKE DRI-FIT LEGEND T-SHIRT

\$25.00 / MEDIUM



- Dri-FIT technology helps keep you dry and comfortable.
- Odor-resistant finish helps the shirt stay fresh.
- Standard fit for a relaxed, easy feel.
- 100% polyester

2

NIKE TEMPO SHORTS

\$30.00 / MEDIUM



- Lightweight woven fabric feels smooth as you run.
- Curved mesh on the sides increases your airflow, helping you stay cool and mobile.
- Elastic waistband with an internal drawcord gives a personalized fit.
- 100% polyester

3

UA LOCKER T-SHIRT

\$25.00 / MEDIUM



- UA Tech fabric quick-dry, ultra-soft for comfort
- Material wicks sweat and keeps athlete dry.
- Anti-odor tech to prevent growth of odor-causing microbes.
- 100% polyester

4

UA PLAYUP SHORTS 3.0

\$25.00 / MEDIUM



- Soft, lightweight knit construction for comfort and breathability.
- Material wicks sweat and keeps athlete dry.
- Anti-pill/anti-pick finish for extra durability.
- 100% polyester

PERFORMANCE TESTING

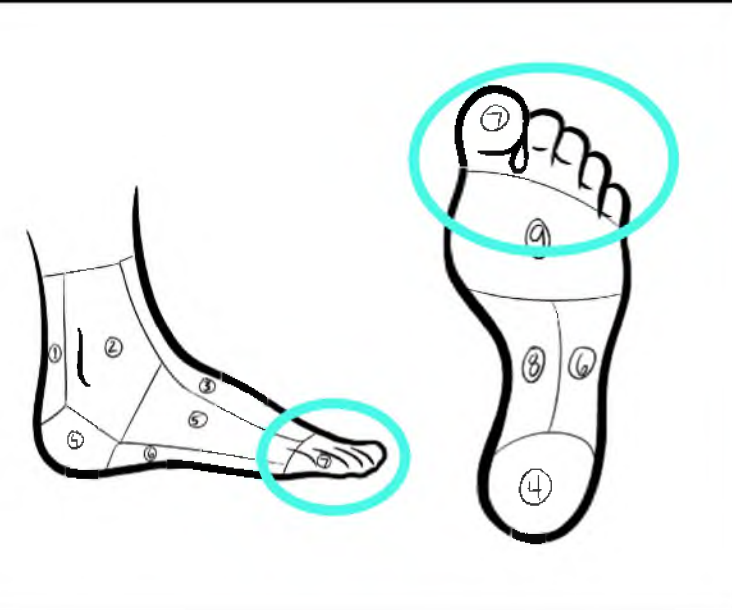
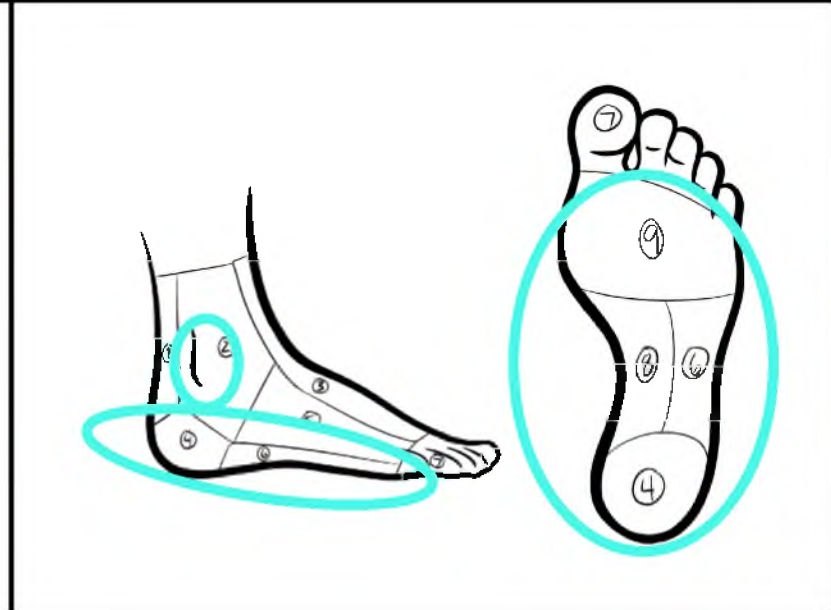
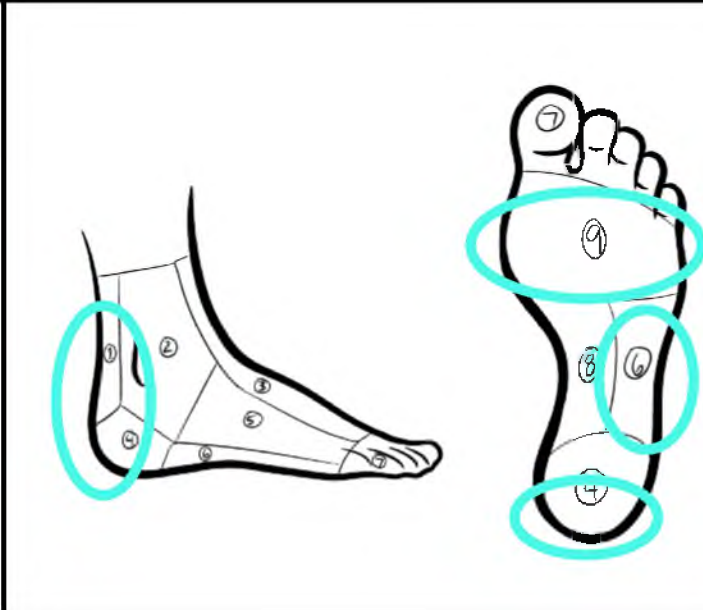
SCORES OUT OF 7			
	UA Flow Breakthru 2	Adidas Exhibit A	Nike Air Zoom GT Run
Comfort	5.7	2.0	5.3
Cushion	6.3	1.0	6.0
Durability	5.7	3.0	5.7
Breathability	5.3	2.3	6.3
Support	5.7	1.0	6.0
Pain Points			

TOTALS	5.74	1.86	5.86
---------------	-------------	-------------	-------------

UA FLOW BREAKTHRU 2

"The arch of my foot felt supported. They were very squishy and my foot did not feel like it was suffocating."

"My toes felt like they were sliding forward as I ran around and shuffled/jumped/pivoted despite this being the size I normally wear."

"Very comfortable and supportive. I wouldn't choose these because there are cooler looking shoes out there."

"Cushioned bottom and good flexibility. Soft and cushioned upper part but my toes were a problem."

ADIDAS EXHIBIT A

"Felt like a board under my foot and they were uncomfortable to run in."

"Soles were hard and uncomfortable."

"Not cushioned and low top...wouldn't wear these because I have bad ankles."

"They felt heavy and were stiff so I'd assume they are durable?"

NIKE AIR ZOOM GT RUN

"Very comfortable and supportive. It felt like I had a bounce to my step as I ran. The arch of my foot felt supported and comfortable."

"They look cool and are preferred size. The only thing I'd say is that the bottom felt hard and around the ankle felt cushioned."

"Cushioned and felt like I was propelling off the ground. I like the height of these shoes. They seem very breathable too."



APPAREL RESEARCH

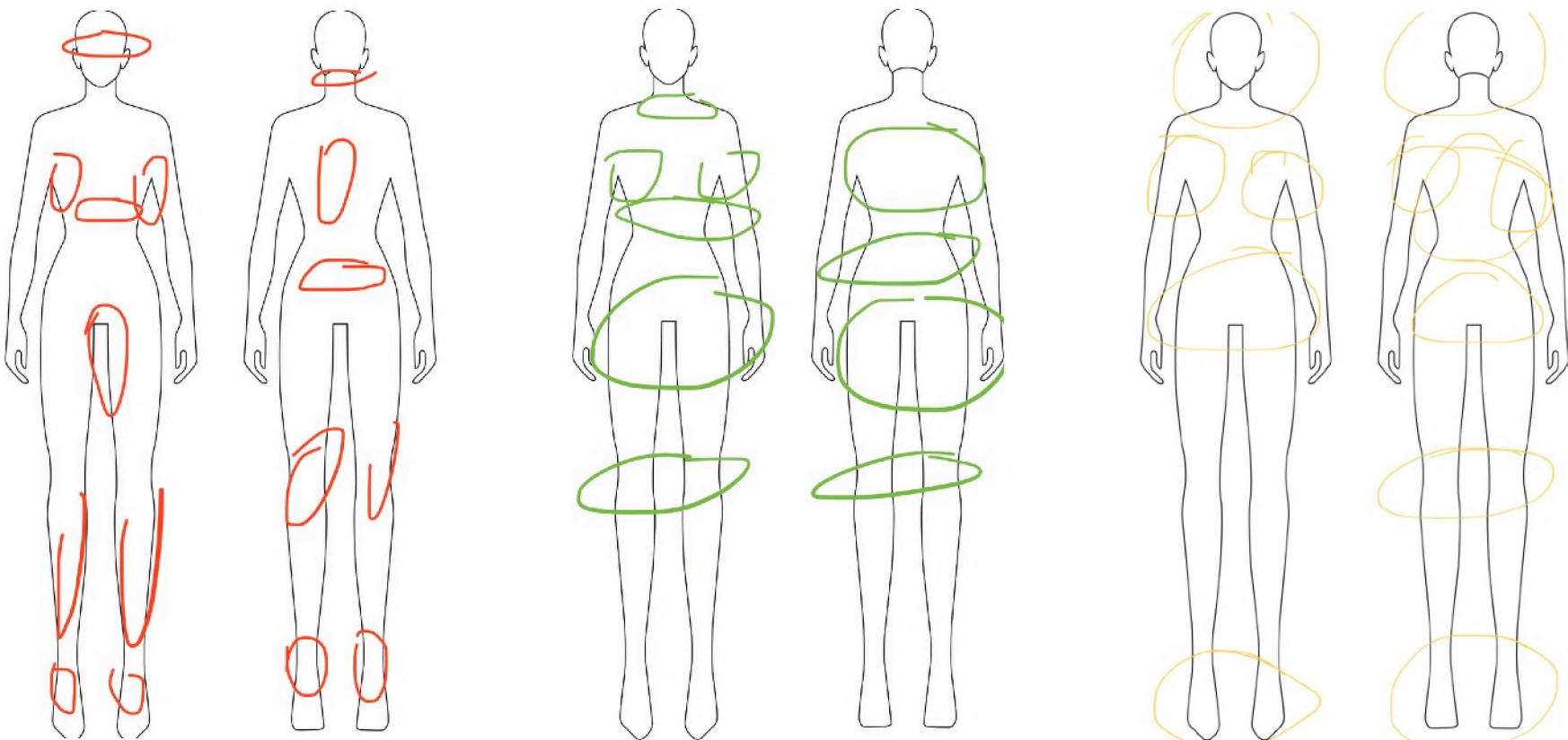

IMPACT MAP

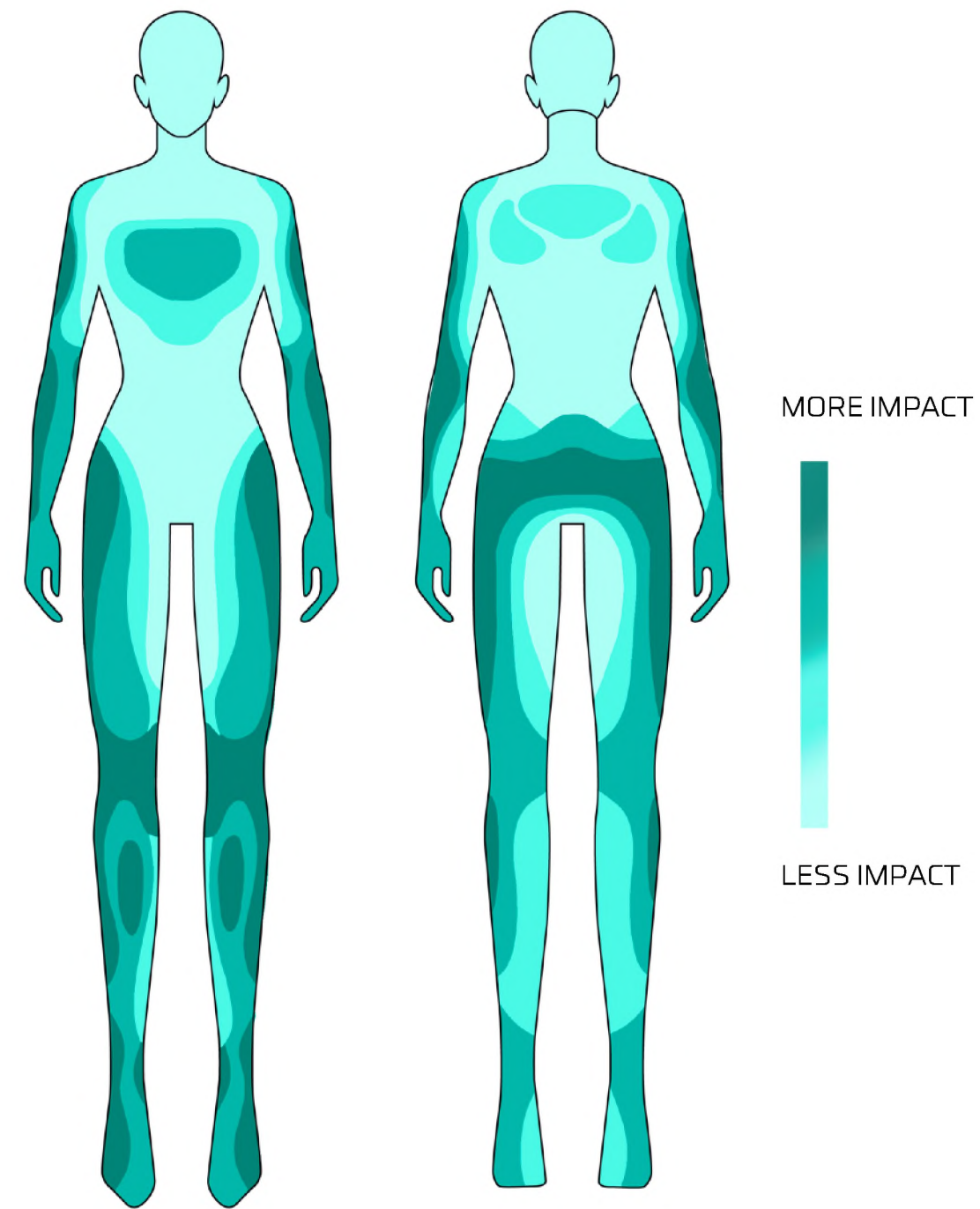

SWEAT MAP

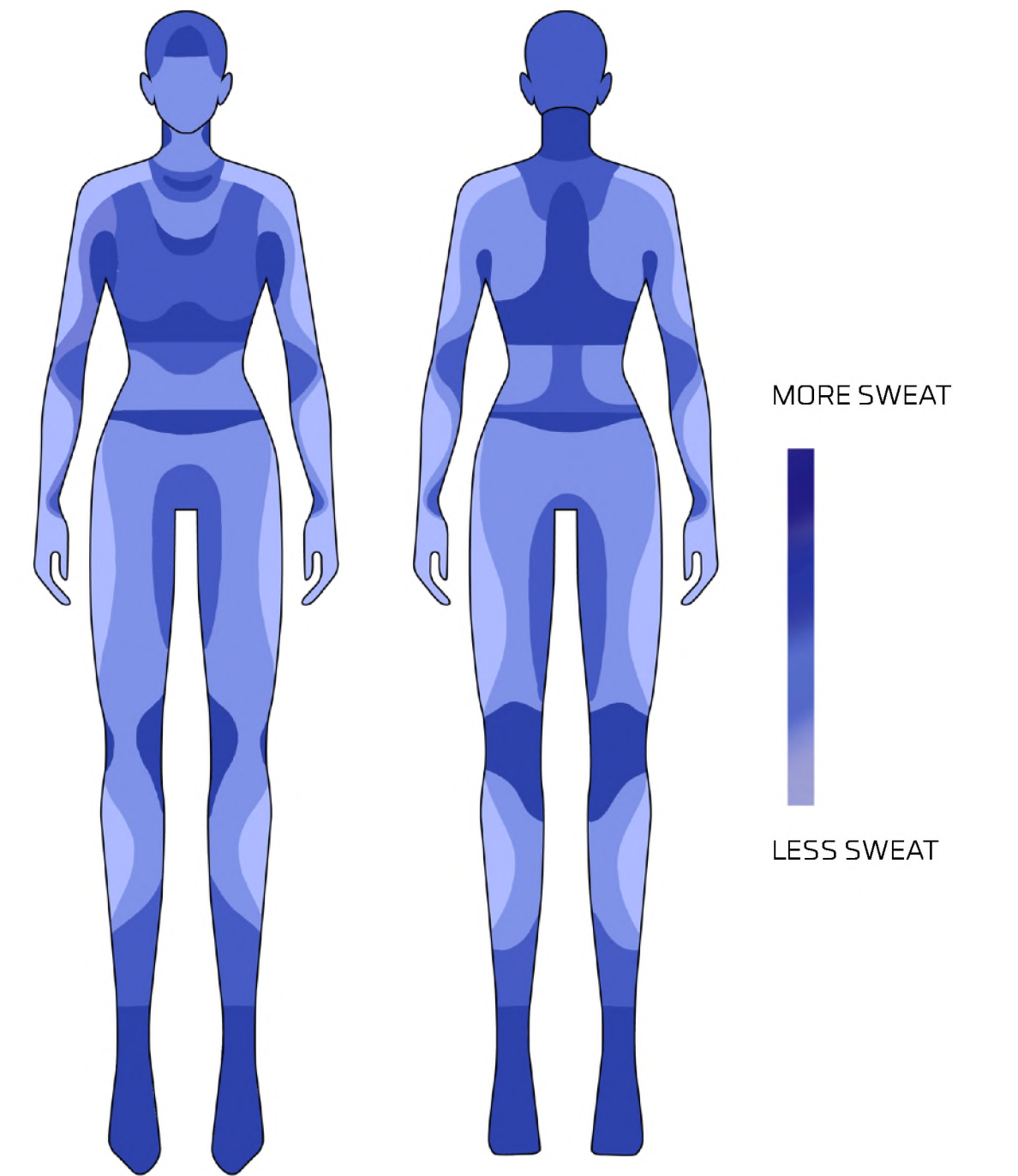

FOOTWEAR RESEARCH

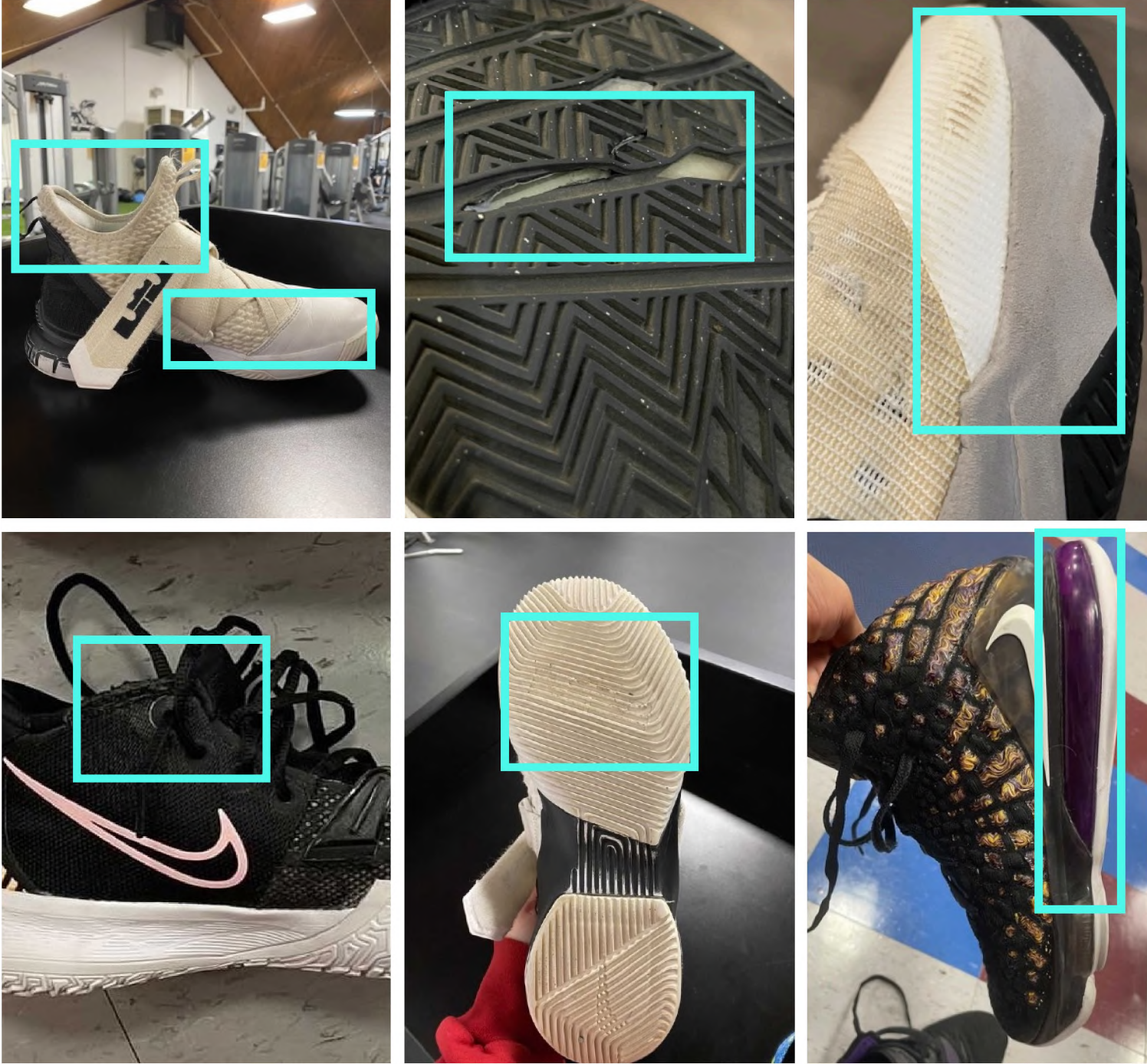

WEAR PATTERN MAP

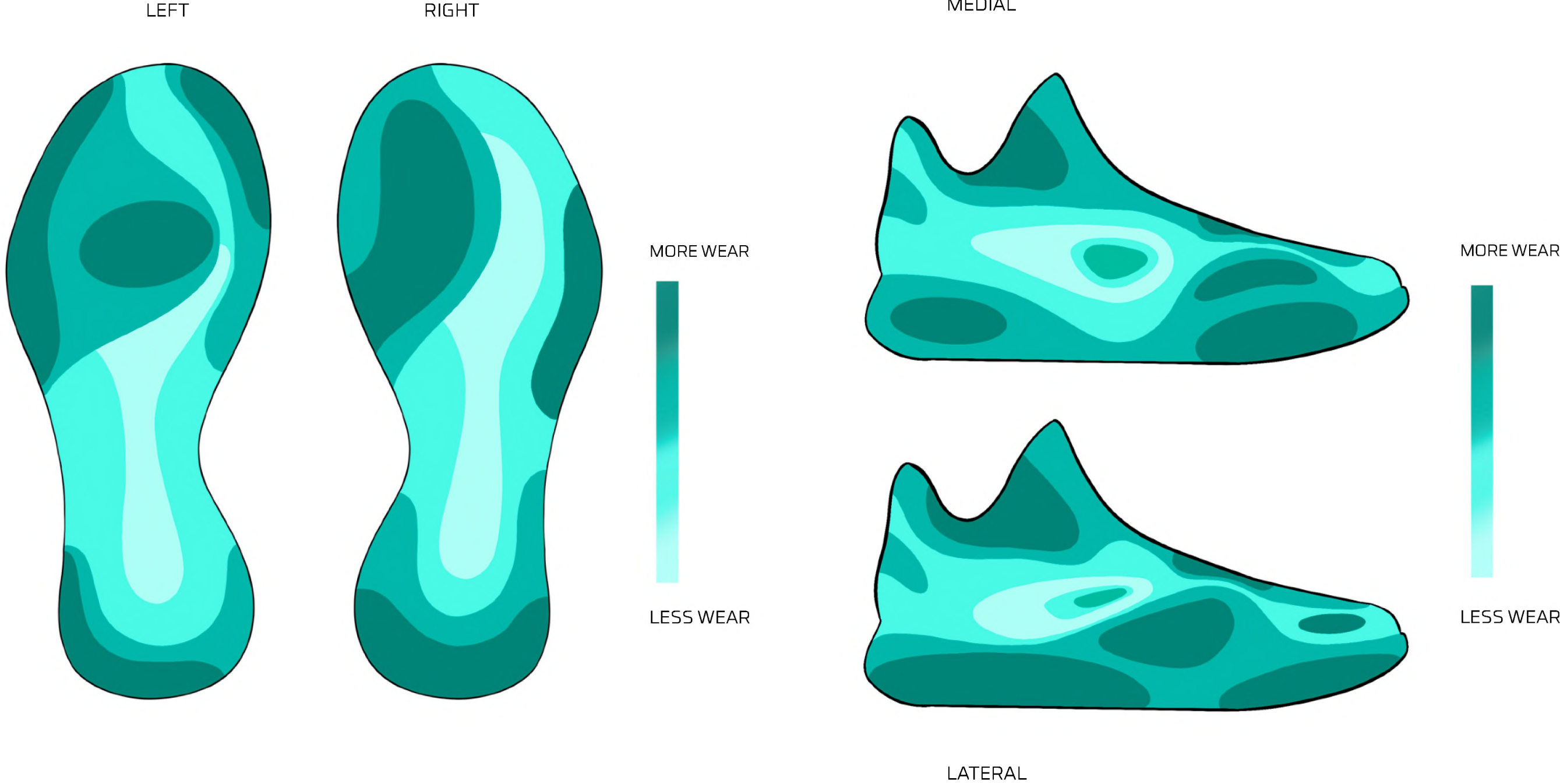

A black and white photograph of a basketball hoop and backboard mounted on a brick wall. The backboard is perforated, and the hoop is visible in the center. The scene is dimly lit, with shadows cast on the wall.

**HOW MIGHT WE PROVIDE DURABLE AND FLEXIBLE PROTECTION
FOR FEMALE BASKETBALL ATHLETES DESIGNED TO HELP THEM
PLAY THEIR BEST GAME?**



FIT

ZONED LOCKDOWN



MOBILITY

EASE OF MOTION



DURABILITY

MATERIAL APPLICATION



FIT

5%

BUILD FEMALE-SPECIFIC LAST TO CREATE 3 POINTS OF LOCKDOWN TO AVOID SLIPPAGE WITHIN THE SHOE. SEAM PLACEMENT TO FOLLOW WOMEN'S OUTDOOR BASKETBALL MOVEMENTS.

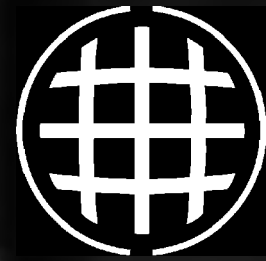

MOBILITY

5%

ADD FLEXIBILITY ZONES TO THE FOREFOOT AND HEEL AREAS OF THE OUTSOLE. TAKE AWAY MATERIAL AT JOINT LOCATIONS WHERE THERE IS A HIGH RANGE OF MOTION.



DURABILITY

10%

PILLING AND FIBER SHEDDING OCCURS AFTER 35 SECONDS. PROTECT AGAINST LONG TERM WEAR SO THE ATHLETE KEEPS THE PRODUCT LONGER.



DURABILITY



FIT / LOCKDOWN

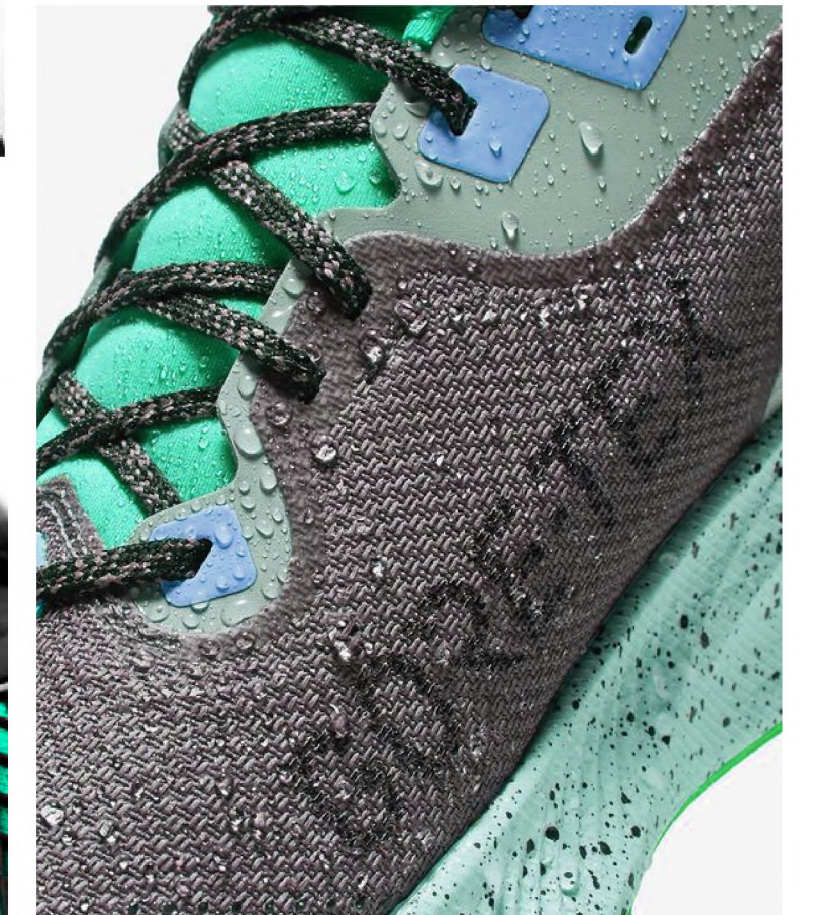
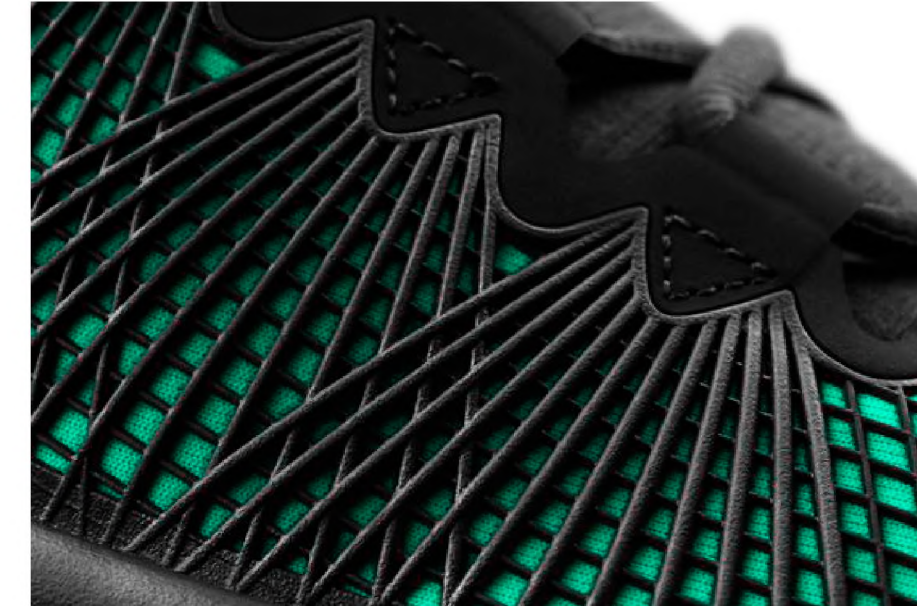

PANTONE NEUTRAL BLACK C PANTONE 877 C PANTONE 437 C PANTONE 7472 C PANTONE 3246 C



MOBILITY

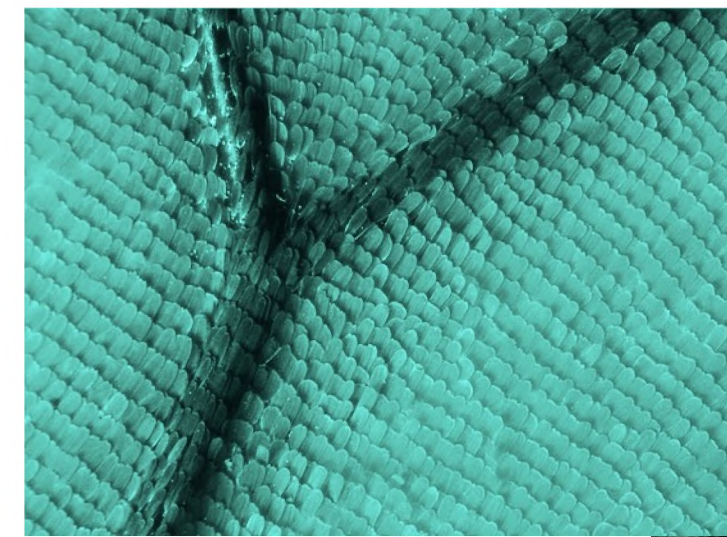
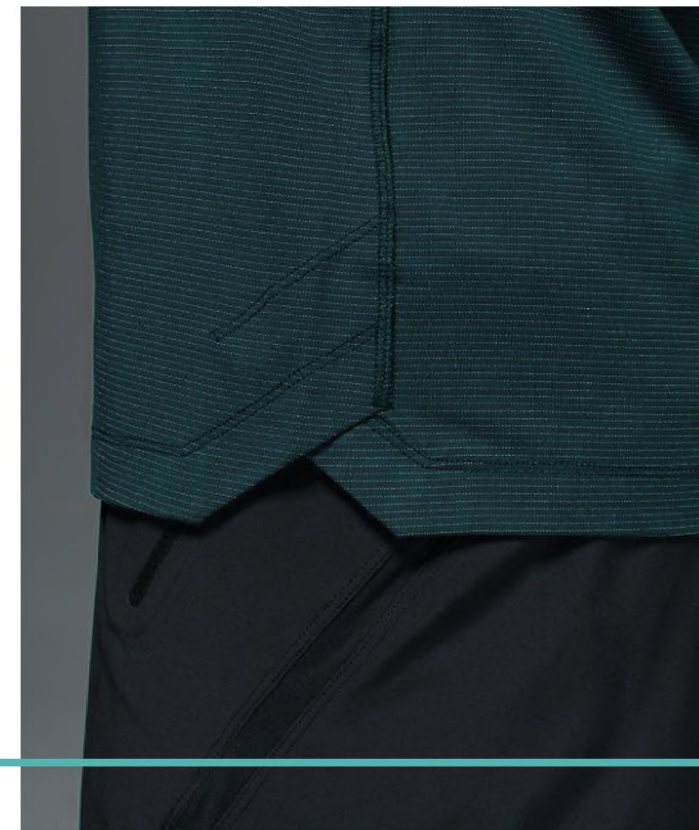



DURABILITY TEXTURE = NEGATIVE OF TRACTION PATTERN

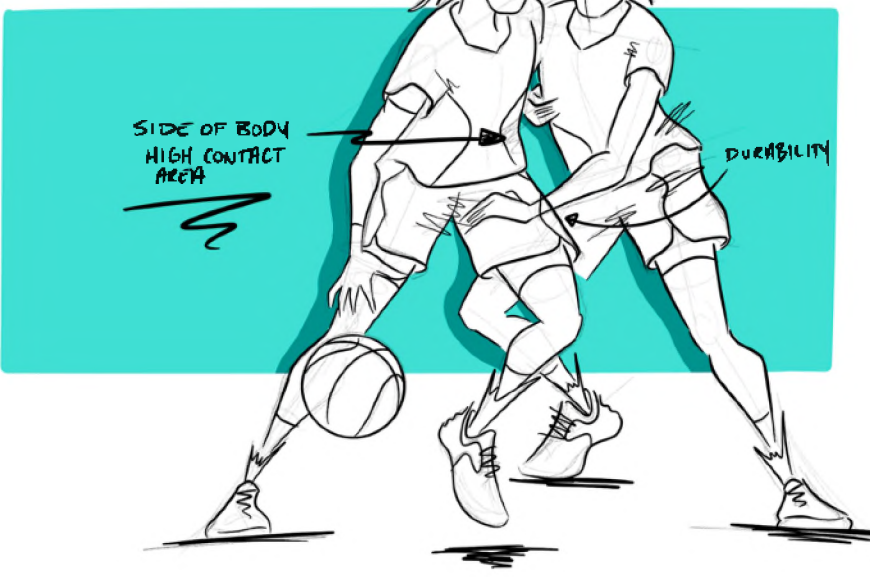
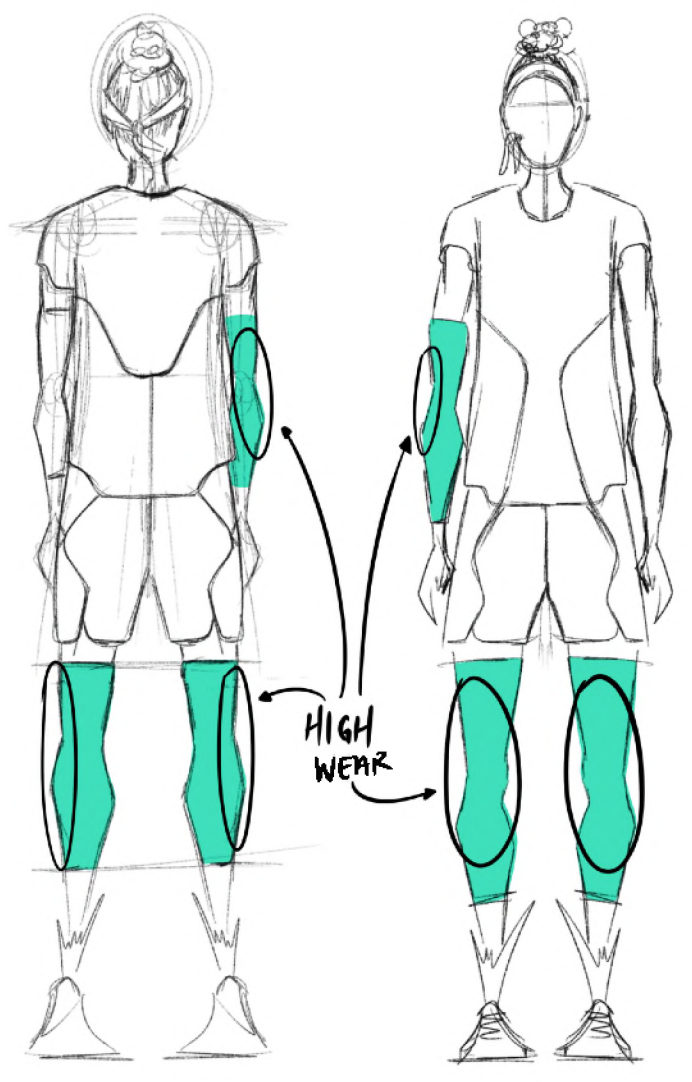
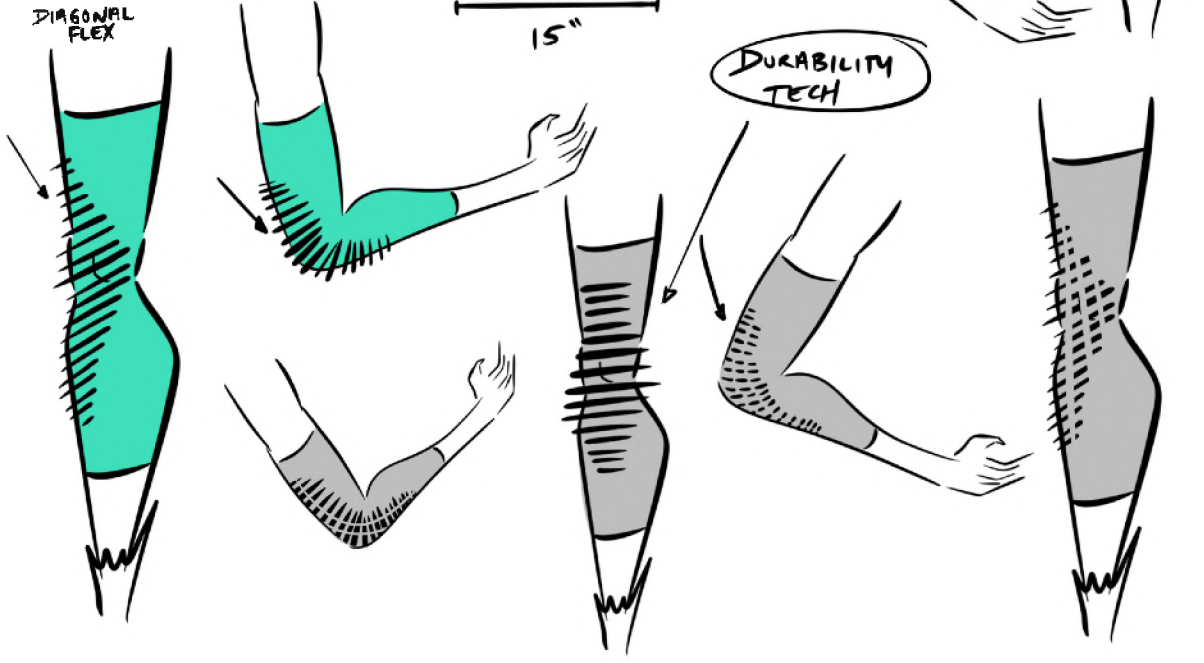
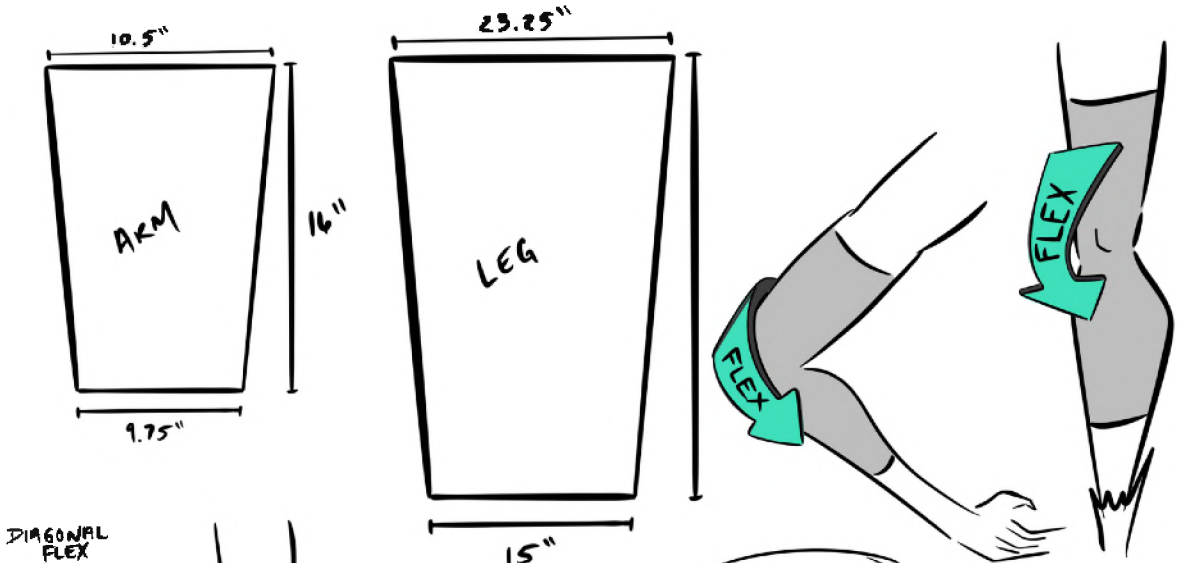
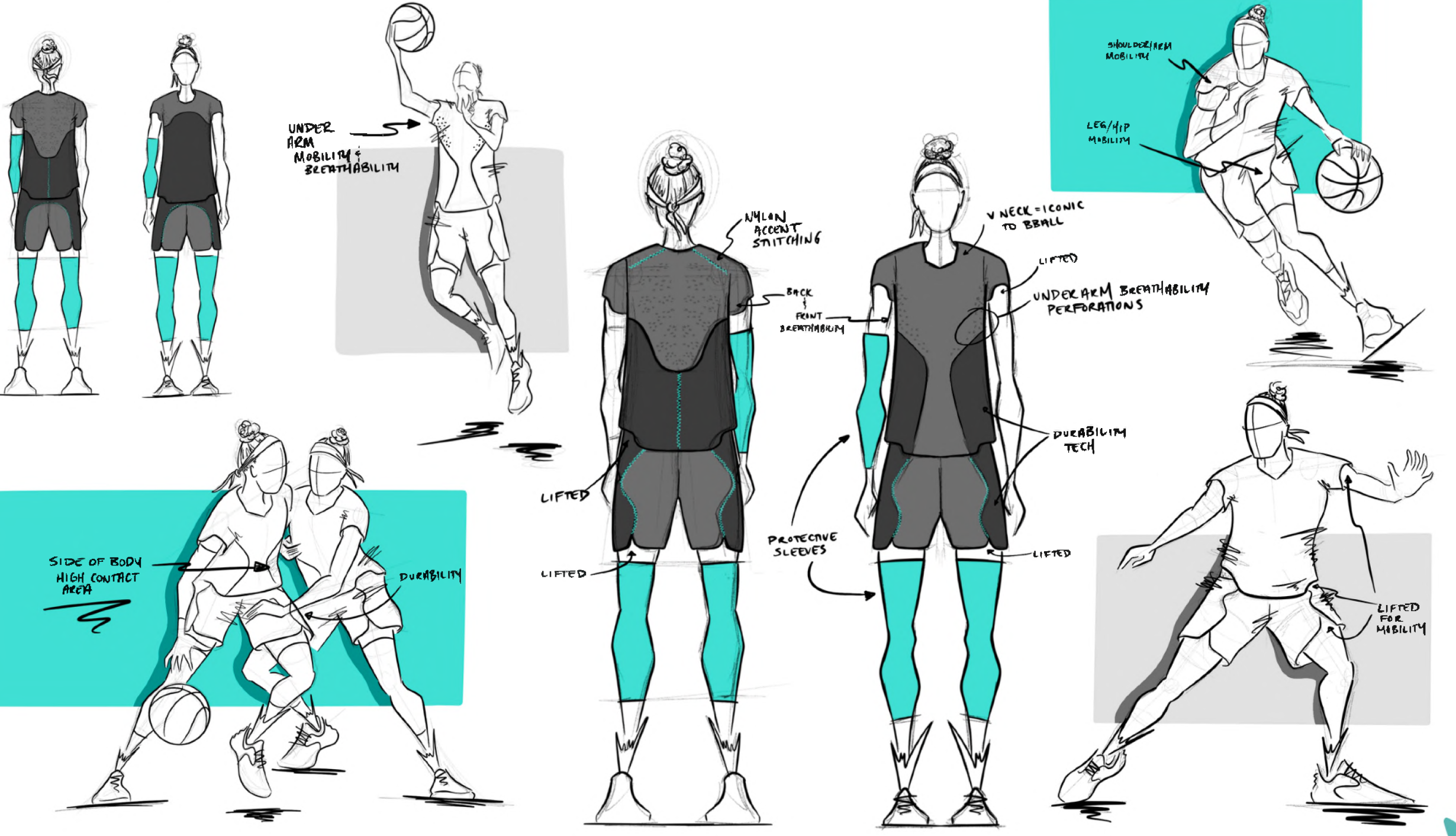
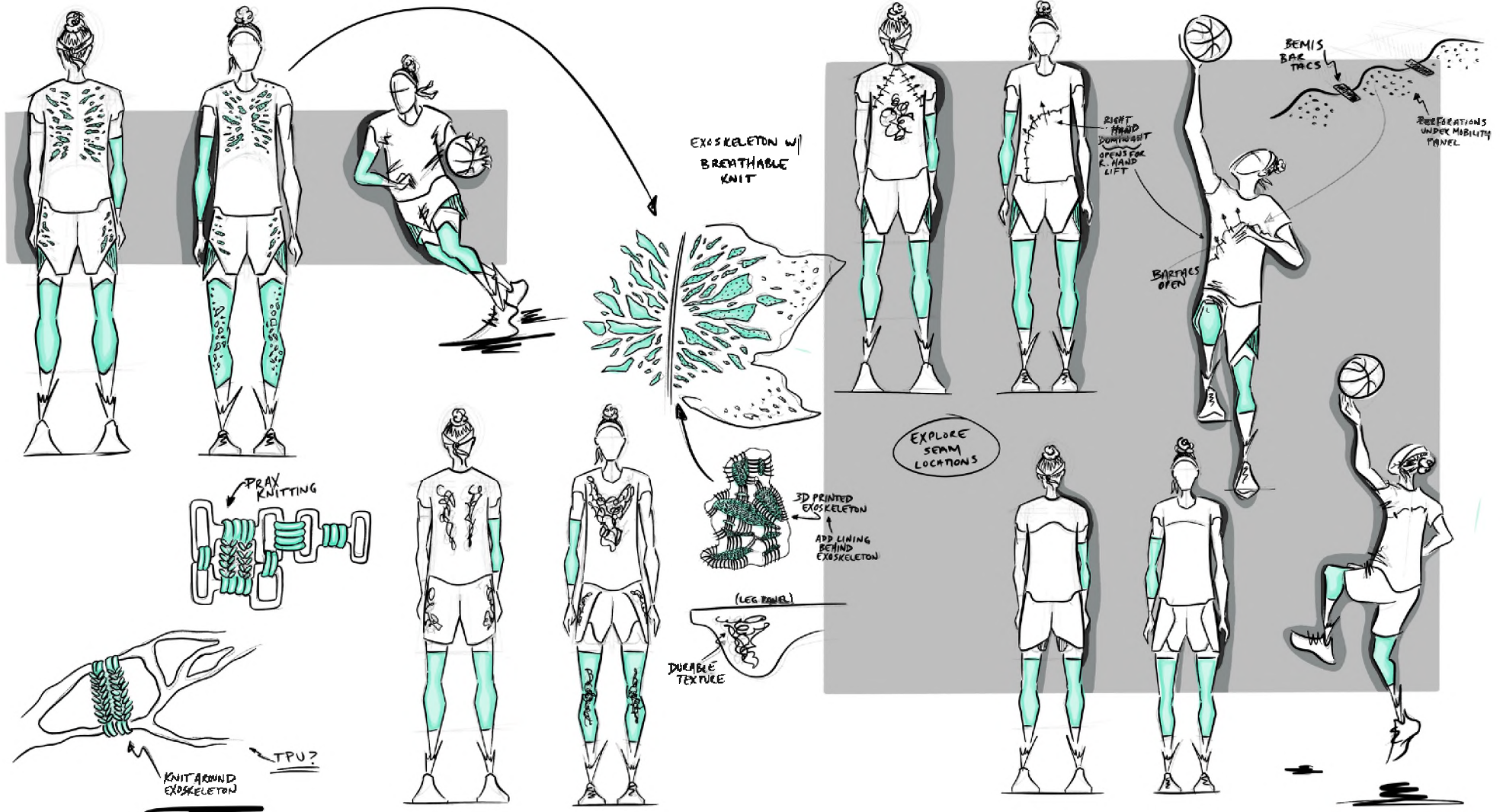
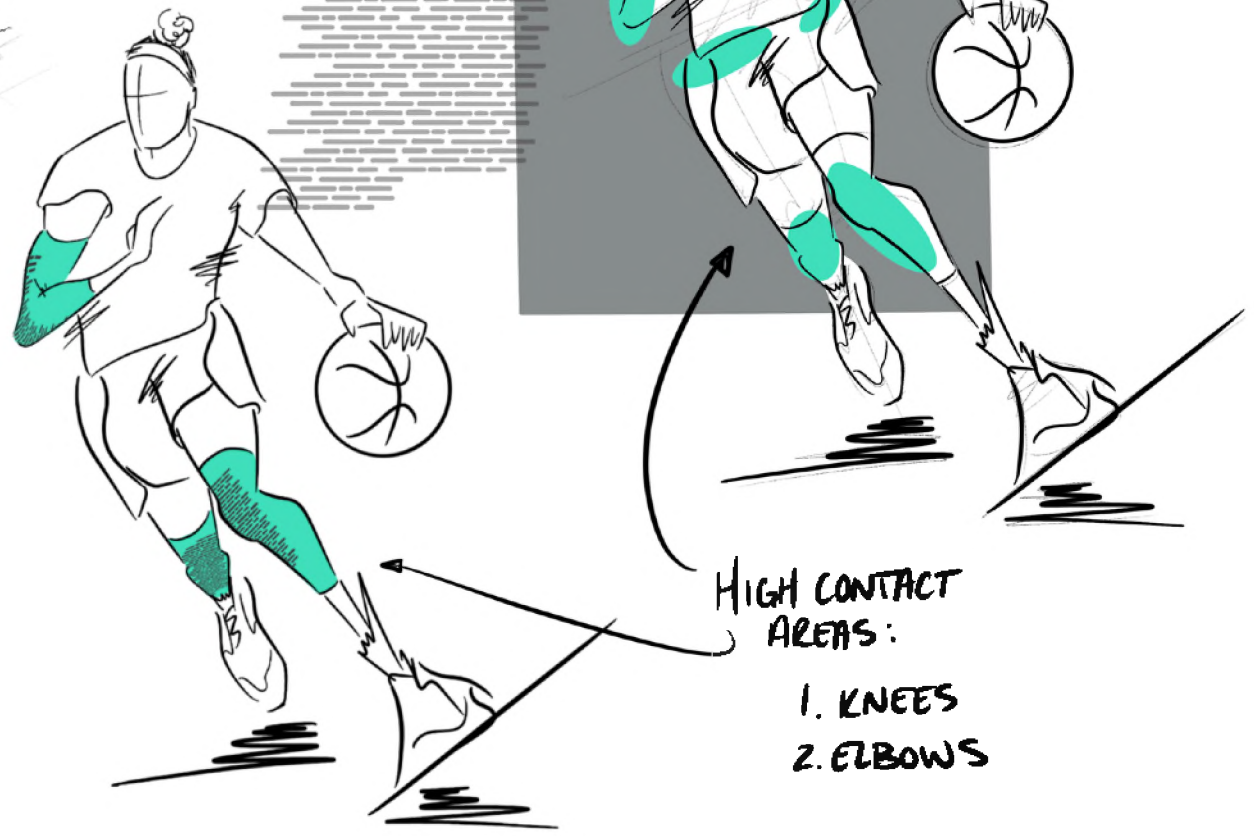
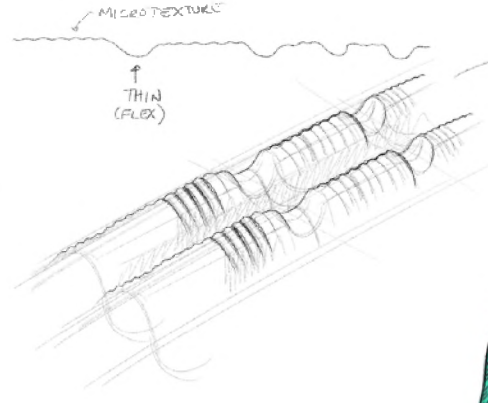
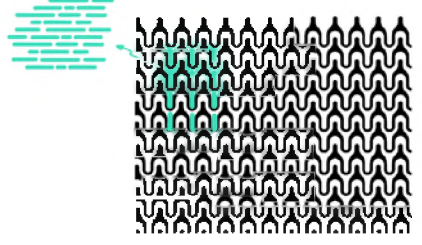

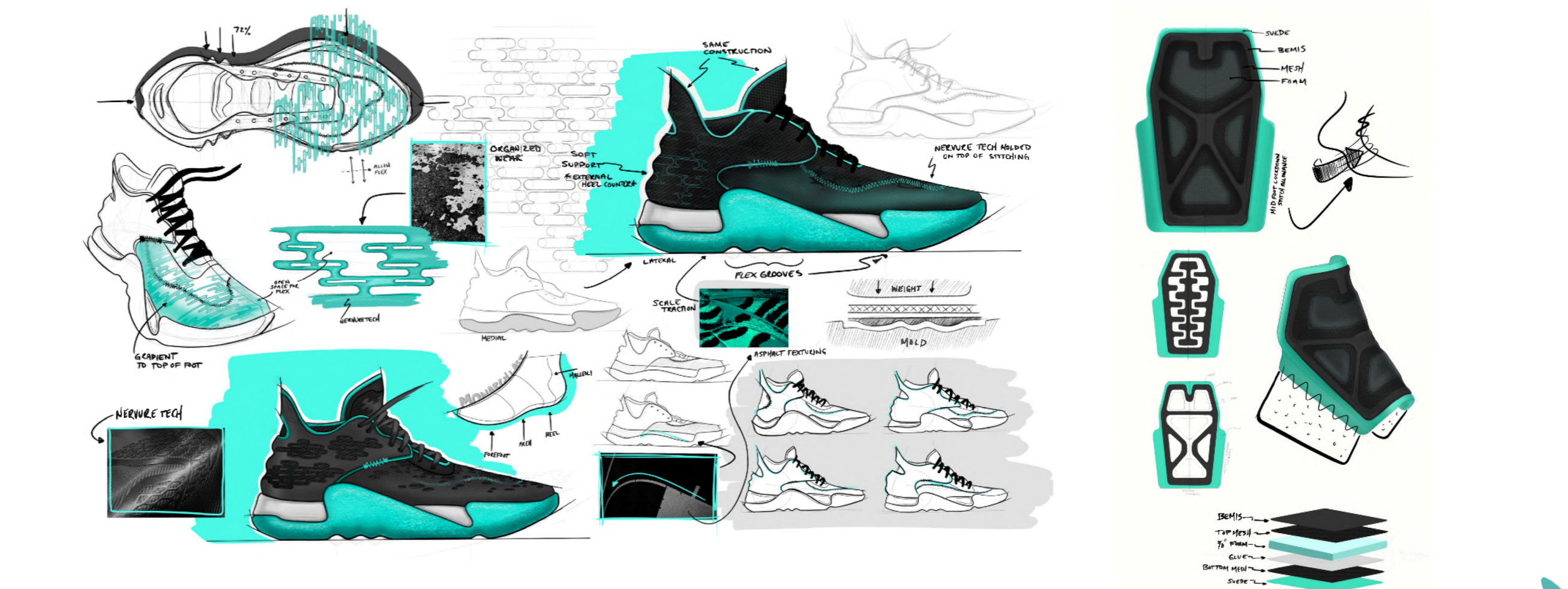
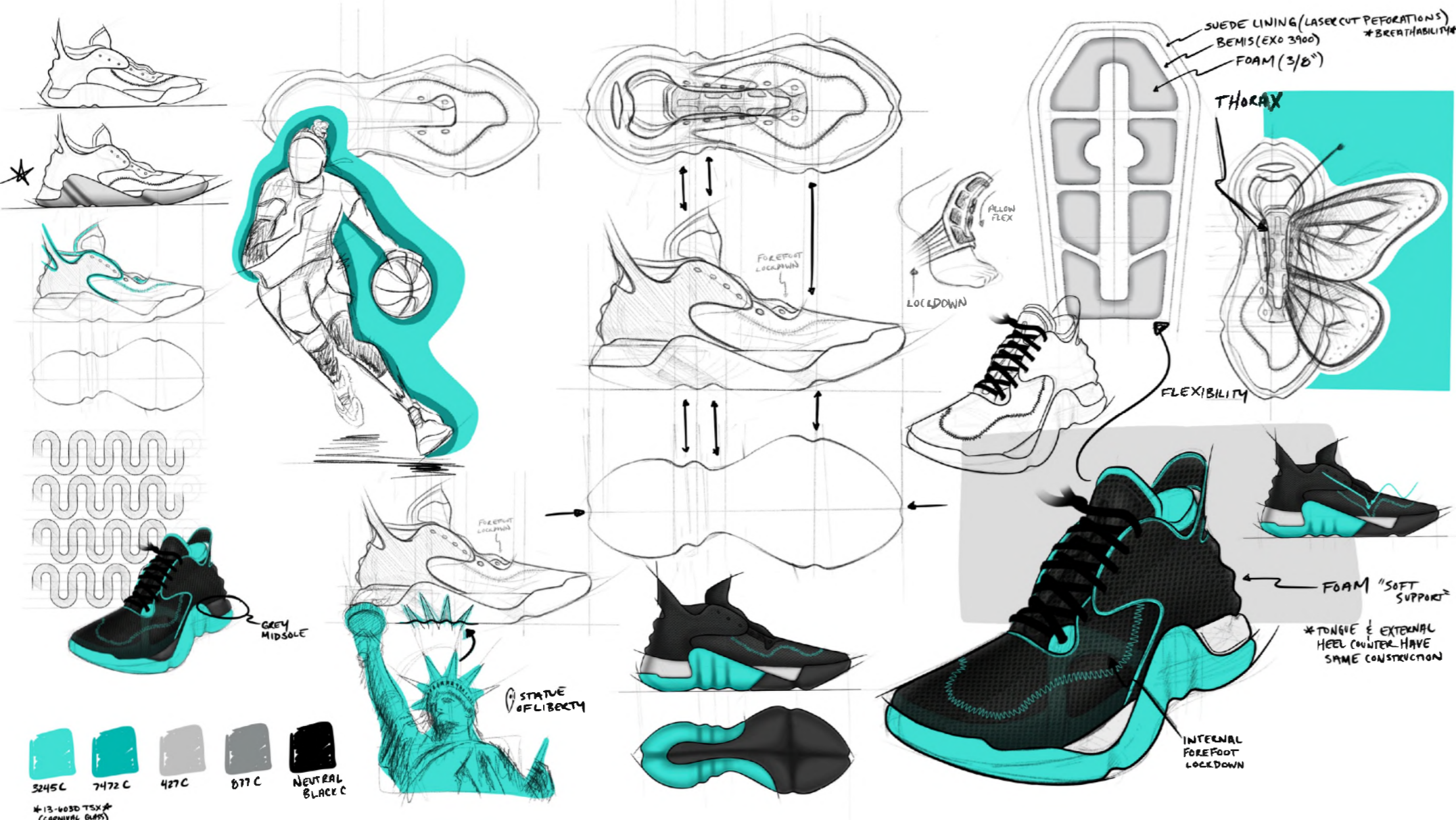
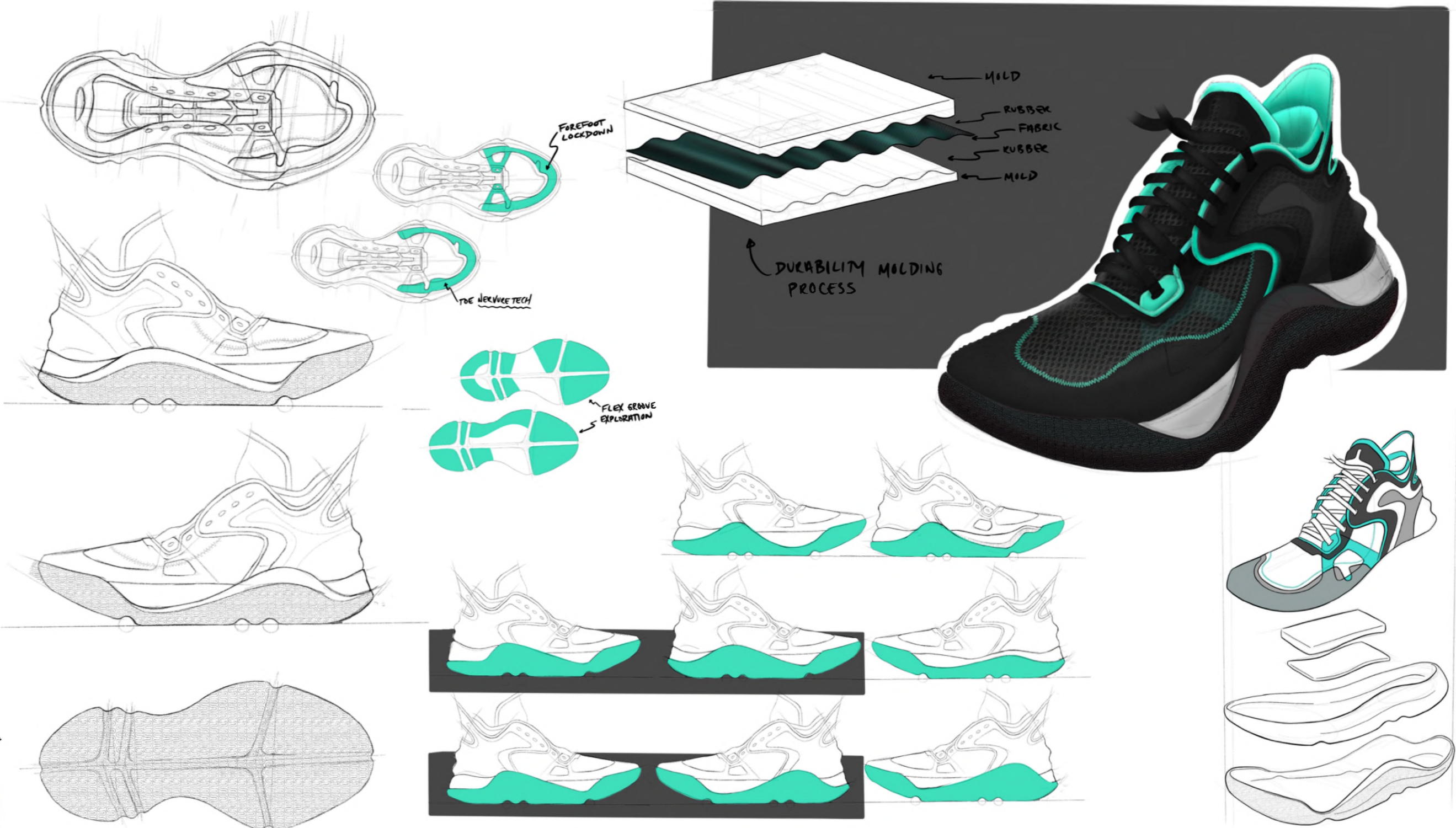
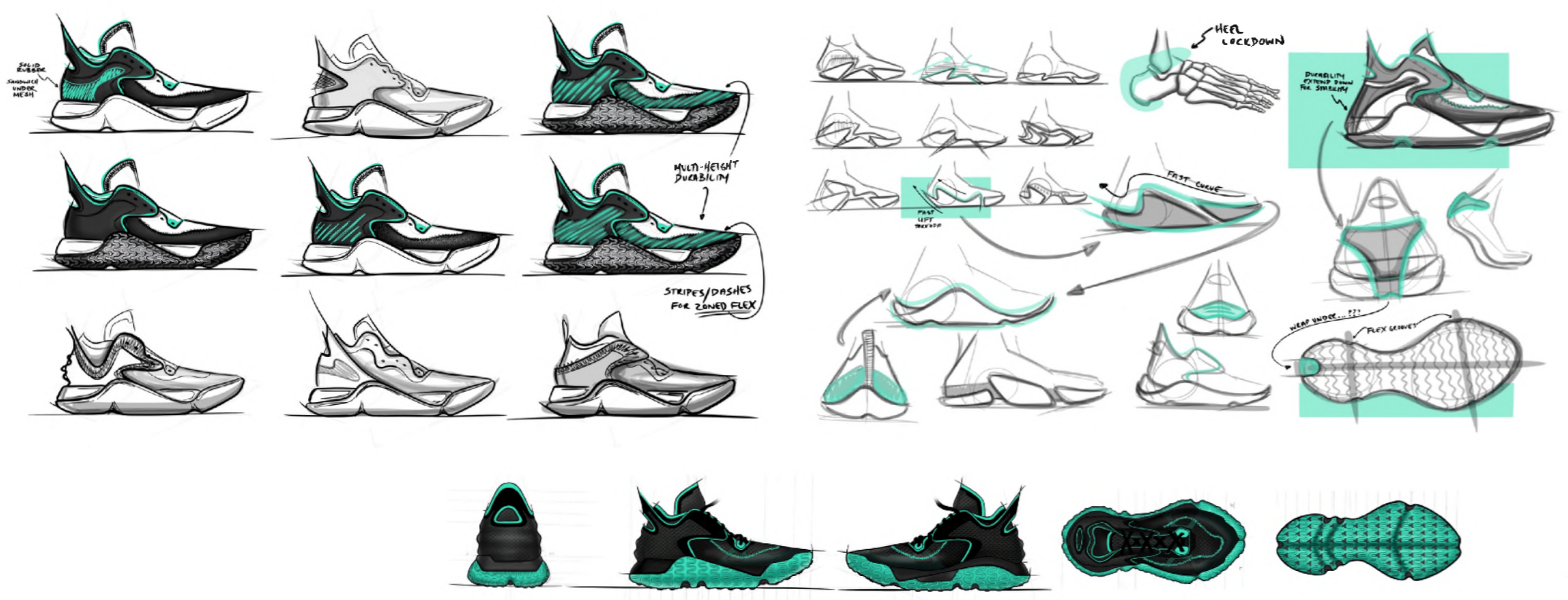



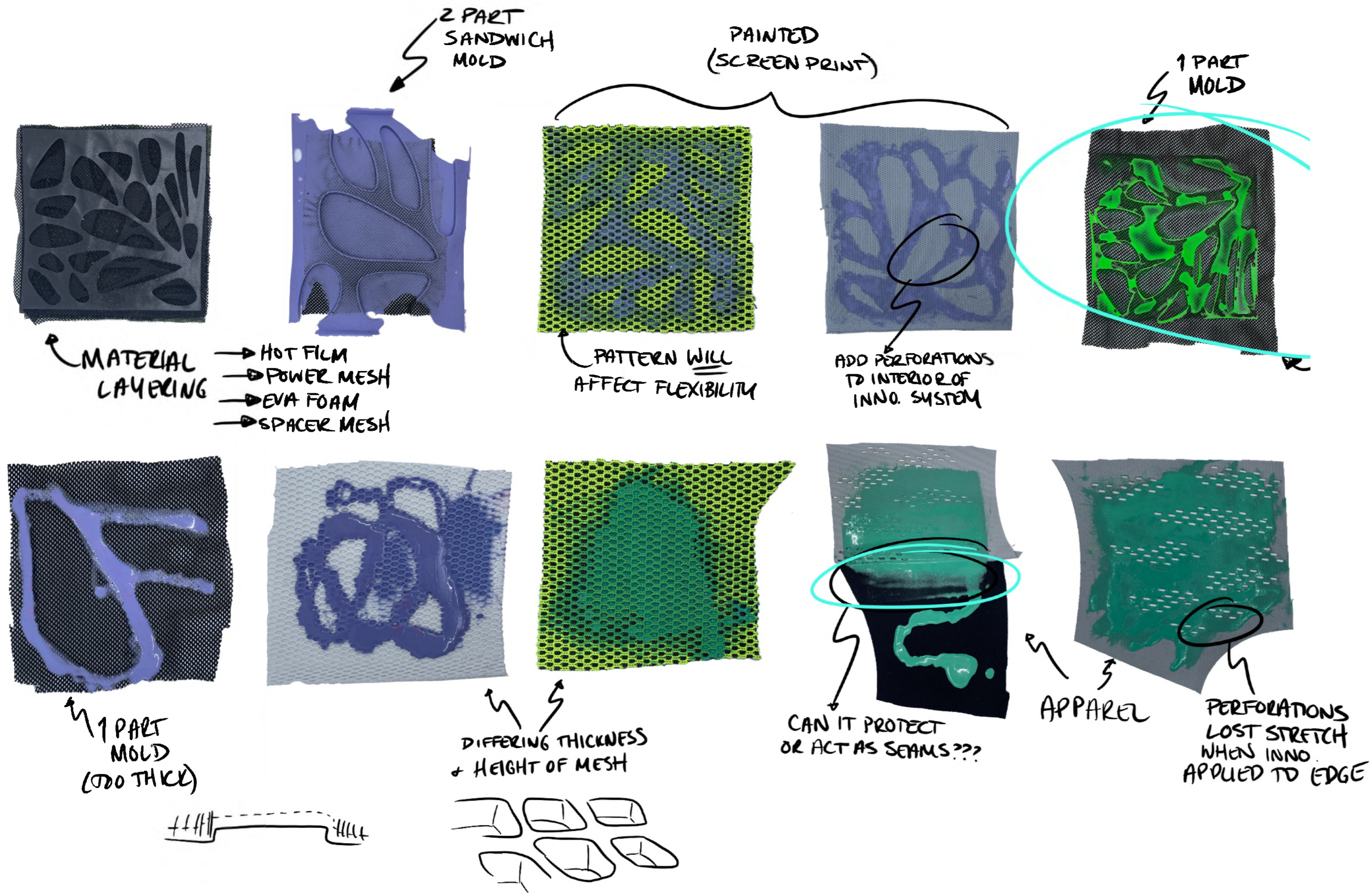











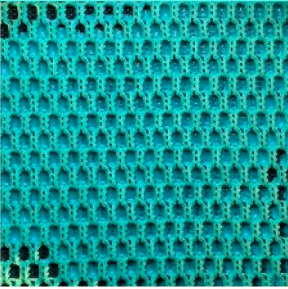



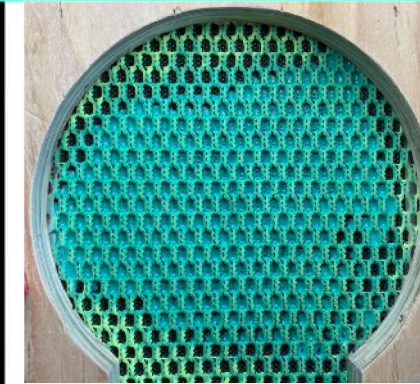
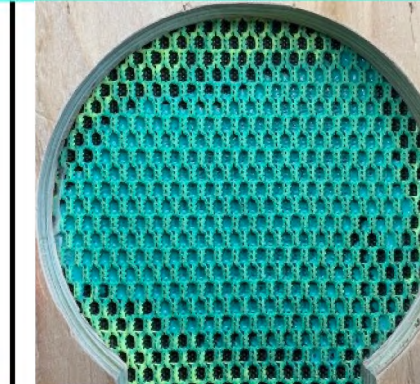
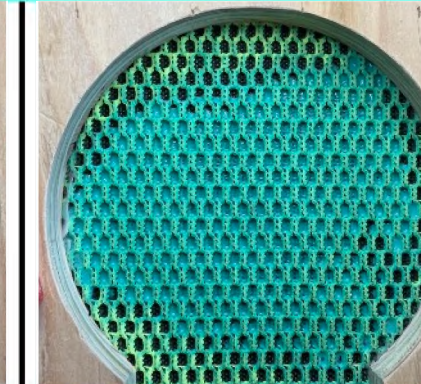
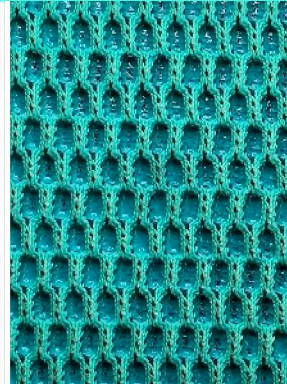

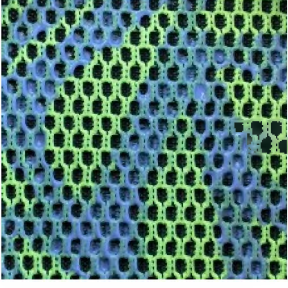





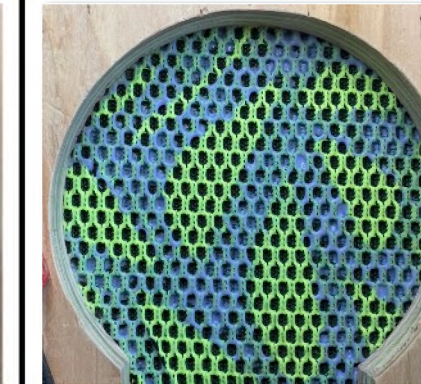
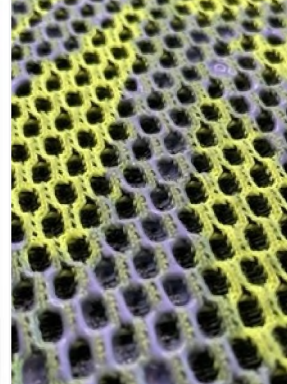
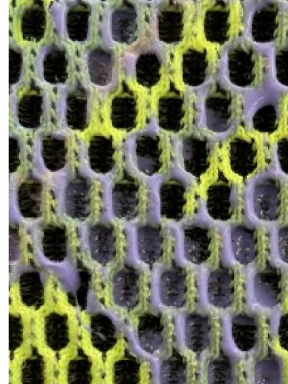



DURABILITY PROCESS



DURABILITY TESTING

MATERIAL (0 s)	10 s	20 s	30 s	40 s	50 s	60 s	FINDINGS / DOCUMENTATION
 <p>TPU FILM TPU / POLY MESH / EVA FOAM</p>							  <ul style="list-style-type: none"> - Mesh failed ~40 sec. - High wear on TPU film.
 <p>URETHANE RUBBER POLY MESH KNIT / RED FLEX 60</p>							  <ul style="list-style-type: none"> - Slight pilling occurred ~50 sec. where rubber thins.
 <p>NERVURE TECH SILICONE POLY MESH KNIT / SILICONE RUBBER</p>							  <ul style="list-style-type: none"> - Pilling occurred ~40 sec. - Silicone rubber wore away more than urethane rubber.
 <p>POLY NERVURE KNIT 100% POLYESTER / SMOOTH-ON</p>							  <ul style="list-style-type: none"> - No noticeable pilling. - Slight wear in silicone rubber.



MONARCH LAST

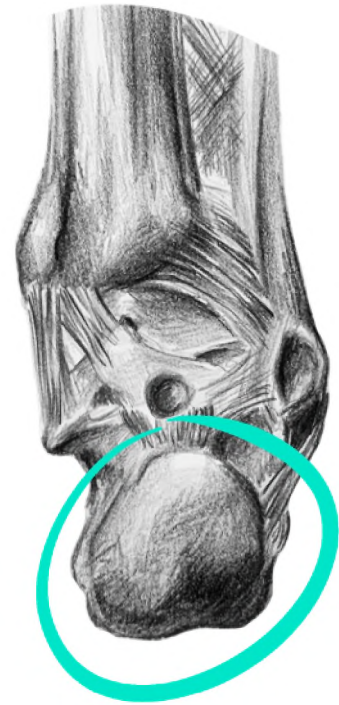

**NARROWER HEEL
LOWER MALLEOLI HEIGHT**

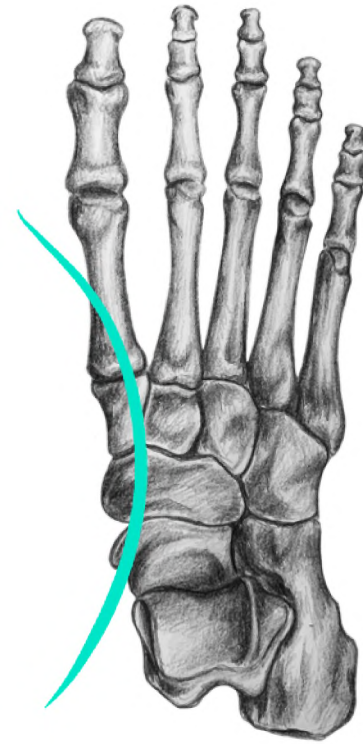

**NARROWER FOREFOOT
SHORTER 5TH MET. TO HEEL LENGTH**

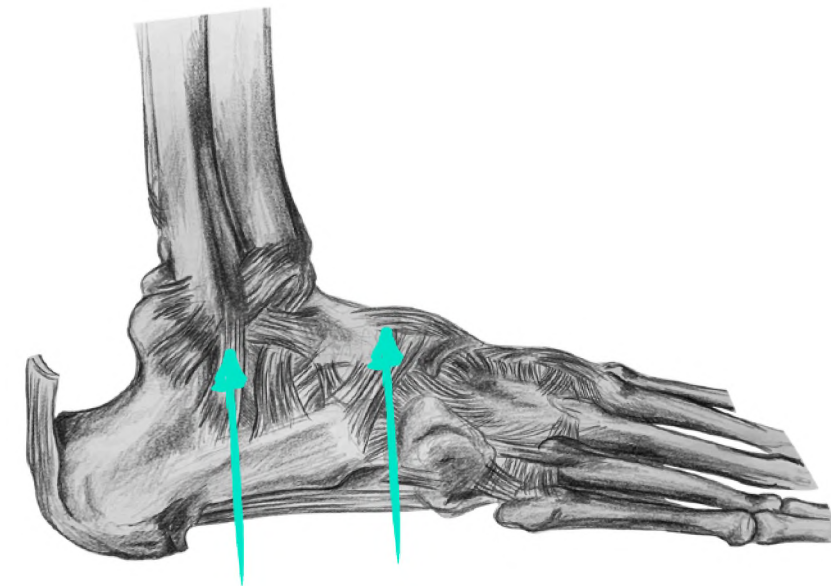

**LOWER MIDFOOT HEIGHT
HIGHER/SENSITIVE ARCH**

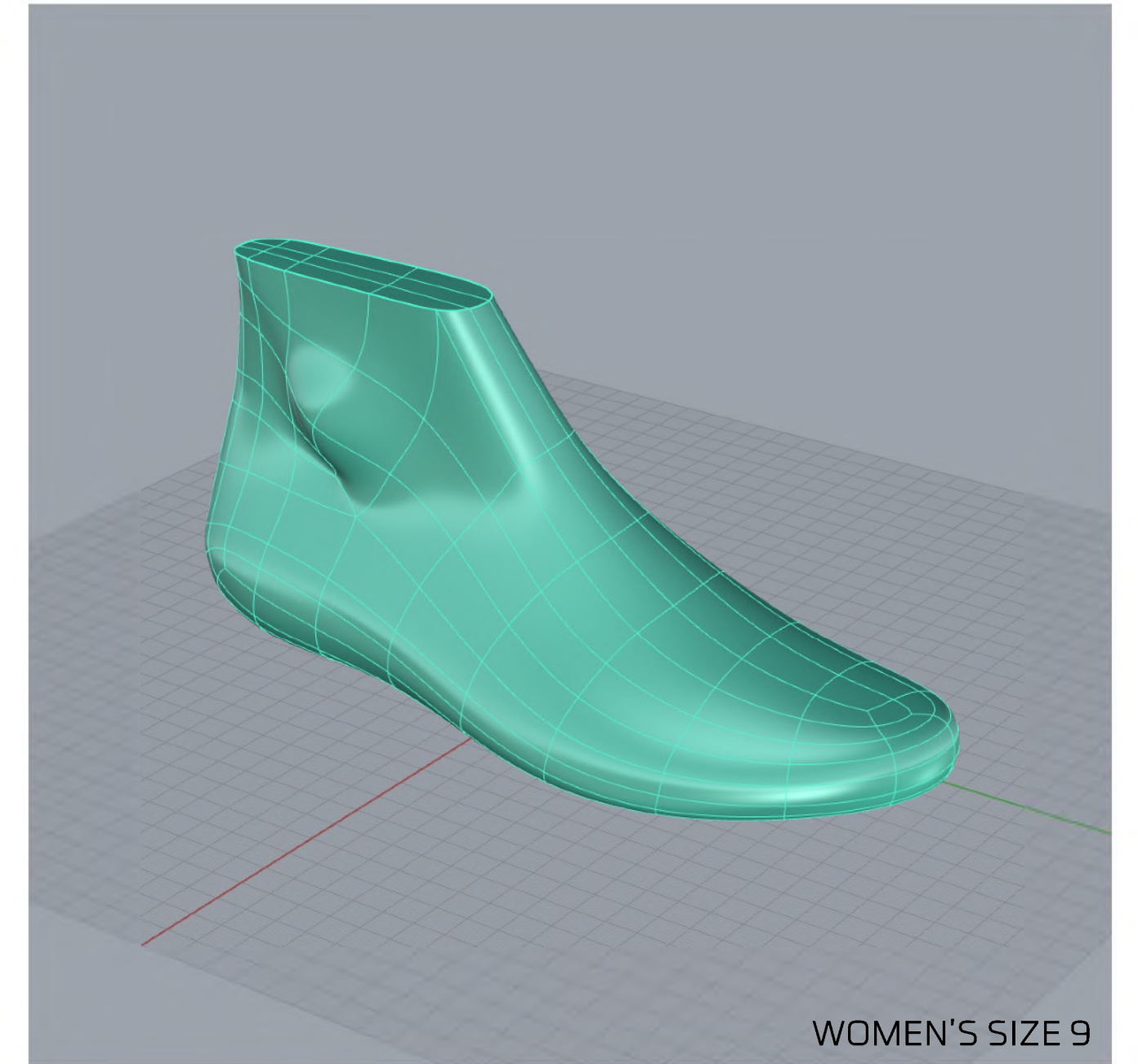

WOMEN'S SIZE 9

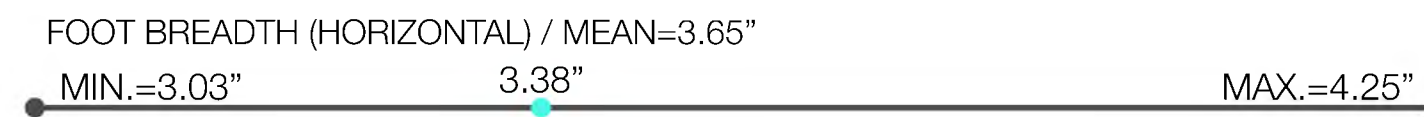
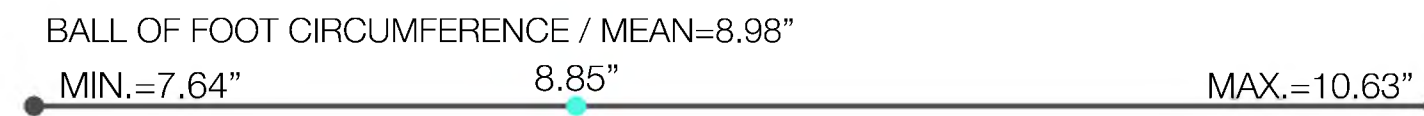
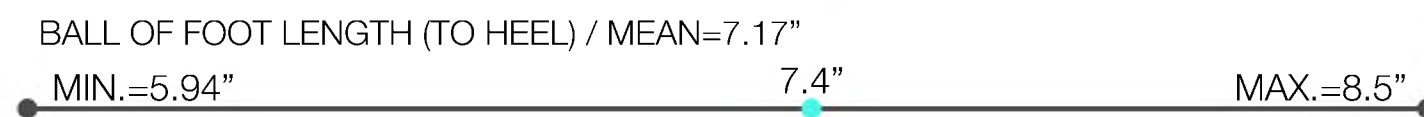

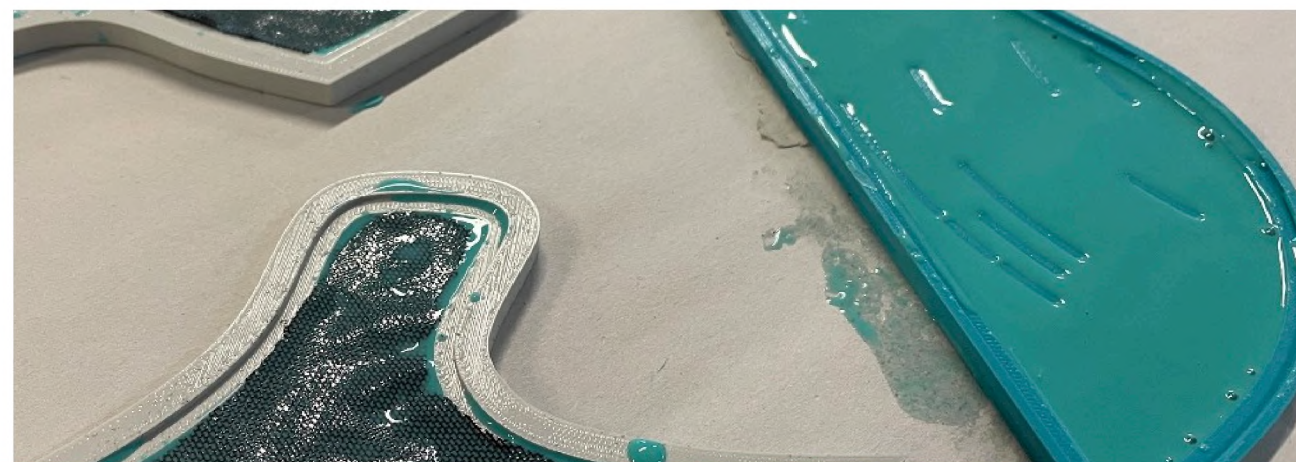

FLEXIBILITY TESTING

RESULTS	
Right 01	27.0 N
Right 02	26.6 N
Right 03	25.6 N
Right 04	26.1 N
Right 05	25.2 N
Average	26.1 N

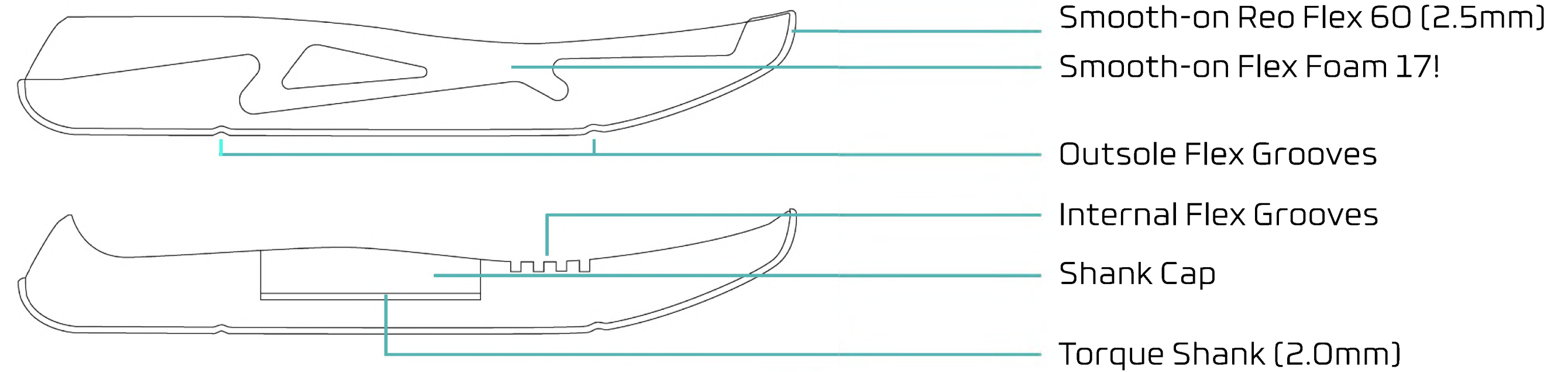

MOBILITY TESTING

METHOD

1 2" grid drawn on baseline product tops and bottoms.

2 Scan athlete in outdoor basketball positions wearing baseline apparel.

3 Identify areas of stretch and bunching of fabric to focus on during prototyping phase.



FINDINGS

BACK

HIP

SHOULDER



MOBILITY TESTING

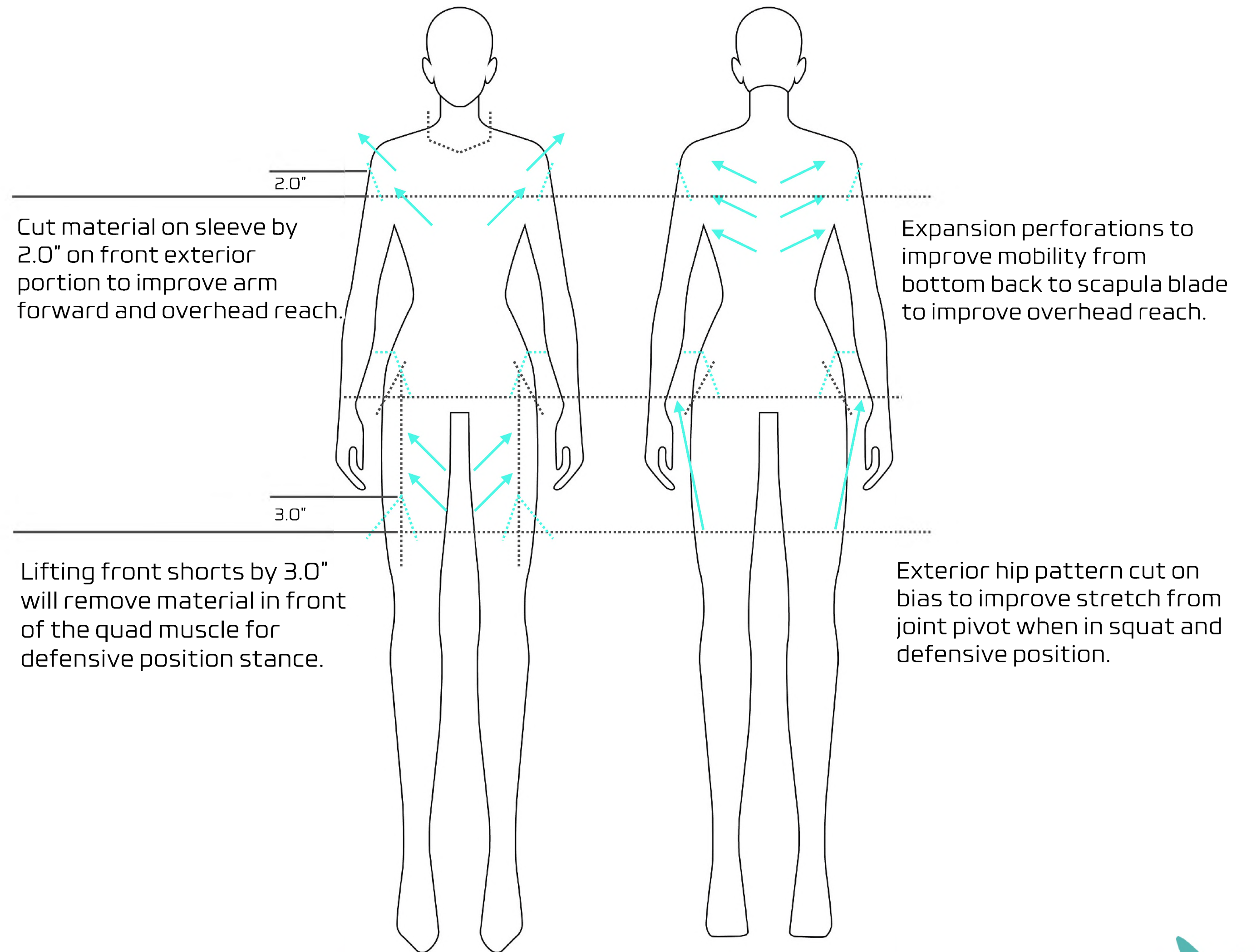
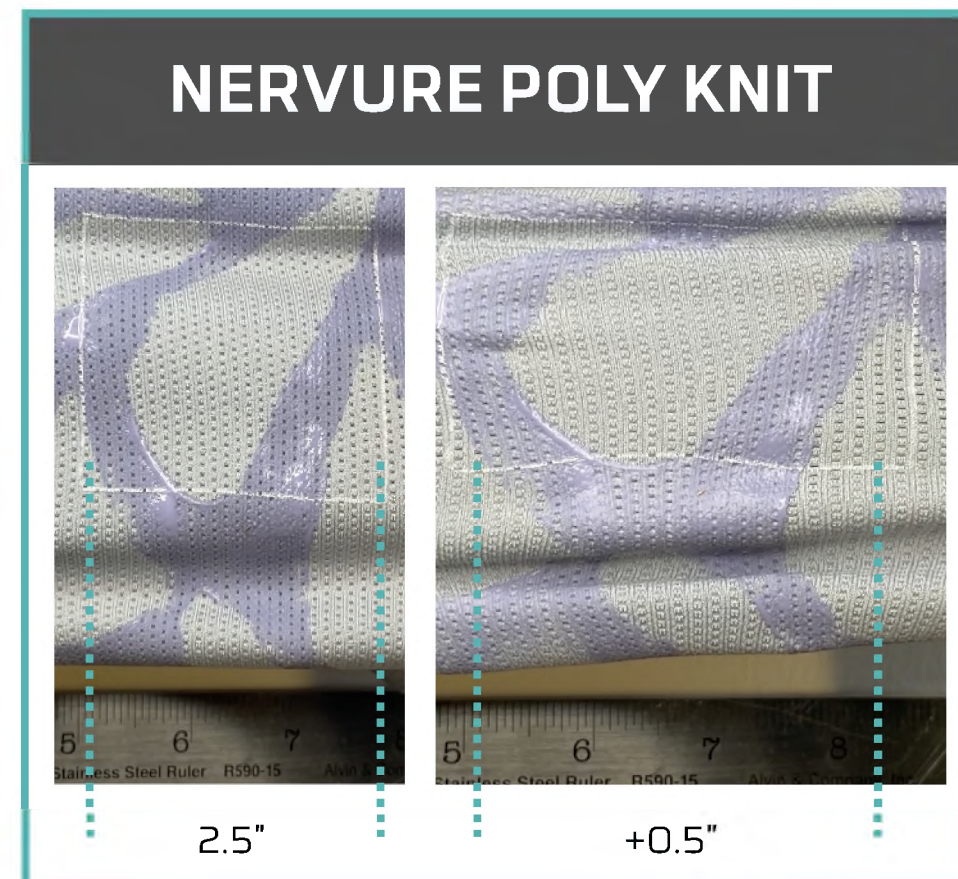
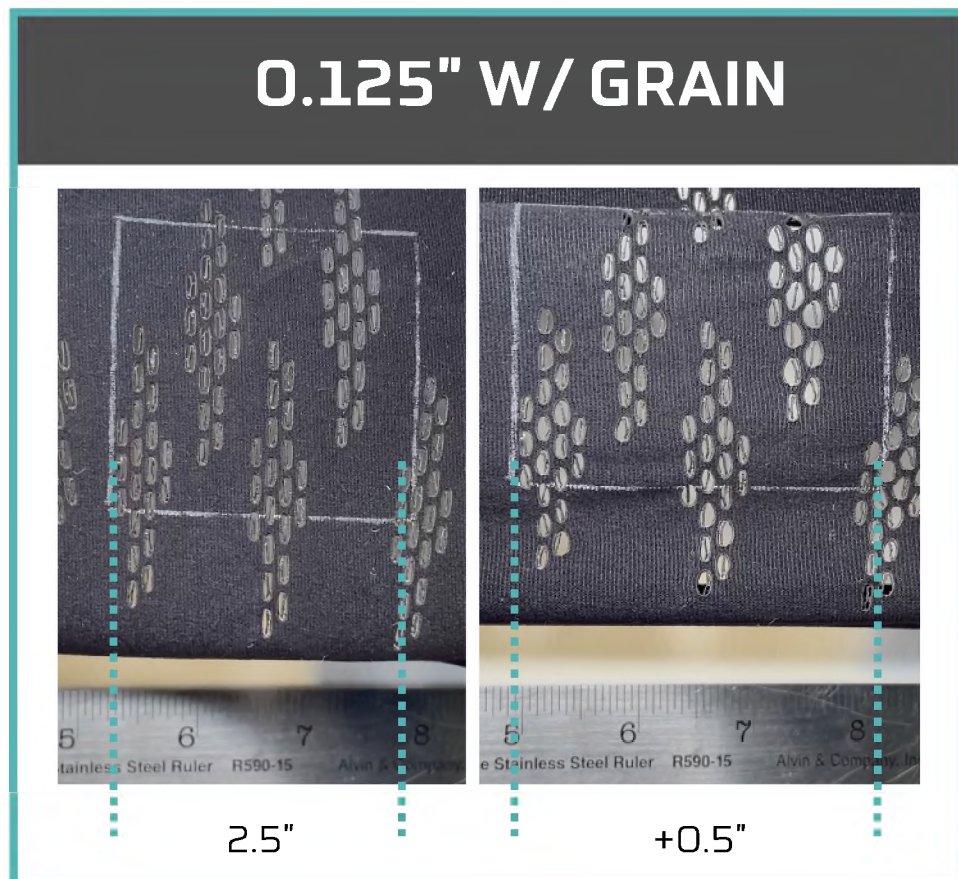
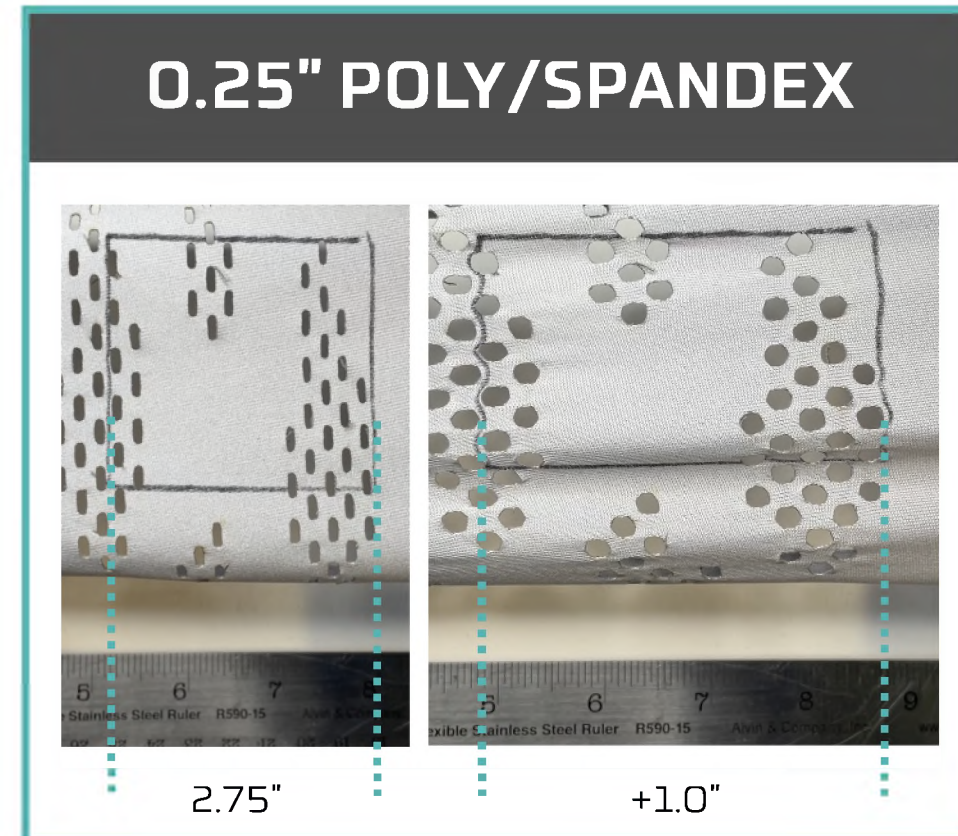
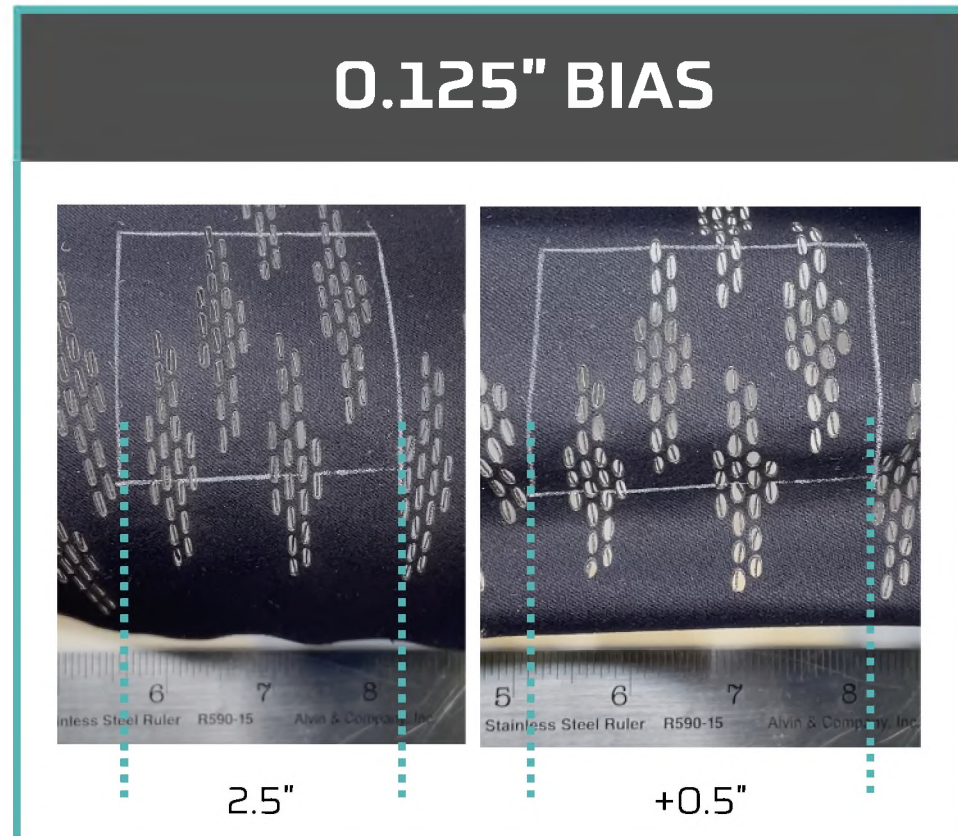

BREATHABILITY TESTING

* Focus was to determine pattern of durability would not affect breathability

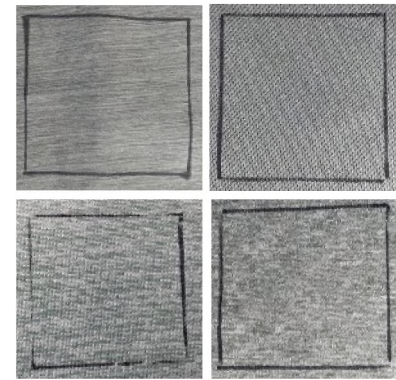

Baseline products do not allow for direct air flow to the skin.

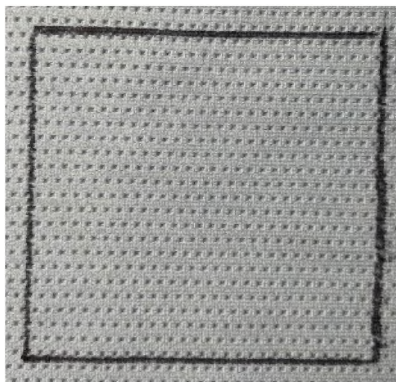

Polyester knit with no air flow to skin perforations or NERVURE technology.

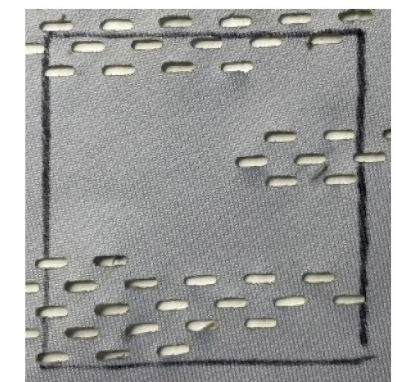

Polyester/Spandex knit blend with 0.25" perforations in a staggered pattern allows for more direct air flow to the skin.



Polyester knit with NERVURE technology and 0.25" perforations in a staggered pattern within vein gaps will allow for more direct air flow to the skin.

POLY BLEND KNIT MESH - FOOTWEAR

Without material innovation

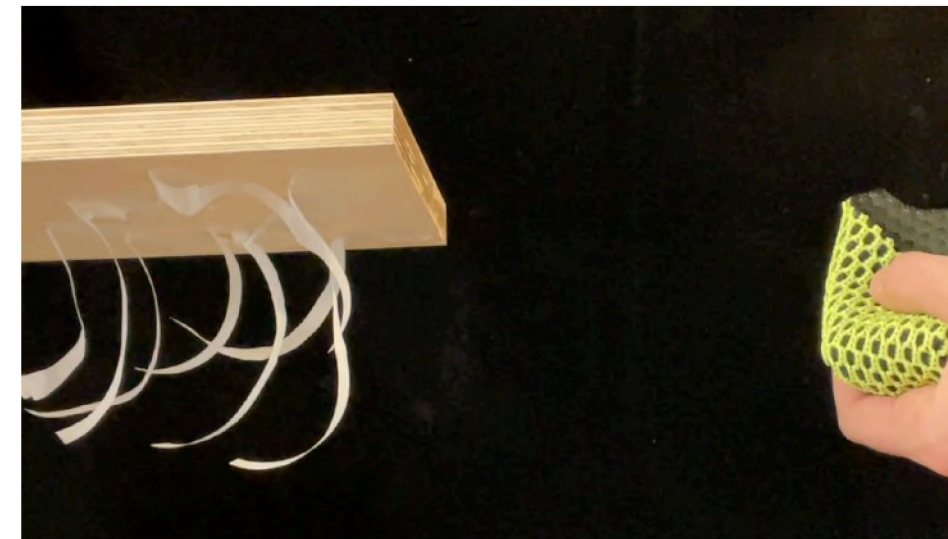

With material innovation

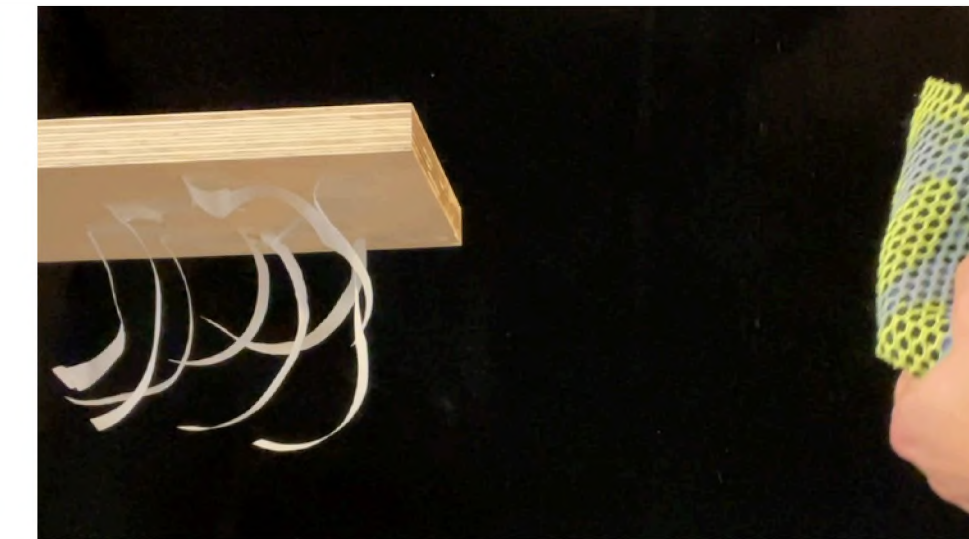

POLY KNIT - APPAREL

Without material innovation

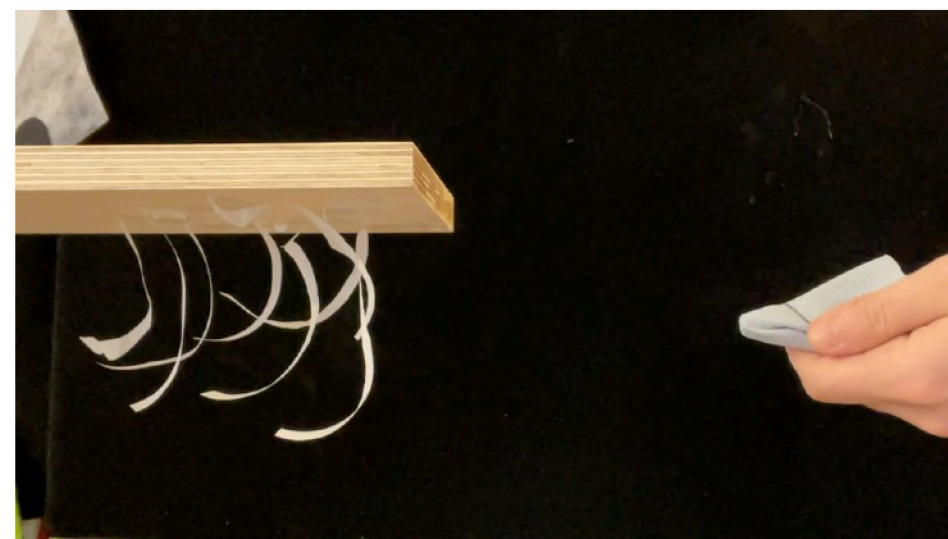

With material innovation

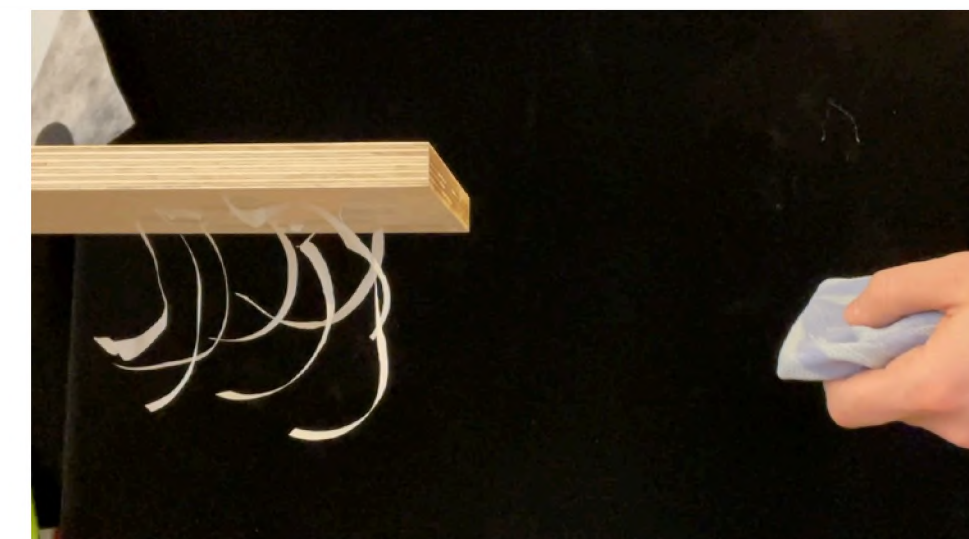

APPAREL TESTING



FIT
SEAM LOCATIONS

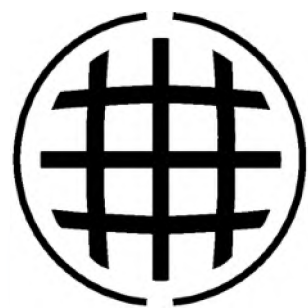

MOBILITY
MATERIAL CUT AWAYS

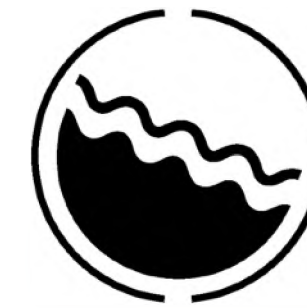

DURABILITY
TEXTILE FOCUSED

FOOTWEAR TESTING



FIT
ZONED LOCKDOWN

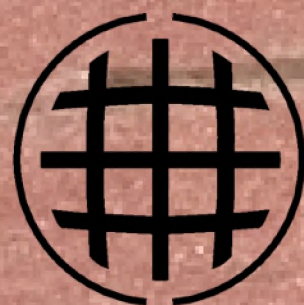

MOBILITY
UNDERFOOT FLEXIBILITY

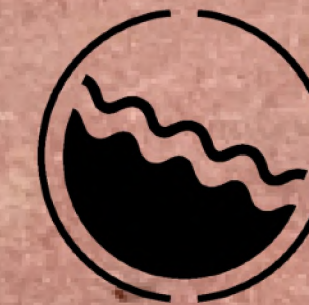

DURABILITY
TEXTILE FOCUSED

APPAREL

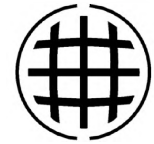

FLEXIBILITY

CUT AWAYS AT ANTERIOR ARM TO ALLOW FOR OVERHEAD/FORWARD MOBILITY

THERMOREGULATION

BACK AND UNDER-ARM PERFORATIONS FOR DIRECT AIR FLOW TO THE SKIN



DURABILITY TECH (ARM)

SEPARATED TO ALLOW FOR JOINT FLEXIBILITY

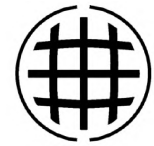

FLEXIBILITY

CUT AWAYS AT HIP TO ALLOW FOR HIP/LEG MOBILITY



FIT

ELASTIC WAISTBAND ON EXTERIOR FOR COMFORT

THERMOREGULATION

MOISTURE-WICKING KNIT FOR COMFORT AND BREATHABILITY



FIT

SEAM LOCATIONS AND PATTERNS DESIGNED AROUND BODY AND MOTION



FLEXIBILITY

3" CUT AWAYS AT ANTERIOR QUAD TO ALLOW FOR HIP/LEG MOBILITY



DURABILITY TECH

SEPARATED TO ALLOW FOR JOINT FLEXIBILITY

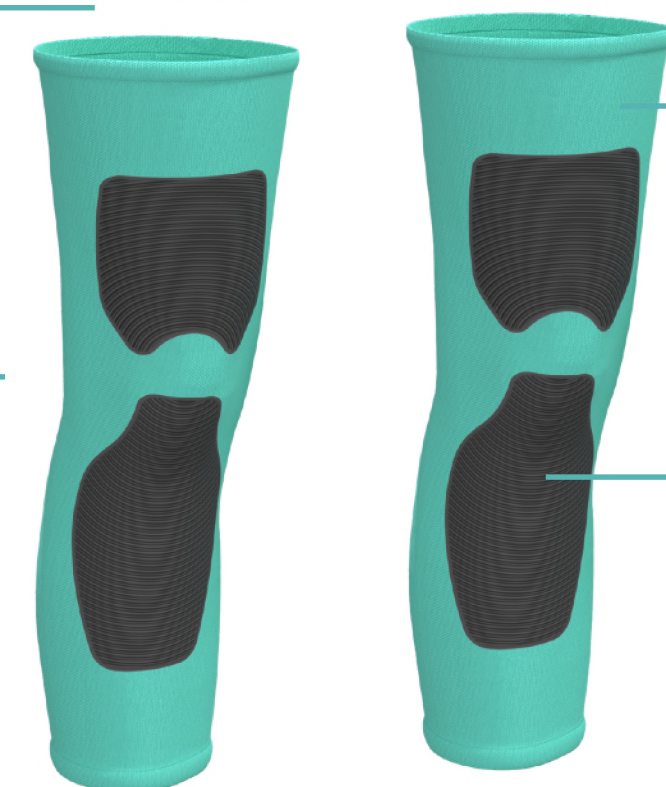

100% POLYESTER KNIT

EXO 3900 BEMIS

100% POLYESTER KNIT

DURABILITY TECH

100% POLYESTER KNIT

TECH PATCH / 100% NYLON THREAD

2" ELASTIC WAISTBAND

100% POLYESTER KNIT

100% NYLON THREAD

EXO 3900 BEMIS

100% POLYESTER KNIT

DURABILITY TECH

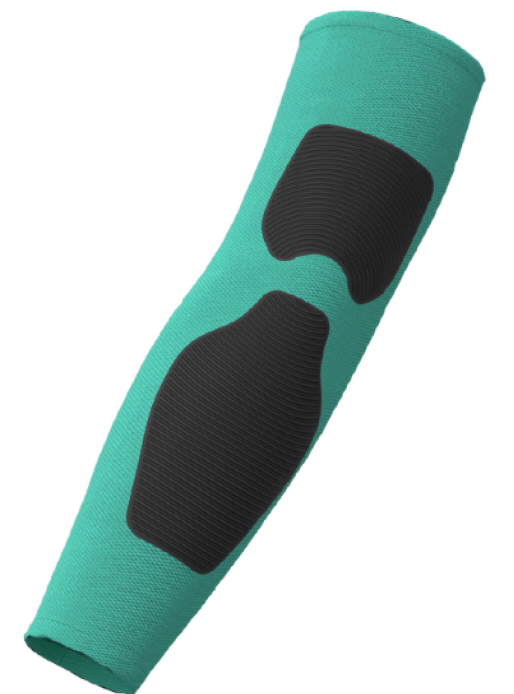

APPAREL TECH PACK

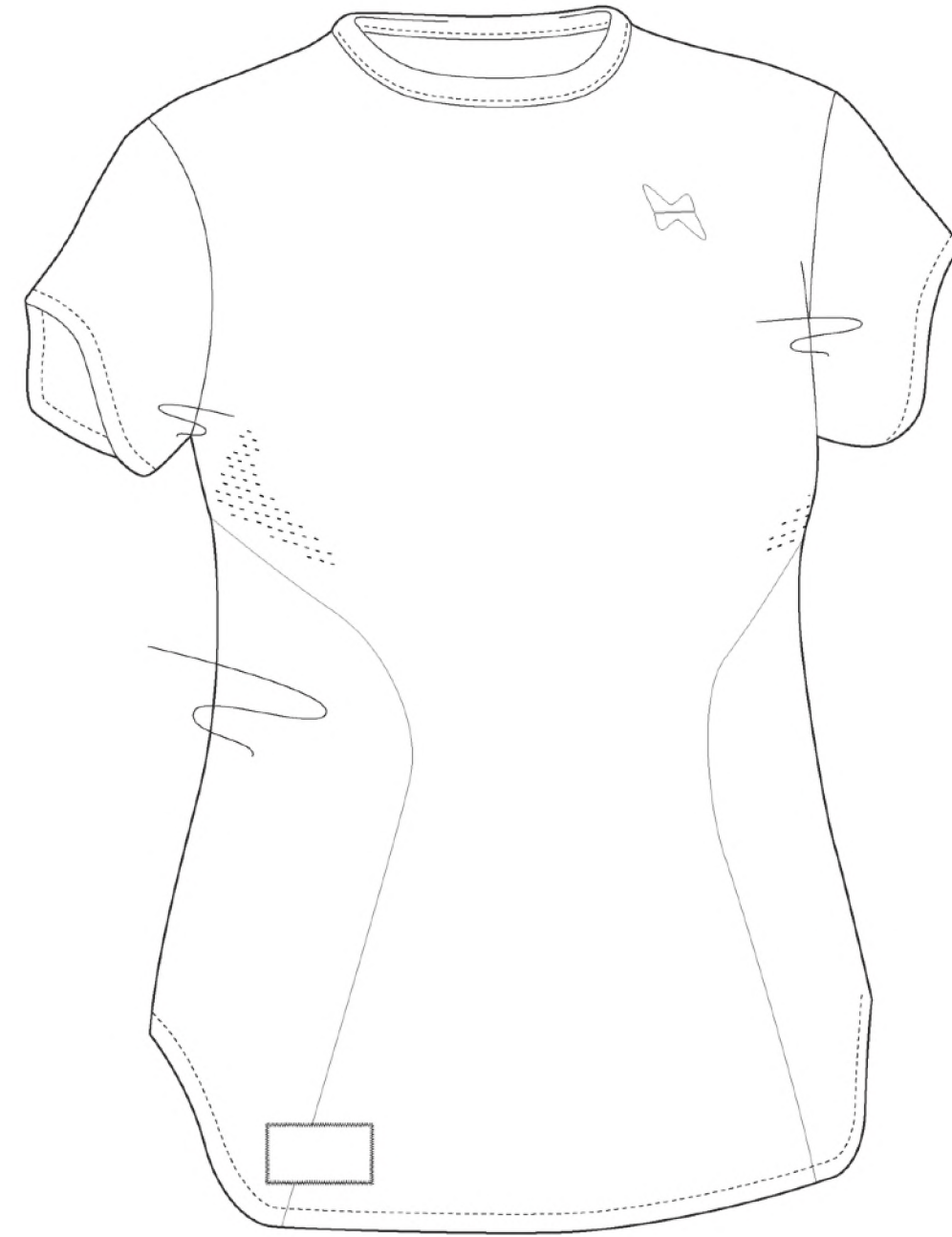

FRONT

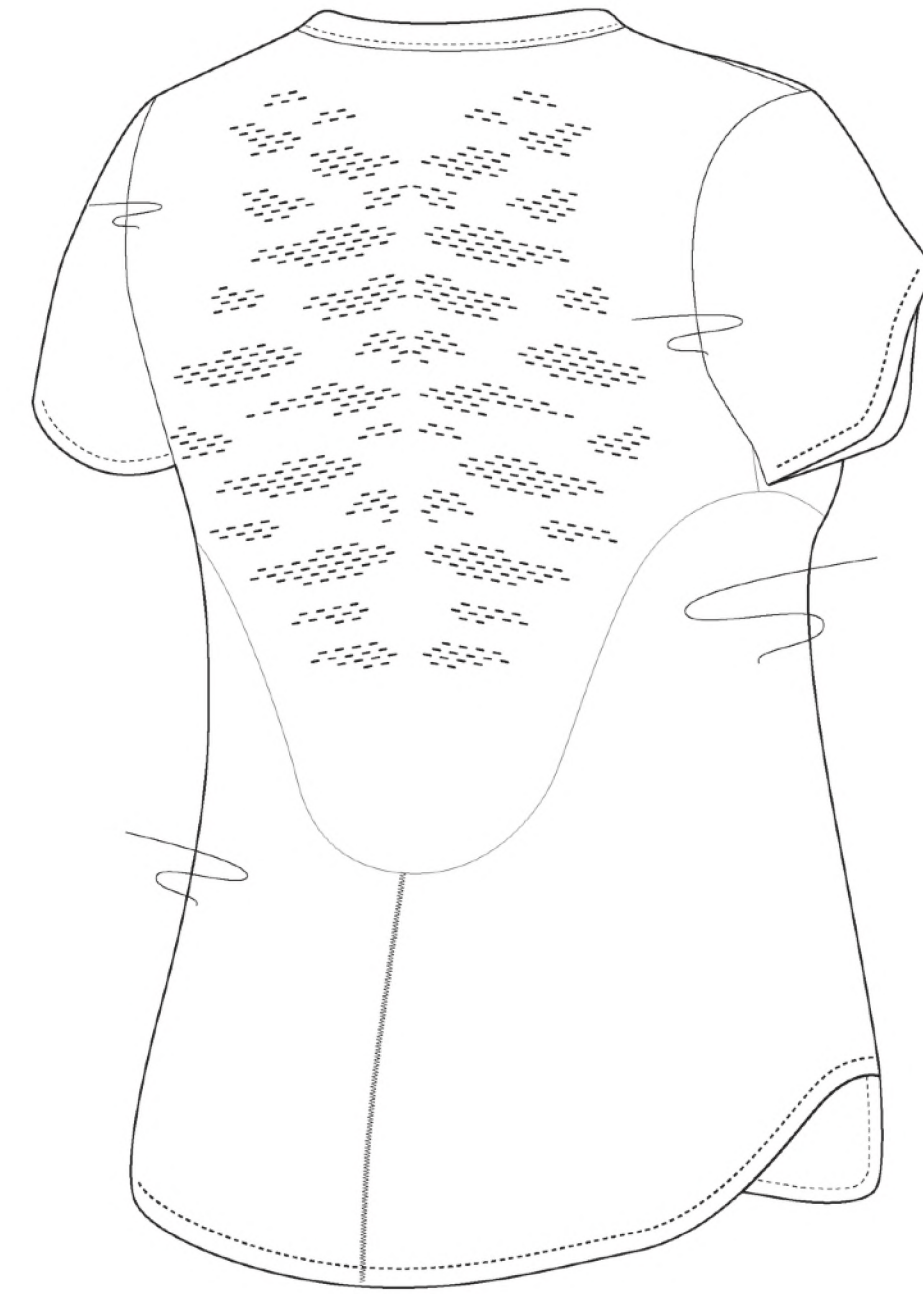

BACK

APPAREL TECH PACK



FRONT



BACK

APPAREL TECH PACK

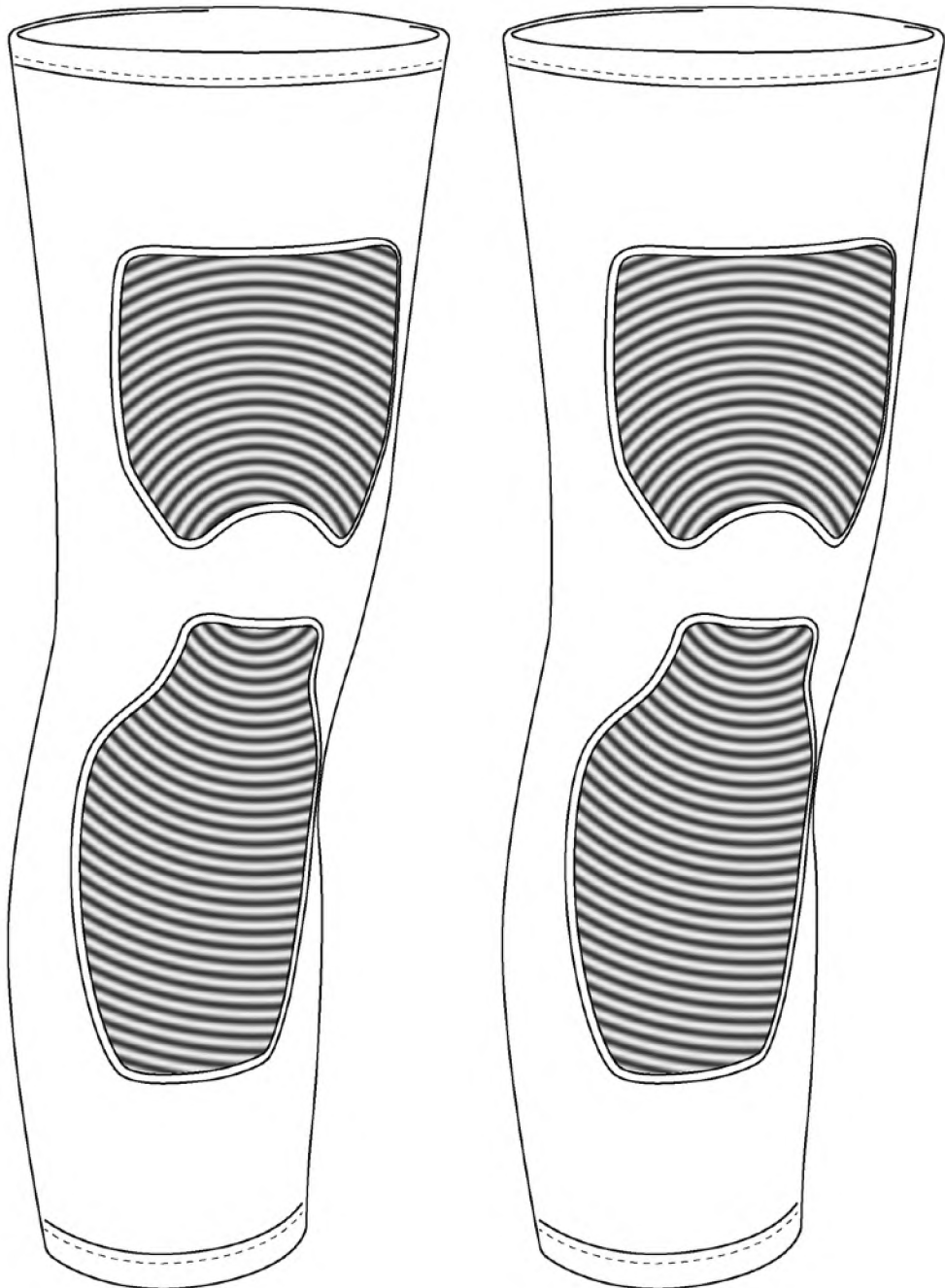

LEG SLEEVES

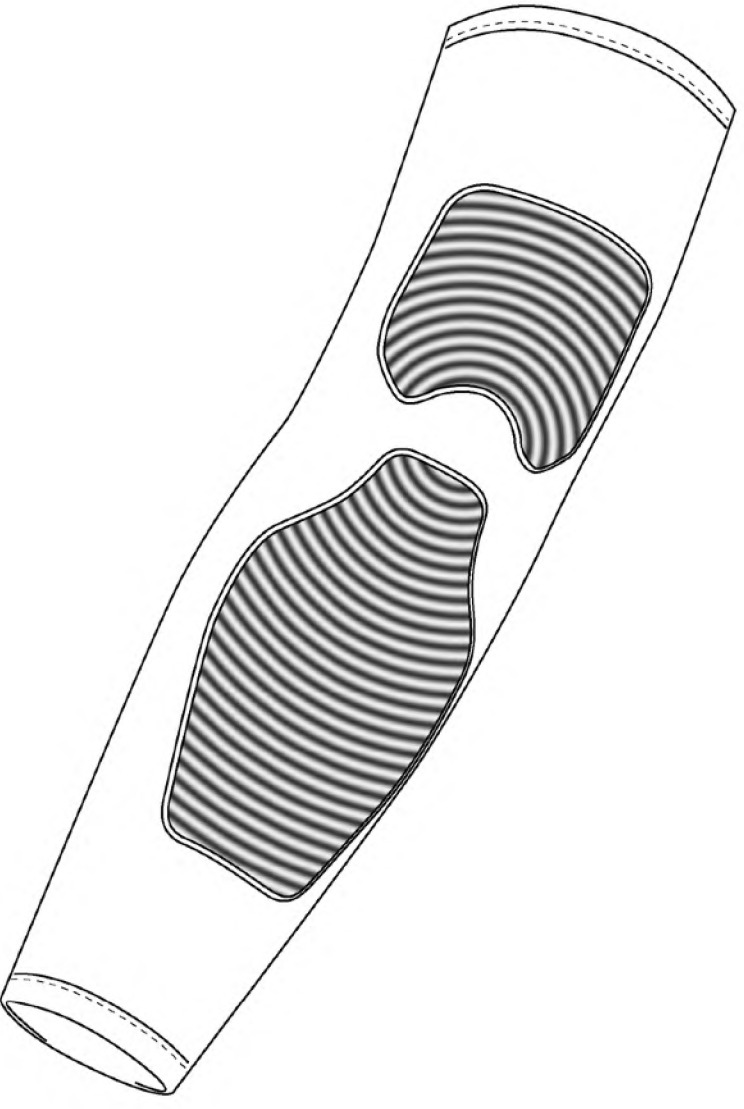

ARM SLEEVE

FOOTWEAR

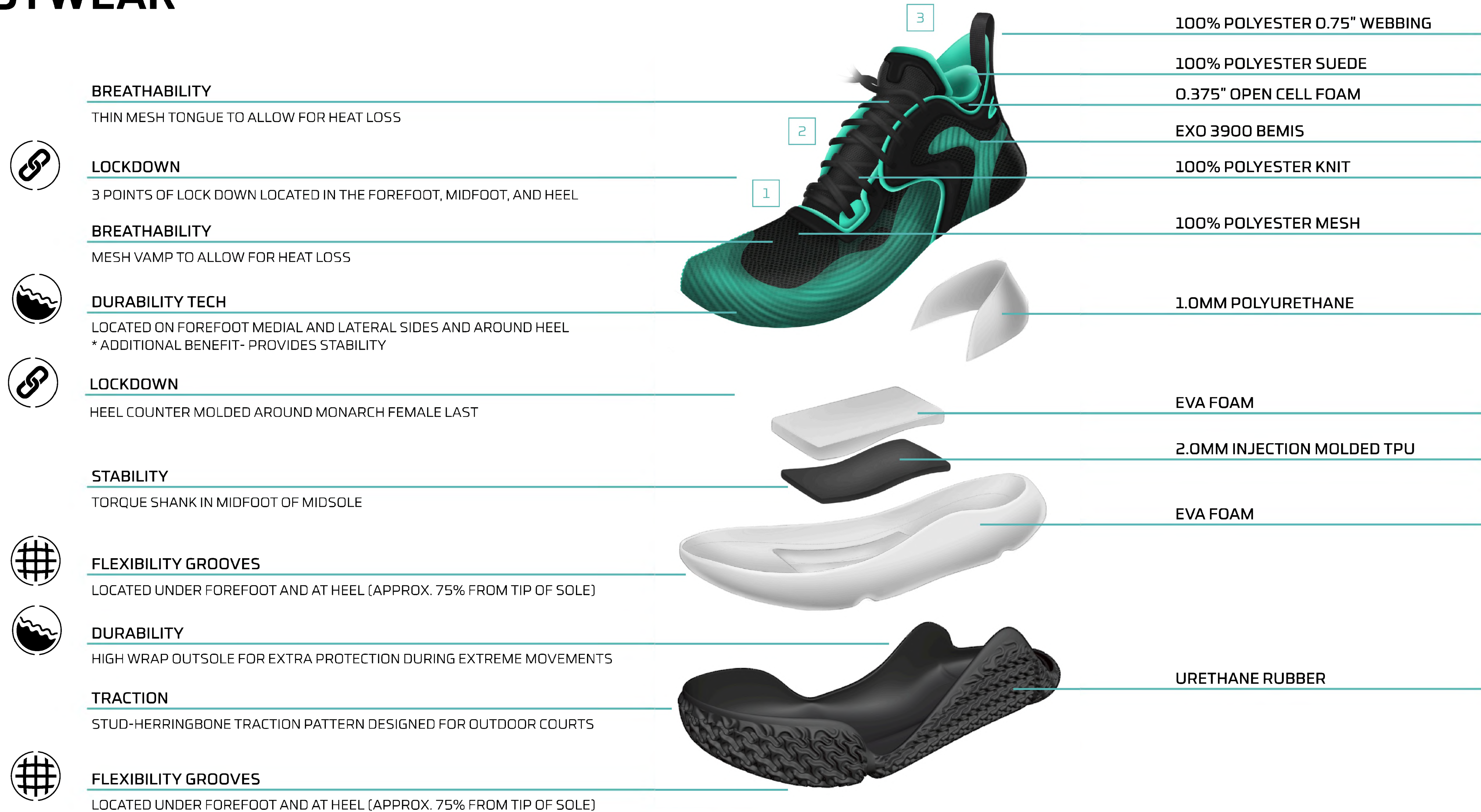

FOOTWEAR TECH PACK



LATERAL

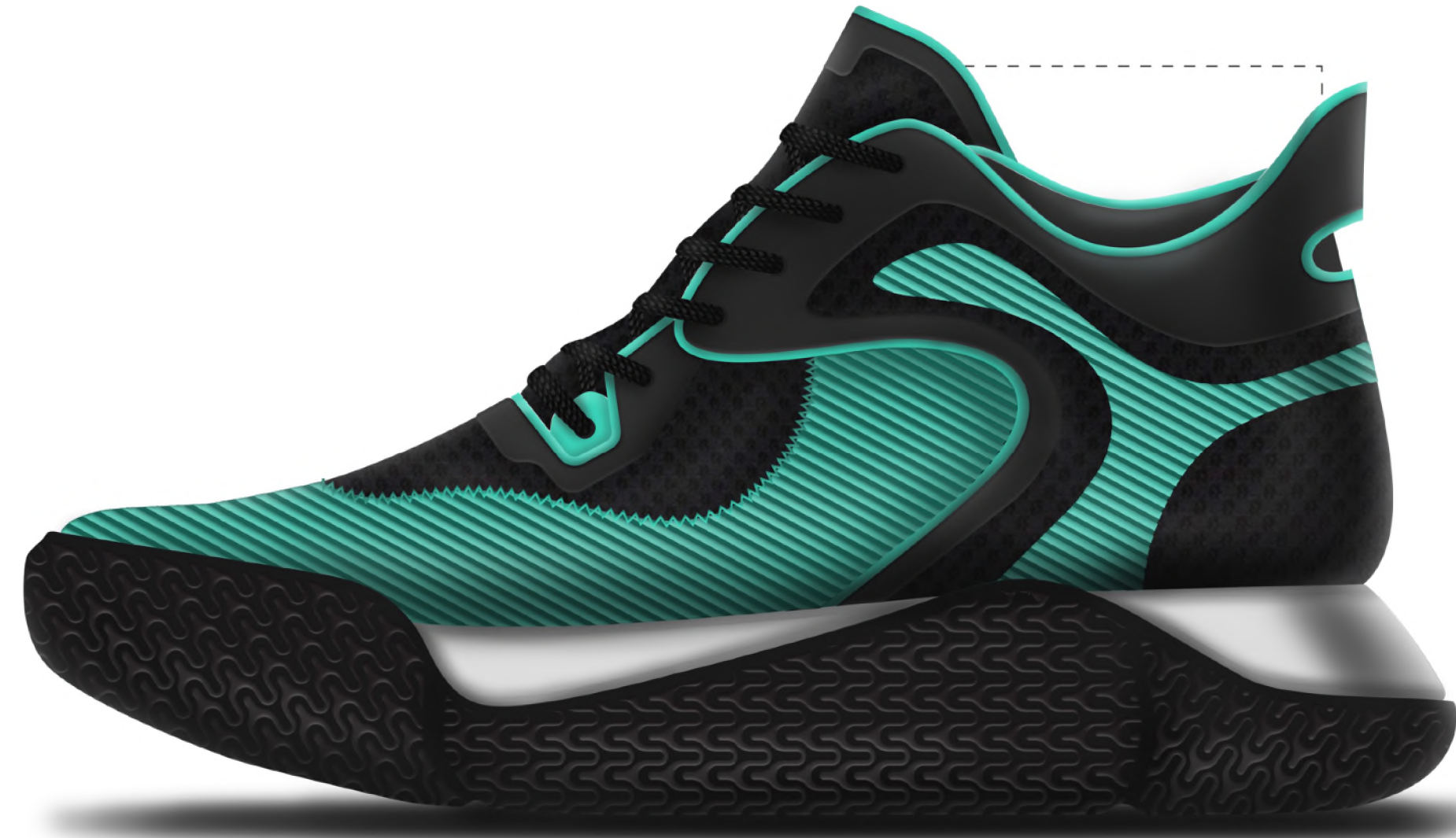

MEDIAL



FOOTWEAR TECH PACK

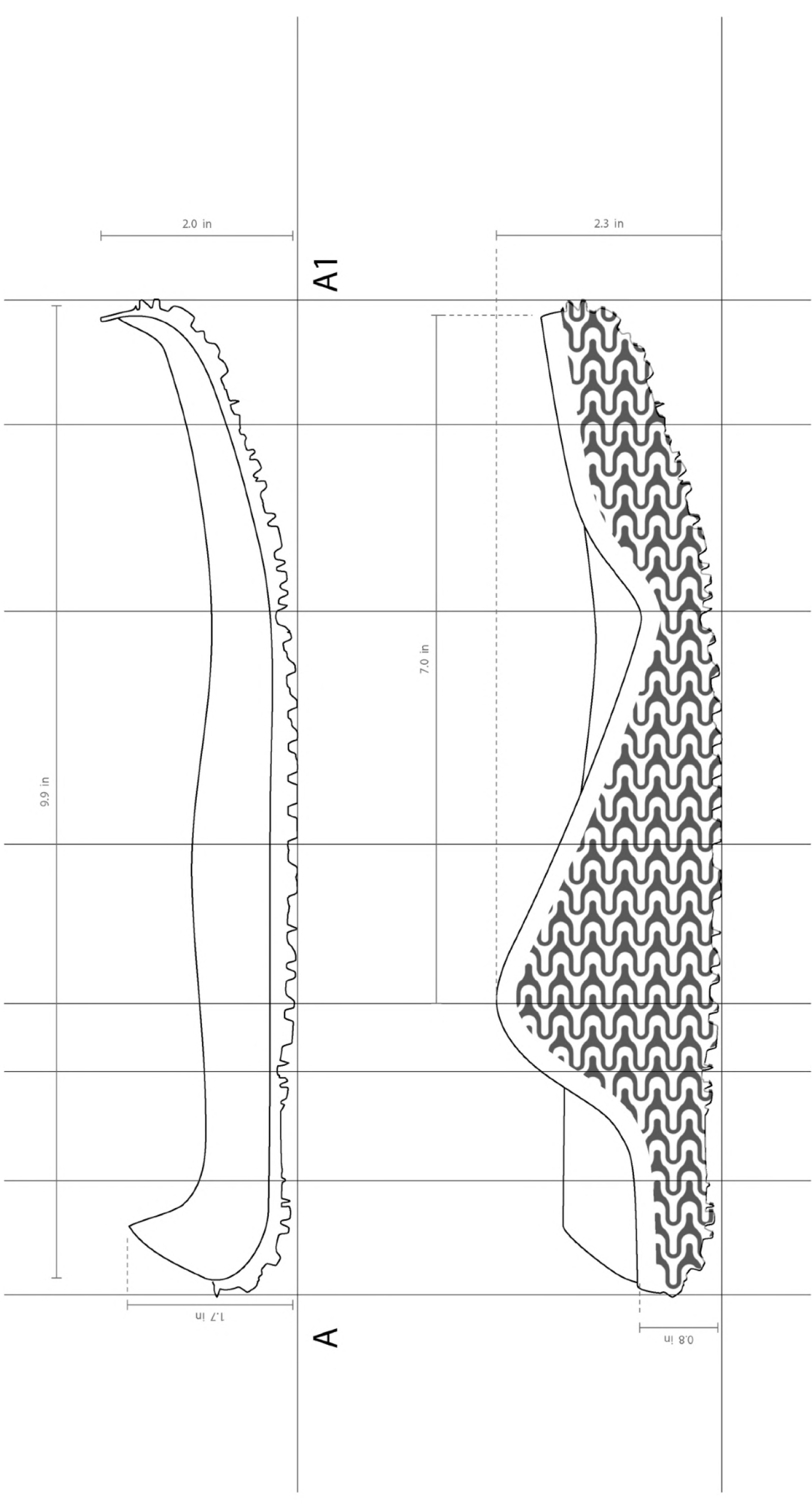

FOOTWEAR TECH PACK

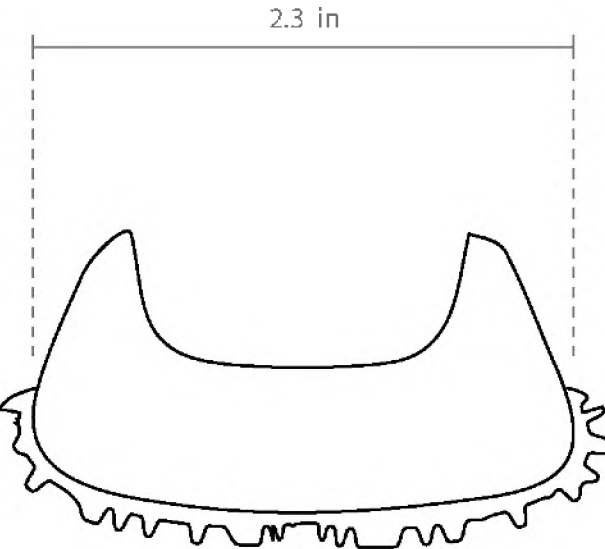

B

B1

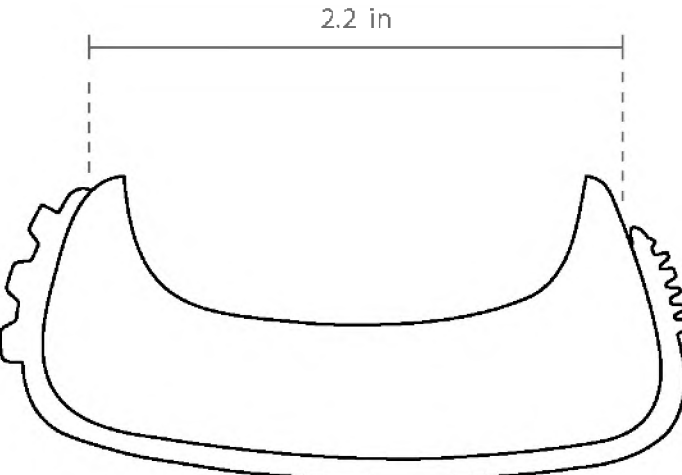

C

C1

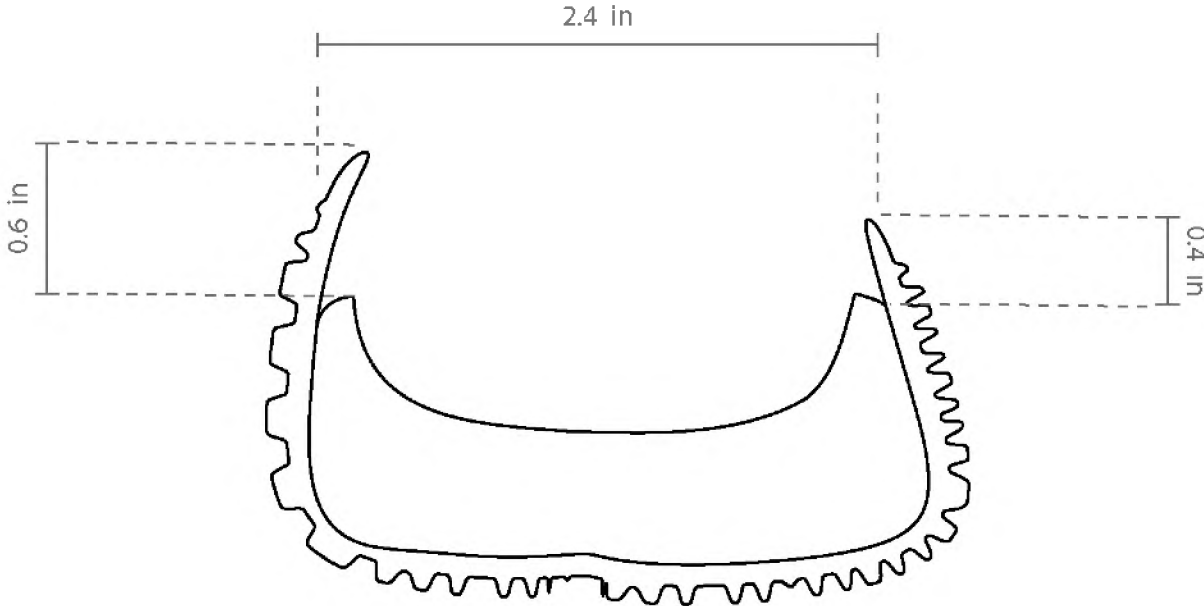

D

D1

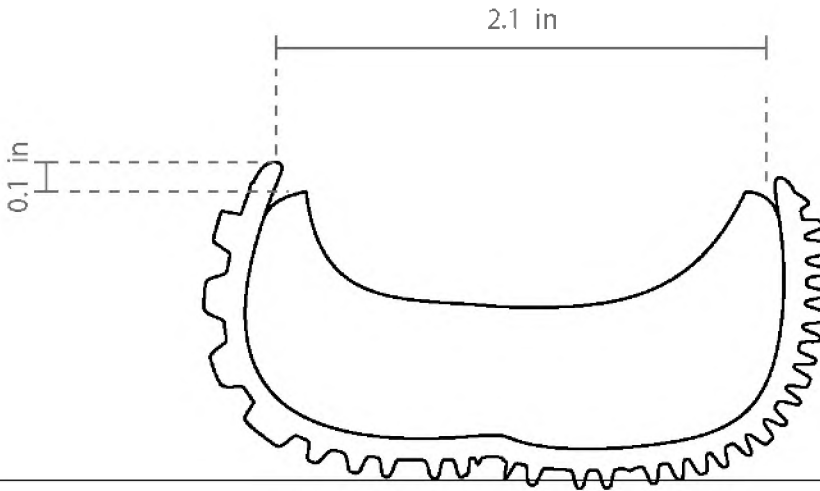

E

E1

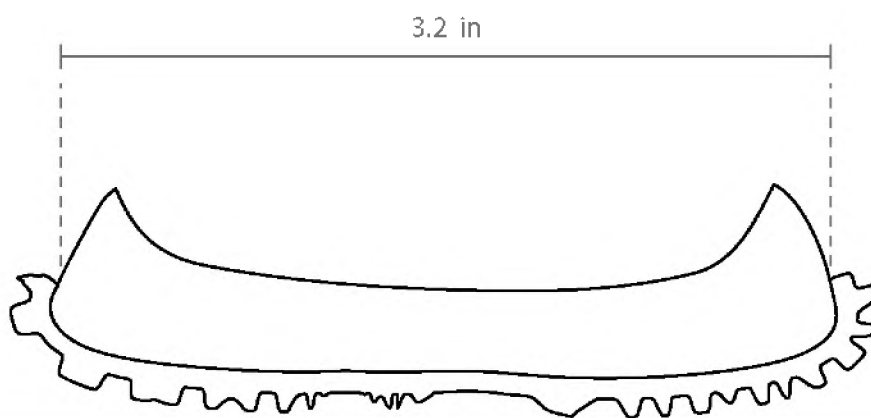

F

F1

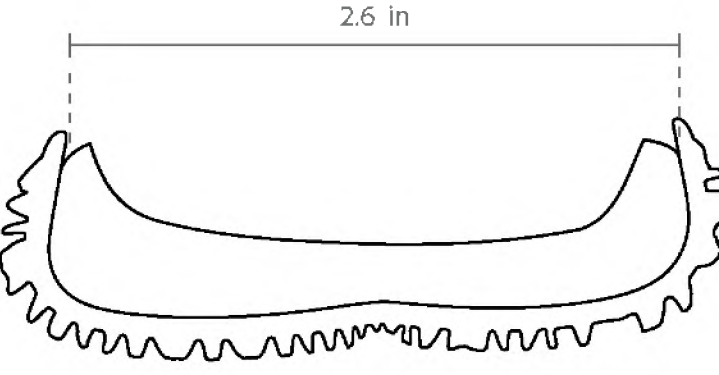

G

G1

FOOTWEAR TECH PACK

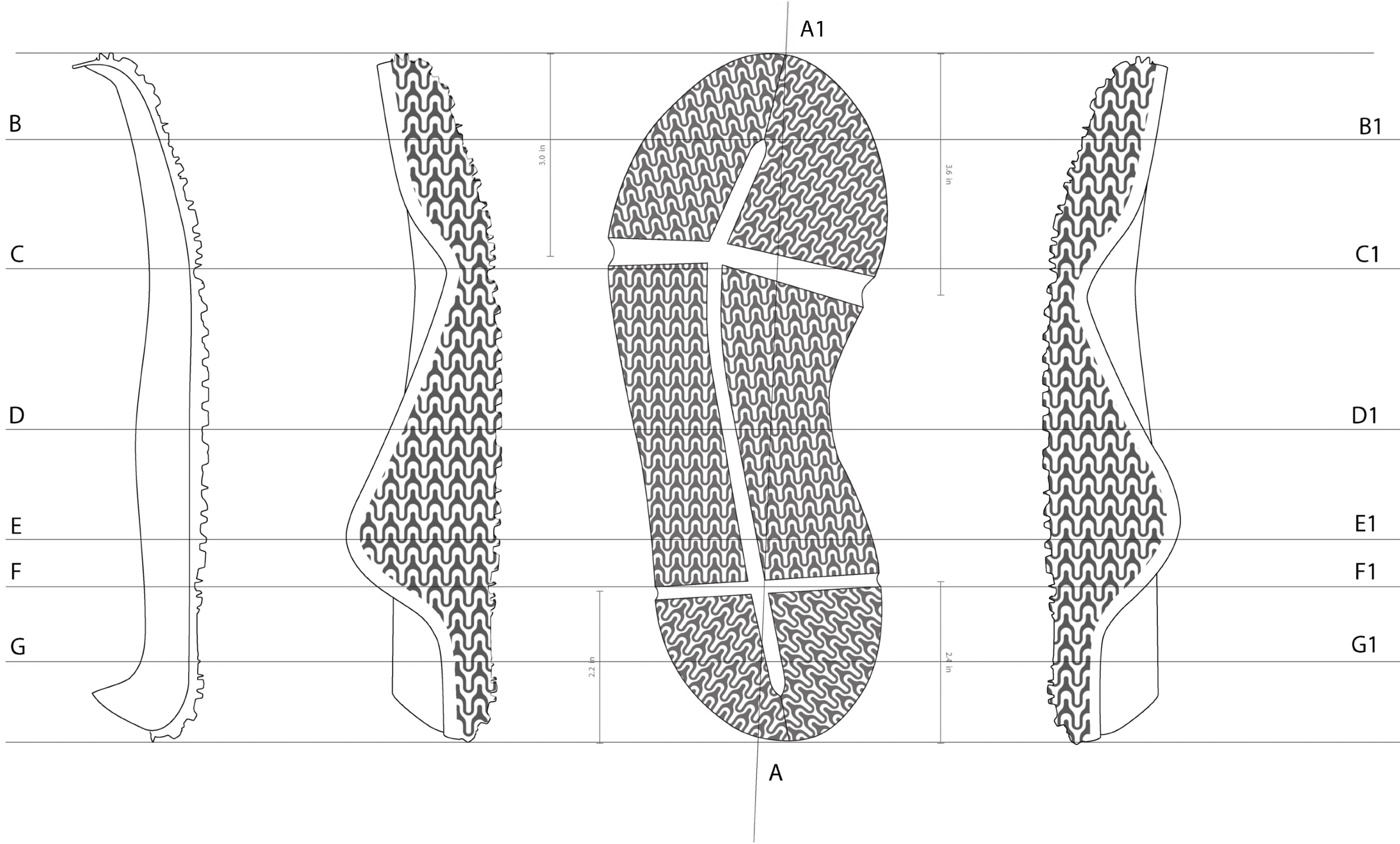

















PACKAGING



FINAL RENDER



COLORWAYS

PANTONE NEUTRAL BLACK C

PANTONE 877 C

PANTONE 427 C

PANTONE 7472 C

PANTONE 3245 C



VALIDATION

EMILY CARNEY

DIRECTOR MATERIAL DEVELOPMENT
FOOTWEAR

DAVID LITTON

SR. MATERIALS DEVELOPMENT
FOOTWEAR

Experimentation with different materials and integration into textile is really interesting and exciting. The last development has a lot of overlap with new women's lasts being developed and could be a great tool for the future of women's basketball specific footwear especially since these athletes can vary more in height.



KINAKO

WOMEN'S OUTDOOR
BASKETBALL ATHLETE

Loving the aesthetic and function you added. I think the lockdown features would be really helpful and the teal portions would definitely protect my shoes. The shoes look like they'd hug my ankle to provide support in addition to lockdown.

The apparel looks strong with the bright teal. I really like the cut away features in the apparel. The sleeves I wear always end up sliding down and ripping above and below the knee area so I really like the separated protective pads for both durability and flexibility.





FIT

5%

BUILD FEMALE-SPECIFIC LAST TO CREATE 3 POINTS OF LOCKDOWN TO AVOID SLIPPAGE WITHIN THE SHOE. SEAM PLACEMENT TO FOLLOW WOMEN'S OUTDOOR BASKETBALL MOVEMENTS.

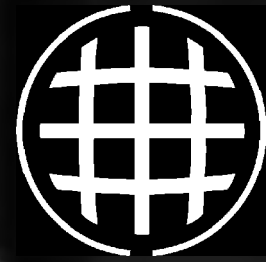

MOBILITY

5%

ADD FLEXIBILITY ZONES TO THE FOREFOOT AND HEEL AREAS OF THE OUTSOLE. TAKE AWAY MATERIAL AT JOINT LOCATIONS WHERE THERE IS A HIGH RANGE OF MOTION.

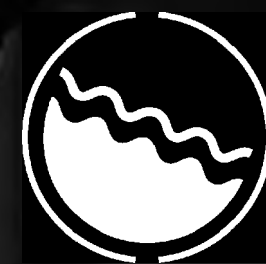

DURABILITY

10%

PILLING AND FIBER SHEDDING OCCURS AFTER 35 SECONDS. PROTECT AGAINST LONG TERM WEAR SO THE ATHLETE KEEPS THE PRODUCT LONGER.

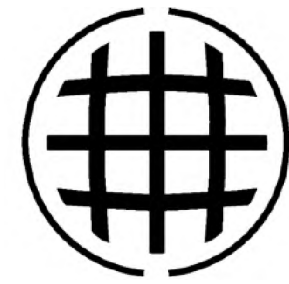

MONARCH ADDRESSES THE NEEDS FOR DURABILITY, MOBILITY, AND FEMALE-SPECIFIC FIT IN THE SPONTANEOUS AND FLUCTUATING ENVIRONMENTS OF OUTDOOR BASKETBALL.





MONARCH

**THANK
YOU**