

Radiation Hardness of CCDs

Nick Sinev, University of Oregon

Plan:

- Overview of Silicon Technologies
- Difference in silicon specifications for microstrip and CCD detectors
- Effects of radiation on silicon detectors
- Details of bulk silicon radiation damage
- Overview of known measurements of radiation damage of CCDs
- VXD3 experience
- Experiment on spare VXD3 CCD
- Methods to increase radiation tolerance of CCD based detector
- Plan for more measurements

Silicon production: commercial and particle detectors material - 1

- Commercial Silicon- dominant method of crystal growing is the Czochralski method.

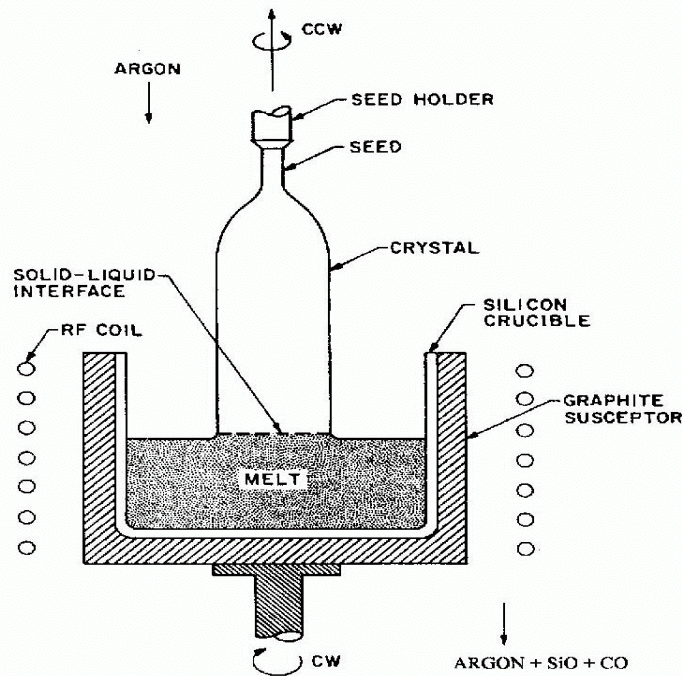

High oxygen concentration – not harmful and may be even advantageous.

Difficult to achieve purity level needed for high resistance silicon
Modifications of the method – magnetic field applied and continuous growth

Silicon production: commercial and particle detectors material - 2

CHAPTER 2. SILICO

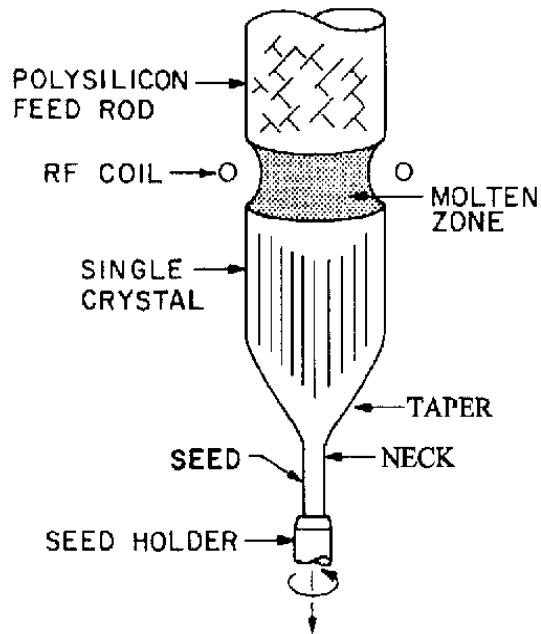

- Float zone silicon – allows much better control on impurity concentration. But electronic industry does not need so pure silicon. So it's very hard to find on the market. It is also difficult to achieve high homogeneity of dopant distribution in FZ method

Silicon production: commercial and particle detectors material - 3

- Neutron transmutation .

B is more uniformly distributed in Si crystal because it's "equilibrium segregation coefficient" closer to 1 (0.8), than for P (0.35). Thus, production of n-type Si with good uniformity of dopants is difficult. But Neutron transmutation method allows conversion of up to 3.1% of the Si into P by the mean of reaction:



This is one of the method of producing high quality n-type Si.

Silicon production: commercial and particle detectors material - 4

- Epitaxial silicon. The method of the epitaxial growth of the controlled purity silicon on the low-resistance substrate of Czochralski silicon is widely used in electronic industry, and in the production of CCDs. However, it is generally not suitable for production of microstrip detectors- difficulty to grow thick enough layer of epitaxial silicon, and to get rid of substrate.

Difference between microstrip and CCD silicon requirements

- Microstrip detectors – high resistivity needed to fully deplete entire detector thickness (300 μ typical). High “minority carriers lifetime” correlates to low leakage current – also important parameter to keep noise level down.
- CCD detectors – no need in high resistivity, depletion length is only few μ . Leakage current generally is not the problem, because CCDs usually operate at cryogenic temperature (no way they can operate at room temperature).

Difference between microstrip and CCD operation

Microstrip detector



CCD

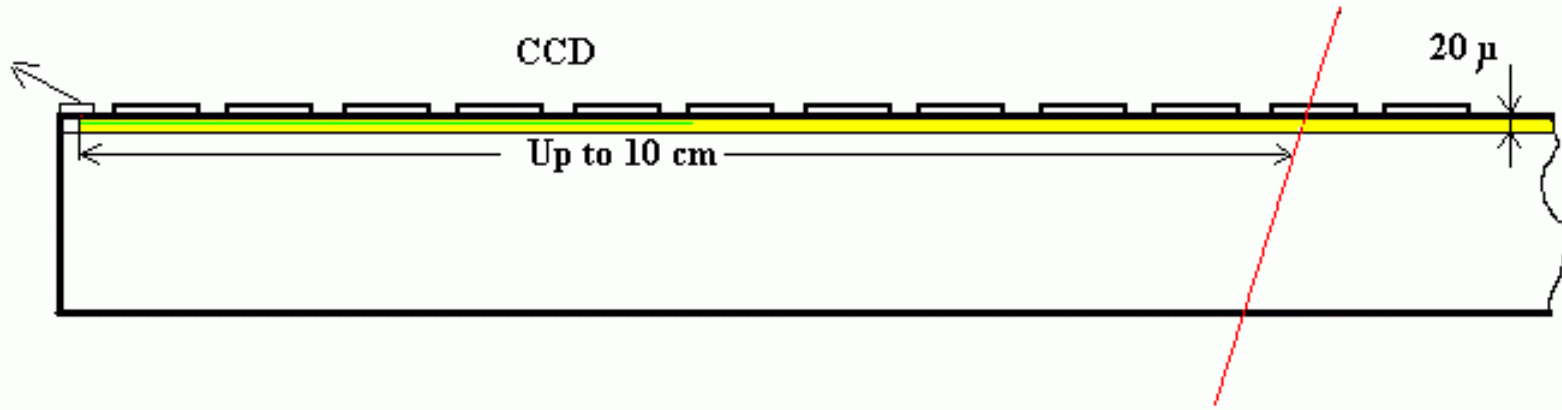

Effect of radiation damage in the silicon detectors

- Accumulation of the charge in the silicon oxide – lead to changes of the electrical field in the detector – can be compensated by voltage adjustment and can be reduced by keeping voltage off during high dose irradiation. Noticeable effect at exposure to ionizing particles at the dose level of hundreds Krads. Can be reduced by using special “radiation hard” insulators and minimizing the thickness of insulator. Should be kept in the mind, however can be dealt with.
- Increased dark current. Is not an issue if detector operates at cryogenic temperature.
- Generation of charge traps by displacement damage of bulk silicon. This is our main concern. Let’s look at it in more details.

Details of bulk silicon radiation damage - 1

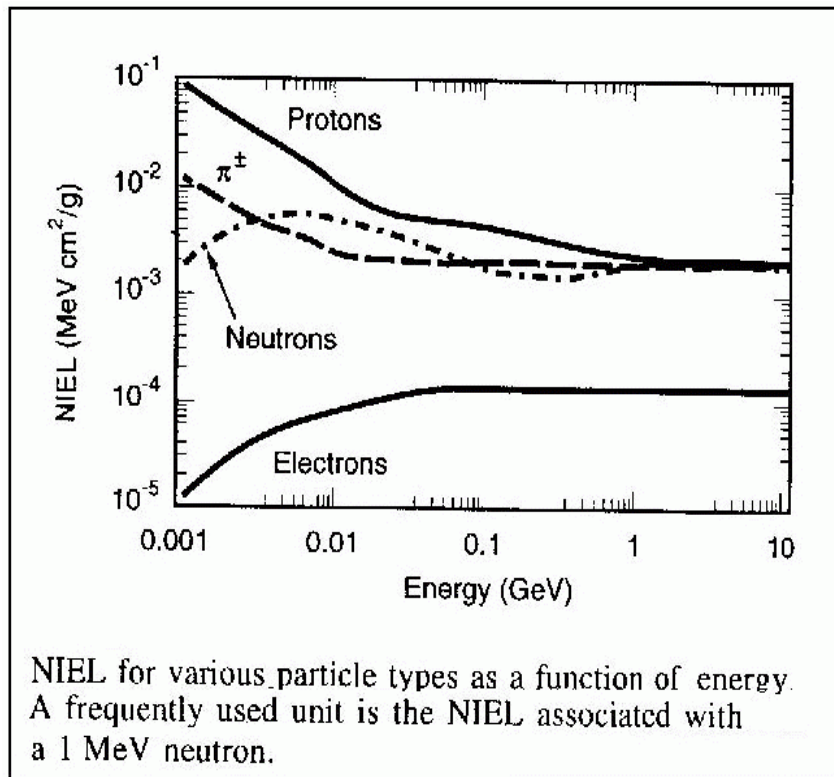

- Concept of NIEL – non-ionizing energy loss. This is energy loss due to collision with lattice nuclei. The hypothesis that rate of radiation damage scales with NIEL. NIEL strongly depends on the mass of the particle.

Details of bulk silicon radiation damage - 2

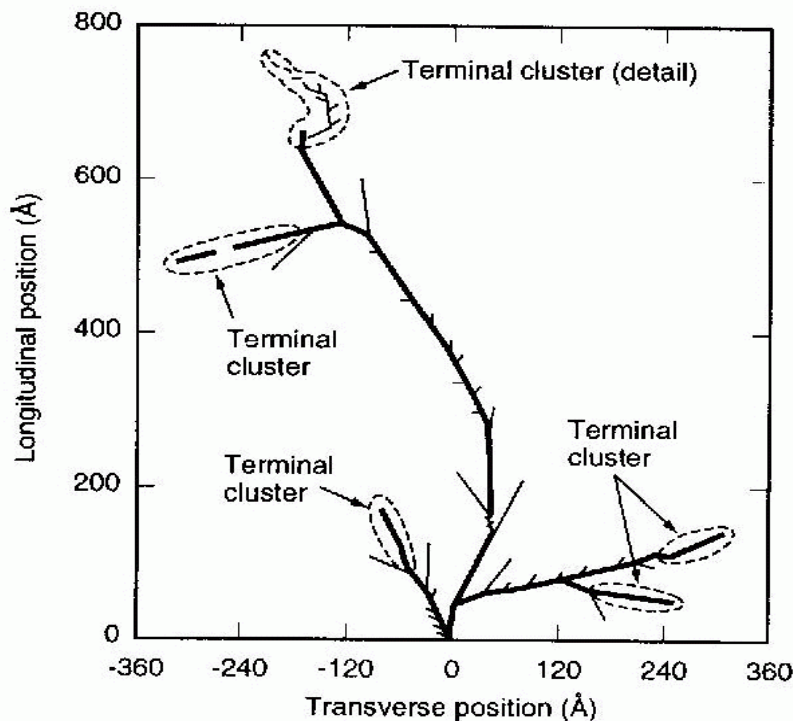

Development of cluster damage due to a primary knock-on silicon atom of 50 keV, within the bulk material.

- The characteristics of the displacement damage depend on the maximum energy transferred to knock on nucleus. The density of interstitials and vacancies generated at the terminal clusters affects further development.

Details of bulk silicon radiation damage - 3

- Drift of the vacancies (V) and interstitials (I) through silicon: (C_s – substitution carbon, C_i – interstitial carbon (mobile))

Interstitials reactions

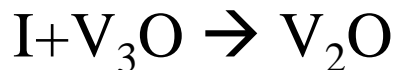

Vacancies reactions

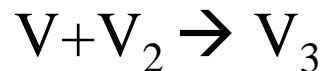
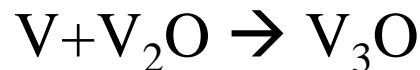
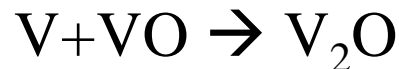
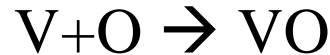

C_i reactions

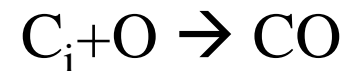
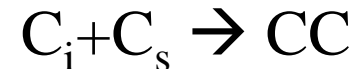

Reactions in terminal cluster:

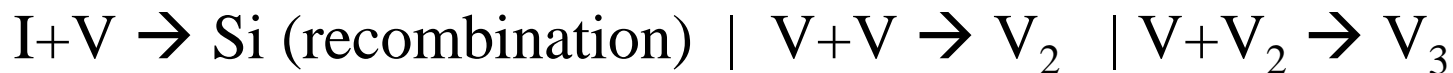

Details of bulk silicon radiation damage - 4

- Defect state and energy levels

Defect identity	Energy level	Defect type	Anneal temp
VO	$E_C - 0.17$	acceptor	350° C
V ₂ O	$E_C - 0.50$	acceptor	?
V ₂	$E_C - 0.23$	acceptor	300° C
V ₂	$E_C - 0.42$	acceptor	300° C
V ₂	$E_V + 0.25$	donor	300° C
VP	$E_C - 0.45$	acceptor	150° C
CC	$E_C - 0.17$	acceptor	?
CO	$E_V + 0.36$	donor	?

Known data on radiation damage in the CCD detectors

- There are large number of published results on radiation damage effects in silicon detectors. However the majority of these measurements are made with thick diode type detectors like one used for microstrip devices. Very few studied radiation damage in CCDs.
 - EEV type CCDs (in VXD3 we also used EEV devices) were investigated in early 90 by G.R.Hopkinson and others
 - Hamamatsu Photonics “multipinned phase” CCDs were investigated by K.D.Stefanov and others recently
 - Jim Brau and myself published our results on VXD3 CCDs radiation damage test in IEEE TNS (47:1898-1901, 2000)

What have been observed

- Charge transfer inefficiency:

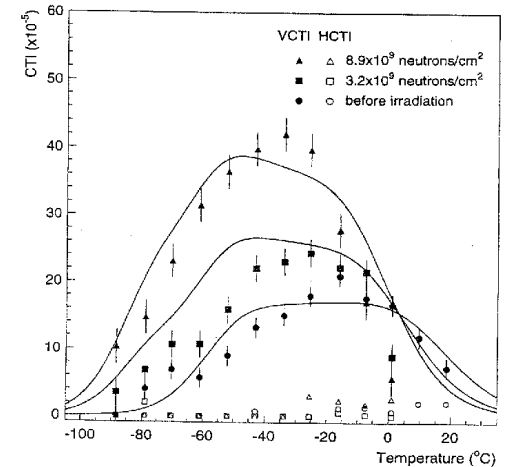
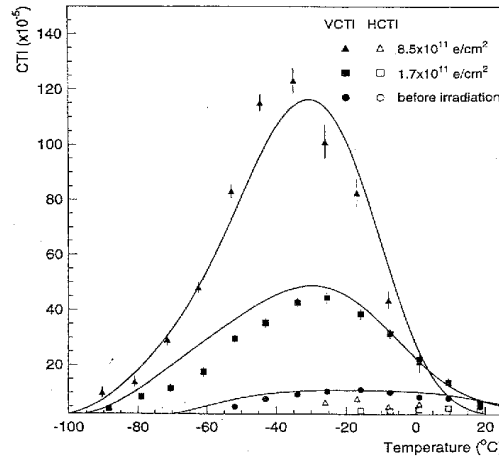
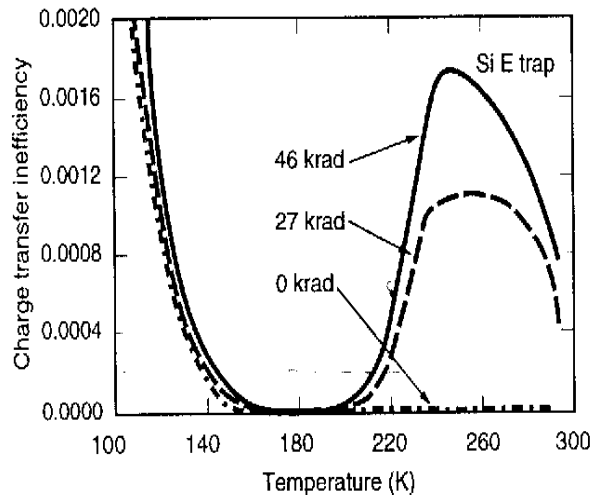

Charge transfer inefficiency as function of temperature from the early measurements of Hopkins (left) and recent of Stefanov (for electron irradiated CCDs – middle and neutron irradiated CCDs – left). Curves on Stefanov plots are calculated assuming two energy levels of defects $E_C - 0.44$ and $E_C - 0.37$

What have been observed

- Voltage shift

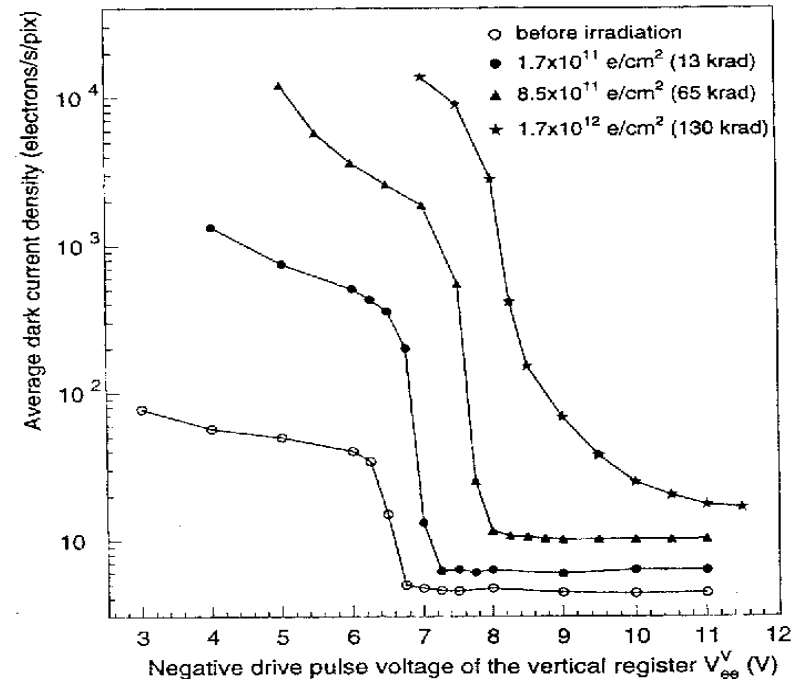
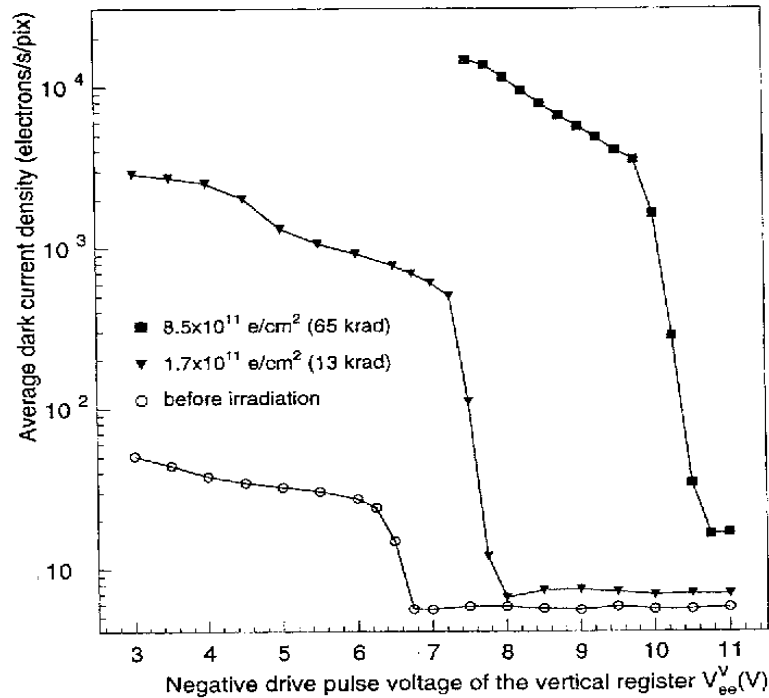

From Stefanov measurement. Left picture represent voltage shift for CCDs biased and clocked during irradiation with electrons, Right – for unbiased during irradiation CCDs.

VXD3 experience

- During VXD3 commissioning there was fire in dumping ring. During dumping ring repair we decided to continue using of undumped beam for the VXD3 hardware and software debugging. At that time we had sometime very high background levels in CCDs. Later it was found, that innermost CCDs sustained radiation damage:

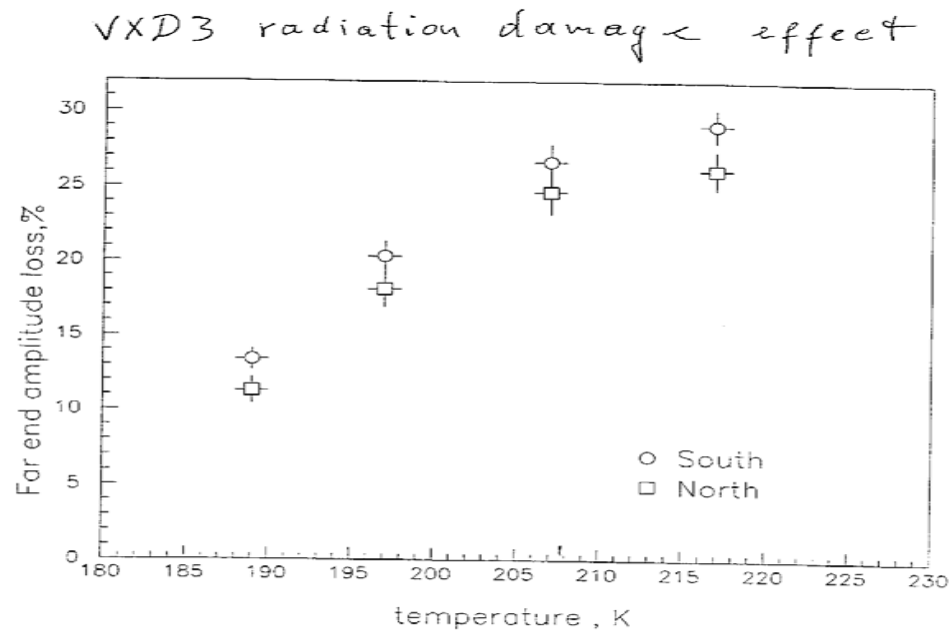

Signal loss during charge transfer from far region of the image due to radiation damage of CCDs as function of the CCD temperature

Experiment on spare VXD3 CCD

Equipment used for CCD test at SLAC

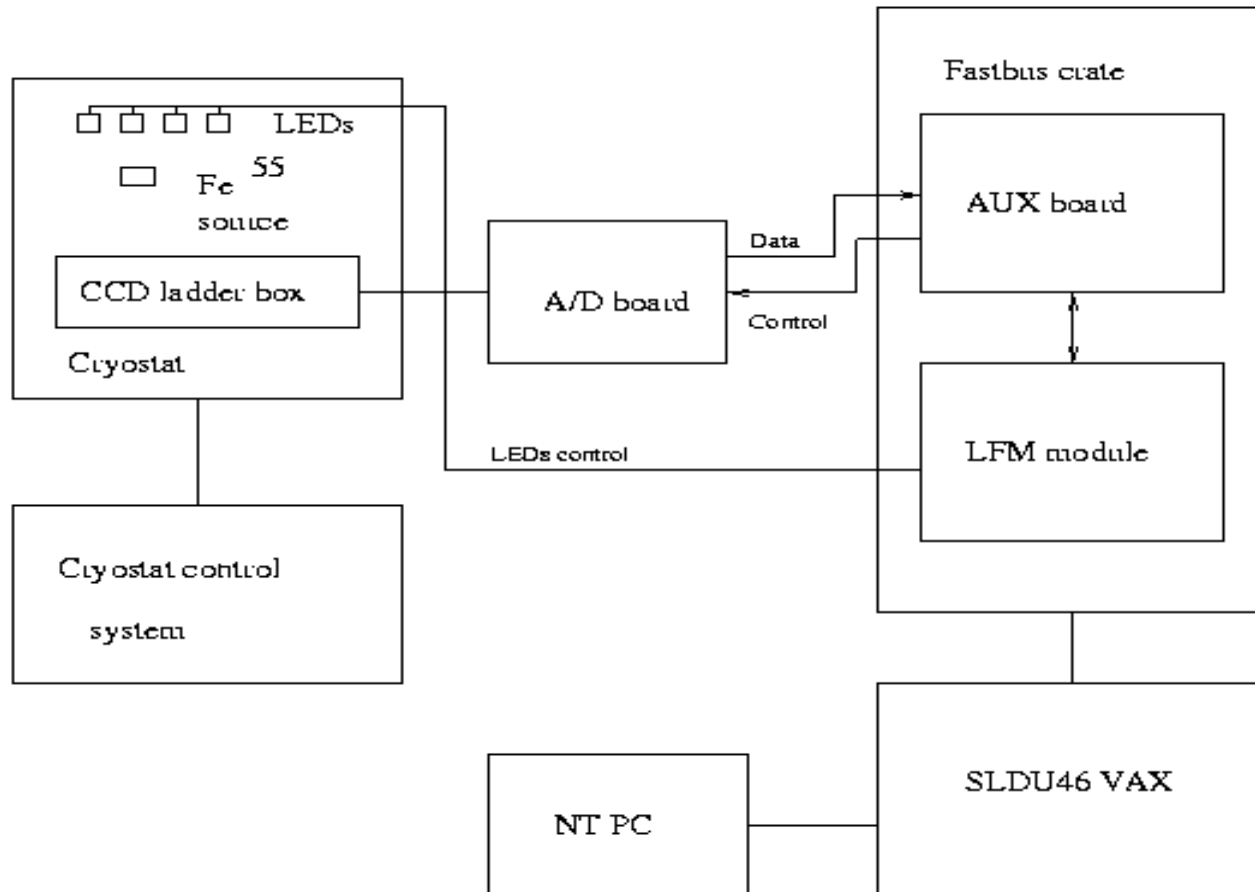

Experiment on spare VXD3 CCD

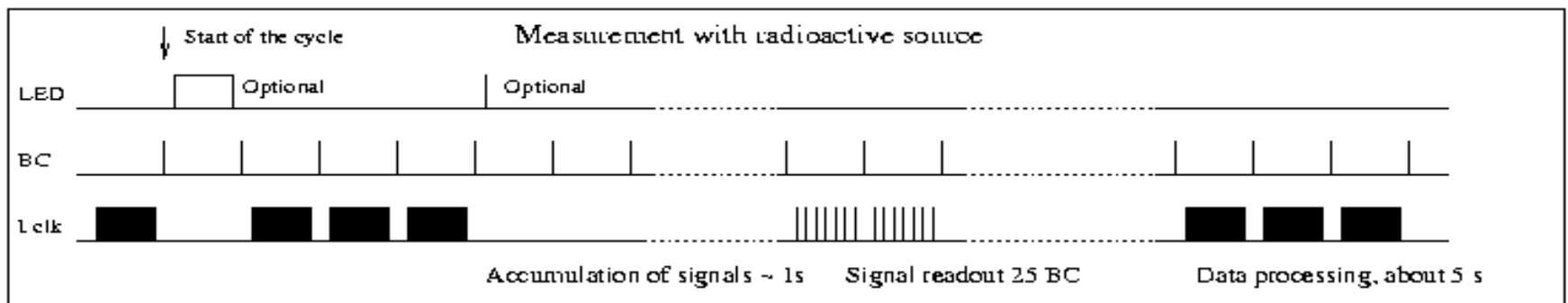
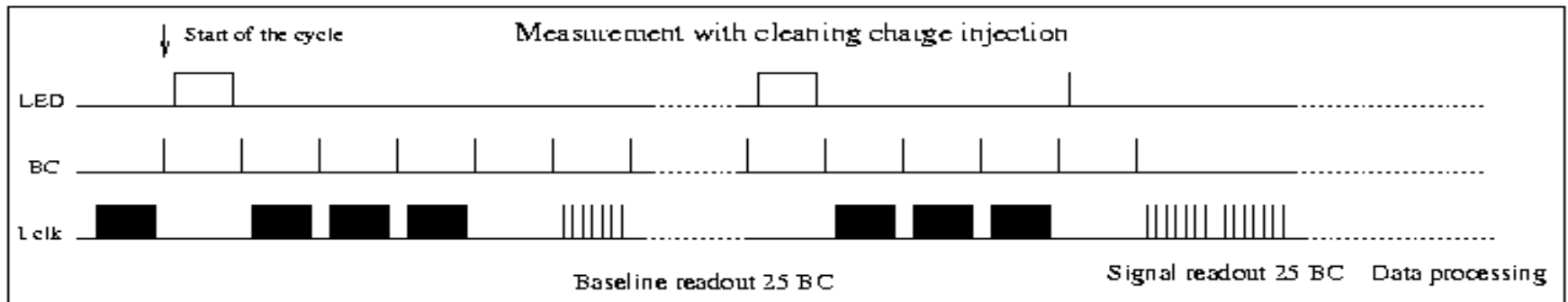
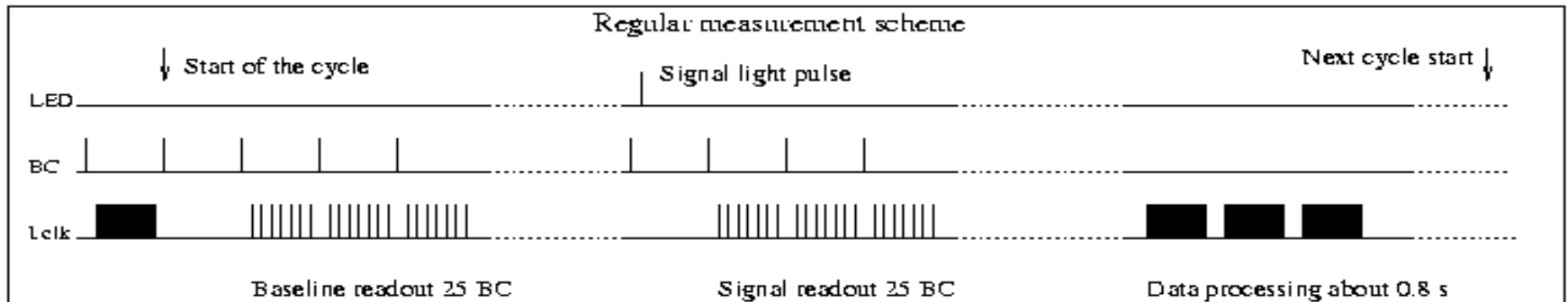

Some results - 1

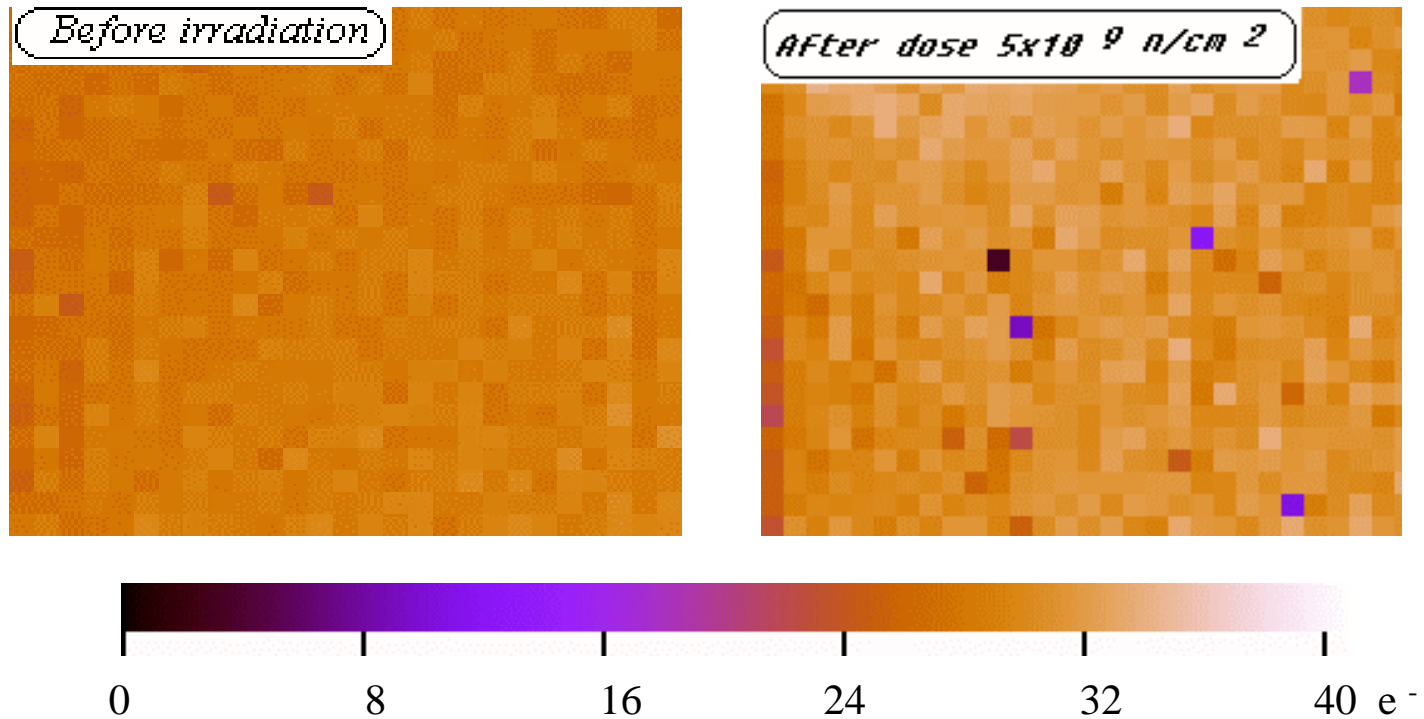

The image read out from the same part of CCD before and after irradiation. Amplitude of the signal in electron charges is coded with color according to scale below images

Some results - 2

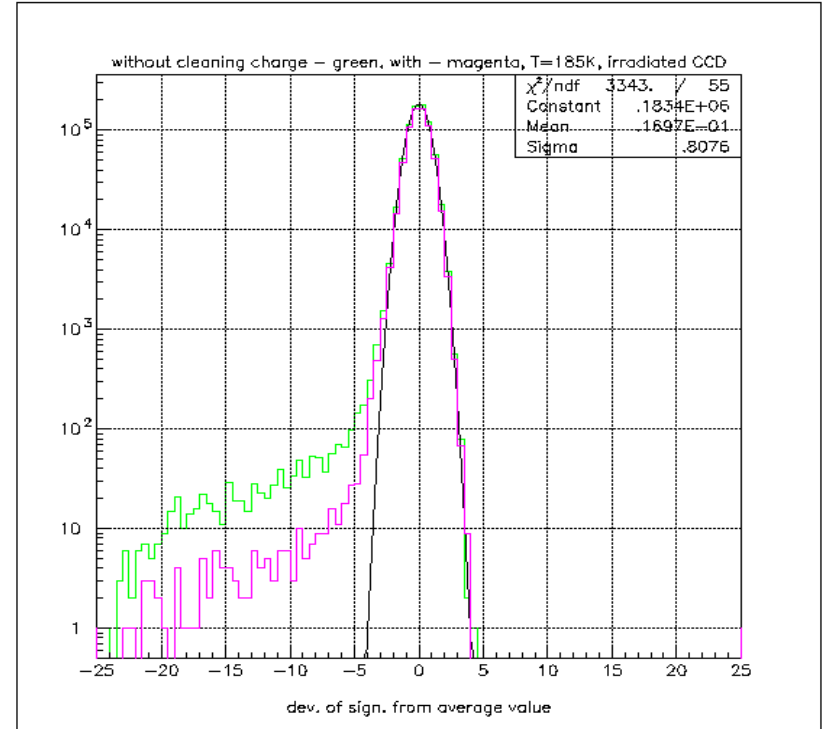
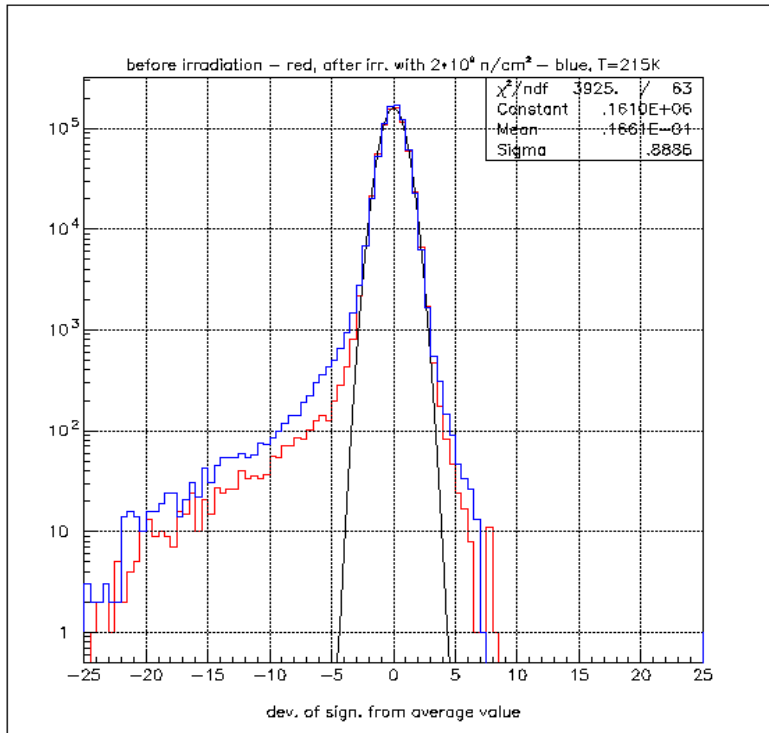

- Deviation of the signal in one pixel from the average signal for surrounding area

Some results - 3

- Traps lifetime

- can tell us energy level of traps: $\tau = e^{(E_c - E_{tr})/KT} / \sigma_n \chi v_n N_c$
not all values in denominator are well known. But:

$$\ln(\tau_1/\tau_2) = (E_C - E_{tr}) * (T_2 - T_1) / K * T_1 * T_2$$

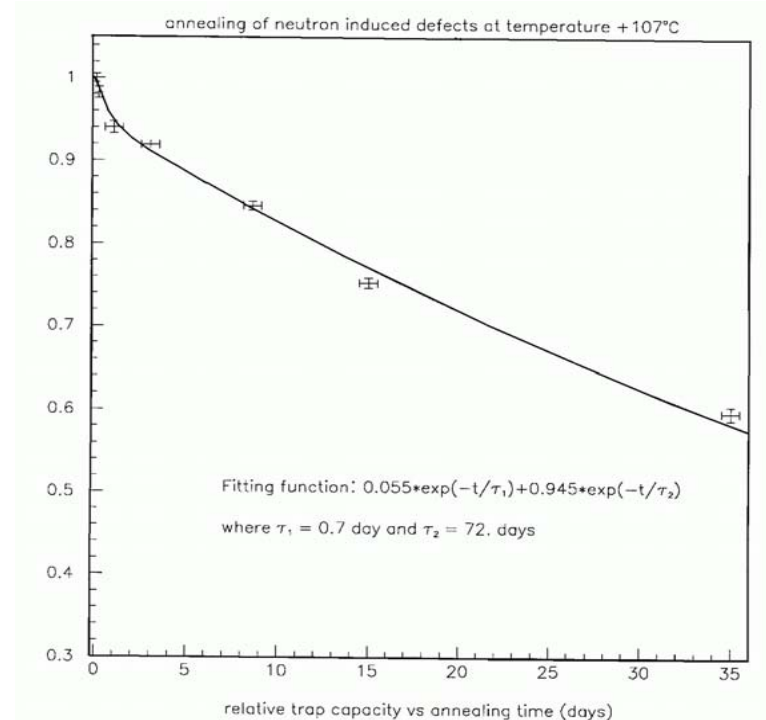
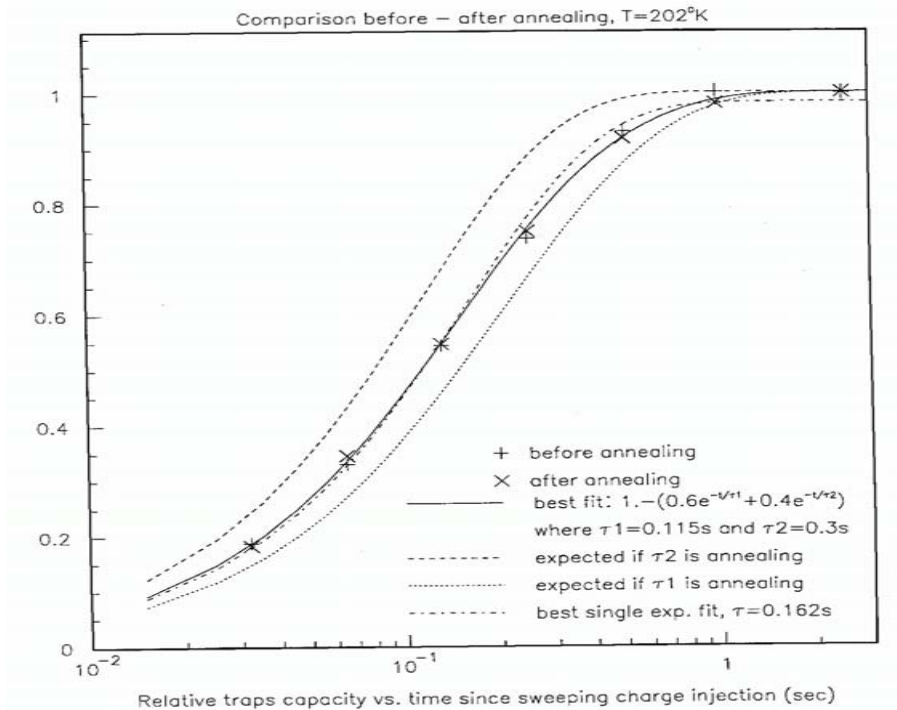

Increasing radiation tolerance of CCDs

- Defect engineering: if it is VP, then adding more oxygen will help.
- Reduction of the width of channel where charge travel – less defects inside channel
- Sacrificial charge injection and keeping working temperature low enough to keep charge traps filled all the time
- CCDs with p-channel
- Fighting voltage shift – reducing thickness of insulator, using “radiation hard” insulator instead of silicon oxide, keeping CCDs unbiased during beam tuning

Plan for more measurements

- First, try to understand if VXD3 suffered neutron or electromagnetic radiation damage
- Do more measurement to confirm or reject conclusion about VP nature of observed damage. Do we see V_2 traps ?
- To answer both of this questions, do similar measurements as we did but with electrons or gamma irradiated CCDs
- Find CCDs made with different technology and do same experiment with them
- Base on gathered experience work with CCD manufacturers on design of more radiation tolerant CCD