

# BIKES-ON-BUS

**Service Delivery in Dade County:  
Suitability and Feasibility**

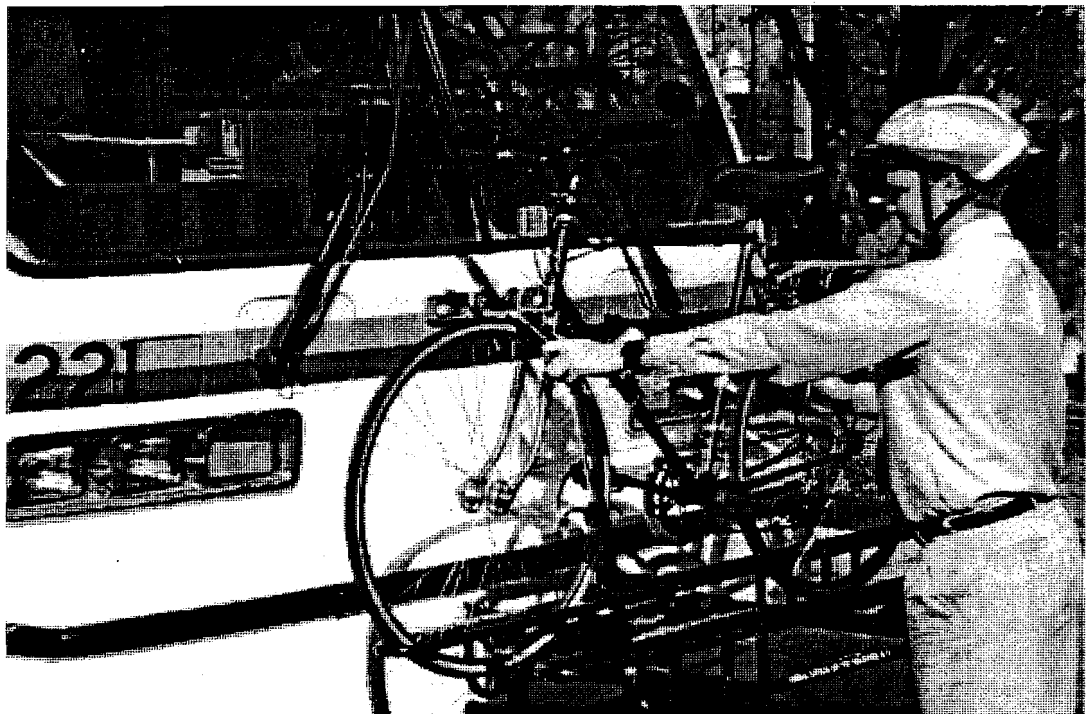

Metropolitan Planning Organization  
for the Miami Urbanized Area



Metro-Dade Transit Agency



Miami, Florida  
April 1995

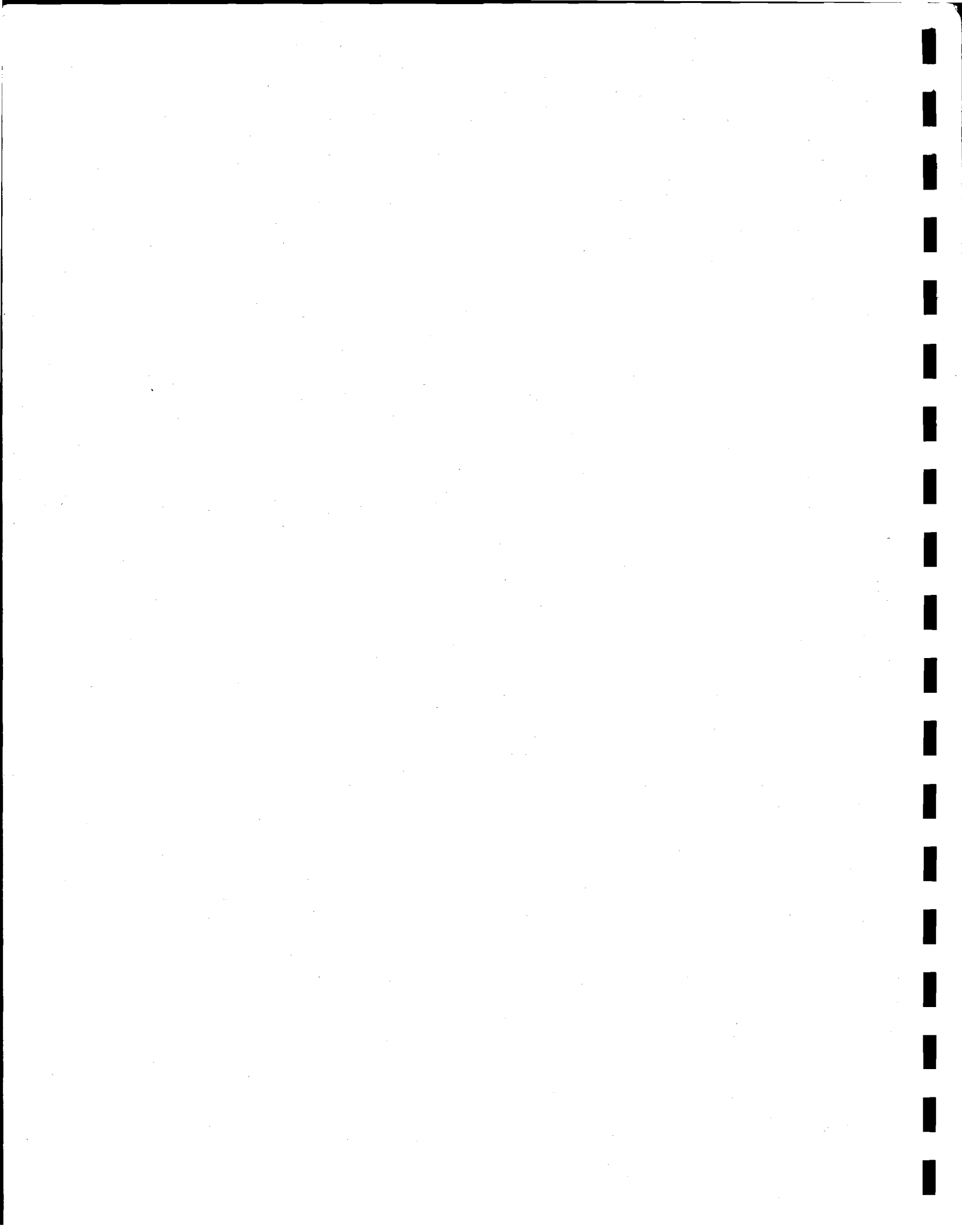

**BIKES-ON-BUS SERVICE DELIVERY  
IN DADE COUNTY:**

**SUITABILITY AND FEASIBILITY**

Prepared for:

Metropolitan Planning Organization of the Miami Urbanized Area

and

Metro-Dade Transit Agency

By:

Center for Urban Transportation Research  
College of Engineering  
University of South Florida

April 1995

## PREFACE

As stated in the Metro-Dade County *Comprehensive Development Master Plan*, the goal for the County's mass transit system is to:

Maintain, operate and develop a mass transit system in Metropolitan Dade County that provides efficient, convenient, accessible, and affordable service to all residents and tourists (revised April, 1993, III-1).

Correspondingly, the Metro-Dade Transit Agency is committed:

To meet the mobility needs of our customers for high quality transit services, which take them where and when they want to go, consistent with prudent business practices. (Transit Development Program, 1993, p. I-1).

According to this framework, the Metropolitan Planning Organization for the Miami Urbanized Area continues to identify and consider new opportunities to improve transit service. At the request of the MPO, the Center for Urban Transportation Research (CUTR), College of Engineering at the University of South Florida, has examined the applicability of the "bike-on-bus" concept to the special conditions of Dade County and has evaluated the feasibility of establishing a countywide bike-on-bus program. The feasibility assessment includes a review of bike-on-bus programs in other American cities as well as detailed analyses of the technology, training, and public information needs that would be required for countywide implementation of such a program.

Recommendations for personnel training curriculum development, demonstration route selection methodology, and methods for monitoring and information collection have been incorporated into this document.

This study is one of several conducted by CUTR under contract with the MPO to provide Dade County technical assistance for a range of projects, including but not limited to:

- applying IVHS technologies to MDTA applications;
- designing survey instruments of Metro-Dade Transit patrons;
- preparing a work program for Metro-Dade Transit joint development master planning;
- evaluating the adoption of a transportation utility fee;
- preparing an MDTA bus operators procedures manual; and
- developing methodologies for forecasting the impact of fare structure changes.

This study, *Bikes-on-Bus Service Delivery in Dade County: Suitability and Feasibility*, may be added to the list, demonstrating the continued interest of CUTR to provide comprehensive technical support services to Dade County on transportation issues of concern.

The following CUTR staff assisted in conducting the analysis and in the preparation of this report:

Project Manager: Sara J. Hendricks, AICP, Research Associate

Project Director: Joel Volinski, Director, Dade Technical Support

Research Assistance: Mitchell York, Research Fellow  
Sara E. Hagge, Graduate Research Assistant  
Martin Catala, Graduate Research Assistant  
Suzanne Dieringer, Graduate Research Assistant  
Joseph Hagge, Graduate Research Assistant  
Janet Becker, Program Assistant  
Rebecca Rahimi, Program Assistant

CUTR Director: Gary L. Brosch

## TABLE OF CONTENTS

<b>LIST OF FIGURES</b> . . . . .	ix
<b>LIST OF TABLES</b> . . . . .	x
<b>EXECUTIVE SUMMARY</b> . . . . .	xi
<b>INTRODUCTION</b> . . . . .	1
The Bike-on-Bus Service Concept . . . . .	1
Metro-Dade Transit Agency Plans . . . . .	3
Study Purpose . . . . .	3
Report Scope and Organization . . . . .	4
Description of Dade County and the Metrobus Transit Program . . . . .	5
Bike-on-Bus Services of Other Florida Transit Systems . . . . .	5
Tallahassee . . . . .	6
Gainesville . . . . .	6
Lee and Hillsborough Counties . . . . .	6
Palm Beach and Broward Counties . . . . .	7
Tri-Rail . . . . .	7
Metrorail Bike on Train . . . . .	7
Identified Issues . . . . .	8
<b>DEMAND ESTIMATION</b> . . . . .	9
Dade County Characteristics . . . . .	9
Transit Ridership Profile . . . . .	9
Bike-on-Bus Service Demand Based On Residential Location Of TD Persons . . . . .	11
Bike-on-Bus Service Demand Based On Residential Location Of Bicycle Commuters . . . . .	14
Bike-on-Bus Service Demand Based On Demographic Characteristics . . . . .	17
Policy Considerations . . . . .	21
Phoenix Bike-On-Bus Trip Making . . . . .	24
Demonstration Route Selection Methodology and Results . . . . .	24
<b>BIKES-ON-BUS EXPERIENCE IN AMERICAN CITIES</b> . . . . .	33
Case Study Selection . . . . .	33
Hillsborough County's HARTline Bike-On-Bus Service . . . . .	37
Broward County Transit . . . . .	38
Bike-on-Bus Programs Of Other States . . . . .	39
Phoenix Case Study . . . . .	40
Demonstration Planning . . . . .	41
Demonstration Evaluaton . . . . .	42
Portland's Bikes on Tri-Met Program . . . . .	43
Demonstration Planning . . . . .	43
Front-Mounted Rack Design . . . . .	44
Bikes-on-MAX Program . . . . .	45
Staff Time Requirements . . . . .	46
Bus Operator Training and Participation . . . . .	46

Safety, Security and Liability .....	47
Performance Evaluation .....	49
Bike-in-Bus Transport Method Reconsidered .....	50
Public Information .....	50
Seattle Metro Bike-on-Bus Service .....	51
Bike-in-Bus Pilot Test .....	52
Vendor Selection Process .....	54
Required Bicycle Rack Features .....	55
Desired But Not Required Bicycle Rack Features .....	55
Planning Implementation .....	61
Bike-in-Bus Programs, San Jose and Sacramento, California .....	66
Sacramento .....	67
Santa Clara County .....	67
Boarding and Loading .....	67
On Board .....	70
Unloading .....	70
<b>EQUIPMENT AND TECHNOLOGIES TO FACILITATE BIKES-ON-BUS SERVICE</b> ..	71
Bus Characteristics .....	71
Bicycle Characteristics .....	73
Bicycle Type .....	73
Bicycle Size .....	73
Bicycle Transport Options .....	76
Bus Luggage Component .....	76
Trailers .....	77
In-vehicle Transport .....	77
Rear-mounted Racks .....	80
Front-mounted Racks .....	81
Front-mounted Rack Styles .....	82
Prong Style Bicycle Rack .....	82
Platform Style Bicycle Rack .....	82
Track Style Bicycle Rack .....	83
Attachment Methods .....	86
Bus Washing .....	88
Rack Design Comparisons .....	89
Recommended Option .....	92
Advertising Panels .....	93
Rack Visibility .....	94
Kneeling Buses .....	94
Bus Towing .....	95
Roadway Characteristics .....	95
Turning Radii .....	95
Other Roadway Features .....	99
Bicycle Parking .....	100

Summary and Recommendations .....	103
Target Market Definition .....	103
Transport Option Selection .....	103
Design Considerations .....	104
Capacity of the rack to accommodate anticipated user demand ...	104
Compatibility of rack mounts with bus bumper assemblies .....	104
Visibility of a deployed rack by the bus operator and other motorists	104
Access to maintenance hatches .....	105
Adequate turning radii .....	105
Visibility of advertising panels .....	106
Compatibility with bus washing facilities .....	106
Performance Specifications .....	106
Technologies of the Future .....	106
<b>PROGRAMMATIC NEEDS .....</b>	<b>109</b>
Selecting Operational Goals .....	110
Safety and Risk Management .....	110
Systematic Inspection and Maintenance .....	111
Accident Documentation and Analysis .....	114
Liability .....	116
Program Costs .....	117
Funding Sources for the Bike-on-Bus Program .....	120
Surface Transportation Program .....	121
Transportation Enhancement Activities .....	121
Congestion Mitigation and Air Quality Improvement Program (CMAQ) .....	124
State Level Transportation Finance and Planning .....	125
Bike-on-Bus Program Team .....	127
Summary .....	128
<b>PUBLIC INFORMATION .....</b>	<b>129</b>
Public Awareness .....	129
Bike-On-Bus Instruction .....	131
Recommended Bike-on-Bus Boarding Procedure	
Bicyclist's Perspective: .....	132
Coordination with Metrorail Bike on Train Service .....	133
Summary .....	134
<b>PERSONNEL TRAINING .....</b>	<b>135</b>
Planning Staff and Managers .....	135
Customer Service Representatives .....	135
Bus Operator Training .....	135
Recommended Bike-on-Bus Boarding Procedure	
Bus Operator's Perspective: .....	141
Bus Maintenance Personnel .....	142
Summary .....	143



**MONITORING THE MDTA BIKE-ON-BUS DEMONSTRATION PROGRAM** . . . . . 145

    CMAQ Funded Projects . . . . . 145

    Measuring Benefits . . . . . 145

    Equipment, Operations and Procedures Fine Tuning . . . . . 146

        Rack Effectiveness . . . . . 146

        Service Schedule Delay . . . . . 147

    Monitoring Safety . . . . . 149

    Beyond The Demonstration . . . . . 150

**BIBLIOGRAPHY** . . . . . 153

**APPENDICES** . . . . . 157

    APPENDIX A: GOVERNMENT POLICY OVERVIEW . . . . . 159

    APPENDIX B: TRANSIT SYSTEMS CONTACTED . . . . . 165

    APPENDIX C: METRO-DADE RESOURCE PERSONS . . . . . 177

    APPENDIX D: TRANSIT SYSTEMS CONTACTED . . . . . 195

    APPENDIX E: METRO-DADE RESOURCE PERSONS . . . . . 197

    APPENDIX F: HARTLINE INSTRUCTIONAL BROCHURE . . . . . 199



## LIST OF FIGURES

<b>FIGURE 1:</b> Census Tract Projections for 1996 Transportation Disadvantaged Persons . . .	12
<b>FIGURE 2:</b> People Biking to Work by Census Tract . . . . .	15
<b>FIGURE 3:</b> Average Daily Bike Trips by Census Tract, bicyclists age 12-60+ . . . . .	20
<b>FIGURE 4:</b> Average Daily Bike Trips by Census Tract, bicyclists age 19-60+ . . . . .	22
<b>FIGURE 5:</b> Seattle Bike Rack Prototype Survey . . . . .	59
<b>FIGURE 6:</b> Metro Racks Up A Great Travel Option: Bike and Ride . . . . .	65
<b>FIGURE 7:</b> Sacramento Regional Transit District, Bicycle Permit Application . . . . .	68
<b>FIGURE 8:</b> Illustration of Bicycle Measurements . . . . .	75
<b>FIGURE 9:</b> Wheelchair Lift Equipped Bus, Typical Overhead View . . . . .	79
<b>FIGURE 10:</b> Platform Style Rack from Sportworks NW, Inc. . . . .	84
<b>FIGURE 11:</b> KOR Track Style Rack Closed Position for One Bicycle . . . . .	85
<b>FIGURE 12:</b> KOR Track Style Rack Extended Position for Two Bicycles . . . . .	85
<b>FIGURE 13:</b> Cut-Away Side View of Bumpers and Brackets for the Flxible and RTS Buses . . . . .	88
<b>FIGURE 14:</b> Turning Radius Template for 40-foot Bus with 36" Front Bicycle Rack . . .	96
<b>FIGURE 15:</b> Turning Radius Template for 60-foot Articulated Bus . . . . .	97
<b>FIGURE 16:</b> Wheelchair Lift Preventive Maintenance Inspection Order . . . . .	112
<b>FIGURE 17:</b> Metrobus Maintenance Flxible 6000 "A" Inspection . . . . .	113
<b>FIGURE 18:</b> Metrobus Operator's Pre-Trip Inspection . . . . .	115
<b>FIGURE 19:</b> Tri-Met Release of Liability and Indemnification . . . . .	118
<b>FIGURE 20:</b> FDOT Application for Transportation Enhancement Projects . . . . .	122
<b>FIGURE 21:</b> HARTline's Kick-Off Event . . . . .	130

## LIST OF TABLES

<b>TABLE 1:</b> Mode of Transportation to Work, Urban Area Comparison . . . . .	16
<b>TABLE 2:</b> Average Annual Bicycle Trips by Demographic Category . . . . .	18
<b>TABLE 3:</b> Number of Persons by Gender/Race/Age Category . . . . .	21
<b>TABLE 4:</b> Initial Route Selection Scores . . . . .	27
<b>TABLE 5:</b> Second Round Route Selection Scores . . . . .	29
<b>TABLE 6:</b> Comparative Transit Data by Motorbus Mode . . . . .	34
<b>TABLE 7:</b> Metro-Dade Transit Agency, Motor Coach Inventory . . . . .	72
<b>TABLE 8:</b> Front Rack Mounting Conditions . . . . .	86
<b>TABLE 9:</b> Comparative Attributes of Four Front-Mounted Bicycle Racks . . . . .	90
<b>TABLE 10:</b> Metrorail Stations and Bus Route Connections . . . . .	102
<b>TABLE 11:</b> MDTA Bike-on-Bus Program Planning Approach Options . . . . .	109
<b>TABLE 12:</b> Number of Bicycle Racks Required . . . . .	119

## EXECUTIVE SUMMARY

As a result of the review and evaluation by CUTR of the service possibilities and potential for bike-on-bus service in Dade County, several conclusions can be drawn and ten primary recommendations can be offered, as summarized below.

1. It is concluded that a bike-on-bus service would be consistent with and reinforce the existing transportation policy framework of Dade County. Because bike/transit service is beginning to be implemented by Broward County Transit and by Tri-Rail, in addition to the existing Bikes on Train service of Metrorail, coordination opportunities exist within MDTA and regionally. Because the bike-on-bus service concept is also consistent with federal transportation policy, there are opportunities for funding assistance for the implementation of bike-on-bus service.
2. Through a detailed evaluation of bicycling activity in Dade County, in addition to a review of demographic characteristics and a profile of existing bus passengers, it is concluded that demand for a bike-on-bus service does exist in Dade County. The market for such a service includes all able-bodied individuals with bicycle riding skills living within bicycling distance of a Metrobus stop, but demand will tend to be strongest among younger, low-income individuals, including students and those employed in blue collar professions.
3. The MPO had requested a recommendation for the selection of three bus routes, to be included as part of a proposed bike-on-bus demonstration program. A review of the bus route selection methodology, developed by the Short Range Intermodal Committee, verifies its applicability in the initial selection of nine demonstration routes out of a total of 69 routes. These bus routes are all served from the same garage and they include 35/70, 40, 48, 52, 56, 65, 71, 73, and 87. From this pool of ten routes, it is recommended that MDTA select routes 73, 48, and 35/70. Two of these routes have been identified as serving a greater number of industrial sites. This is significant, considering the experience of the Phoenix Bike-on-Bus Program, in which new ridership was generated. Their bike-on-bus rider profile showed strong representation of blue collar workers.

In combination, these three routes cover a broad portion of Dade County. They connect with Metrorail and provide bus access to lower-income areas, which generally correspond to areas indicating higher bicycling activity. These recommended routes also provide bus access to areas known as the urban fringe, where higher potential demand for bike-on-bus service may exist, particularly for those who live too far to walk to the nearest bus stop.

4. It is recommended from a detailed evaluation of five identified options for transporting bicycles aboard buses, that MDTA select the front-mounted rack option as its preferred method of bike-bus transport. Although transporting bicycles inside the passenger compartment of buses has the advantage of not requiring additional equipment, testing of

this method of transport by other urban areas, including Seattle, indicates that it competes for passenger space within the bus. Because the interiors of buses are not designed for transporting bicycles, safely securing bicycles inside buses is an issue that has not been resolved.

It is recommended that buses serving selected demonstration routes be equipped with front-mounted racks because their use increases the carrying capacity of the bus and does not interfere with other passengers, particularly passengers with disabilities. Front-mounted racks presently on the market have been designed to be light weight, easily removable, and simple to load and unload by bus passengers. The front-mounted position of the rack enables the bus operator to easily monitor the loading and unloading activity. Greater visibility by the bus operator can be achieved with the placement of an additional mirror. Reflective paint and tape affixed to the bicycle rack can increase its visibility by other motorists.

5. It was determined that there would be no impact on advertising revenues if less than 10 percent of the existing front advertising panels were removed. For purposes of a bike-on-bus demonstration program using three selected bus routes, this would require removing the front advertising panels on 22 buses, or approximately four percent of a total fleet of 612 active buses.
6. Front-mounted bicycle racks extend as much as 36 inches in front of the bus, when unfolded and ready for use. As a result, an additional 24 inches of clearance may be required for turns greater than 90 degrees. A comprehensive identification of narrow intersections and other potential route trouble spots should be undertaken as part of the purpose of a demonstration program and as part of testing rack prototypes under consideration by MDTA for purchase.
7. It is recommended that turning requirements of candidate demonstration routes be reviewed in detail prior to final selection. Turning movement problems can be minimized in three ways:
  1. Familiarization and training of bus operators so that they know how to compensate for any increased space requirements to safely complete a turn;
  2. The use of a staggered stop bar for particularly narrow intersections; and
  3. Positioning the front-mounted rack slightly to the right of the center of the bus.
8. Regarding the selection of front-mounted rack equipment, it is recommended that MDTA carefully define its performance specifications, then select a vendor who will supply a product that will most closely meet the needs of MDTA's demonstration program. The Seattle Metro case study is particularly informative in the manner in which they selected an equipment supplier.

9. It is recommended that instruction of the public regarding the use of the bicycle racks and the rules of the program be conveyed through the development of a permitting program, in coordination with the Metrorail Bikes on Train program. While some concern exists that the inconvenience of acquiring a permit may discourage some users, it is argued in this study that providing instruction is a service that may actually encourage individuals to participate in the program, in addition to inspiring public confidence and promoting safe practices.
10. Finally, it is recommended that a bike-on-bus program team, composed of Metro-Dade staff and other interested citizen group representatives, be assembled to provide guidance during the development and implementation of the demonstration program.





## INTRODUCTION

The concept of allowing bicycles aboard transit is not new. At the turn of the century, urban commuters in many of our nation's larger cities boarded street cars with their bicycles. Interest in the idea is now renewed as many large and small transit agencies across the country are establishing "bike-on-bus" programs. Bicycles can be transported by bus in a variety of ways. The most common method is the use of a bicycle rack mounted to the outside front of the bus. Other less common ways include the use of rear-mounted bicycle racks, the allowance of bicycles inside the bus, and the use of trailers.

While some surveys, such as the 1990 *Nationwide Personal Transportation Study* (NPTS) and a 1993 sales survey of the Bicycle Manufacturers Association of America<sup>1</sup>, suggest that the overall amount of bicycling activity nationwide has remained generally constant over the past several years, greater promotion and coverage of bicycling as a transportation alternative now seen in the popular media may stimulate increased use.<sup>2</sup> Bicycling equipment is evolving to provide for the preferences of the commuting cyclist, including greater comfort, speed and stability.

### THE BIKE-ON-BUS SERVICE CONCEPT

A bike-on-bus service provides the link between fixed-route bus service and bicycle travel, in order to increase the opportunity to use both modes and to extend the service range for bus travel by making more trip origins and destinations within the reach of a bicycle trip from the bus stop.

A bike-on-bus program extends the service range of bus transit where the bicycling link can best complement bus service. A bike-on-bus program can give confidence to a bicyclist by serving as "back-up" transportation in the case of bad weather or mechanical problems.

It can help transit to better serve urban areas built at lower densities. It can enhance public relations as a highly visible service that responds to particular customer needs.

A bike-on-bus program can provide additional service to the existing bus ridership who may presently find the walk to the bus stop or the walk to their final destination from the bus too uncomfortable or lengthy. Now they can bicycle to the bus stop, transport their bicycles safely with them during the bus trip, then bicycle to their final destination. This saves the passenger travel time and increases his mobility at his destination.

---

<sup>1</sup> Results published by Bicycle Institute of America, *Bicycling Reference Book*, 1993-1994 (Washington, D.C.): 7.

<sup>2</sup> For example, see "A Greenway to Go to Work and a Workout Too," *Consumer Reports*, Vol. 59, No. 8 (August, 1994): 515.

The bike-on-bus service may attract new ridership by expanding the service area of a bus stop, especially at the fringe areas of bus service. Perhaps once considered too far to walk to the nearest bus stop from home or from the bus stop to the final destination, a commuter may now be able to take advantage of bus service. With increased mobility at the destination, the bus passenger may now find greater employment and other opportunities within the reach of a bicycle ride.

For automobile commuters who would rather not endure the aggravation of driving in congestion and the greater expense of automobile operation, the enhanced effectiveness of both bicycling and bus transit modes achieved by the bike-on-bus service may persuade some motorists to shift travel modes. As bicycling becomes physically easier to increasingly health conscious consumers and as bus transit service continues to improve, the combining of bike and bus modes to complete a journey may prove to be an effective travel option for some people.

While the average person trip length for all trip purposes by bicycle in Florida is 1.36 miles, the average person trip length in Florida across all modes is 8.24 miles.<sup>3</sup> Bicycle and bus modes may be combined to provide for the need to travel the longer distance. As automobile congestion continues to increase, all the above conditions may point to the feasibility and attractiveness of bike-on-bus service provision for customers of the Metro-Dade Transit Agency (MDTA).

Bike-on-bus programs planned by municipalities adjacent to Dade County have cited additional advantages, such as avoiding the portion of a journey with the heaviest traffic, reducing the number of required transfers, or reducing exposure to heat or inclement weather.<sup>4</sup> Dade County in Florida enjoys such bicycling advantages as mild weather during three seasons of the year and flat topography. Given all these perceived advantages of the bike-on-bus service concept, how might such a program apply to Dade County?

Some research suggests that the mode choice of travelers may depend more upon the strength of public policy and government support for developing alternative modes than upon climate, geography, income, technology or degree of urbanization.<sup>5</sup> A starting point of this investigation was to look at the policy framework at the federal, state and local levels to see how a bike-on-bus program would be consistent. A summary of this information is provided in Appendix A, Government Policy Overview. The investigation concludes that support for bicycling in combination with transit is now appearing in public policy at all government levels. The policies of MDTA were then reviewed.

---

<sup>3</sup> Center for Urban Transportation Research, *NPTS Demographics & Travel Behavior, A Comparison of Florida and the United States*, January 1993 (College of Engineering, University of South Florida): 27.

<sup>4</sup> Kathleen Kernicky, "Bicyclists to get a lift from Broward buses, Tri-Rail," *Sun Sentinel* (July 20, 1994): 7B.

<sup>5</sup> John Pucher, "Urban Travel Behavior as the Outcome of Public Policy: The Example of Modal Split in Western Europe and North America," *Journal of the American Planning Association* (Chicago, IL): Autumn, 1988.

## METRO-DADE TRANSIT AGENCY PLANS

The MDTA Strategic Management Plan lists as one of the strategies, to "Develop and implement a coordinated, fully integrated transportation system with easy transfers between transit modes and other elements of the area's transportation system."<sup>6</sup>

MDTA's Transit Development Program incorporates this strategy as part of a principle objective regarding intermodalism and its supporting policies:

### **Objective 4: Intermodalism**

Encourage ease of transfer between mass transit and all other modes, where it improves the functioning of the transportation network.

#### *Policies*

Mass transit facilities shall incorporate provisions to enhance ease of transfer with other modes (e.g., park-ride garages and lots, commuter rail, airport, pedestrian walkways, taxi and jitney stands).

Highway improvements shall be designated to include provisions for the location of bus turnout bays, bus shelters, High Occupancy Vehicle (HOV) lanes, and other associated facilities to accommodate mass transit services.<sup>7</sup>

While the above MDTA policies do not specifically cite bike-on-bus service as an example, such service has been employed as a means to enhance intermodalism in other urban areas.

Both the summary of MDTA policies above and Appendix A, Government Policy Overview, document a policy climate at the federal, state and local levels that appears favorable to instituting a bike-on-bus service. Conceptually, a bike-on-bus demonstration program would be consistent with and support the current policy framework.

## STUDY PURPOSE

The purpose of this study is to determine how a bike-on-bus program for Dade County can enhance transit service and to identify ways to make such a program successful and efficient.

---

<sup>6</sup> Metro-Dade Transit Agency, "Strategic Management Plan, Executive Summary," January 1991.

<sup>7</sup> Metro-Dade Transit Agency, "Transit Development Program 1993," Miami, Florida, (Revised July 15, 1993): I-3.

This study addresses several indicators that may suggest the degree of usefulness and feasibility of a bike-on-bus program. In addition to the above discussion of conceptual consistency of government goals and objectives, other indicators include;

- the extent to which a bike-on-bus program can increase the bus transit service area;
- the existence of markets for bike-on-bus service;
- the availability of funding opportunities;
- the applicability of experience of bike-on-bus programs of other communities; and
- the nature and extent of program implementation needs.

One aspect of careful planning and testing of the bike-on-bus service concept that is incorporated as part of this study is the development of recommendations for a bike-on-bus demonstration program. In many ways, a carefully designed demonstration program of defined duration and coverage can mimic the essential aspects of a systemwide program without the risk of large scale resource commitments. It is a means not only to test overall program feasibility but also to provide the needed information and experience for identifying and implementing program improvements and for fine tuning procedures.

Another aspect of this study includes recommendations for the development of training materials for MDTA personnel, recognizing safety first, then the role that personnel play in the success of a demonstration program.

## **REPORT SCOPE AND ORGANIZATION**

The scope of this report has been limited to studying bus transport of the range of regular adult size and children's two-wheeled bicycles, including touring bicycles and hybrid bicycles commonly sold today. This report does not examine bus transport of tricycles, folding wheelchairs, tandems or motor scooters. This study has also assumed that those buses under review for bike-on-bus equipment do not include paratransit coaches.

This report is divided into eight sections. After a presentation of introductory background about the bike-on-bus concept, a description of Dade County and the Metrobus transit program, the second section presents an estimation of customer demand potential for a bike-on-bus service. The third section presents a review of bike-on-bus programs established in other urban areas that may serve as instructive examples to Dade County. The fourth section presents an evaluation of equipment and technologies available for use in a bike-on-bus program. The fifth section identifies programmatic needs with respect to bike-on-bus program operations. The sixth section presents recommendations for informing the public about the availability of the bike-on-bus service and its proper use. The seventh section provides recommendations relating to the training of MDTA personnel. In the last section, recommendations are given for program monitoring and information collection.

## **DESCRIPTION OF DADE COUNTY AND THE METROBUS TRANSIT PROGRAM**

It is useful to first describe Dade County demographics and transportation service characteristics in order to provide some context for an evaluation of the feasibility of a bike-on-bus service. Such information also helps to identify similar characteristics of other urban areas that have bike-on-bus programs, to aid in the selection of case studies. The discussion below provides pertinent information on existing characteristics.

MDTA serves a transit service area population of over 1,735,000, covering 285 square miles, including downtown Miami, large commercial and residential areas and farmland in the south and west portions of the county.<sup>8</sup> The multimodal system is comprised of Metrobus, Metrorail, Metromover and privately contracted special transport systems. Currently 75 percent of the urbanized area in the county is served by the existing transit system.<sup>9</sup>

The Metrobus fleet consists of 612 buses that cover 73 routes, including one midday only route and nine peak hour routes. Of the existing routes, 25 routes operate at 15-minute headways or less during peak periods, 28 routes operate at 16- to 30-minute headways and 20 routes operate with headways of 30 minutes or greater.<sup>10</sup> Such routes are served by over 1,322 miles of public roadways. The 1992-93 annual ridership was 64,133,907 passengers. Eight active Metrobus park-and-ride facilities, providing 1,767 parking spaces, serve express bus routes.

All of the buses in the fleet are serviced from three garages. The buses are in operation 24 hours a day Saturday and Sunday and from 4:30 AM to 2:30 AM Monday through Friday. MDTA customers represent diverse cultures, including Spanish and Creole speaking people. Many customers are tourists, the elderly, and persons with disabilities.

MDTA also provides a Bike-on-Train program described later in this chapter.

## **BIKE-ON-BUS SERVICES OF OTHER FLORIDA TRANSIT SYSTEMS**

As the accommodation of bicycles on transit is increasing throughout the nation due in part to the impetus provided by ISTEA funding, several urban transit systems in Florida are planning for bike-on-bus services. Examples are provided below that demonstrate the recent introduction

---

<sup>8</sup> U.S. Dept. of Transportation. Section 15 Annual Report. Tables 25 and 26. Federal Transit Administration, (December 1993) and MDTA Transit Safety and Assurance Division System Safety Program Plan, July, 1992, p.10.

<sup>9</sup> MDTA, "Metro-Dade Transit Agency Transit Development Program." (Revised July 1993): III-1, III-6.

<sup>10</sup> Center for Urban Transportation Research, "MDTA On-Board Survey Analysis: Final Report" (May 1994): 5, 31-41.

of bike-on-transit service to Florida communities, and an overview of the issues that program planners have identified.

### **Tallahassee**

A bike-on-bus program was recently approved by the City Commission of Tallahassee. TALTRAN has selected eight of their 37 bus routes for a demonstration program, based upon serving a target market of a large student population. TALTRAN has selected the use of front-mounted bus racks. Planners have cited concerns about interference by the bicycle racks with the bus washing assembly and the impact of the front-mounted bicycle rack on the ability to make sharp turns at some intersections.

### **Gainesville**

The Regional Transit System (RTS) in Gainesville is also considering a bike-on-bus program. Gainesville has a large bicycling community of all ages. Many college students have expressed interest that bus routes serving the University of Florida be selected for bike-on-bus service. Many school-age children ride the public bus system to school. RTS is beginning to consider issues relating to bus operator training and to the appropriate ages of bus passengers using the bike-on-bus service. The City, which is self-insured, has hesitated to accept the idea based upon liability concerns. RTS has investigated various types of front-mounted racks, with some interest initially shown toward Portland Tri-Met's rack design, but RTS has not yet selected a specific manufacturer.

### **Lee and Hillsborough Counties**

LeeTran, serving the urbanized area of Ft. Myers, started a bike-on-bus program in July, 1994. In response to numerous phone calls from customers inquiring whether certain routes had bicycle racks, LeeTran equipped all twelve routes with front-mounted racks. LeeTran does not require training or permitting of bike-on-bus customers. LeeTran is serving an average of 12 bicyclists per day. The Orange 50 Route has demonstrated the highest bike-on-bus ridership. This route runs along U.S. 41 through the heart of Ft. Myers and the urbanizing areas to the south. To date, there have been no problems with maintenance and bus washing due to the front-mounted racks. Bus operators were instructed in the use of the bicycle racks during initial installation on the buses. Bus operators do not load or unload bicycles. No safety incidents have been reported and no complaints concerning the bike-on-bus service have been received. It was observed that many patrons using the bike-on-bus service have become regular users of the service. LeeTran staff believe that this regular ridership contributes to on-time schedule performance since these patrons become quickly skilled in the use of the rack.

HARTline of Hillsborough County is equipped its entire fleet of 170 buses with front-mounted racks after initial equipment testing identified a rust problem that required parts alterations. HARTline has identified numerous markets for the new service and has established a citizens task force to consider the training needs of the public to use the new service, including the development of a permitting program. More detailed information about HARTline's Bikes on Buses program is given later in this report.

### **Palm Beach and Broward Counties**

Palm Beach County officials and staff are now discussing the service possibilities of a bike-on-bus program. Directly to the south, Broward County Transit is conducting initial planning for a bike-on-bus program to complement their policy of developing bicycle facilities as part of new roadway improvement projects. Broward County Transit has selected one route as a demonstration of the use of bicycle racks mounted to the front of the bus. More detailed information is provided about Broward County Transit in the case studies presented later in this report.

### **Bike-on-Rail Programs**

Bike-on-rail programs were also identified because two such programs are local to Dade County. There may be some overlap of issues of concern and it may be desirable to identify areas for coordinated programming.

#### *Tri-Rail*

South Florida's regional commuter rail system, Tri-Rail, which also serves Dade County, is presently considering the implementation of its own bike-on-rail program. Since many of their passengers are students who may not own automobiles, the accommodation of bicyclists is proposed as a means to boost ridership, especially on weekends. Consideration is being given to equip one or more rail cars with bicycle racks on the end opposite to the wheelchair ramp access. Bicyclists would be able to sit next to their bicycles. In addition to retrofitting existing train cars, new train cars have been purchased that are equipped to carry two bicycles each. Tri-Rail's goal is to make every train bicycle accessible. Train stations would be equipped with bicycle storage lockers. The *Tri-County Commuter Rail Authority Bicycle Plan* is being updated prior to presentation to their Board of Commissioners for approval.

#### *Metrorail Bike on Train*

Bicycle transport by transit has actually been in operation in Dade County since 1983. The Bike on Train program is available to Metrorail passengers. The Bike on Train service is restricted

to nonpeak hours on weekdays and all hours of operation on weekends and holidays. The Metrorail stations also provide bicycle lockers at the larger stations and racks at all other stations. More information about Metrorail Bike on Train is provided later in this report.

## **IDENTIFIED ISSUES**

Because the bike-on-bus programs of transit systems in Florida are all in the demonstration planning stages, their program decisions have been based upon the experience of bike-on-bus programs in urban areas out-of-state. It is too early to show demonstrated results from Florida bike-on-bus programs; therefore, there is little documented local experience to guide Metro-Dade Transit Agency. This provides a good reason to look to programs of other states that are better established. These case studies are found later in this report. However, the investigation of Florida programs helped to identify a number of topics of concern. These included:

- identifying markets and demand level for the service;
- selecting the means to provide timely information to the public;
- selecting effective avenues for public participation;
- choosing appropriate equipment selection;
- identifying needed amenities to complement a bike-on-bus service;
- selecting appropriate hours of operation of the bike-on-bus service;
- defining bus operator responsibilities;
- measuring the impact of bicycle transport methods upon bus operations;
- determining the degree of interference of bicycle transport options upon bus wash assemblies;
- selecting the appropriate ages of bus passengers to use the bike-on-bus service;
- determining liability of the transit agency for property damage or injury resulting from the use of the bike-on-bus service;
- determining the degree of training required by MDTA staff and bus passengers;
- developing methods to enforce compliance with program rules and procedures;
- identifying maintenance needs of bicycle transport equipment;
- assessing the impact of a bike-on-bus service upon schedule adherence; and
- designing methods to evaluate effectiveness of the program.

These topics and others are addressed initially with information contained in the case studies featured. The next chapter addresses the first topic on the list: identifying markets and demand level for a bike-on-bus service in Dade County.



## DEMAND ESTIMATION

The purpose of this chapter is to determine whether a market exists in Dade County for a bike-on-bus service. For example, it would be prudent for a transit agency to decide against establishing a bike-on-bus service if it were determined that potential demand for such service were negligible. This study has determined that demand does exist for a bike-on-bus service. While it is cautioned that results from this study are not conclusive regarding the Dade County locations of *highest* demand for the bike-on-bus service, the analysis does indicate several generalized areas where greater bicycling activity presently occurs relative to other locations. This analysis used several types of data to attempt to pinpoint locations of greater existing bicycling activity. This included mapping areas where transportation disadvantaged (TD) persons reside because the Nationwide Personal Transportation Study (NPTS) indicates that bicyclists (and pedestrians) are more likely to have lower household incomes than motorists. The analysis also included mapping residential locations of persons who bicycle to work, as indicated by the 1990 Census. Finally, this analysis included estimating the number of bicycle trips by census tract based upon average bicycle trip making activity by demographic category nationwide.

This chapter begins with county demographic data and a brief profile of MDTA bus passengers, describes the existence of bike-on-bus markets, and concludes with a discussion of a bike-on-bus demonstration route selection methodology and recommendations.

### DADE COUNTY CHARACTERISTICS

An estimated 1.7 billion bicycling trips were made nationwide in 1990. This represents 0.7 percent of all trips made. The average trip length by bicycle is 2.0 miles.<sup>11</sup> Detailed bicycle trip making data, including origin/destination information and bicycle trip volumes, is usually unavailable at the local level. A database of such information is beginning to develop for Dade County as increased attention focuses upon bicycle transportation planning. For example, bicycle traffic volume counts were conducted at 45 locations in Dade County by FDOT, during November and December, 1994. However, because information is still of limited availability and comprehensiveness, the analysis in this report uses Dade County demographic characteristics and data from the 1990 Census and Nationwide Personal Transportation Study to estimate the existence of demand for bike-on-bus travel. The discussion below examines Dade County characteristics.

According to the 1990 U.S. Census, the population of Dade County is 1.9 million with an expected increase of 0.22 million people by 1997. The employment figure from 1990 is 1.1 million workers and is expected to increase 4.8 percent, by 1997. Currently, 95 percent of the residents reportedly work within their home county. Population growth is mainly occurring at

---

<sup>11</sup> Nationwide Personal Transportation Study, 1990.

the edges of the urbanized areas. Approximately 94 percent of the employment locations are contained in the transit service area. According to county projections, the employment growth through 1997 will occur almost exclusively within the current service area. While many transit-dependent individuals live in the current transit service area, others live at the urban fringe beyond the outer boundaries of transit service.<sup>12</sup>

Since most employment growth is occurring within the existing service area, stronger transportation links to the urban fringe may help connect employment opportunities and services to transit-dependent individuals.

### **Transit Ridership Profile**

In Dade County, propensity to use transit is strongly influenced by ownership and availability of an automobile. Some of the major factors that influence vehicle ownership include income, age, health and disability. The individuals that do not own automobiles must rely on others or the public transit system to fulfill their transportation needs.<sup>13</sup> There are 262,986 low-income individuals, according to 1992 data, not including the disabled or elderly.<sup>14</sup>

Approximately 77 percent of Metrobus patrons are between the ages of 16 and 49; however, in the general Dade County population this group accounts for only 49 percent. Approximately 57 percent of the Metrobus passengers are female which is close to the county population figure of 52 percent. The annual household income of 37 percent of the riders is less than \$10,000. Of the total Dade County population, 19 percent of the households fall into this category. Approximately 42 percent of Metrobus passengers belong to households of four or more, while the 1990 Census reports that 28 percent of all households in Dade County had four or more members. Approximately 44 percent of the surveyed Metrobus passengers report that their households do not own automobiles while 16 percent of Dade County households reported not owning an automobile.<sup>15</sup>

In summary, Metrobus passengers, compared to the general Dade County population, are generally younger, with a household income lower than that for the general Dade County population, and with a greater chance of not owning an automobile. Bus riders represent a higher

---

<sup>12</sup> Metro-Dade Transit Agency, "Transit Development Program," (Revised July 1993): III-1, III-6.

<sup>13</sup> Center for Urban Transportation Research, "MDTA On-Board Survey Analysis: Final Report," College of Engineering, University of South Florida (May 1994): 5, 31-41.

<sup>14</sup> Center for Urban Transportation Research, "Dade County Five-Year Transportation Disadvantaged Plan 1992-1996: Final Report," College of Engineering, University of South Florida (August 1992): 11.

<sup>15</sup> Center for Urban Transportation Research, "MDTA On-Board survey Analysis: Final Report," College of Engineering, University of South Florida (May 1994): 5, 31-41.

proportion of younger people. Correspondingly, more bicycle trips tend to be made by bicyclists in the younger age categories.

Bus transit trips that originated at home accounted for 54 percent of the bus travel. Approximately 22 percent of reported trips had originated at work. Of the reported destinations 37 percent were homebound, 32 percent were headed to work, 9 percent to school and 8 percent to shopping. Approximately 72 percent of Metrobus passengers ride the bus five or more times per week. Of the surveyed passengers, 76 percent walk to the bus stop. This includes 59 percent who walk three or less blocks to the stop and 17 percent who walk more than three blocks. The results are similar for the egress portion of the trip. Approximately 47 percent of the passengers walk three blocks or less and 17 percent walk more than three blocks to reach their destination. The remaining percentages are made up of the passengers that are transferring from bus or rail or are being dropped off. Metrobus serves as the only motorized mode of transportation for a large number of the passengers using it to reach their destination. However, some riders use additional modes of public transportation as well. Approximately one fourth of the passengers reported transferring to Metrorail or Metromover, but approximately half of the passengers use only the Metrobus to get to their destinations with a short walk on one or both ends of the trip. Another 17 percent walk more than three blocks on one or both ends of their journey.<sup>16</sup>

There are many characteristics of passengers that would identify them as possible candidates for a bike-on-bus service, including those who are able-bodied and possess bicycle riding skills. While many potential customers of a bike-on-bus service may own an auto, a potential market for the service are those who do not have access to an auto and those who are neither elderly nor disabled and who have low household incomes.

Information characterizing the potential market for a bike-on-bus service was derived from the 1990 NPTS data, the 1990 Census Journey to Work data, an MDTA On-Board Survey conducted by CUTR and user profiles from highlighted case studies.

## **BIKE-ON-BUS SERVICE DEMAND BASED ON RESIDENTIAL LOCATION OF TD PERSONS**

Service demand may vary by market location and the needs of the market, such as time of day and day of week service is most desired. Figure 1, entitled "Census Tract Projections for 1996 Transportation Disadvantaged Persons", illustrates the estimated comparative number of persons by census tract location who earn low incomes and are neither elderly nor disabled. These individuals have been identified as a possible market for a bike-on-bus service because of the

---

<sup>16</sup> Center for Urban Transportation Research, "MDTA On-Board Survey Analysis: Final Report," College of Engineering, University of South Florida (May, 1994): 5, 31-41.

Figure 1

# Dade County, Florida Census Tract Projections for 1996 Transportation Disadvantaged (Non-Disabled, Non Elderly, Low Income Category)

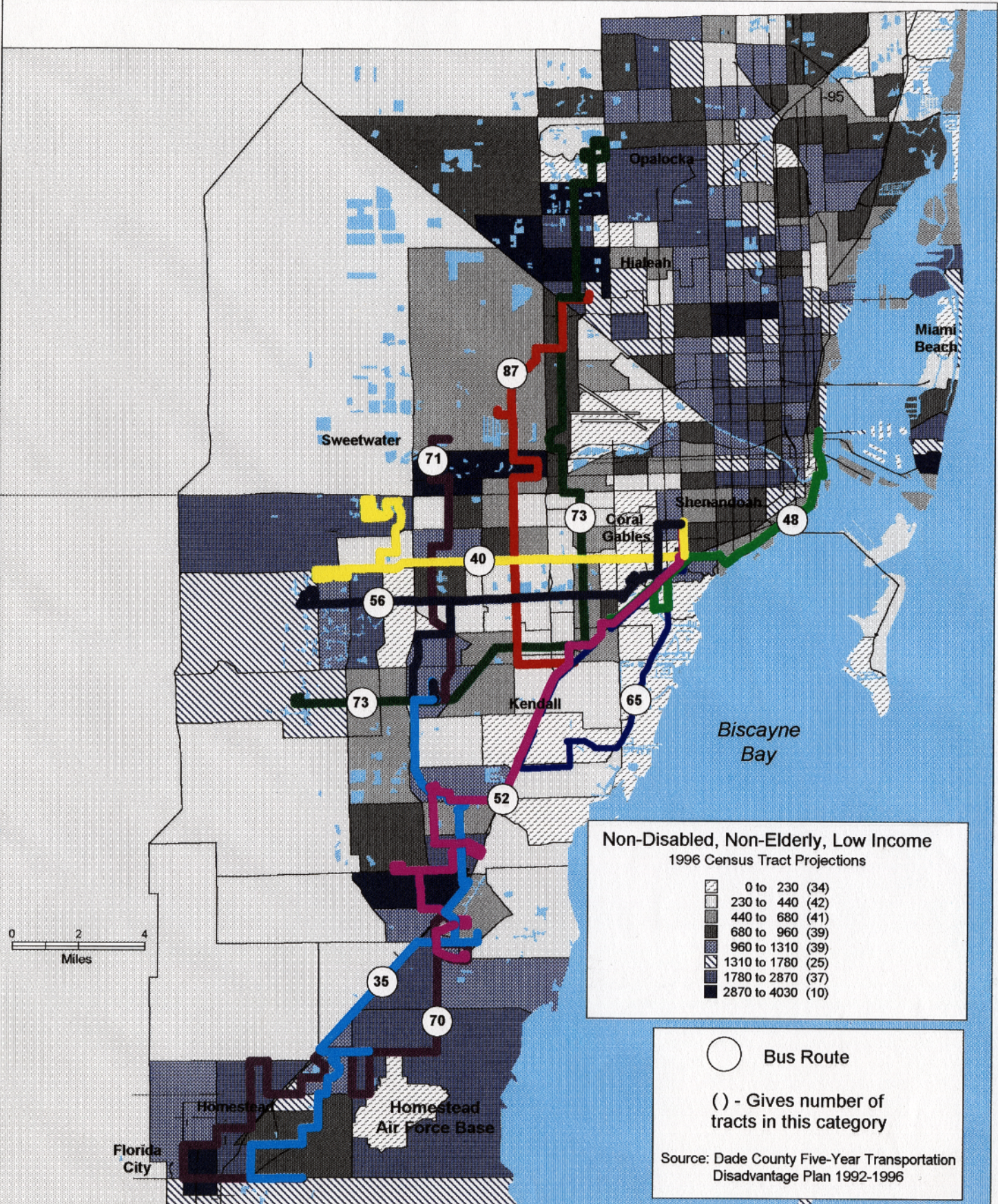

Figure 2

# Dade County, Florida People Biking to Work by Census Tract

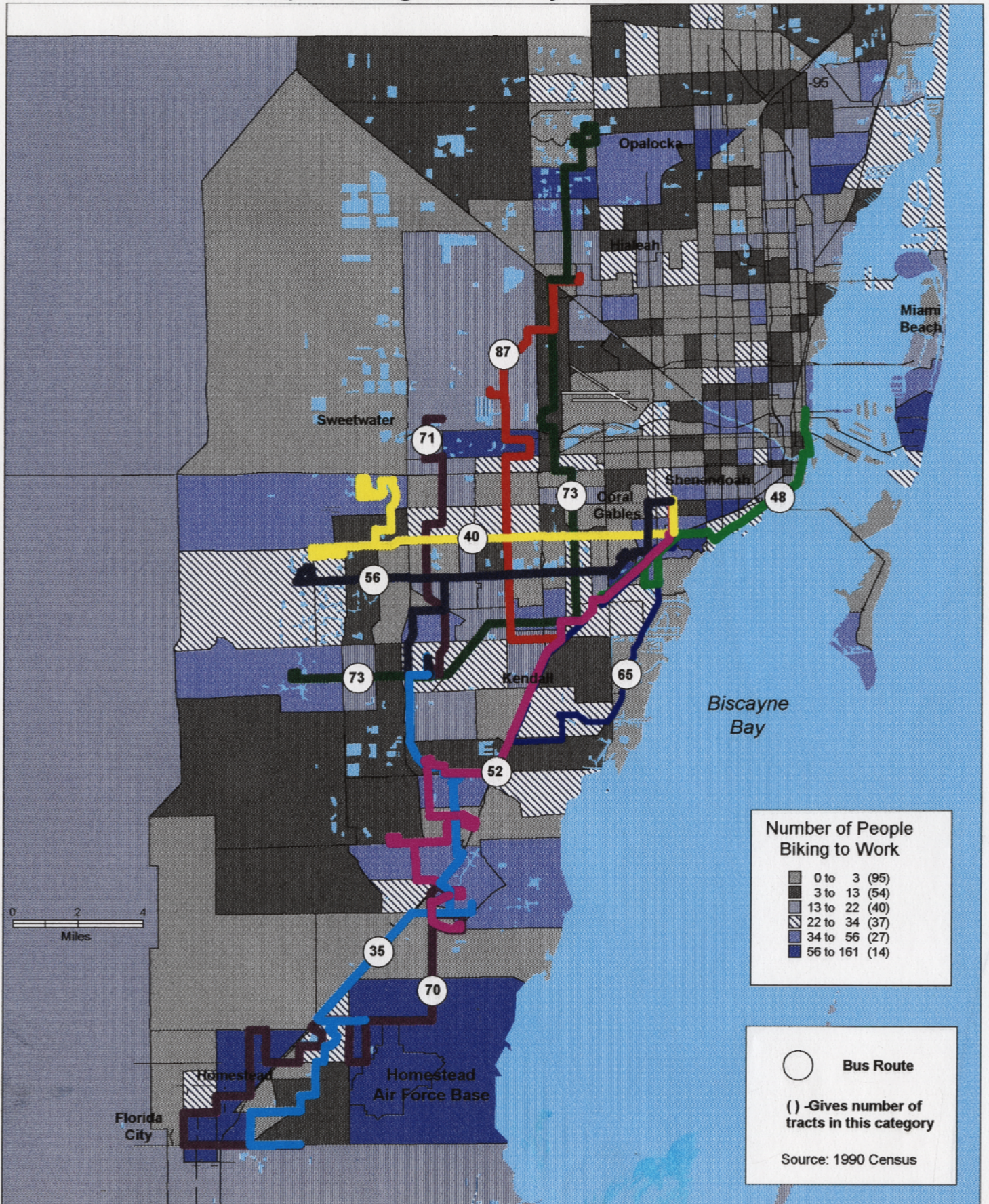

Figure 3  
**Dade County, Florida**  
**Average Daily Bike Trips by Census Tract**  
 (Bicyclists age 12-60+)

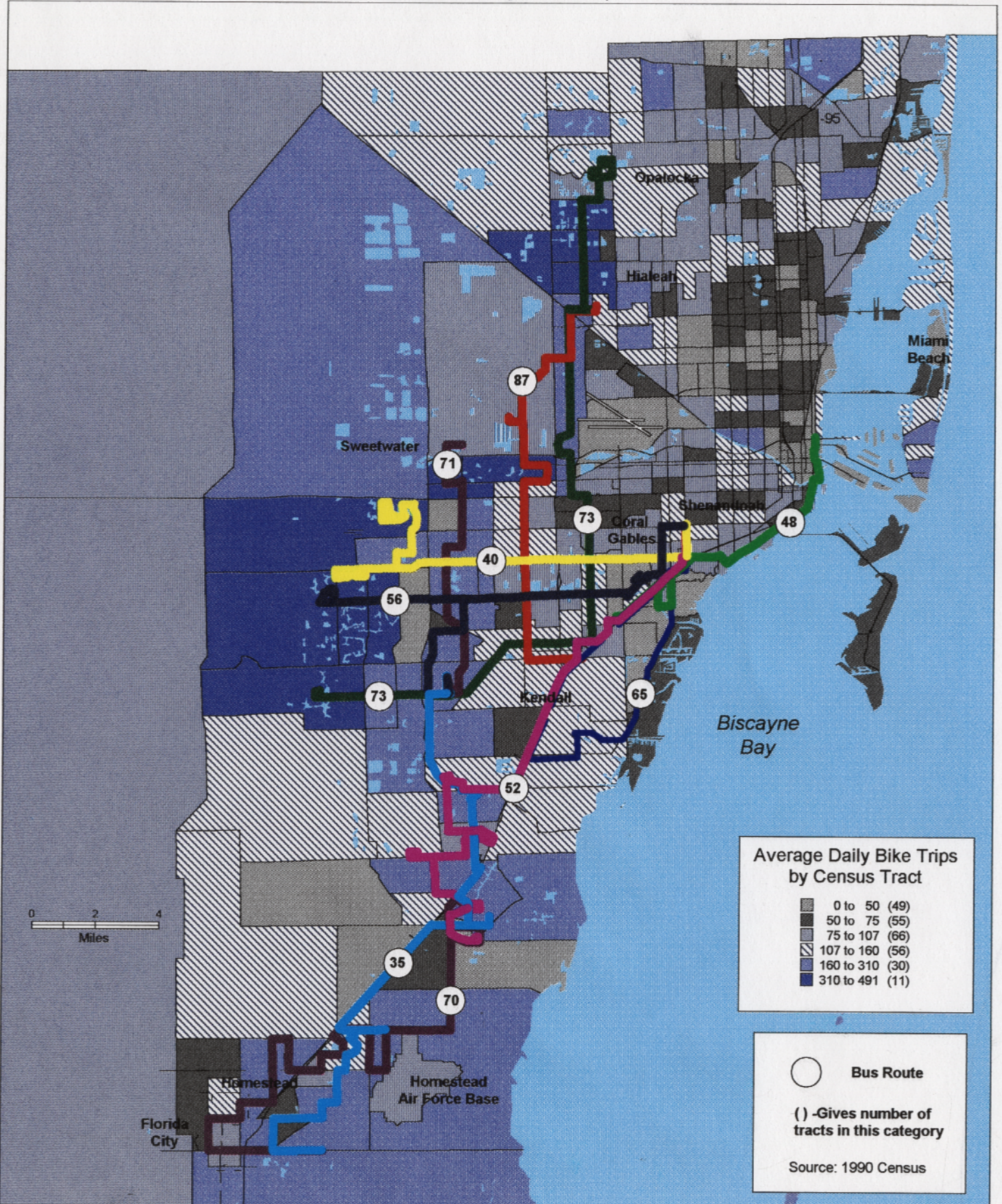
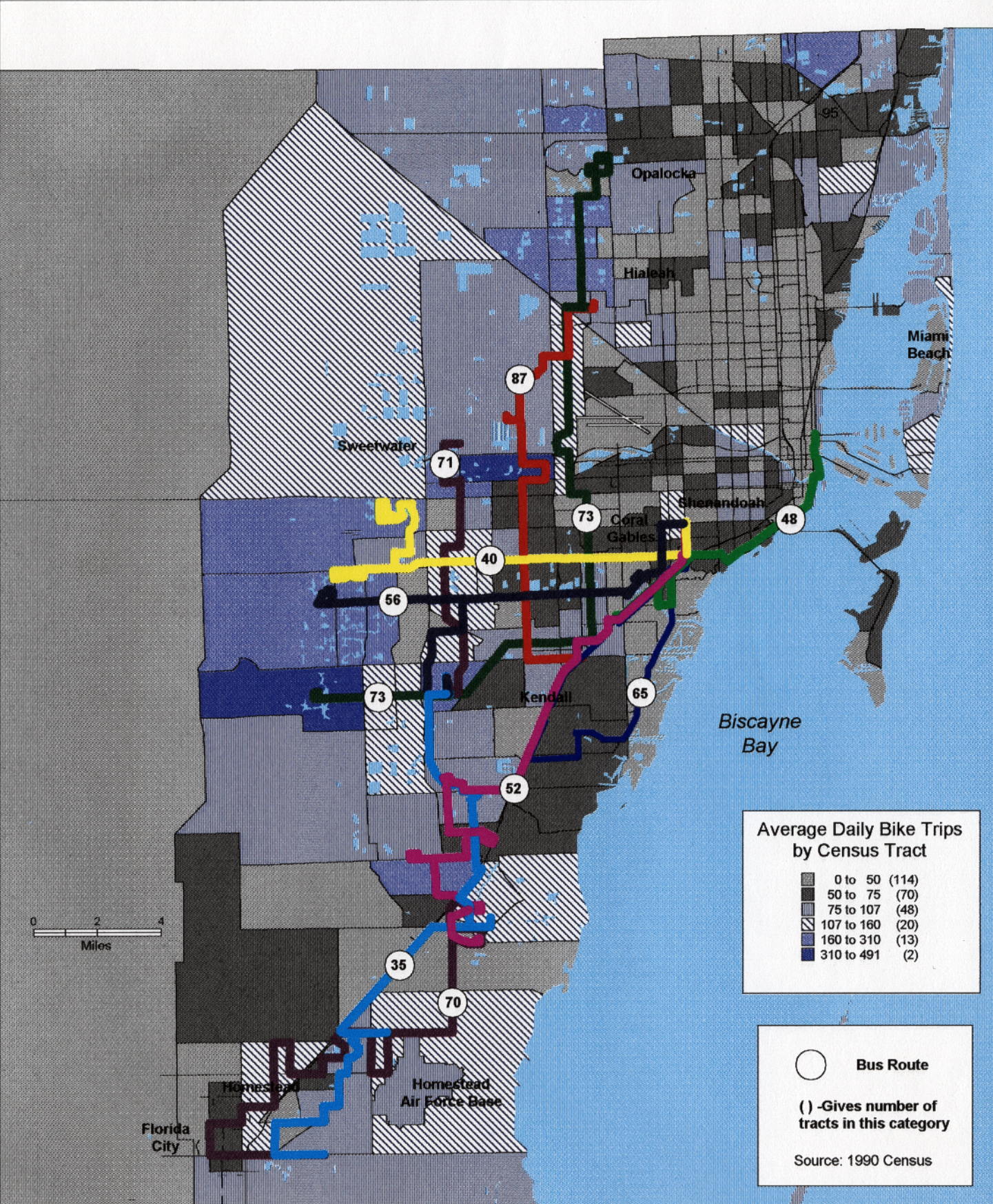

Figure 4

# Dade County, Florida

## Average Daily Bike Trips by Census Tract

(Bicyclists age 19-60+)







greater likelihood that they do not own an automobile and because they constitute a pool of individuals who are more likely to be physically able to ride a bicycle than those who are 60 years of age or older, or who have disabilities.<sup>17</sup> The 1996 projection for Dade County is 277,800 individuals in this category of transportation disadvantaged (TD) persons. In addition, there are many otherwise physically able elderly persons who do not drive automobiles. The number of low-income, non-disabled elderly persons was estimated at 45,468 in 1992 with an increase to 48,032 by 1996.

Transportation disadvantaged persons are eligible to receive governmental and social service agency subsidies for program trips and general trips. While some of these persons use demand responsive transportation service, this category represents a potential pool of prospects for riding fixed routes if they are not already doing so. While these persons are eligible for assistance, they may already be purchasing bus fare on their own. These persons may find bike-on-bus service highly useful.

Transportation disadvantaged persons tend to be generally located in Miami north of the downtown, in the south portion of Dade County near Homestead, and in the western fringe of urbanized Metro-Dade County. Those census tracts in shades of purple contain greater numbers of TD persons than those tracts in shades of gray. Those census tracts with the darkest shades of purple indicate the locations with the greatest numbers of TD persons. Ten census tracts indicate projected populations of between 2,870 and 4,030 TD persons. These include tracts located:

- in portions of Homestead and Florida City;
- west of U.S. 1 and south of Eureka Drive;
- north of U.S. 41 and west of S.R. 826 (Palmetto Expressway) in the vicinity of Florida International University;
- in portions of Miami Beach in the vicinity of 5th street;
- in Northwest Miami, west of U.S. 441 and south of N.W. 79th Street; and
- in portions of Hialeah, north of Okeechobee Road, west of 4th Avenue and south of Gratigny Pkwy;

The map also indicates that fringe areas to the west of the urbanized area also contain larger numbers of transportation disadvantaged persons. These areas are located east of S.R. 997 and south of U.S. 41.

---

<sup>17</sup> Transportation disadvantaged persons are defined in Chapter 427.011 F.S. as "...those persons who because of physical disability, income status, or age are unable to transport themselves or to purchase transportation and are, therefore, dependent upon others to obtain access to health care, employment, education, shopping, social activities, or other life-sustaining activities..." The estimations of TD persons used in developing the map are referred to as the Category I population, defined in the *Dade County Five-Year Transportation Disadvantaged Plan 1992-1996*, prepared by the Center for Urban Transportation Research in August, 1992. This definition has been adopted by the State TD Commission.

## **BIKE-ON-BUS SERVICE DEMAND BASED ON RESIDENTIAL LOCATIONS OF BICYCLE COMMUTERS**

Figure 2, entitled "People Biking to Work by Census Tract," was also derived from data collected in the 1990 Census. During the first week in April, 1990, one out of six households in Dade County received the long form survey containing questions pertaining to transportation mode for work trips. The question was stated:

"How did this person usually get to work last week? If this person usually used more than one method of transportation during the trip, pick the one used for most of the distance."

The total number of people, 16 years of age and older in the Miami urban area who selected bicycling as their principal method of transportation was 4,263. This is a comparable order of magnitude with the number of bicycling commuters in two other urban areas featured as bike-on-bus case studies in this report: Seattle, Washington and Portland, Oregon. Table 1 illustrates travel mode by urban area. Phoenix, Arizona has also been included as a case study because of some remarkable differences in mode share. Of the four urban areas, Phoenix has the highest dependence upon private vehicle travel and the lowest public bus ridership, but also the highest rate of bicycle commuting.

The actual numbers of workers who bicycled to work is listed in Appendix B by incorporated place, Census Designated Place (CDP) and by census tract. Figure 2 shows the locations of census tracts containing comparative numbers of bicyclists. Concentrations of commuting bicyclists are scattered across the map. Those tracts shown in patterns of purple shades contain more bicyclists than those tracts shown in patterns of gray. Fourteen census tracts contain between 56 and 161 workers who commute by bicycle. The darkest purple-shaded areas are located:

- in and around the Homestead Air Force Base;
- portions of Florida City and Homestead west of U.S. 1;
- in portions of Miami Beach in the vicinity of 5th Street;
- north of U.S. 41 and west of S.R. 826 (Palmetto Expressway) in the vicinity of Florida International University;
- in Southwest Miami, north of U.S. 1 and east of S.W. 27th Avenue;
- in Southwest Miami, south of U.S. 1 and west of S.W. 27th Avenue;
- in portions of Hialeah, north of Okeechobee Road, west of 4th Avenue and south of Gratigny Pkwy;
- in portions of Opa-Locka, south of S.R. 826 (Palmetto Expressway); and
- in portions of North Miami in the vicinity of W. Dixie Hwy.

**TABLE 1:  
Mode of Transportation to Work\*  
Urban Area Comparison**

<b>Mode</b>	<b>Portland, OR</b>	<b>Seattle, WA</b>	<b>Miami, FL</b>	<b>Phoenix, AZ</b>
<i><b>Car, truck, van</b></i>				
Drove alone	426,681	669,766	635,940	715,181
Carpooled	70,202	106,172	136,665	134,956
<i><b>Motorcycle</b></i>	2,039	3,041	1,383	7,146
<i><b>Public Transportation</b></i>				
Bus, Trolley Bus	35,254	73,370	42,951	19,588
Street Car, trolley car	1,427	169	340	43
Subway or elevated	363	151	6,320	75
Rail	599	40	1,155	41
Other	363	1,311	1,344	1,112
<i><b>Bicycle</b></i>	3,879	5,698	4,224	13,469
<i><b>Walk</b></i>	19,308	31,963	22,138	24,380
<i><b>Other</b></i>	3,054	5,300	8,492	6,701
<i><b>Worked at home</b></i>	19,309	30,335	17,597	26,989
<b>TOTAL</b>	<b>582,478</b>	<b>927,316</b>	<b>878,549</b>	<b>949,681</b>

\* Includes workers 16 years and older.

Source: 1990 Census of Population and Housing Summary Tape File 3C.

A comparison of Figures 1 and 2 indicate some general consistency among locations of low income people, and those locations with greater bicycle ridership for work commuting. These locations include the census tracts in the Homestead area and Florida City, those in the south part of Miami Beach, the area north of U.S. 41 and west of S.R. 826, locations in Opa Locka and North Miami and areas on the urban fringe in the western part of the County. However, those low income areas north of downtown Miami show less of a correspondence with bicycle commuting.

While Figure 1 illustrates the estimated number of people by residential location who are low income, Figure 2 illustrates the number of people by residential location who bicycled to work,

based upon data from the 1990 Census. The limitation of this data is that the U.S. Census provides travel information for the journey to work only, which accounts for approximately 21.6 percent of total trips by purpose.<sup>18</sup> The survey was also taken during one week only. The weather may have been unusually inclement or clear that week, altering the number of people who may ordinarily bicycle to work. Seasonal fluctuations in bicycle travel may not be reflected. Both the Portland, OR and Phoenix, AZ case studies experience seasonal fluctuations in the use of their bike-on-bus services. Only the primary mode of transportation is indicated; therefore, bicycle trips to access transit would not be included in these data.

### **BIKE-ON-BUS SERVICE DEMAND BASED ON DEMOGRAPHIC CHARACTERISTICS**

Another approach was then used to estimate bicycle trips by first using the Nationwide Personal Transportation Study, which provides data from which national average tripmaking characteristics can be estimated, then by applying these averages to U.S. Census demographic data at the census tract level.

In order to estimate the number of bicycle trips generating from specific Dade County census tracts, both the 1990 Nationwide Personal Transportation Study (NPTS) and the 1990 Census had to be used. The NPTS provides detailed information for all types of bicycle trips including demographic and socioeconomic characteristics. However, due to the sample size of the NPTS, it cannot provide any reasonable estimation of bicycling activity for specific Dade County census tracts. The 1990 Census provides information on the use of bicycles as a journey-to-work mode only. However, at the tract level the census provides a sufficient sample size for credible estimations. It was possible to use the 1990 NPTS and Census together to reasonably estimate the number of bicycle trips generated from Dade County census tracts.

From the 1990 NPTS, national averages for annual person trips by bicycle were calculated for specific demographic categories, namely gender by race by age. The number of persons representing these specific demographic categories was identified for each Dade County census tract using the 1990 Census-Summary Tape File 3A (STF3A). The total number of annual person trips by bicycle was calculated for each gender/race/age grouping by multiplying their estimated average annual person trips by bicycle by the number of persons belonging to each of those specific categories. The total for each census tract is simply the summation of the total bicycle trips from each demographic category.

The criteria for selecting the specific demographic categories was twofold. First, retaining consistency between the NPTS data set and the Census Summary Tape 3A was required. This excluded income as being a factor in this estimation. Between both the NPTS and the Census, income could not be combined with all the other demographic characteristics. Secondly, groupings were established in order to identify average annual bicycle trip factors greater than

---

<sup>18</sup> Nationwide Personal Transportation Study, 1990.

zero. However, this was not possible in all cases. For example, the average number of bicycle trips for nonwhite females ages 25 to 29 is zero. The demographic categories and their associated average annual bicycle trips are displayed in Table 2.

Nationally, white males age 18 and younger make more bicycle trips than any other group, with an average of 39.9 bicycle trips per year. The second and third highest tripmaking groups are non-white males, age 19 to 24 (20.9 annual bicycle trips) and age 25 to 29 (17.6 annual bicycle trips), respectively. As age increases, bicycle trip making generally decreases. This information reflects average trip making, which may under emphasize those persons who bicycle regularly for work or school commuting purposes.

The average annual bicycle trip generation for each census tract was then divided by 365 to calculate the average daily bicycle trips for each census tract. Appendix C contains "Bicycle Trip Generation, Dade County Census Tracts," sorted by census tract number and by order of highest to lowest estimated bicycle trips.

**TABLE 2:  
Average Annual Bicycle Trips by Demographic Category**

Demographic Categories/ Average Annual Bicycle Trips		Race	
		White	Other
Sex	Age		
Male	12 to 18	39.9	17.6
	19 to 24	13.9	20.9
	25 to 29	16.2	15.6
	30 to 39	8.7	5.6
	40 to 59	1.9	0.7
	60+	5.6	4.9
Female	12 to 18	10.7	2.7
	19 to 24	8.2	3.1
	25 to 29	5.1	0.0
	30 to 39	4.0	1.0
	40 to 59	1.9	0.0
	60+	0.5	0.0

Two significant strengths in the applied method exist. In this analysis, the best source of bicycling data available was used. Using both the NPTS and Census allows specific demographic categories to be established and a sufficient sample size from each Dade County census tract to be analyzed. Secondly, the applied methodology captures significant factors in bicycling use including age, race and gender.

Although the methodology applied was appropriate given the limited bicycling data available, three weaknesses are apparent. First, income is a significant factor that could not be captured in the analysis. Secondly, the methodology did not adjust the estimates for specific characteristics within the census tracts that may or may not encourage bicycling, such as the existence of bicycle lanes. Thirdly, the analysis did not account for the climatic and other geographical characteristics that encourage or discourage bicycling.

Figure 3 below, "Average Daily Bike Trips by Census Tract," for bicyclists age 12-60+ illustrates bicycle trips based upon demographic characteristics of the residents of Dade County. The information illustrated by this map is derived from the 1990 Nationwide Personal Transportation Study (NPTS), which accounts for all trip purposes and for all trip links by mode. Unlike the census data, which provides information specific to census tract location, the NPTS travel data represent nationwide averages that were applied to census tracts in Dade County using the method described above. The average number of daily bicycle trips totalled across all census tracts in Dade County, based on 1990 data, is 28,171.

Figure 3 shows that the census tracts indicating the most average daily bicycle trips are those located in the south end of the County and along the fringe of the urbanized area to the west.

The generally larger sizes of the census tracts to the south and the west parts of the county indicate approximately the same number of people as the other census tracts, but dispersed across larger land areas. This greater dispersion and distance from bus routes may indicate that these areas show higher potential need for a bike-on-bus service.

Because Table 2, "Average Annual Bicycle Trips by Demographic Category," indicates that the largest numbers of bicycle trips are made by white males age 18 and younger, the census tracts indicated in dark purple on Figure 3 are likely to be those containing larger concentrations of youth in this category. For example, Table 3 below shows the number of persons in each demographic category for Census Tract 010119. Those numbers multiplied by the average annual bicycle trip rates will likely result in census tracts containing large numbers of youth to be indicated in dark purple.

**TABLE 3:  
Number of Persons by Gender/Race/Age Category  
Census Tract 010119**

White males					
12 to 18	19 to 24	25 to 29	30 to 39	40 to 59	60+
1382	958	1120	2203	3081	1485
White females					
12 to 18	19 to 24	25 to 29	30 to 39	40 to 59	60+
1283	1110	1292	2712	3339	1954
Other males					
12 to 18	19 to 24	25 to 29	30 to 39	40 to 59	60+
91	174	222	299	281	94
Other females					
12 to 18	19 to 24	25 to 29	30 to 39	40 to 59	60+
99	104	167	320	367	82

One final map, Figure 4, indicating "Average Daily Bike Trips by Census Tract" for bicyclists age 19-60+ was generated, which shows an altered configuration of census tracts showing the most trips. The age group 19-60+ might represent a higher proportion of commute trips to work.

Comparing Figures 3 and 4, which differ only by the age range represented, it appears that more bicycle trips are still made generally in census tracts along the fringe areas to the south and west portions of Dade County.

**POLICY CONSIDERATIONS**

The analysis raises questions regarding a policy decision that should be considered by MDTA concerning selecting a target market. Nonmotorists are more likely to have lower household incomes than motorists.<sup>19</sup> Should the bike-on-bus service target lower income areas? Approximately 36 percent of non-motorized trips (bicycle and pedestrian) are for social and recreational purposes, while 27 percent is work

---

<sup>19</sup> Cathy Antonakos. "Non-Motorized Travel in the 1990 Nationwide Personal Transportation Study." Transportation Research Board. Paper No. 950569, Preprinted, January 22, 1995, p. 7.





or school related and 35 percent is for shopping and family business.<sup>20</sup> Should the bike-on-bus service target areas where it can be shown that a greater relative proportion of bicycle trips are made for work, school and business than for recreation? Should the bike-on-bus service be targeted to youth because younger age categories generate more bicycle trips? While demographic characteristics show nationwide that whites generally produce more bicycle trips than nonwhites, there are also greater numbers of whites in Dade County than nonwhites. Therefore, the areas of greater bicycle trip making shown in Figures 3 and 4 may be illustrating predominantly white populations. That more bicycle trips are made by whites, especially white males age 12-18, may be less an indication of the need to travel but more an indication of the ability to fulfill travel need. Conversely, nonwhites, especially nonwhite youths from low income families might refrain from desired trip making if they cannot afford bicycles. Similarly, females might reduce trip making due to fear of crime. As a result, care must be used in the interpretation of the data as an indication of travel demand. To some degree the analysis is constrained by the manner in which data was collected during the 1990 Census and NPTS. The inability to cross tabulate the data by income is one constraint.

How MDTA uses this information in the future should be based on careful consideration of the type of bike-on-bus service MDTA wants to provide and to whom it should be provided. This is especially true if the bike-on-bus service is not implemented systemwide but on certain selected routes.

However, for purposes of selecting three demonstration routes, this analysis does show where greater bicycling activity currently takes place and enables locational comparisons among suburban fringe areas, existing bus routes, and residential locations of transportation disadvantaged persons. Other considerations were included in the route selection as discussed in the next section, such as operational characteristics of the bus routes themselves.

Environmental factors, such as climate, roadway conditions and crime, may alter the actual number of bicycle trips. In the case of Dade County, climate and topography are favorable. The preparation of the *Dade County Bicycle Facilities Plan* indicates that planning is underway for the improvement of physical facilities. The existence of good facilities will encourage more bicycle trip making.

Demand for bike-on-bus service can be assumed to be greater for those bus routes serving specific trip destination types that attract greater numbers of bicyclists. Although the *ITE Trip Generation Manual* does not include bicycle trips in the vehicle trip counts conducted for various land uses to calculate trip generation rates, it can be reasoned that certain kinds of land uses may attract more bicycle trips than others, such as universities, large industrial sites and recreational areas. These types of locations would attract individuals who are likely to be lower income and/or youthful, such as students, factory workers and recreational bicyclists. This was the

---

<sup>20</sup> *Ibid.*, p. 20.

approach used in the selection of recommended routes for the bike-on-bus service discussed later in this report.

## **PHOENIX BIKE-ON-BUS TRIP MAKING**

The discussion above has described bus trip making characteristics and bicycling characteristics as they presently function separately in Dade County. The experience of other urban areas can indicate the effect of combining bicycle and bus transportation and the types of markets successfully served by bike-on-bus programs. Demographic characteristics of bike-on-bus users can be found from the Phoenix Bike-on-Bus Demonstration Program. Portland's Bikes on Tri-Met scheduled a user survey to take place in the Fall, 1994, the results of which are pending. The bike-on-bus program in Seattle plans an evaluation of their program next year.

Rider surveys conducted after the demonstration program in Phoenix indicated that ridership was predominantly male, with ages ranging from 13 to 66 years and an average age of 31. Approximately 90 percent of those surveyed identified themselves as commuters, the majority of whom were blue collar employees. A car was not available for half of those surveyed.<sup>21</sup>

The description of the magnitude and location of bicycling activity can offer some initial estimates of potential demand for the bike-on-bus service, but user surveys during the conduct of a program can also provide additional information about demand estimation.

This section has identified markets, based upon those most likely to desire and benefit from the service. Both market magnitude and location were addressed. It is concluded that a market does exist for a bike-on-bus service in Dade County.

## **DEMONSTRATION ROUTE SELECTION METHODOLOGY AND RESULTS**

An investigation of a bike-on-bus program for Dade County originally began in 1992. A committee was assigned to determine the requirements of such a program. The Short Range Intermodal Committee developed a method for determining which bus routes should be used to implement a bike-on-bus demonstration program. A review of this analysis confirms its soundness and applicability for selecting demonstration routes for a bike-on-bus program in Dade County. As a result, this analysis provides the groundwork for route selection. Application of the analysis narrows the selection of routes down to nine candidates. A description of the methodology is presented below.

The committee began the analysis by determining current route locations and the garage locations, where the buses are serviced. The MDTA currently operates buses on 69 routes in

---

<sup>21</sup> Phoenix Transit System, *Bike-on-Bus Demonstration Program* (September, 1991): 12.

Dade County. This includes two routes that have been added since the program investigation began. The three garages that service the MDTA buses are Northeast (NE), Central (CE) and Coral Way (CW). The number of vehicles required per route at the peak times ranges from 1 to 28 depending on the particular route and season.

An initial selection of route candidates was made based on the assumption that the demonstration buses should all originate from one garage, in order to reduce personnel training and equipment costs. Both bus operators and buses remain stationed at a particular garage. Those buses that were serviced by multiple garages and the buses that were operated by contractors were eliminated from the selection process.

There were 55 remaining routes that were then rated to determine which ones would service the largest number of areas where bike travel is prevalent. The trip characteristics that were considered to be advantageous to intermodal travel were selected and weighted. The routes were then scored according to this weighing system to determine which routes presented the greatest potential ridership demand.

There were six characteristics that were selected as having high potential for use of the bike-on-bus service. The selected characteristics include: 1) service to colleges or universities; 2) service to blue collar employment centers; 3) service to large regional recreation areas; 4) service to smaller recreation areas or shopping malls; 5) length of route, and; 6) connections to Metrorail. The connection with Metrorail was included due to the current Bike on Train program. The major centers of transportation related activity were taken from the 1992-1993 Dade County Congestion Management Plan. There have not been any significant changes to the number of activity centers since the original study began.

Each route was given a score for each of the six categories. The scores ranged from zero to two points depending upon the number of each characteristic that the route satisfied. Each of the six categories was weighted according to its importance to the success of the program. The score in each category was multiplied by the corresponding weighted number and the products were totaled for each route. The maximum score that a route could obtain was 5.0.

The category for service to a university or college was given a weight of 0.4. Other transit agencies have considered the access to universities to be very important to the success of their bike-on-bus programs due to inadequate parking facilities on campuses. While it was determined that college campuses in Dade County generally supply ample parking, access to large populations of low-income students make routes serving campuses attractive.

A bus line that served no college campuses earned a score of zero. If one campus was served it received a score of one. If the bus served two or more campuses, the route was given a score of two for that characteristic.

For the characteristic of service to blue collar employment centers the weight of 0.6 was given. This weight was selected because the Phoenix Bike-on-Bus Program demonstrated that a large

percentage of the customers were blue collar workers that used the **service** to commute to and from work. The scoring for this category was similar to that of the **universities**. If the bus line did not serve any of these centers it was given a score of zero. If it **served** one center a score of one was given and a score of two was given for service to two or more centers.

Large recreational areas were also given a high weight of 0.6 due to their likelihood of attracting bicyclists. The original intent was for this category to consider large recreation areas with poor or expensive parking. The areas that were found to fit in this category were primarily beaches and the Coconut Grove area. The score was set up in the same fashion as the previous categories. No points were given to routes that did not serve this type of area and one point was given if one area was served. If two or more areas were served then the route was given two points for that category.

The small recreational area category was given a weight of 0.3 and included such areas as regional and state parks, large shopping malls, and other notable attractions such as Parrot Jungle and the Homestead sports complex. The scoring in this category was slightly varied due to the large number of these areas that were identified. It was determined that there were over fifty areas that fit into the small recreational area category. A score of zero was given for one or no areas in this category. A score of one was assigned for two areas and a score of two was given for three or more areas that fit this description.

The category of long routes was also given a weighted value of 0.3. This category was included due to the results of the Phoenix study that the average bike-on-bus customer rides the bus for approximately forty minutes. This is a longer time period than that for other patrons. The route was given a score of zero if it extended less than thirty miles. A score of one was given to routes that covered between thirty and forty miles and the highest score of two was only given to routes that provided service for longer than forty miles.

The final category, which was assigned a weight of 0.3, considers route accessibility to the Metrorail stations. This was done to make the connections to the existing Bike on Train program. This program operates during non-peak hours on weekdays and at all times on weekends. There have been over 2,500 permits issued to cyclists for this program. The score of zero was assigned to routes that did not connect with Metrorail. If there was one connection, then one point was given, but for two or more connections a score of two was given.

The resulting scores for the 55 candidate routes are summarized in Table 4 below.

Next, any route that had a headway of fifteen minutes or less was dropped from consideration in order to minimize queuing of buses at the stops. (Routes with short headways recover less easily from delays.) The routes that were eliminated included: 9, 3, 27, and L. All of the routes that had a total score of less than two were excluded as well. The one exception was route 70, which was kept because it is interlined with another candidate route number 35. This process of elimination resulted in a short list of candidate routes included in Table 5.

**TABLE 4: Initial Route Selection Scores**

Route	Garage	Max	0.4 Univ.	0.6 Blue CoEmp	0.6 Big Rec	0.3 Small Rec	0.3 Long Route	0.3 Metro Rail	Total Points	CE	CW	NE
1	CW	9			2			2	1.8		1.8	
2	CE	8	1	1		2		1	1.9	1.9		
3	NE	12	1		2	2	2		2.8			2.8
7	CW	8		1		1		1	1.2		1.2	
8	CW	15	1		1	1		1	1.6		1.6	
9	NE	12	1	1	1	2	1		2.5			2.5
10	NE	6	1	1					1.0			1.0
11	CW	19	1	1					1.0		1.0	
12	CE	6		1	1			2	1.8	1.8		
16	NE	8				2			0.6			0.6
17	NE	11		1			2	2	1.8			1.8
21	CE	5	1	1	1			2	2.2	2.2		
22	NE	10		1	1	1	2	2	2.7			2.7
24	CW	11	1		1			1	1.3		1.3	
27	NE	13	1	1		1	1	2	2.2			2.2
28	NE	2	1	2				1	1.9			1.9
29	CE	2		2	1			1	2.1	2.1		
32	CE	10	2	2			2	2	3.2	3.2		
33	NE	6		2					1.2			1.2
35/70	CW	7	1	1	1		2		2.2		2.2	
36	CE	10		2				1	1.5	1.5		
37	CE	8		1	1	2	2	2	3.0	3.0		
38	CW	5					2	1	0.9		0.9	
40	CW	9	1		2	2	1	1	2.8		2.8	
42	CE	4		2	1	2	1	1	3.0	3.0		
48	CW	3	1		2	2		2	2.8		2.8	
52	CW	7	2		1	2	2	2	3.2		3.2	
56	CW	4	2		1	2	2	1	2.9		2.9	
54	CE	8		2	1		1	2	2.7	2.7		
57/72	CW	6			1		2		1.2		1.2	
62	CE	11		2	1			1	2.1	2.1		
65	CW	1			2	2		1	2.1		2.1	
71	CW	3	2	1	2	2	1	1	3.8		3.8	

**TABLE 4: Initial Route Selection Scores (cont'd.)**

73	CW	7	1	2	1	1	2	1	3.4		3.4	
75	NE	8	1		1				1.0			1.0
77	NE	16					1	1	0.6			0.6
83	NE	8	1	1	2		1		2.5			2.5
87	CW	6		2	2	2		2	3.6		3.6	
88	CW	7				1		1	0.6		0.6	
91	NE	3		1	1	1			1.5			1.5
104	CW	3										
B	CE	6			2	2		1	2.1	2.1		
C	CE	7				2			0.6	0.6		
E	NE	4	1	1	1	1	2		2.5			2.5
F/M	CE	6		1	1	1		2	2.1	2.1		
G	NE	9			1	1	1		1.2			1.2
H	NE	11		2	1	2			2.4			2.4
J	CE	11		2	1	1	2	2	3.3	3.3		
K	CE	12			2	2	2		2.4	2.4		
L	CE	23		2	2	1	1	2	3.6	3.6		
R	CE	2			1	1			0.9	0.9		
S	NE	28			2		2		1.8			1.8
T	CE	7			1	2			1.2	1.2		
V	NE	3			1	2	1		1.5			1.5
W	CE	2							0.0	0.0		
									SUM=	39.7	36.4	31.7

From the table of scores, one garage was selected with the best routes. This was accomplished by determining which garage had the highest score per route. While Central garage had the highest composite score of 28.2, its average score per route was 2.6. The average score per route for the Coral Way garage was 2.9; therefore, Coral Way was selected. The remaining nine candidate routes resulting from this analysis, include routes 35/70, 40, 48, 52, 56, 65, 71, 73 and 87. These nine route locations are depicted on the maps showing Census tracts, found earlier in this report.

Through further investigation, beyond the work of the Short Range Intermodal Committee, it was determined that while bus operators are assigned to specific routes and buses, approximately 25 percent of the drivers periodically change facilities at which they are stationed, during "line-ups." This means that cost efficiencies gained by conducting training at one garage may be mildly compromised by the necessity to periodically train newly assigned bus operators.

**TABLE 5: Second Round Route Selection Scores**

Route	Garage	Max	0.4 Univ.	0.6 Blue CoEmp	0.6 Big Rec	0.3 Small Rec	0.3 Long Route	0.3 Metro Rail	Total Points	CE	CW	NE
21	CE	5	1	1	1			2	2.2	2.2		
22	NE	10		1	1	1	2	2	2.7			2.7
29	CE	2		2	1			1	2.1	2.1		
32	CE	10	2	2			2	2	3.2	3.2		
35/70	CW	7	1	1	1		2		2.2		2.2	
37	CE	8		1	1	2	2	2	3.0	3.0		
40	CW	9	1		2	2	1	1	2.8		2.8	
42	CE	4		2	1	2	1	1	3.0	3.0		
48	CW	3	1		2	2		2	2.8		2.8	
52	CW	7	2		1	2	2	2	3.2		3.2	
56	CW	4	2		1	2	2	1	2.9		2.9	
54	CE	8		2	1		1	2	2.7	2.7		
62	CE	11		2	1			1	2.1	2.1		
65	CW	1			2	2		1	2.1		2.1	
71	CW	3	2	1	2	2	1	1	3.8		3.8	
73	CW	7	1	2	1	1	2	1	3.4		3.4	
83	NE	8	1	1	2		1		2.5			2.5
87	CW	6		2	2	2		2	3.6		3.6	
B	CE				2	2		1	2.1	2.1		
E	NE	4	1	1	1	1	2		2.5			2.5
F/M	CE	6		1	1	1		2	2.1	2.1		
H	NE	11		2	1	2			2.4			2.4
J	CE	12		2	1	1	2	2	3.3	3.3		
K	CE	12			2	2	2		2.4	2.4		
									SUM=	28.2	26.8	10.1
								Per Route Avg.		2.6	2.9	2.5

As a result, requiring all selected routes to be served from one garage, as a criterion, is rendered less applicable. It is possible that some very suitable routes may have initially been eliminated; however, this initial elimination process reduced the route candidates from a total of 69, down to 55 routes. This is a reduction of only 20 percent. Considering that the MPO requested a recommendation for just three bus routes to be selected for a demonstration program, a pool of 55 is more than sufficient from which to choose. The characteristics of many of the 55 route

candidates suggest a high degree of suitability for a demonstration program, which is favorable news if MDTA considers systemwide implementation in the future.

Furthermore, the nine routes selected from the analysis correspond well with locations of higher bicycling activity, as found in the estimation of bicycle trips by Census tract location.

It is recommended that MDTA select routes 35/70, 48 and 73.

**Route 35/70** operates from Cutler Ridge to Florida City Hall. This route serves the Metrozoo and Miami Dade Community College South Campus, as well as several industrial sites. Approximately 36 percent of the ridership is comprised of students. A person on a bicycle in the Homestead or the Florida City area could easily access route 35/70. These municipalities are the locations of many low-income persons.

**Route 48** serves three Metrorail stations, including the South Miami, University and Douglas Road stations. The route provides access to the University of Miami and the Bayshore Drive Bike Path. The route also provides access to downtown Miami and the Omni at its northern terminus.

**Route 73** operates from Miami Lakes Technical School to Dadeland North Metrorail Station, and serves Dadeland South and Okeechobee Metrorail Stations, as well as pockets of industrial sites in Medley and Miami Lakes.

Routes 35/70 and 73 were identified as serving a greater number of industrial sites.<sup>22</sup> In aggregate, the three recommended routes cover a broad portion of Dade County, connect with Metrorail and provide bus access to downtown Miami and to the fringe areas. As earlier studies have indicated, high potential demand for a bike-on-bus service occurs in areas known as the urban fringe, or suburban areas where bus stops are less frequent. Transit becomes particularly attractive where desired destinations are beyond ordinary bicycling distance from home, or more than five miles from the transit boarding point. The bike-on-bus service can be particularly beneficial to people who live too far to walk to the nearest transit boarding point, from 1/2 to 3 miles away.<sup>23</sup>

It is judged that routes 35/70, 48, and 73 also present the least number of complications that might interfere with testing the bike-on-bus concept. For example, one route was eliminated because it is contracted out to private companies on weekends. Another eliminated route has existing schedule adherence problems.

---

<sup>22</sup> MDTA, A. Smith. Memo to W. Fernandez. Bicycle Rack Score Description. January, 1993.

<sup>23</sup> Michael Replogle and Harriet Parcels. "Case Study No. 9: Linking Bicycle/Pedestrian Facilities with Transit." (October 1992): 90-91.



It is recognized that the selection of just three demonstration routes cannot connect with all the areas of Dade County where a bike-on-bus service would be desired and well utilized. The recommended demonstration routes have the best combination of advantages.

An area of high bicycling activity, as identified by recent FDOT bicycle counts, is the South Beach area of Miami Beach. However, bus routes to this area are served from the Central and Northeast garages only. In the future, routes serving the South Beach area of Miami Beach should be strongly considered if it is decided that the demonstration program should be expanded.

While the three recommended routes are judged from this study as the most suitable for the bike-on-bus demonstration program, the final selection for the top nine routes should be subject to amendment by MDTA to enable minimization of schedule adherence problems.



## **BIKES-ON-BUS EXPERIENCE IN AMERICAN CITIES**

The purpose of this chapter is to summarize the experience and lessons learned by other urban areas that provide bicycle transport aboard transit. Information gleaned from carefully selected case studies can provide insight to MDTA as they consider establishing their own bike-on-bus program.

An earlier discussion highlighted examples of urban communities across Florida that are establishing bike-on-bus programs; however, these are new programs and conclusions cannot yet be drawn from them. Also, none of these examples can be considered peer systems of MDTA. A look beyond Florida's borders is required.

An investigation of bike-on-bus programs across the nation identified close to thirty such programs in various stages of planning and implementation. Most bike-on-bus activity is associated with transit systems on the west coast, predominantly in California. Great variability was found to the degree in which programs were formally organized. For example, many agencies with years of experience allowing bicycles aboard transit--some since the 1970's--tended to take a laissez-faire approach to programming, while transit agencies embarking on new programs appeared intent upon creating formalized procedures for implementation, public outreach and evaluation.

### **CASE STUDY SELECTION**

The selection of case studies was based on several considerations. Criteria for the case studies included comparability based upon status as a performance review peer system.<sup>24</sup> Characteristics that were compared included number of employees, bus fleet size, multimodal characteristics, service area size and population. Case study candidates included Portland (Oregon), Dallas, Seattle, Santa Clara County California and Sacramento. Table 6, "Comparative Transit Data by Motorbus Mode," provides some first glance information about how the MDTA compares with other transit systems.

Identified programs were also categorized according to methods of bicycle transport: trailer, rear-mounted bicycle rack, front-mounted rack or in-vehicle transport. The vast majority of programs were found to use the front-mounted rack although some older programs initially started out with

---

<sup>24</sup> Information for this comparative analysis was obtained from the "Performance Evaluation of Florida Transit Systems" reports prepared yearly by the Center for Urban Transportation Research, College of Engineering, University of South Florida. These were prepared for the Florida Dept. of Transportation, using the federally-required Section 15 data representing years 1988 through 1992. A second source of information was from the Federal Transit Administration, USDOT, "Transit Profiles, Agencies in Urbanized Areas Exceeding 200,000 Population, For the 1992 Section 15 Report Year," (December 1993).

**TABLE 6:  
Comparative Transit Data By Motorbus Mode**

<i>Transit System</i>	<i>Service Area (sq. mile)</i>	<i>Service Area Population</i>	<i>Total Vehicles Operated in Maximum Service</i>	<i>Annual Unlinked Passenger Trips Per Directional Mile in Thousands.</i>	<i>Annual Passenger Miles Per Directional Mile in Thousands</i>	<i>Employees Per Vehicle Operated in Maximum Service</i>
Seattle - Metro Urbanized Area Transit Svc. Area	588 2128	1,744,086 1,482,800	911	23.7	158.0	2.83
Portland - Tri-Met Urbanized Area Transit Svc. Area	388 592	1,172,158 988,284	438	39.5	132.6	2.68
Miami - MDTA Urbanized Area Transit Svc. Area	353 285	1,914,660 1,735,000	505	38.2	161.7	3.34
Phoenix-Phoenix TS/ATC Urbanized Area Transit Svc. Area	741 416	2,006,239 996,166	274	20.1	88.5	3.24
Sacramento - RT Urbanized Area Transit Svc. Area	334 295	1,097,005 931,146	164	75.4	18.9	3.31
San Jose - SCCTD (Santa Clara County) Urbanized Area Transit Svc. Area	338 300	1,435,019 1,136,614	413	30.8	124.0	3.59

Sources: U.S. Department of Transportation. Table 25 and 26. 1992 Section 15 Annual Report. Federal Transit Administration, (December 1993).

U.S. Department of Transportation. "Transit Profiles the Thirty Largest Agencies." 1992 Section 15 Annual Report, Federal Transit Administration, (December 1993).

U.S. Department of Transportation. "Agencies in Urbanized Areas Exceeding 200,000 Population." 1992 Section 15 Annual Report, Federal Transit Administration, (December 1993).

U.S. Department of Transportation. "Agencies in Urbanized Areas with a Population of Less Than 200,000 Population," 1992 Section 15 Annual Report, Federal Transit Administration, (December 1993).

**TABLE 6:  
Comparative Transit Data By Motorbus Mode (cont'd.)**

<b>Other Florida Systems</b>						
<b>Transit System</b>	<b>Service Area (sq. mile)</b>	<b>Service Area Population</b>	<b>Total Vehicles Operated in Maximum Service</b>	<b>Annual Unlinked Passenger Trips Per Directional Mile in Thousands</b>	<b>Annual Passenger Miles Per Directional Mile in Thousands</b>	<b>Employees Per Vehicle Operated in Maximum Service</b>
Ft. Lauderdale - Bct Urbanized Area Transit Svc. Area	327 410	1,238,134 1,337,000	155	32.2	155.2	3.61
West Palm - Co Tran Urbanized Area Transit Svc. Area	307 555	794,848 775,335	60	6.2	39.5	2.63
Ft. Myers - Lee Tran Urbanized Area Transit Svc. Area	124 41	220,552 331,338	25	3.9	24.9	2.54
Tampa - Hartline Urbanized Area Transit Svc. Area	650 1,058	1,708,710 834,054	133	5.7	25.2	2.70
Tallahassee -TALTRAN Urbanized Area Transit Svc. Area	89 80	155,884 129,258	41	18.6	55.7	3.14
Gainesville - RTS Urbanized Area Transit Svc. Area	61 90	126,215 182,215	32	9.6	2.9	2.10

Sources: U.S. Department of Transportation. Table 25 and 26. 1992 Section 15 Annual Report. Federal Transit Administration, (December 1993).

U.S. Department of Transportation. "Transit Profiles the Thirty Largest Agencies." 1992 Section 15 Annual Report, Federal Transit Administration, (December 1993).

U.S. Department of Transportation. "Agencies in Urbanized Areas Exceeding 200,000 Population." 1992 Section 15 Annual Report, Federal Transit Administration, (December 1993).

U.S. Department of Transportation. "Agencies in Urbanized Areas with a Population of Less Than 200,000 Population," 1992 Section 15 Annual Report, Federal Transit Administration, (December 1993).

a bike-*in*-bus program or used rear-mounted racks. Most of the transit systems allowing bicycles inside the buses either cited low bicyclist demand or are now considering the use of exterior mounted bicycle racks. Trailers are used in only one or two locations, in response to special conditions. More about methods of transport will be discussed later in this report. Due to preferences expressed by MDTA, programs using bicycle racks received more emphasis in this study, although a search for successful bike-in-bus programs was also undertaken. Several locations use the bike-in-bus method, including Westchester County, NY, Santa Clara County, CA, the cities of Sacramento, San Diego, San Francisco, and Dallas and Pierce Transit in Washington State.

Other selection criteria have included identification of older programs, from which experience concerning operational issues and liability can be shared. Still other criteria included comparative ridership characteristics and the presence of special programs, such as transit personnel training and bus passenger education and permitting.

Those locations ultimately selected were:

**Seattle, Washington** because Seattle Metro has been a performance review peer. Theirs is one of the more experienced programs. An equipment acquisition process was recently completed and their program is well documented.

**Portland, Oregon** because Portland Tri-Met also has been a performance review peer, and their education and permitting, operator training, and evaluation is comprehensive and well documented.

**Phoenix, Arizona** because the Phoenix Transit System conducted a demonstration program in 1991, with an emphasis on monitoring and evaluation. This program is noteworthy because it has succeeded in attracting new ridership.

Selected aspects of programs in **Santa Clara County and Sacramento, California** are featured briefly to discuss the bike-in-bus option.

The first programs to be described are from **Hillsborough County and Broward County, Florida**, in order to include neighboring programs that share the same geography, climate and state political system. These are both very young programs; Hillsborough's HARTline has just completed systemwide implementation of a bike-on-bus program and Broward County is included in this study because it is Dade County's neighbor to the north.

Planning and transit staff representing the case study locations were interviewed on a range of topics, including details about demonstration programs and permanent programs, route selection for the bike-on-bus service, rationale for selecting their method of bicycle transport, information about operations, personnel training, public information, citizen participation, risk management, evaluation, program costs and funding and any other issues they believed were important to consider. A list of individuals contacted and an interview outline is included in Appendix D.

## HILLSBOROUGH COUNTY'S HARTLINE BIKE-ON-BUS SERVICE

The HARTline Bike-on-Bus Program planning proceeded with the Phoenix Bike-on-Bus Program serving as a role model. HARTline has assembled a Transit/Bicycle Task Force to provide input and recommendations to implement the program.

Initially, buses on routes serving the University of South Florida, Tampa Campus were rack-equipped. While the ridership is not yet being monitored formally, bus operators report that the racks currently mounted on two buses in the fleet are attracting approximately four riders per day.

The drivers are receiving some training using a video tape developed by the human resources department as part of an annual refresher course. The drivers initially had mixed responses to the program. The main concern was that they might have to load the bikes. The bicycles are to be loaded by the bicyclist only. The bicyclists are initially required to receive special training and permits to use the service. The Task Force recommended a permitting program for Bike-on-Bus patrons, putting the emphasis upon the safety and operational benefits gained from trained patrons despite the potential of discouraging riders due to the inconvenience of required training.

It was determined that through CMAQ funding the entire fleet of 170 buses could be equipped with front-mounted racks in order to prevent any difficulty for a bicyclist to transfer from one bus to another. The program features unlimited hours of operation. There was an initial rust problem with some of the rack parts, but the parts have been replaced with painted ones to prevent recurrence. The racks are made to accommodate any standard child or adult bicycle. The bus fare is the same for bicyclists as it is for other passengers. Bike lockers for the park and ride lots are being considered.

One of the goals of HARTline's Bike-on-Bus Program is to increase ridership for the transit system. The market that will be targeted to do this includes many individuals that might otherwise use a single occupancy vehicle. Some information will be distributed through home owner associations. School students and bike enthusiasts will also be targeted as potential patrons for this service. The transit dependent will also be informed about the new service that can potentially increase the transit coverage area. HARTline will disseminate information about the program through contact with local bicycle clubs and the Hillsborough Bicycle Advisory Committee, brochures distributed on the bus and at schedule kiosks and some possible television coverage. Customers calling the HARTline office can listen to a prerecorded telephone message describing the bike-on-bus service while waiting to be connected. A kick-off event was held in February, 1995, highlighting the new Bike-on-Bus Program in conjunction with the opening of a commuter center.

The brackets that are used to attach the rack to the bus depend on the type of bus that is used. Currently, HARTline operates RTS and FLEX buses. HARTline staff believe that there are some routes that may need to be modified due to narrow intersections that would disallow a bus with added length. HARTline buses currently in use are generally 96 inches wide and 40 feet long.

The bus maintenance cycle should not be affected by the racks. The racks can go through the bus washer and only the lock mechanism must be removed to access the front panel of the FLEX bus.

## **BROWARD COUNTY TRANSIT**

Broward County Transit is presently conducting a demonstration program of the use of bicycle racks mounted to the fronts of buses. Since the late 1980's, some Broward County staff have favored the idea of offering a bike-on-bus service. A primary concern has been acceptance of the bike-on-bus service concept by transit personnel. One way to help accomplish acceptance has been to involve transit staff in the testing of front-mounted rack equipment. For example, one rack from a selected manufacturer was purchased so that bus operators and maintenance personnel could test the ease of mounting the rack on the bus and the ease of loading and unloading bicycles. Bus operators could identify any problems, such as blind spots. In this way, the focus is on problem solving instead of resistance to the overall bike-on-bus concept.

Eliminating the rear-mounted rack option due to risk of theft, Broward planning staff and Broward County Transit bus operators evaluated several front-mounted racks, selecting one that they thought was the simplest to operate from the passenger's perspective. Another consideration was the ability of a passenger to load and unload a bicycle independently of other loaded bicycles. The concerns of bus operators focussed on any increased responsibilities due to the bike-on-bus service and the possibility of scheduling delay due to bicyclists unable to load and unload their bicycles in a timely manner. A need was identified for written procedures of operation and bus operator responsibilities.

The Broward demonstration program does not presently target specific markets nor specify program goals, though a main focus of the demonstration has so far been to select the best rack equipment. The first demonstration rack was purchased with Broward County general funds. The next ten racks were purchased through a state grant for the Broward Boulevard Corridor. It is estimated that \$250,000 will be required for systemwide implementation of bike-on-bus, including the purchase of racks for Broward County Transit's 200-bus fleet. The need for bicycle lockers at transfer stations was also identified.

There is no demonstration program time frame. One route was selected for the demonstration, Route 22, which serves downtown Ft. Lauderdale destinations as well as communities west of the downtown. Route 22 runs along a major arterial, Broward Boulevard, which connects the east and west communities in the county. All buses that serve Route 22, ten total, are equipped with bicycle racks. Buses run on 15-minute headways. The bike-on-bus service will be available at all times during regular bus service.

Staff were interested in applying the demonstration program to a route that would run from the east to the west part of the county. A route serving Oakland Park Blvd. (S.R. 816) was considered for the bike-on-bus service because it is a difficult road for bicyclists. However, staff



eliminated this route from consideration because it was felt that service at 30-minute headways was too infrequent to provide effective service to bicyclists in the event that the rack was full and a bicyclist had to wait for the next bus.

Bus route #22 was selected because, as an east/west route along Broward Blvd., it serves some lower-income neighborhoods that may be a market for the bike-on-bus service. It also serves recreational beach destinations at the east end. Because urban corridor funding was available for Broward Blvd., bus route #22 became eligible to use the funds for the bike-on-bus service.

No special age restrictions are placed upon bus passengers using the service. If the passenger is old enough to ride the bus on his own and he is strong enough to bicycle to the bus stop and load his bicycle onto the rack himself, then he may use the bike-on-bus service. Bus operators are not to load bicycles on the bus racks; this is to be done by the bicyclist only.

Broward County Transit's public information program about the bike-on-bus service will include brochures describing the entire program. They will be displayed wherever bus schedules are available, including the downtown terminal, the offices of Health and Rehabilitative Services, the courthouse, and offices for the issuance of driver licenses. Broward County Transit will prepare press releases. Information will also be included in the Route 22 bus schedule. The Downtown Ft. Lauderdale TMO will also promote the bike-on-bus service.

It is anticipated that bus passengers wanting to use the bike-on-bus service will not be required to undergo training and permitting. Staff see this as too large an obstacle for non-English speaking customers. The plan is for a pictograph placed on the front of the bus, demonstrating proper usage of the bicycle rack without words. Training for bus operators includes a video shown during in-service retraining, demonstrating proper interaction with bicyclists.

## **BIKE-ON-BUS PROGRAMS OF OTHER STATES**

While the bike-on-bus programs in Florida are useful to survey in order to help identify the issues, one of their limitations as case studies is that they are too young to show the results of program decision making.

The most informative case studies to help guide the development of a Metro-Dade demonstration program are from Phoenix, Seattle, and Portland, all three urban areas of which have at least a few years experience with implementing bike-on-bus programs and which offer the best documentation. The Phoenix program is known for its demonstration program evaluation. Portland Tri-Met has recent experience in the areas of customer information and permitting and Seattle Metro recently completed acquisition of bike-on-bus transport equipment after a careful vendor selection process. The case studies below highlight pertinent aspects of their experience.

## PHOENIX CASE STUDY

Differences in the agency organization that provides bus service to the Phoenix region, set it apart from other transit agencies. The City of Phoenix Public Transit Department and the Regional Public Transportation Authority closely coordinate efforts to provide bus transit service to Phoenix and the urbanized region. Known as the Phoenix Transit System to its customers, all operations, scheduling, maintenance, security, labor relations, demand-responsive service and marketing are conducted by private contractors.

At the recommendation of a citizen's committee, the Phoenix Transit System began a six-month bike-on-bus demonstration program in 1991, to test the approach as a means to improve ridership, address the region's worsening air quality and help transit serve an area characterized by low density development.

In some ways, this demonstration has served as a model for American bike-on-bus programs because of the emphasis that staff placed upon monitoring and evaluation of the demonstration program.<sup>25</sup> This was accomplished prior to the passage of ISTEA and the availability of CMAQ funds that have since provided a new impetus for the creation of new bike-on-bus programs nationwide. The Phoenix Bike-on-Bus Program was one of the first to develop, in-house, a more modern front-mounted bike rack design. Most worthy of note, *new* transit customers were attracted by the bike-on-bus service. The Phoenix bike-on-bus ridership is exceeded by no other program in the United States.

A sprawling land development pattern partly explains why Phoenix has both the highest proportion of automobile travel and the lowest proportion of public transportation travel, when compared to Portland (Oregon), Seattle and Miami. (Refer back to Table 1, Mode of Transportation to Work). Interestingly, Phoenix also has more than double the proportion of bicyclists to total commuters in comparison to the Portland, Seattle and Miami populations. These figures are from the 1990 Census and they demonstrate that bicycling was comparatively better utilized as a commute mode in Phoenix even prior to bicycle program improvements and the construction of bicycle facilities in recent years. The observation that many bus stops and many destinations are difficult to reach by walking, cycling or by transit may indicate how the bike-on-bus combination filled a strong transportation need in an urban area where residents have been more willing to bicycle despite the sprawl.<sup>26</sup>

---

<sup>25</sup> An Evaluation Report of the demonstration program was prepared by Phoenix Transit System staff with the participation of the Bicycles on Buses Citizen Task Force: Phoenix Transit System, *Bike-on-Bus Demonstration Program* (September 1991).

<sup>26</sup> Lisa Wormser, ed., "Phoenix Matches Modes; Region's Bicyclists Get Parking To Go," *STPP Resource Guide, Case Studies*, Surface Transportation Policy Project: Washington, D.C., 1992.

## Demonstration Planning

Three regular bus routes were selected for the demonstration, based upon access to bikeways, regional shopping malls, the Scottsdale and Tempe downtowns, the state university and several transit transfer points. All three routes intersect to allow for transfers. Route length (one-way) for the three routes ranged from 19 to 35 miles and service for all routes ran on 20 to 30-minute frequencies. Monthly bike/bus boardings increased steadily from 153 at the end of the first month to 1,404 at the end of the last month of the demonstration, which was held during the season of traditionally low bicycling activity. The route of highest ridership was that serving the university and the Scottsdale and Tempe downtowns. Because the demonstration exceeded ridership expectations, the program was implemented permanently systemwide. Presently, bike/bus boardings average over 1,000 *daily*.<sup>27</sup> Many bike-on-bus passengers that were surveyed indicated that they do not have a car. Some users would not have made the trip at all prior to the bike-on-bus service. Close to 90 percent of those surveyed described their bike-on-bus trips as commute trips.

Funding for the demonstration program came from the state department of transportation air quality demonstration program fund. A \$10,000 grant paid for development and installation of the racks. Program administration and operations came from the city. Ultimately included in the metropolitan planning organization TIP, federal transit funds and a local match financed the program beyond the demonstration. Costs covering in-house manufacture and maintenance of 47 bicycle racks and marketing of the demonstration program for the six-month period totalled \$17,655. Personnel training and staff time required to plan and oversee the program was not included.

During the demonstration program, 47 buses serving the three selected routes were equipped with bicycle racks that were manufactured in-house. The citizen's committee originally considered allowing patrons to bring bicycles inside the buses, but rejected the idea based upon concerns and untested assumptions that such an allowance would cause safety problems and schedule delays.<sup>28</sup> It was also believed that bicycles inside the buses would occupy room needed for passengers, hindering efforts to increase ridership.

Front-mounted racks were elected over the use of the rear-mounted racks, because greater visibility and less interference with bus maintenance hatch access could be achieved with racks mounted to the front of the buses than to the back. Until the late 1980's, a prong-style bicycle rack for use on a bus had been used in other urban areas. In response to concerns with perceived safety and damage risks caused by the extended metal brackets upon which the bicycles are placed on a prong-style rack, the transit staff in Phoenix developed a front-mounted rack that could accommodate two bicycles, using a tray system in which bicycles rest within a wheel well

---

<sup>27</sup> Mike Nevarez, Transit Operations Manager, City of Phoenix Public Transit Department, personal interview, November 15, 1994.

<sup>28</sup> A test of the feasibility of bike-in-bus was conducted for one day only.

or slot. During the demonstration program, performance and durability of the racks were closely monitored. As problems arose and were documented, alterations and improvements to the rack design were made.

### **Demonstration Evaluation**

Planning staff evaluated the demonstration program, with particular emphasis upon knowing customer opinions about service usefulness and quality and upon knowing bus operator concerns about safety and operational efficiency. Information was compiled in order to determine program effectiveness, then later to establish a permanent bike-on-bus program.

At the request of the Phoenix City Council, a report was provided halfway through the demonstration program. Over the duration of the demonstration program, bike/bus ridership was counted by bus operators. Bus operators assigned to the three demonstration routes also voluntarily completed Operator Evaluation Forms at the end of the six-month demonstration. The forms contained questions pertaining to the time it takes for passengers to load and unload bicycles, passenger conduct and rack performance.

Survey cards were distributed on the bus and telephone surveys were conducted of both regular passengers and bike/bus passengers at the end of the fifth month of the demonstration project.

A total of 130 bike rider survey cards were completed and returned. Questions were asked about:

- frequency of bus tripmaking with and without a bicycle;
- trip purpose during bike-on-bus service use;
- route preference for bike-on-bus service;
- location of bike/bus boarding and exiting;
- travel direction; and
- an open-ended request for any comments.

Those surveyed riders who also provided a telephone number were contacted again. Over forty bicycle rack users were interviewed by phone. They were asked:

- how they learned of the bike-on-bus service;
- whether they were new bus patrons because of the bike-on-bus service;
- car availability and travel mode prior to the bike-on-bus service;
- trip duration on the bus as well as the duration of the bicycle trips to the bus stop, then to the final destination;
- bicycle characteristics and loading/unloading times;
- travel time of day, age, gender and employment type; and
- whether problems were experienced with the racks.

A total of 112 general survey cards were received from bus passengers who were not using the racks at the time of the survey. The survey contained questions including:

- total bus ridership frequency;
- degree of passenger understanding of bike rack operation;
- previous bike rack use and trip purpose;
- route preferences for the bike-on-bus service; and
- perceptions regarding bike-on-bus service necessity, quality and schedule delay

A follow-up phone survey of over twenty bus passengers was conducted, which was an abbreviated version of the phone survey of the bike rack users.

No incidents involving injury or major damage have occurred to the bicycles, buses, personnel or customers since the beginning of the bike-on-bus service. One theft was reported, but it was the result of the bicyclist not communicating to the bus operator that he needed to unload his bicycle after exiting. The bus operator drove away and another passenger stole the bicycle.

## **PORTLAND'S BIKES ON TRI-MET PROGRAM**

The Tri-County Metropolitan Transportation District (Tri-Met), located in the Portland urbanized area of Oregon, operates a bike-on-bus program that was selected for case study review because it has one of the most well-established programs in the nation and because some operational characteristics are similar to those of the Metro-Dade Transit Agency.<sup>29</sup>

A general theme of the Bikes on Tri-Met program has been responsiveness to customers and providing service. The Bikes on Tri-Met program has broadly defined target markets, including commuting workers, low income citizens, students and bicycle enthusiasts. A program goal is to see a positive trend in bike-on-bus ridership. Bikes on Tri-Met service is available during all days and hours of transit service, including the evening hours.

### **Demonstration Planning**

The program was begun at the urging of the Bicycle Transportation Alliance, a local group of citizen bicycle advocates. Program start-up began with an internal Tri-Met team of representatives from different departments, such as legal affairs, fare inspection and the transit

---

<sup>29</sup> The case study of the Bikes on Tri-Met Program of Portland, Oregon was assembled from discussions with Richard L. Gerhart, P.E., Tri-Met Director of Operations Planning and Scheduling on September 7, 1994, and Steve Gillmer, Tri-Met Customer Service Specialist on September 8, 1994. Information was also obtained from training materials, brochures and administrative forms prepared by Tri-Met.

police, who initially met as a group for planning coordination workshops. They now meet one-on-one with the program manager as the need arises.

Demonstration program objectives were originally broadly defined. Tri-Met expected to test the operational feasibility of the Bikes on Tri-Met program and over the course of the one-year demonstration program, to see a positive trend in the use of the service. A twelve-month time frame was selected for the demonstration program in order to provide sufficient time to allow for program modifications and to collect information on seasonality.

Tri-Met has a bus fleet size comparable to that of the Metro-Dade Transit Agency. Approximately 430 buses that are used include the Flexible, Gillig, GMC and the RTS. Both the GMC and the RTS buses will be retired soon. Tri-Met employs approximately 1100 employees of which 25% are part time.

The Bikes on Tri-Met Program began in July, 1992 with enough funds for a demonstration program to purchase 79 front-mounted demonstration racks for \$414 each. After the decision was made to equip all buses with racks, then 350 racks were purchased for \$300 each. The entire Tri-Met fleet was scheduled to be rack equipped by September 1994.

Tri-Met used operational funds to purchase the first 79 racks. After the demonstration program showed signs of success, CMAQ funding was applied for and granted, but the funds were never used due to timing problems and confusion of roles among multiple agencies in the administration of the funds.

The initial rack purchase accommodated eight out of a total of what were then 75 bus routes. Through the use of a customer survey and the input of the Bicycle Transportation Alliance, the routes were selected for their geographic coverage, including crosstown, radial and trunkline routes, in addition to long distance routes and those that served recreational areas.

### **Front-Mounted Rack Design**

Tri-Met uses a front-mounted rack modified from a Yakima car rooftop rack. The modifications were made in-house by a transit agency mechanic who developed a special mounting bracket and frame. The racks are lightweight and easy enough for one person to install and remove. The bicycles are secured by a clamp unit with velcro straps. In the future, the velcro straps will be augmented with a plastic snap, in case the velcro does not last under rainy conditions. Moving parts will require periodic lubrication in the future. Reflective tape placed on the rack indicates proper location of the front wheel.

A fully loaded front-mounted rack was not found to obstruct the headlight stream, according to a periodic inspection by the State Public Utilities Commission. Small convex mirrors have been added to the left front corners of the buses to provide a better view of the front.

The rack can remain on the bus during the wash cycle, with no damage to the wash bristles. This is an important convenience when compared with the time and effort that would be required to remove the racks from 600 buses, then reinstall them after each wash.

Bus operators have not reported problems with making right turns while the racks are unfolded. Some intersection approaches are painted with staggered stop bars to allow extra clearance. However, the emphasis of the Tri-Met program is upon training. It has been found that one hour of bus operation with the racks attached to the buses allows the operators sufficient time to become used to any alterations necessary for safe turning.

While bus stop design was considered adequate for purposes of the Bikes on Tri-Met program, roadway access to the bus stops was identified as a significant problem for bicyclists. A general lack of bicycle lanes on the existing street system makes accessing the Bikes on Tri-Met service difficult.

As long as the passenger is loading a bicycle onto a bicycle rack, the bus operator must keep the doors of the bus open. This is to ensure that the interlock system of the bus remains engaged and that the bus will not accidentally roll.

Bicycles are loaded into the outside slot of the bicycle rack first to help the driver perceive the outer limit of the rack and to reduce the vibration of the rack apparatus.

### **Bikes-on-MAX Program**

Similar to MDTA's Bike-on-Rail Program, Portland also has a Bike-on-MAX program. Portland's MAX train runs between Portland and Gresham, a distance of roughly 17 miles. Passengers may transport their bicycles on MAX at any time except during snow and ice conditions and during the peak time in the peak direction of travel on weekdays. This means that Bikes-on-MAX are disallowed from 6-9 a.m. to Portland and from 3-6 p.m. to Gresham. The MAX trains experience very crowded conditions during the weekday peak hours. Bicyclists may transport their bicycles on MAX at any time during the weekend, even when it is crowded. Bicycles may enter the train only through designated doors. Because of the popularity of the Bikes-on-MAX service, Tri-Met is looking at ways to allow longer service hours.

There is allowable space for six bicycles on a two-car train and for two bicycles on a one-car train. Bicyclists are instructed to allow all other passengers to enter or exit MAX before boarding with the bicycle. Bicyclists are instructed to enter MAX either through the end doors of the second car or the rear door of the first car. Bicycles are to be placed against the driver's cab wall at the end of the car or at one of the two wheelchair tie-down locations with the seats folded up. Bicyclists are to remain standing the whole time while holding onto their bicycles. If all bicycle spaces are in use, then the bicyclist must wait for the next MAX train.

There have been many requests from bicyclists to be able to sit down while riding MAX with their bicycles aboard. The bicycles can be secured by the wheelchair clamp. Some bicyclists use bungee cords for added security. The wheelchair clamp works well for stopping forward/backward motion but not for lateral motion. Those bicycles that are positioned against the cab wall are not secured.

### **Staff Time Requirements**

The planning, start-up and ongoing administration of the Bikes on Tri-Met program has required the time of management, training and marketing personnel. While records of time requirements were not kept, the program manager estimated that the Bikes on Tri-Met program has required approximately 10-15 percent of his time. Now that the elements of program start-up are becoming an established routine, this time requirement is decreasing.

Other elements of the program have become new responsibilities of existing customer service personnel, such as administration of the permitting program. Many tasks are natural extensions of existing responsibilities. For example, the marketing department provides a free computerized ride matching service. A natural extension to their duties includes the Bicycle Buddy program, recently created to pair novice bicyclists with experienced bicyclists for the trip to the bus stop. Tri-Met receives applications from interested customers, then sends a list of names and phone numbers so that the customer may initiate the contact.

### **Bus Operator Training and Participation**

The attitudes of the Tri-Met bus operators about the bike-on-bus service range from strident opposition to ardent support. Some bus operators are serious bicyclists themselves; therefore, they have tended to be the ones who helped champion the concept and have supported demonstration efforts and testing.

Bus operator training for the Bikes on Tri-Met program consists of one hour of classroom instruction, including a video presentation, and one hour of on-road practice in which they demonstrate their knowledge. This training is administered as a refresher program for existing bus operators and as part of initial training for newly hired operators. There are no specially written standard operating procedures for bus operation in relation to bicycle transport aboard the buses. The training is conducted in groups of five or six bus operators.

Bus operators are permitted to aid bicyclists in the use of the rack but they are not required.

The biggest challenge is to keep the customer information representatives up-to-date on the latest increase in Bikes on Tri-Met service, in which new routes have been gradually added.



## **Safety, Security and Liability**

The demonstration program was designed conservatively due to the fear that a single incident might eliminate support for the entire program.

Tri-Met is self-insured and treats liability for the bicycle the same as any other possession. There have been four incidents since the Bikes on Tri-Met program began over two years ago. Each incident involved a bicycle coming off the rack. One individual asked to be reimbursed for the cost of needed bicycle repairs, which Tri-Met provided. Since establishing Bikes on Tri-Met, insurance rates have not increased.

Equipment inspection conducted every 1,500 to 2,000 miles includes testing that the rack is operational and that the bicycle fasteners are secure.

While there is no rack lock mechanism to prevent bicycles from being stolen from the racks, no incidents of theft have been reported. One bicyclist expressed concern that he could not see his bicycle from the back seats of the bus, which were usually the only seats available at the time he boarded. In a case such as this, the answer is for the bicyclist to develop communication with the bus operator about his concerns. Over the course of the program, one bicyclist has forgotten to retrieve his bicycle from the bus when he disembarked. The bicycle was taken to the lost and found office, where its owner retrieved it the next day.

Tri-Met's legal department maintains that the waiver of liability form provides no legal protection whatsoever and should be eliminated. It is believed that it actually invites litigation by generating the idea for potential litigants. Consideration is being given to the possibility of completely doing away with the permitting process and the waiver of liability in the future.

Bicycle parking provided at Park-and-Ride lots was not well used due to fears of vandalism. In response, secure bicycle lockers have been installed. The City of Portland handles all transactions and program administration of bicycle locker rental at bus stops, which were provided prior to the Bikes on Tri-Met program. The lockers can be rented for \$7.50 per month, with a \$15 refundable key deposit. Tri-Met purchases and maintains the lockers at two transit centers, two park-and-ride lots and at seven MAX light rail stations.

Tri-Met established a permitting program to ensure safety. Persons 16 years and older may obtain a regular permit, which can be used on both the buses and the MAX train. The bicycle patrons fill out a permit application, sign a liability waiver, watch a short video produced by Tri-Met's in-house training department, pay \$5.00 and demonstrate that they can load and unload their bicycle from the bicycle rack, after practice using a test rack. Applicants receive a wallet-sized permit that is good for two years. The back of the permit lists the program rules. A permit must be purchased in person and it is not transferable for use by another person. Current permits are good until June 30, 1995, when new 2-year permits will be issued. Permits will be reissued in June 1995, but at the time of the interview, no plans were made for reissuance procedures.

A youth permit may be issued to those ages 8 to 15. A parent or legal guardian must sign a waiver of liability form before the permit is issued. Youths must be accompanied on the train by an adult 18 years or older who also has a permit. The permit is only for the bicycle. The passenger must still pay the regular fare.

The permitting is conducted at two Tri-Met offices, including Tri-Met's Transit Store, located centrally in the downtown, in addition to six participating bicycle shops. Tri-Met provides the shops with a sales kit, a demonstration bicycle rack and a video that explains rules and demonstrates operating procedures. The shops provide the VCR and monitor. The shops administer the permitting



*Several bicycle retailers in Portland volunteer to provide training and sell permits for the Bikes on Tri-Met Program.*

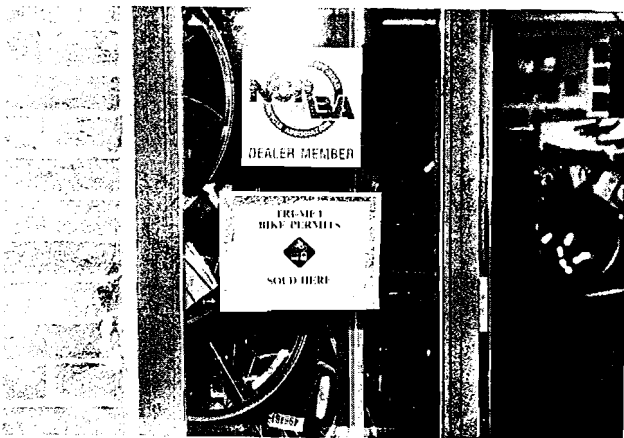

*This Portland bicycle shop manager supervises training on a demonstration bicycle rack.*

program as volunteers, recognizing that the additional customer traffic into their shops helps their businesses.

Fare inspectors receive training about the bike-on-bus service. Tri-Met has had to confiscate a very small number of permits due to rule violations. The violations are largely committed by a few young individuals who are repeat offenders. However, almost all rule violations occur on the MAX light rail line. Usually, the offense is either an invalid permit or riding MAX during

the peak period in the peak direction, which is prohibited by Tri-Met. Tri-Met issues a warning for the first offense, then a citation for the second offense. The third time that the violation is committed, Tri-Met fare inspectors issue an exclusion, in which the violator's permit is confiscated for one month. During the last fiscal year, Tri-Met has issued only one exclusion.

It is not known whether the permitting program has diminished Bikes on Tri-Met ridership. Presently, permits are sold at a rate of about 150 per month. Bike-on-bus ridership is an increasing trend but this is partly because Tri-Met has been continuing to equip more buses with racks. After one additional cycle of requiring a 2-year permit, during which a positive safety record is maintained, it is believed that the permitting program may be discontinued. The permitting program was considered necessary to the initial start-up of the service, to ensure safety, maintain schedule adherence and reduce liability, while Tri-Met could observe how the program functioned and make necessary alterations. In the future, as more Tri-Met passengers decide to use the service, allowing other riders to observe and grow accustomed to the procedures, training will gradually become unnecessary. It is expected that learning to use Bikes on Tri-Met service will be a matter of course, similar to learning to read a bus schedule.

### **Performance Evaluation**

Demonstration program evaluation has included a survey of Bikes on Tri-Met permit holders and a survey of Tri-Met bus operators and supervisors. Approximately 20 percent of the bus operators perceive that Bikes on Tri-Met has affected schedule adherence. With the exception of one or two isolated instances, the program has not caused systemic delay, as verified by Tri-Met's regular traffic checking program to monitor on-time performance.

Evaluation is conducted by monthly reports that show Bikes on Tri-Met ridership tends to fluctuate with the seasons, with a high of 1000 bicyclists during the month of September, 1993 to a low of about 700 bicyclists during the month of February, 1994.

An origin-destination survey was scheduled to be conducted in the Fall of 1994. The survey will allow determination of a user profile. The survey will also indicate if Bikes on Tri-Met has altered ridership patterns, such as reducing the need to transfer. It is too early to determine the success of the Bicycle Buddy program, since it is a recent service addition.

While customer and operator complaints are initially recorded on a computerized form and routed to the appropriate department, they are usually resolved by the program manager.

Portland's demonstration program took place in 1993. During their second year of operations, the FY 1994 fare results showed a doubling of the number of permits sold and the number of bikes on buses.

### *FY 1994 Fare Results*

Permits sold:	2,758
Bikes-on-buses:	14,300
Bikes-on-MAX:	26,500

It is too soon to tell which routes operate most successfully for the Bikes on Tri-Met program, considering that some routes have had service longer than others. It is felt that those bus routes with the heaviest ridership (mostly long distance trunk lines all of which start in the rural areas and suburbs and lead to the downtown) will tend to exhibit highest Bikes on Tri-Met ridership.

### **Bike-in-Bus Transport Method Reconsidered**

Some Tri-Met bus routes are already experiencing capacity problems, particularly in cases where families of greater than two individuals want to board with their bicycles. Tri-Met is presently studying alternatives to allow more than two bicycles on the bus. Tri-Met is continuing to work with citizen committees representing the concerns of the elderly and handicapped, pursuing the feasibility of the bike-*in*-bus option in conjunction with the use of low floor buses.

The bike-*in*-bus method of transport was initially considered. However, after opposition was voiced by the elderly and customers with disabilities, the bike-*on*-bus method was selected.

In the Fall of 1997, Tri-Met will acquire low-floor light rail vehicles as part of the Westside Light Rail Project. The vehicles have no steps but rather a slight ramp. Tri-Met is working closely with the Committee on Accessible Transportation (COAT), which has agreed to try allowing bicyclists to use the designated wheelchair area of the low-floor buses, as part of the demonstration project.

### **Public Information**

As part of marketing efforts, Tri-Met held a Bike Transit Fair at Pioneer Square, a public park located centrally in the downtown. Bike-on-bus demonstrations were held, featuring one of their newly acquired clean air LNG buses. The media covered the event.

Bikes-on-Tri-Met also offers a phone information line that explains how to use the bicycle racks on the buses and how to transport a bicycle aboard the MAX train. It is a menu of recorded messages offering information on the following topics:

- How to apply for a bike-on-bus permit
- A regularly updated list of bicycle accessible bus routes
- Procedures for Bike-on-MAX

- How to rent a bicycle locker and information about the Bicycle Buddy computer matching service
- Special bicycle permits for persons with disabilities
- All other information

## **SEATTLE METRO BIKE-ON-BUS SERVICE**

What makes the Seattle Metro case study interesting and different is the manner in which they selected their bike racks and made sure that they received an acceptable product.

The Seattle Metro's Bike-on-Bus Program actually got its start more than ten years ago as a service along a few selected routes that used bridges serving State Route 520 and I-90, where bicycle access was prohibited. Prior to a bike-*in*-bus demonstration and the decision to acquire and equip the entire bus fleet with new bicycle racks, there were as many as ten routes equipped with older style front-mounted bicycle racks serving the Eastside, in addition to routes running between Seattle and Bellevue. Some routes served weekday trips only, other routes also served weekend and holiday travel, and still others served Saturday trips only. Not all trips were served with buses equipped with bike racks; therefore, riders had to consult timetables. This original service provided for bus stops that were designated bicycle loading and unloading stops; bus stops not designated as bicycle loading points prohibited bicycle loading. Designated stops featured green Bike & Ride decals on the bus signs. This original service did not require permitting. Bicyclists paid the same fare as other passengers.

Metro had several years ago tried the rear-mounted bicycle racks but quickly decided against their use because the bus operators could not see activity behind the bus. The Cascade Bicycle Club designed and built the original front-mounted bicycle racks. These were of the style that included arms or prongs upon which the bicycles were hung. This type of rack had to be removed each time the bus was washed. The old racks carried a maximum of two bicycles. A third bicyclist would have to wait for the next bus in order to board with his bicycle. Bicycles were not permitted inside the bus.

Because bicycling is popular in the Seattle community, the bicycling community was perceived as a market for bus ridership. The motivation for providing the bikes-on-bus service was to improve customer service.<sup>30</sup> The guiding principles for this service are to implement the program as simply as possible, and to provide a service that is easy for the customers to use, with as few restrictions as possible. Metro's demonstration program was not so much to decide whether to offer a bikes-on-bus service--Seattle had already been doing this for over ten years--but rather to test the bike-in-bus method, then later to test three different types of front-mounted racks.

---

<sup>30</sup> Information about the most recent efforts of Seattle Metro to establish a bike-on-bus service, was received through interviews with Peggy Renfrow of Operations, and Dave Lilly, Supervisor of East Base Vehicle Maintenance, King County Department of Metropolitan Services, Transit Department.

Metro is a joint agency with a water quality department. Because of the relationship between water quality and atmospheric deposition caused by automobile exhaust, Metro is interested in projects that will reduce emissions, including bike-on-bus service. Metro applied for an amendment to the Regional Transportation Improvement Program (TIP) to include the bike-on-bus project to improve bicycle/transit travel. This application was for a federal CMAQ grant, totalling \$950,000 in funds, to combine with a local match from Metro of \$237,500 in order to develop new transportation capacity, increase bicycle use in the region, and improve air quality. An approved grant application enabled systemwide bikes-on-bus implementation, scheduled for November 1, 1994. It was estimated that with systemwide implementation, up to 2,400 bike/bus daily boardings could be achieved.<sup>31</sup>

To plan the Bike-on-Bus program, a task force of twenty individuals was assembled. These included representatives from such departments as operations, safety, scheduling, service development, vehicle maintenance, training, and market development. Subcommittees were established to investigate identified issues. At various stages of program planning, participants included both full-time and part-time bus operators, sheet metal workers, mechanical engineers, buyers, and also representatives of the public, including private citizens, bicycle club members, and members of King County Roadshare, a citizens group that works toward improving pedestrian access.

### **Bike-in-Bus Pilot Test**

Before deciding ultimately to stay with the front-mounted rack method of bicycle transport, Metro conducted, at the request of the Seattle City Council, a bikes-*in*-bus pilot project for a period of one month, during four consecutive weekends in the Spring of 1993.

The Metro Bicycle Task Force devised the guidelines for the pilot program. During this time 246 bicycles were transported. Bus operators were given the discretion of turning away bicyclists if space was too limited or if hazards were perceived. Operators were to advise the cyclists where to store the bicycle within the bus and to try to allow at least two cyclists aboard. The cyclist would board the bus by either the front or the rear door at the request of the bus operator. The cyclist had to be able to board and deboard without bus operator assistance. After initial consideration that the cyclist should pay more for bringing a bicycle inside the bus, it was decided that the cyclist would pay the normal fare.

A survey of 1,200 bus passengers conducted by Metro Council indicated that 44 percent of the respondents indicated that bicycles should not be permitted inside the buses. Another 31 percent of the respondents indicated that bicycles should be permitted inside the buses during off-peak

---

<sup>31</sup> Puget Sound Regional Council TIP Amendment Proposal, Bicycle/Transit Travel Improvements. Seattle, Washington (September 28, 1992).

hours only. The remaining 25 percent thought that bicyclists should be able to bring bicycles inside the buses at any time.<sup>32</sup>

Metro surveyed the bus operators involved in the pilot project. Metro reported that 71% of the respondents cited no problems with the bike-in-bus method. The other 29% reported problems relating to a variety of concerns. Written comments from the operators were also received, in which 93% opposed allowing bicycles inside buses. Safety was the primary issue. Operators reported bicyclists running over passengers feet, scraping shins, and losing their hold on the bicycle. Other incidents included cyclists being unable to lift their bicycle onto the bus or bumping and scraping the bus interior. Cyclists required extra time to board if the bus was crowded, in order to avoid running into other passengers. Several operators cited not enough room inside the bus for both bicycles and passengers.

A consistent fear was the lack of a means to secure the bicycle inside the bus, to prevent it from taking flight during an emergency stop. This never actually happened; no accidents were reported. While other objects brought onto the bus, such as briefcases, books and umbrellas, could also become dangerous flying objects during a collision, the bicycle is seen as perhaps more dangerous due to its bulk and many protrusions and sharp edges. The bus operator's manual for Metro lists items prohibited from transport inside the bus. These include non-collapsible baby strollers, lawn mowers and similar equipment, uncovered sharp objects, flammable and explosive substances, and ski poles unless points are covered. Wheelchairs are not permitted on buses not equipped with tie-downs. Articles sometimes allowed inside the bus at the operator's discretion are carried roller skates/blades and skateboards, loaded shopping carts, collapsed shopping carts, collapsible strollers and folding bicycles under the following conditions:

"Folding bicycles may be allowed at the operator's discretion, providing that wheels and other frame extrusions such as pedals are stored in one compact form and do not pose a danger to other customers."<sup>33</sup>

The main problem cited about the bike-*in*-bus method was the lack of space for both passengers and bicycles inside the buses due to heavy bus ridership.

Originally the pilot program was to last six months, but after just one month, the program was ended due to concerns expressed by the Transit Safety and Risk Administration personnel, the Transit Union, Metro's security section and the Transit Committee's Security Task Force. A proposed resolution of Metro Council, which was not adopted, would have allowed bicycles inside buses on weekends only when the bus was less than 70 percent full, in the case that bike racks on the buses were not available.

---

<sup>32</sup> Metro Council. Rider/Nonrider Survey. A random telephone survey of 1200 regular bus riders in King County. 1992.

<sup>33</sup> Metro. *The Book, Transit Operating Instructions*, Metropolitan King County. (September 10, 1994 -- February 10, 1995): 616.

One result of the bike-in-bus demonstration program was that the front-mounted bike rack option seemed great to the bus operators in comparison to the bike-in-bus option. While most transit operators were opposed to carrying the bicycles inside the buses, they expressed favor toward installing bicycle racks on the outside. The issue became a question of determining the best bicycle transport method, rather than whether to have a bike-on-bus program.

All Metro buses have the interlock system, in which the buses will not roll as long as the doors are open. This provided an additional reason for using the front-mounted racks; the operator can see what is happening and maintain control of the bus to optimize safety of the passengers.

### **Vendor Selection Process**

When it was decided to remain with the front-mounted rack option, Metro carried out a vendor selection process based upon the degree to which each vendor could meet Metro's performance requirements and preferences. A schedule beginning with the time of the announcement of the RFP and ending with the contract award and first delivery of racks covered a period of six months.

A request for proposals was issued for the design, manufacture and delivery of the bicycle racks. A list of requirements was devised by representatives of all departments, including machinists, mechanics, operators and safety officers. The RFP required minimum insurance, including coverage during the course of the contract for bodily injury liability and property damage liability. The RFP also contained requirements of the Federal Transit Administration to maintain eligibility for award of the federal grant.

Metro required a parts list to be included in submitted proposals, in anticipation of the need to negotiate a procedure for ordering spare parts. The vendors submitting proposals were required to provide a 2-year guarantee of product workmanship. During this warranty period, if 20% of the purchased items failed for the same reason, it would be deemed as a "design defect", subject to modification and correction by the vendor within 60 days. The Municipality maintained the rights to any patents as a result of the contract.

As listed below, the RFP specified both required and desired features of a bicycle rack.<sup>34</sup>

#### *Required Bicycle Rack Features*

1. Bike racks must not have any loose parts that might be lost while unit is in operation.

---

<sup>34</sup> METRO, Municipality of Metropolitan Seattle. RFP Number 93-046, "The Design, Manufacture and Delivery of Bus Bike Racks." (September 1, 1993): 33.



*Required Bicycle Rack Features (cont'd.)*

2. Bike racks should not have any attachments. They must be self-contained units. The bus operators will not need to carry elements for the bike racks.
3. Bikes must be secure while bus is in motion.
4. The location of the rack should not block the driver's view, but it must be high enough so the bikes and rack do not hit the ground--at an 8 degree approach angle or less.
5. The loaded bike rack will not extend more than 36" beyond the front bumper.
6. The loaded bike rack will not obstruct the windshield or windshield wiper/washer operation.
7. Bike racks must be mounted to the front of the bus.
8. Bike racks must be compatible with all Metro bus fleet types.
9. Bike racks must not interfere with access and towing.
10. Replacement parts must be readily available.

*Desired But Not Required Bicycle Rack Features*

1. Bike racks should accommodate most standard type bicycles, including mountain and children's bicycles.
2. Bike racks should be user friendly to the cyclist.
  - a) Minimum loading and unloading time.
  - b) Cyclist should be able to secure the bicycle safely without driver assistance.
3. Bike racks should be securely attached to the front of the bus and easily removable.
4. Bike racks should be made of durable material to last ten years and will not rust or dent.
5. Bike racks should be light weight--less than 30 pounds.
6. Bike racks should be made of black, nonreflective material that will not damage the bicycles.

*Desired But Not Required Bicycle Rack Features (cont'd)*

7. Each bike rack should hold at least two bicycles and preferably more.
8. When the bike rack is not in use, it should not project beyond the front bumper of the bus.
9. Bike racks should allow loading and unloading of a bicycle, independent of any other bicycles on the rack.
10. Loaded bike rack should not project more than 26" from the front of the bus.
11. Bicycle should not sway or bounce while the bus is in motion.
12. The buses with installed racks should be able to go through the wash cycle without any assistance from a service worker or a mechanic.
13. Bike racks should not damage the brushes or the wash rack equipment beyond normal wear and tear.
14. Bike racks should not interfere with bus headlights.
15. Bike racks should be designed with the intent that bus riders are responsible for loading and unloading their bicycles within a timeframe of one minute and the operator may not leave the bus to assist with this process.

Metro did not consider bike theft from the rack to be a design issue.

The bidders were invited to examine the bus fleet on two separately scheduled days, in which all prospective vendors could visit the vehicle maintenance bases and take measurements and notes on bus specifications.

Prospective vendors could submit questions concerning the RFP via facsimile to a designated Metro senior buyer. Responses for a front-mounted rack design were received from thirteen vendors. Initial review of the thirteen submitted proposals was conducted by an ad hoc Proposal Technical Review Board of approximately 30 individuals representing Metro bus operators, maintenance personnel, other Metro departments, bicycle advisory committee members and selected county and city staff. Over a two-day period set aside for the purpose, the committee reviewed all proposals and selected three finalists to participate in a demonstration test.

Each finalist received \$3,000 for two bicycle racks, mounting hardware and instructions for use. Each rack design was tested on each type of bus. From the three selected finalists, two racks each were provided to Metro to test at selected stationary sites. During operations testing, Metro

found that the prototypes of the three selected finalists had to be modified prior to use by the public. Ultimately, just two out of the three prototypes were made available to customers to test because the third manufacturer was unable to make the necessary modifications. Metro set up a display booth with a set of the racks. Sites included the University of Washington in which students could compare and test the ease of loading and unloading their bikes on the racks. Other locations included industrial sites that generated high bus ridership.

The racks were not tested in service. Metro wanted to incur no risk until they received public input about the racks. The rack testing was conducted by selected bus operators who were also bicyclists. The rack testing was done at midday, so as not to interfere with the regular service routes of the bus operators.

Citizens could test the racks using their own bicycles. Participants then completed a survey that recorded their bicycle tire size, the bicycle wheel base size and the type of handlebars. There was an area on the survey for written comments to the following questions:

What features about this rack do you like?

What features about this rack do you dislike?

Any suggested changes for the manufacturer?

The participants were also asked to rate on a scale of 1 to 7, the "user friendliness" of the rack and how securely they felt their bike was fastened on the rack. Time in seconds was recorded for loading and unloading the racks.

In addition, a bike rack prototype survey was distributed to the bus operators for their input when testing the different bike rack prototypes after they were mounted to the buses. Five bus operators test drove each of five bus types, including the older and newer models of M.A.N. articulated buses, on a test course within the maintenance facility property. They conducted testing using road, mountain and children's bicycles. A copy of the bus rack prototype is included as Figure 5.

Bus washers are a brush based system provided by Sherman Supersonic, Inc., of Ontario, Canada. Depending upon weather and road conditions, buses are washed an average of three times per week. The selected rack had to pass safely through the routine bus wash cycles without damage done to the rack, the bus or the bus washing equipment. The complete testing phase also included an inspection of the racks for safety hazards to the user, an inspection of the impact, if any, on the headlight stream, turn signals and windshield wipers, a road test for rack durability and impact on bus operation, and testing by Metro personnel and bicyclists.

The rack was required to be mounted such that it neither obscured the bus operator's view, nor scraped the road surface on steep grades. The vendor designed the mountings to attach the racks

**FIGURE 5: Bike Rack Prototype Survey**

Seattle Metro

# BIKE RACK PROTOTYPE SURVEY

COACH #: \_\_\_\_\_ OPERATOR I.D.: \_\_\_\_\_ OPERATOR HEIGHT: \_\_\_\_\_ NAME OF BIKE RACK: \_\_\_\_\_ DATE: \_\_\_\_\_

Please fill out this survey when you test one of the prototype bicycle racks. Answer every question that is applicable to your participation in the test. For those rated items (0 - 10), the rating scale is as follows: 0 - 3 = poor; 4 - 5 = fair; 6 - 7 = good; 8 - 9 = very good; 10 = excellent. PLEASE circle only one number.

*Prior to test driving the coach or loading the bicycles, please rate the following:*

- |   |   |   |   |   |   |   |   |   |   |   |    |
|---|---|---|---|---|---|---|---|---|---|---|----|
| 1. Sharp edges (lack of) .....  | 0 | 1 | 2 | 3 | 4 | 5 | 6 | 7 | 8 | 9 | 10 |
| 2. Lack of pinch points (areas where fingers can get caught/pinched) .....  | 0 | 1 | 2 | 3 | 4 | 5 | 6 | 7 | 8 | 9 | 10 |
| 3. Non-interference with headlights and turn signals .....  | 0 | 1 | 2 | 3 | 4 | 5 | 6 | 7 | 8 | 9 | 10 |
| 4. Non-interference with wiper/washer operation .....   | 0 | 1 | 2 | 3 | 4 | 5 | 6 | 7 | 8 | 9 | 10 |
| 5. Operator's view of the road (vision obstructed?) .....   | 0 | 1 | 2 | 3 | 4 | 5 | 6 | 7 | 8 | 9 | 10 |
| 6. Can you see the closed rack from a normal seated position? Yes ___ No ___ Open rack? Yes ___ No ___                  |   |   |   |   |   |   |   |   |   |   |    |
| 7. Can you see the closed rack if you lean over from a normal seated position? Yes ___ No ___ Open rack? Yes ___ No ___ |   |   |   |   |   |   |   |   |   |   |    |

*Please rate the following items regarding the loading the bicycles:*

- |  |   |   |   |   |   |   |   |   |   |   |    |
|--|---|---|---|---|---|---|---|---|---|---|----|
| 1. Operator's view of the loading process (can it all be seen clearly?) .....  | 0 | 1 | 2 | 3 | 4 | 5 | 6 | 7 | 8 | 9 | 10 |
| 2. Smoothness of bike rack operation .....   | 0 | 1 | 2 | 3 | 4 | 5 | 6 | 7 | 8 | 9 | 10 |
| 3. Likelihood of avoiding passenger injury during the loading process .....  | 0 | 1 | 2 | 3 | 4 | 5 | 6 | 7 | 8 | 9 | 10 |
| 3.1. Non-interference with headlights and turn signals .....   | 0 | 1 | 2 | 3 | 4 | 5 | 6 | 7 | 8 | 9 | 10 |
| 3.2. Non-interference with wiper/washer operation .....  | 0 | 1 | 2 | 3 | 4 | 5 | 6 | 7 | 8 | 9 | 10 |
| 4. Can the inside bike (closest to the coach) be loaded independently? Yes ___ No ___                                    |   |   |   |   |   |   |   |   |   |   |    |
| 5. Please record the amount of time to load the first bike (in seconds): _____ seconds (NOTE: load in outside position.) |   |   |   |   |   |   |   |   |   |   |    |
| 6. Please record the amount of time to load the second bike (in seconds): _____ seconds (NOTE: load in inside position)  |   |   |   |   |   |   |   |   |   |   |    |

*Please rate the following items while driving the coach in the yard:*

- |   |   |   |   |   |   |   |   |   |   |   |    |
|---|---|---|---|---|---|---|---|---|---|---|----|
| 1. Amount of bouncing/swaying, etc. ....                        | 0 | 1 | 2 | 3 | 4 | 5 | 6 | 7 | 8 | 9 | 10 |
| 2. Amount of bouncing/swaying during/after an abrupt stop ..... | 0 | 1 | 2 | 3 | 4 | 5 | 6 | 7 | 8 | 9 | 10 |

*Please rate the following items while driving over the test course:*

- |   |   |   |   |   |   |   |   |   |   |   |    |
|---|---|---|---|---|---|---|---|---|---|---|----|
| 1. Amount of bouncing/swaying, etc. ....                                | 0 | 1 | 2 | 3 | 4 | 5 | 6 | 7 | 8 | 9 | 10 |
| 2. Operator's view of the road (vision obstructed or distracted?) ..... | 0 | 1 | 2 | 3 | 4 | 5 | 6 | 7 | 8 | 9 | 10 |
| 3. Amount of contact between the bicycles .....                         | 0 | 1 | 2 | 3 | 4 | 5 | 6 | 7 | 8 | 9 | 10 |
| 4. Security of the bicycles (is either one likely to fall off?) .....   | 0 | 1 | 2 | 3 | 4 | 5 | 6 | 7 | 8 | 9 | 10 |
| 5. Is the inside bike coming into contact with the bus? Yes ___ No ___  |   |   |   |   |   |   |   |   |   |   |    |

*Please answer the following questions upon returning to the base:*

- Can the inside bike be unloaded independently? Yes \_\_\_ No \_\_\_
- If so, can it be unloaded from the passenger side? \_\_\_ front side? \_\_\_ operator's side? \_\_\_
- Please record the amount of time to unload the inside bike (in seconds): \_\_\_\_\_ seconds
- Please record the amount of time to unload the outside bike including securing the rack (in seconds): \_\_\_\_\_ seconds

**COMMENTS (on any of the above items, suggestions, needed modifications, etc.)**

---



---



---



---



---

**THANK YOU FOR YOUR ASSISTANCE! YOUR PARTICIPATION IS APPRECIATED.**

to the buses, to achieve sufficient clearance below and preserve the bus operator's view. One alteration was made to all the buses to accommodate the mounting brackets. The racks are



*During rack prototype testing, Seattle Metro found that the existing latch mechanism did not prevent the rack from bouncing while in the unfolded position.*

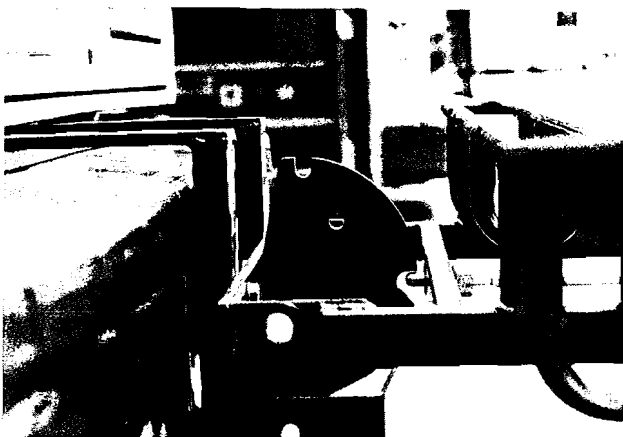

*The manufacturer modified the rack design to include a new latch that eliminates the bouncing problem and secures the rack in both the unfolded. . .*



*. . . and unfolded positions.*

attached to the bumpers of the buses by two brackets that clamp around the bumper. Two small openings, approximately one half inch high and two inches long, were cut into the bottom edge of the metal front hatch of each bus to allow clearance for the two brackets.

The racks were tested on the roughest roads. Some bouncing of the rack did occur. This was remedied by a special modification to the latch that prevents the wobbling.

A requirement that was not met by any of the three finalists was that the rack, when folded up, did not extend more than 6 inches from the bumper. The selected rack does extend more than 6 inches, but is still compact enough not to cause any problems.

Metro has experienced no safety problems with the racks. An informal study recently compared the safety record of ten routes served by 31 rack-equipped buses, against the rest of the fleet and found that the safety records were similar. The vehicle maintenance supervisor believes that the rack equipped buses may be operationally safer due to some greater degree of operator hesitance and care in operating the bus.

Metro's experience has found that the average bicyclist using the bike-on-bus service can generally load or unload the rack in 10-30 seconds.

Enabling the public the opportunity to try the racks and especially enabling the bus operators and other personnel the opportunity to test the racks and provide input into the decision making regarding the selection of equipment was instrumental to encourage cooperation by transit agency employees in the bike-on-bus program. That the Metro Council also listened when bus operators and others expressed concern about the bike-in-bus demonstration and preference to discontinue it, also showed that the input of the operators mattered. Throughout the course of planning for the bike-on-bus program, operations personnel were kept posted of the latest developments through summaries in the monthly "Operations Bulletin."

After a vendor was chosen, a contract was drawn up for the purchase and delivery of 1,190 racks and 1,190 sets of mounting hardware for a total price of \$614,040, not including sales tax. All versions of mounting hardware to fit all ten bus types were the same price. The vendor was selected based upon survey results addressing user-friendliness, ease of loading/unloading, safety, ease of maintenance and the comments from the public. Metro ultimately selected a local company, a public relations bonus by providing business for the regional economy.

### **Program Implementation**

After the vendor selection, the racks were purchased and stockpiled. The challenge was to synchronize the bus operator training with the motor coach retrofit. The East Base Vehicle Maintenance supervisor negotiated with the bus operators union to expedite the coach retrofit by paying overtime to a retrofit assemblyline to work during a period of several weekends. The first time that personnel assembled the selected racks, including unpacking the units, it required approximately two hours for the assembly of one rack. With experience, assembly time was reduced to approximately one hour per rack.

To enhance the bus operator's view of the rack, small convex lenses supplied for approximately \$8.00 per lens from a manufacturer of recreational vehicles, were mounted to the bus windshields by Metro machinists, giving the bus operator the entire view of the unfolded bicycle rack.

The first buses to be equipped were those serving routes that cross over Lake Washington on the Evergreen Point Floating Bridge serving State Route 520. This route connects downtown Seattle destinations and the University of Washington to Eastside communities, including Bellevue.

Disappointment was expressed that budget constraints and program scheduling difficulties disallowed Metro from having the fleet fully equipped and the program completely underway by the start of the season of anticipated peak ridership, which includes the less rainy summer months.

Bicyclists are not permitted to use the bike-on-bus service in the free ride area in downtown Seattle which is in operation from 6 a.m. to 7 p.m. In downtown Seattle there is a defined area known as the free ride zone in which bus passengers ride for free. It is within this area that bicycles are not permitted to be loaded or unloaded from the bicycle racks during peak hours because of the high volume of bus traffic serving many routes. The degree of stacking requires every bit of curb space. The front-mounted bicycle racks require approximately three feet, then at least another three feet is required to allow clearance for a bicyclist to load his bicycle. For each bus to require an additional six feet would impede the timely stopping to pick up and discharge passengers. The bike-on-bus service is available at all times, including peak periods.

Metro's policy is that a maximum of two bicycles per bus are permitted to be transported. If the rack is full, then a customer wanting to transport his bicycle must wait for the next bus. If the bus operator consistently must pass up bicyclists, he is advised to submit an Incident Report.

Seattle Metro has four bases, East Base, South Base, Central/Bellevue Base and North Base. All bus operators are stationed at one of these bases. The operators were trained by base and the buses were outfitted with racks by base. However, not all the buses serving a route are based from the same garage. The challenge of this was to keep the customer service representatives informed as to which runs of a particular route would have rack-equipped buses.

Similar to MDTA's line-up, Seattle Metro holds a "pick" every quarter to assign routes to bus operators according to seniority. The result of this is some turnover of bus operators from one base to another. Metro intended for their own maintenance personnel to install and maintain the racks without purchasing training from the selected manufacturer. Seattle Metro instructs bus operators using a video that was produced in-house with the use of project funds. Written rules of operation for bus operators with regard to bike-on-bus are planned.

Because workers' compensation claims have reached a peak for back injury from causes unrelated to the bike-on-bus service, Metro was particularly concerned about bus operators helping bicyclists load and unload bicycles from the rack. Metro's policy is to strongly discourage bus operators from helping bicyclists although the operator may offer verbal instructions to the

bicyclist when needed. Removal of bike racks would be done by a mechanic, sheet metal worker or an equipment service staff person.

Metro has not found any operational problems relating to narrow streets or roadways and bus stop design as it relates to operating the bus equipped with a front-mounted bicycle rack. Instructions for operating the bus consist of one paragraph in the bus operator's manual:

"When in use, the rack adds three feet to the length of the coach. Allow for this additional clearance requirement on turns, when pulling in and out of bus zones, and when stopping. Be sure to allow adequate space between coaches in zones for customers loading/unloading bikes."<sup>35</sup>

The manual also contains instructions on how to share the road safely with bicyclists.

The Metro personnel training was conceived of and developed by committee. The training is one hour long, composed of thirty minutes of classroom instruction and thirty minutes of practice operating the bus with the bicycle rack attached. Presently, half of the operators are trained and half of the fleet is rack equipped. Metro personnel consist of 2,400 bus operators and 200 supervisors. Approximate costs have been budgeted at \$40,000 for initial training and \$25,000 for future hired personnel and any retraining or retrofitting that will require program modifications.

Once the program start-up is complete, a Bike-on-Bus section of Metro will be established. Ongoing operations will be supervised by one Metro representative in the Capital Projects division. This position will be responsible for all issues related to the bike-on-bus program, including program response to legislative developments, community requests and media relations.

A permitting program has been considered unnecessary because of the ease of use of the racks. Metro's philosophy is to conduct their program in the easiest manner possible. Metro does not plan to use a formal training program for the bicyclists because there is not the staff or the budget to do so. Instead, there will be customer brochures explaining the service and a listing of program rules. Ms. Erin Laine is a Metro project manager and also sits on the Board of the Cascade Bicycle Club. She said, "Someone that's never used one of these [racks] can walk up the first time and use them without using a manual or reading a lot of instructions. The learning curve is once."<sup>36</sup>

---

<sup>35</sup> Metro. *The Book, Transit Operating Instructions*, Metropolitan King County. (September 10, 1994 -- February 10, 1995): 675.

<sup>36</sup> Dale Steinke, "Eastside firm nabs Metro deal," *Journal American* (May 17, 1994): A1.



One brochure, entitled, "Metro Racks Up a Great Travel Option: Bike & Ride," gives step-by-step instructions as follows<sup>37</sup>:

*Loading Your Bike*

1. Always load and unload your bicycle from the curb side.

*Loading Your Bike (cont'd)*

2. Pull down to release the folded bike rack. You only need one hand to pull the rack down, so you can hold your bike with your other hand.
3. Lift your bike onto the rack, fitting wheels into the slots. Each slot is labeled for front and rear wheels. Please load your bike in the outside slot first.
4. Raise and release the support arm over the top of the front tire. Make sure the support is resting on the tire and not on the fender or frame.

*Unloading Your Bike*

1. Tell the driver you need to unload your bike before you approach your stop.
2. Raise the support arm off the tire. Move the support arm down, out of your way.
3. Lift your bike out of the rack.
4. Fold up the bike rack if there is no other bike in the rack.

The brochure provides detailed illustration, riding tips and phone numbers for additional information. See Figure 6 for a copy of the brochure.

The marketing department will be heavily involved with customer relations, nonmotorized access studies and the provision of bicycle lockers. Presently, Metro provides a recorded message called BUS-TIME, which receives approximately 1,800 calls per day for bus schedule information. This will be used in the future to market the bikes-on-bus service. The marketing department will also be using corporate media releases and purchasing a full page in the *Seattle Post-Intelligencer* to inform the public.

---

<sup>37</sup> Metro. "Metro Racks Up A Great Travel Option: Bike & Ride," Brochure. Metropolitan King County. September, 1994

FIGURE 6: Bikes-On-Bus Brochure

# METRO RACKS UP A GREAT TRAVEL OPTION: BIKE & RIDE



## METRO INFORMATION

For bus route and schedule information, call Metro's 24-hour Rider Information at 553-3000. (TDD users, call 684-1739.)

This information is available on request in accessible formats for persons with disabilities by calling Metro at (206) 684-2046 or (206) 689-3413 (TDD users).

Effective March 2001 on Metro buses by November 2000

9/94 604



## BIKE AND RIDE TIPS

You may load or unload your bike anytime at any Metro bus stop except within the Ride Free Area in downtown Seattle between 6 a.m. and 7 p.m. During these hours you need to load or unload your bike at one of the stops that form the Ride Free Area boundaries.

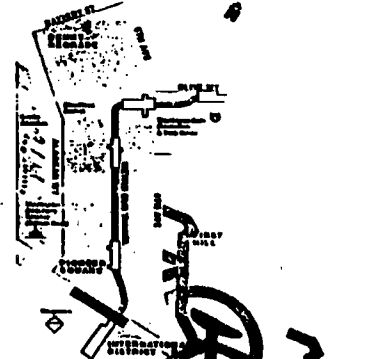

If your bus is an express route that makes its first or last stop inside the Ride Free Area, you may load or unload at the first or last stop that your route makes within the Ride Free Area.

In the tunnel, loading and unloading bikes is allowed at Convention Place and International District stations only. Please use the elevators to transport your bike to the plaza level.

The bike rack holds two bicycles. If the rack is full, you will need to wait for the next bus.

## OTHER BICYCLING RESOURCES

Metropolitan King County RoadShare Program 296-RIDE

- Spot Improvement Program
- Road and Trail Information
- Regional Bicycle Planning & Programs
- King County Bicycle Gudemap (available at REI and other King Co outlets)

Washington State Department of Transportation 440-4738  
Northwest Region Bicycle and Pedestrian Program

City of Seattle Bicycle Program 684-7584

- Bicycle Packs on Sidewalks
- City of Seattle Bicycle Map
- Spot Improvement Program

Bellevue Bicycle and Pedestrian Program 637-6146

- Bicycle Planning
- Bellevue Bicycle Map
- Local road improvements

Cascade Bicycle Club 522-BIKE

- Bicycle Education
- Advocacy and Government Affairs
- Rides and Special Events

Operational instructions devised for the bicyclist wanting to use the bike-on-bus service are:

- No additional fare is required for the bike.
- Customers are responsible for loading and unloading bikes.
- Customers may load/unload bikes at any Metro bus zone except within the Ride Free Area from 6 a.m. to 7 p.m.
- If the rack is carrying two bicycles already, the next customer must wait for the next bus. Bicycles are not allowed inside the bus.
- Operators are not to call the coordinator in the case of bike overloads. If there are any problems, an Incident Report should be submitted.
- Operators should check the rack before leaving the base, especially to ensure that the rack locks in the open and closed positions. Malfunctioning bicycle racks are to be reported on work order forms for which a new code, Body Exterior--Bike Rack, was added.
- Operators are not to use their four-way flashers when loading/unloading bikes unless they are otherwise required.<sup>38</sup>

Since the establishment of the bike-on-bus program, there have been no claims and no rate increase. Seattle Metro is self-insured. The bike-on-bus program is not perceived to increase exposure. METRO does not use a waiver of liability. Metro's legal staff have advised Metro not to indicate that a hazard exists by warning of a hazard in the form of the liability waiver. If a passenger were to file suit, Seattle Metro would settle out of court.

The grant-funded program requires evaluation but this has not yet been conducted. The evaluation will include operator count cards, a customer questionnaire for both bicyclists and nonbicyclists, a bus operator survey, records of customer complaints and statistics on collisions and other reported incidents. Metro is concerned less with the number of rack-equipped buses and the number of cyclists using the service, but rather whether Bikes-on-Bus is meeting the service demand of the cycling community.

#### **BIKE-IN-BUS PROGRAMS, SAN JOSE AND SACRAMENTO, CALIFORNIA**

An investigation of bike-*in*-bus programs--allowing bus patrons to bring their bicycles aboard the bus--indicates that few such programs exist in the United States. The case studies presented

---

<sup>38</sup> Metro. Operations Bulletins #2249 and #2269. Seattle Washington. 1994.

above show that many urban areas consider, then reject the bike-in-bus option, largely due to perceived safety risks, space limitations inside the bus, the potential for boarding/exiting delays and the concern that bus interiors would become soiled with grease and mud. The greatest advantages of a bike-in-bus program are that no rack equipment must be purchased or maintained nor is it necessary to conduct information campaigns about their operation. For purposes of exploring the potential of the bike-in-bus option, the search was unsuccessful for identifying programs in which the implementing agencies were dedicated to maximizing program effectiveness. Although some programs are implemented systemwide, no program was identified that collects data or conducts evaluation. Nonetheless, it appears that the best established bike-in-bus programs exist in California, two of which will be briefly described here.

### **Sacramento**

Sacramento Regional Transit started a bike-in-bus program in the late 1980's that allows bicyclists to bring their bicycles onto both the bus and light rail vehicles during non-peak hours. Bicyclists have requested peak hour access. Ridership is not monitored by the agency. Complaints have been received by regular passengers that bicycle grease has soiled transit vehicle interiors. In order to board buses, bicyclists are ordinarily required to enter via the back door and proceed to the back of the bus in order to expedite efficient boarding, but operators cannot open the back doors of older buses. Bus operators are not permitted to help bicyclists board or exit buses. No written instruction is available to bus operators. The bike-in-bus program is implemented through a simple permitting procedure, in which the bicyclist pays \$5.00 and signs an application outlining the program rules, in exchange for a 3-year permit. Figure 7 presents a copy of the permit application. A permit list, which has not been updated, has contained as many as 3,000 program participants at one time.<sup>39</sup>

### **Santa Clara County**

The Santa Clara County Transit District Board adopted a policy in November, 1990, allowing bicycles inside buses on all 73 County transit routes and aboard light rail vehicles. An initial demonstration program included 40 bus routes. The "Bikes On Us" Basic Guidelines are the established policies that must be followed by program participants.<sup>40</sup>

---

<sup>39</sup> Information about the bike-in-bus program of the Sacramento Regional Transit District was obtained from interviews with Kirk Schneider and Joseph Costa of the Sacramento Planning Department, November 18, 1994, and Sheryl Patterson, Attorney, Sacramento Regional Transit District.

<sup>40</sup> Santa Clara County Transportation Agency, Planning and Capital Development Division, Planning and Programming, *Santa Clara County Bicycle Plan*, March 1994 (San Jose, CA): 25-26.

FIGURE 7: Bicycle Permit Application

Permit Number: \_\_\_\_\_



Sacramento Regional Transit District

# Bicycle Permit Application



Name: \_\_\_\_\_

Mailing Address: \_\_\_\_\_

Street

City

State

Zip Code

Phone Number: Work \_\_\_\_\_ Home \_\_\_\_\_

Social Security Number: \_\_\_\_\_ Today's Date: \_\_\_\_\_

Bicycles will only be allowed on Sacramento Regional Transit vehicles with a valid permit. The permit will be issued for a period of three (3) years. A \$5.00 permit fee will be charged. No credit for lost or stolen permits. The permit is subject to the following conditions:

### Boarding Times:

Bicycles are not permitted on a bus or light rail vehicle during weekday peak periods (6:00 a.m. - 9:00 a.m. and 3:30 p.m. to 6:00 p.m.). On Saturdays, Sundays and holidays, bicycles may be transported at any time.

### Light Rail Vehicle Boarding Procedures

A maximum of two bicycles will be allowed on each light rail vehicle during the specified times. Boarding will be on a first come, first served basis. Passengers with bicycles must board through the rear doors only. Bicycles will be confined to the rear wheelchair seating area with the seat cushion raised (see diagram on back). The bicycle must be secured by the owner so as not to protrude into the aisle. Bicycles may not inconvenience any rail passenger.

### Bus Boarding Procedures

Only one bicycle will be permitted on each bus. The bicycle must be secured in the aisle as close to the rear seat as possible. In no event may a bicycle be stored ahead of the rear passenger door. Bicycles may not inconvenience any bus passenger.

### Restrictions

Bicycles may be restricted from being transported at any time due to passenger loads or limited seating. Bicycles which are muddy, dirty or greasy are prohibited. Bicycles can not be longer than 80 inches nor higher than 48 inches. No motorized bicycles are allowed. The bicycle permit must be displayed to the bus operator upon boarding, or any Sacramento Regional Transit District employee on request.

*I have read the conditions under which a bicycle may be transported on Sacramento Regional Transit buses and light rail vehicles. I understand that failure to follow these requirements will result in the permit being revoked immediately. Permits are non-transferable. Permits issued to one person cannot be used by someone else.*

Signature: \_\_\_\_\_ Date: \_\_\_\_\_

If purchasing bike permits by mail, return the completed application and the \$5 permit fee to Regional Transit, Customer Service Department, P.O. Box 2110, Sacramento, CA 95812-2110

Revised 5/99

**FIGURE 7: Bicycle Permit Application (cont'd.)**

### **Regional Transit Bicycle Permit Diagram**

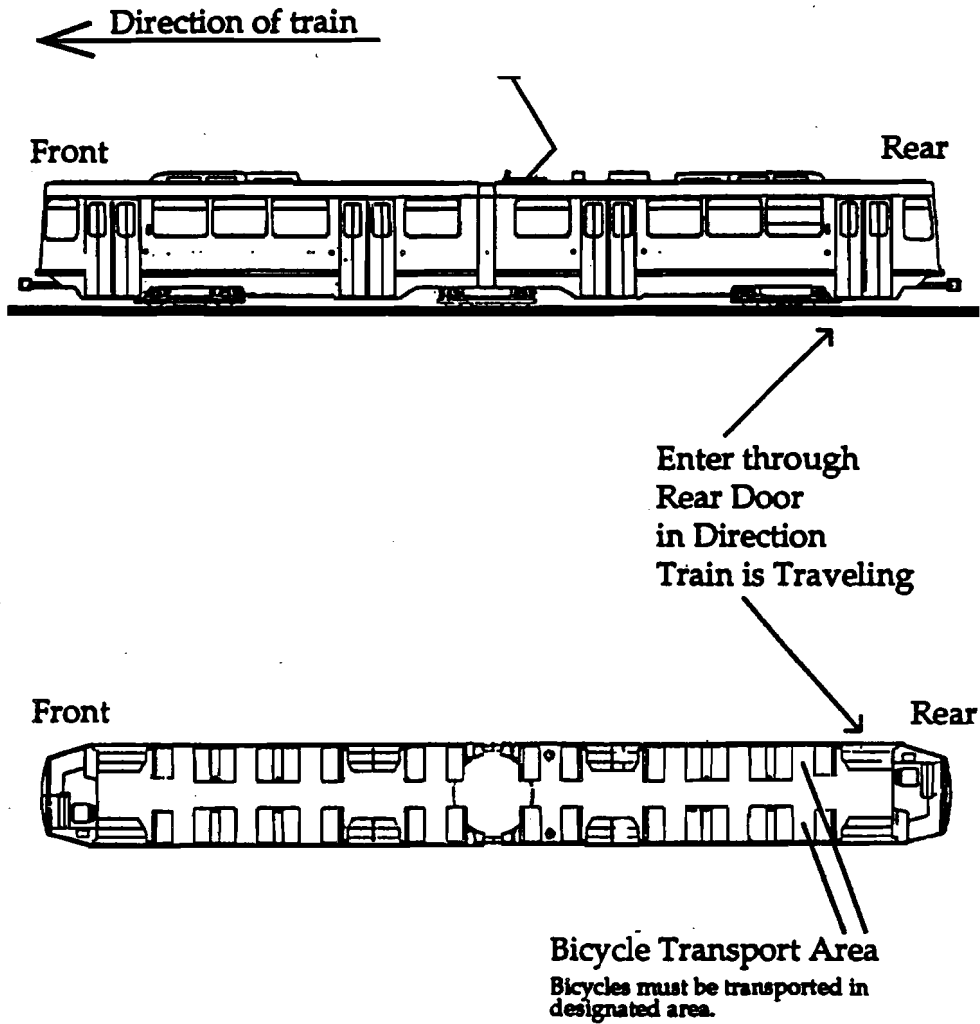

**Note:** Each car can accommodate two bicycles. This would mean that four bicycles could be carried in a two-car train, etc.

There are general guidelines for participation and they are as follows:

### *Boarding and Loading*

- The bicyclist is responsible for loading and unloading his bicycle.
- The maximum bicycle size is 80 inches long by 48 inches high and no motorized or muddy bicycles are allowed.
- The bicyclist must allow other passengers to exit and enter the bus before boarding or exiting.
- The bicyclist must follow the driver's request to board the next available bus if the bus is too full to accommodate bicycles.
- The bicyclist must board the bus through the rear door only.

### *On Board*

- While on board the bicyclist is responsible for securing his own bicycle firmly and must stay with the bike at all times.
- The bicyclist must keep the doorways, walkways and exits clear.
- The bicyclist must allow other passengers room to sit or pass.
- The bicyclist must avoid getting chain and sprocket grease on the bus.
- In an emergency situation, bicycles are to be left on board.
- If the bus has folding seats in the rear, the bicyclist will lift the folding seat and position the bicycle so that it does not block aisles or doors.

### *Unloading*

- Before the bus reaches the bicyclist's destination, the bus driver should be informed that the bicycle will need to be unloaded.
- After the bicycle is removed, the bicyclist should move away from the bus and signal the driver to move on.

A local bicycling coalition originally advocated the need for the "Bikes On Us" program. The bike-in-bus option was selected to avoid the cost of rack purchases and to address concerns about the effect of exterior bicycle racks upon the bus washing apparatus. No records have been maintained concerning bike-in-bus ridership, although a recent light rail ridership survey indicated that four percent of those surveyed brought their bicycles aboard light rail.<sup>41</sup> No fees must be paid nor does a permitting system exist but information about the policies are provided by

---

<sup>41</sup> Phase III Market Research, *Santa Clara County Transportation Agency Light Rail Passenger Survey*, prepared for the Santa Clara County Transportation Agency, Department of Planning and Grants, August 1993 (San Jose, CA): 4.

brochures and safety cards located inside the buses. While some passenger complaints have been received concerning the program, the amount of dollar claims related to the "Bikes On Us" program are considered minimal by transit staff.<sup>42</sup>

---

<sup>42</sup> Information concerning the "Bike on Us" program was obtained through interviews with Dennis Moshon, Marketing Manager, and Sylvia Alvarez, Planner III of the Santa Clara County Transportation Agency, October 20, 1994.



## **EQUIPMENT AND TECHNOLOGIES TO FACILITATE BIKES-ON-BUS SERVICE**

A bike-on-bus demonstration program must initially use an existing fleet of buses of particular physical and operating characteristics, an existing system of roadway, bus stop and garage maintenance facilities, and a fleet of various types and sizes of bicycles, owned and operated by bus service customers. It would be required of a new program to function within the constraints of these existing conditions.

Several options for transporting bicycles on buses were identified and evaluated in relation to the needs of passengers wanting to transport their bicycles aboard buses, the needs of passengers without bicycles, the characteristics of the bicycles to be transported and the characteristics of the buses. Consideration was also given to the existing conditions of the roadways and bus stops relative to the use of the bicycle transport options, and the operational efficiency, ease of maintenance and cost of each option.

This section was developed by initially reviewing analyses and recommendations provided in several recent studies on the topic of bicycle transport on buses.<sup>42</sup> Information was also gathered by directly contacting bike-on-bus program managers from several urban areas. Garage and maintenance facilities of the MDTA were toured, in addition to those of other transit agencies that are featured as case studies. Information was gathered from bicycle retailers on the range of bicycle types that are currently on the market, in addition to reviewing bicycle catalogues and related periodic literature. Roadway and bus stop information was obtained from interviews with Dade County operations and engineering personnel. Bus fleet characteristics and other data were obtained from MDTA planning staff and from Section 15 reports of the Federal Transit Administration.

### **BUS CHARACTERISTICS**

The bus fleet owned by MDTA is comprised of 612 active buses, described in Table 7. Two main types of buses are currently used for the standard routes.

---

<sup>42</sup> Recent informative studies include:

John T. Doolittle, Jr. and Ellen K. Porter, "Integration of Bicycles and Transit," *TCRP Synthesis 4*, Transportation Research Board (Washington, D.C.: National Academy Press, 1994).

Michael Replogle and Harriet Parcels, "Linking Bicycle/Pedestrian Facilities with Transit," *National Bicycling and Walking Study, FHWA Case Study No. 9* (Washington, D.C.: USDOT, October 1992).

Michael Replogle, "Bicycles and Public Transportation: New Links to Suburban Transit Markets," (The Bicycle Federation, 1988).

**TABLE 7:  
Metro-Dade Transit Agency  
Motor Coach Inventory**

Year & Type	Number of Buses	Passenger Capacity	Number of Buses with Wheelchair Accommodations
1993 FLX, Metrobus	73	43 seated 11 standing	73
1992 FLX, Metrobus	15	43 seated 11 standing	15
1990 FLX, Metrobus	93	43 seated 11 standing	3
1988 FLX, Metrobus	87	46 seated 11 standing	0
1987 FLX, Metrobus	129	46 seated 11 standing	0
1985 NCC	9	19 seated 4 standing	0
1980 GMC, RTS II	206	43 seated 11 standing	0

Source: Section 15 Report, Federal Transit Administration, 1993.

These routes include the 69 routes that provide regularly scheduled service. Of the main types of buses owned and operated by MDTA, the first type, the RTS II made by GMC is designed to carry 45 seated passengers and 11 standing. The second main type of bus in use is the Metrobus made by The Flxible Corporation. These buses are designed to carry 43 or 46 seated passengers and 11 standing, depending upon the model year. The smaller NCC buses are used for special services and are probably not candidates for the bike-on-bus service. Both the Metrobus and the RTS II have the same standard dimensions. The buses are 40 feet in length, 8 feet 6 inches wide and 10 feet 4 inches high. There are plans to retire the RTS II buses that are being used by MDTA. The transit agency is currently purchasing 60-foot articulated buses made by Ikarus and 40-foot Metrobuses from Flxible. This is expected to continue due to a multi-year contract. The articulated buses have the same basic dimensions as the Flxible except that they have two attached sections that extend their total length to 60 feet. There are currently 20 articulated buses that are owned by MDTA and 10 of them are in service. These are not

shown in Table 7 because they were received in FY 1994. There will be 51 articulated buses in service by the end of 1995.

## **BICYCLE CHARACTERISTICS**

Bicycles are owned by some segment of existing and potential bus passengers to meet a variety of transportation and recreational needs. New bicycles sold today range in price from about \$70 to several thousands of dollars. The average price of a bicycle ranges from \$150 to \$600.

Those bicycles that will be transported by the bikes-on-bus service will be those that bus passengers will most likely have purchased prior to the start of the program, before there was any reason for the bus passenger to consider ease of bicycle transport by bus.

### **Bicycle Type**

In order for the bike-on-bus program to serve a transportation need, it should be able to accommodate those types and sizes of bicycles generally used by the targeted market segment. Based upon the experience of other urban areas, bike-on-bus service has attracted a portion of the market of transit-captive bus passengers, and to a lesser extent, discretionary riders. These have included blue-collar workers and students using the bike-on-bus service for commuting purposes. Bike-on-bus programs of other urban areas have also targeted recreational bicyclists, many of whom ride with children. As a result, such programs accommodate the range of bicycle types as well as sizes. The buses should be capable of carrying hybrid style bicycles with wide tires as well as road bicycles with narrow tires.

Not all bicycle types can presently be transported by existing bicycle transport options. For example, tandems, recumbents and tricycles are not carried on bicycle racks mounted to the front of buses. However, the accommodation of all bicycle types may not necessarily be reasonable or desirable from the standpoint of program efficiency and safety. A policy decision should be made regarding the range of bicycle types to be transported. It is recommended that MDTA limit those types and sizes of bicycles that can be carried, based upon those bicycles in use by some majority of potential program customers or based upon the limitations of bicycle transport options currently available on the market. This approach would be easier and less costly to implement.

Knowledge of the range of bicycle types on the market, bicycle development trends and consumer purchasing preferences, can aid in this policy decision. Such knowledge also can help in the development of specifications for bicycle transport equipment that will resist obsolescence over its useful lifetime.

Nationwide, while the number of bicycles sold annually has been generally constant, the trend in bicycle sales since 1986 has shown a decrease in the number of lightweight touring or road bicycles sold, and an increase in the number of middleweight mountain bicycles and hybrid

bicycles sold. While the mountain bicycle would primarily be used for recreation, the rising interest in hybrid bicycles may indicate a desire for an all-purpose vehicle that offers a slower, more stable ride to those bicyclists more interested in utility and comfort and less interested in long distance touring and racing.

Mountain bicycles (or off-road bicycles) are distinguished from road bicycles by their greater range of low gears, wider tires and an upright riding position. A hybrid or cross bicycle is a mountain bicycle with a different frame and modified tire tread that makes it safer and easier to ride on paved surfaces.<sup>43</sup>

### **Bicycle Size**

Critical size dimensions of bicycles include tire width and diameter, frame size and the overall height and width of pedals and handlebars. Such dimensions will vary by type of bicycle. The standards that are used to measure bicycles depend on the style of bicycle that is being considered. Road bicycles are typically measured in metric units. However, the off-road and hybrid or cross purpose bicycles typically use British units.

Bicycle size is generally referenced by frame size. The approximate range of bicycle frame sizes on the market for all bicycle types, representing both children's and adult bicycles, are from 14-inch to 27-inch frames using the British standards or from 50cm to 63cm using the metric standards. The frame size is measured along the seat tube from the center of the bottom bracket to the top of the top tube as shown in Figure 8. Figure 8 also shows how the "stand over" height is measured. This dimension is helpful in determining the overall height of bicycles that will need to be considered. The maximum stand over height is typically approximately 34-inches. The seat extends above this dimension, but it is adjusted for each individual rider. There can be large variations in the seat height, but generally it will not extend over 12 inches above the top tube.

The tire size, which is measured using the diameter and the width of the tire, can be varied separately from the frame. Generally if bicycles are purchased from a retailer as an assembled unit it is up to the discretion of the manufacturer to decide which tire diameters will be used for each frame size they produce. However, if an individual were to purchase the frame and tires separately, then they would have the option of choosing a tire size to fit their needs. Standard tires range from 11 inches to 27 inches in diameter or 280mm to 680mm. The tire width is also variable, typically between 1 1/4 inches to 2 inches (32mm - 51mm). The smaller tire widths are typically found on road bicycles and the larger widths are on mountain bicycles.

---

<sup>43</sup> *Bicycling Reference Book, 1993-1994* (Washington, D.C.: Bicycle Institute of America, 1993), 7.

**FIGURE 8: Illustration of Bicycle Measurements**

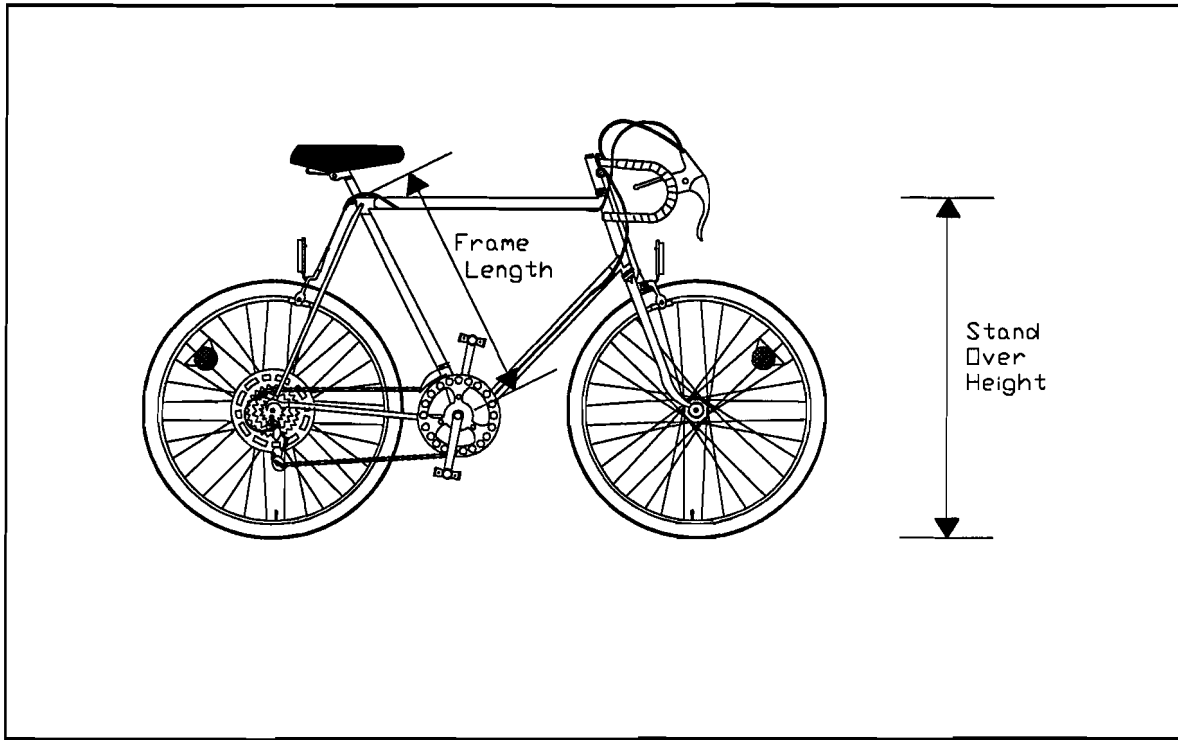

There are also several styles of handlebars that are currently available. The standard handlebars on the market have handle to handle widths ranging from 18 inches for a child's bicycle to 28 inches for a Cruiser type mountain bicycle. The height of the handlebars should not be an area of concern. Generally the height of the handlebars is even with or lower than the seat height. There is one style of handlebars in which the handles extend above the seat, but this type is not commonly available except on a child's bicycle. The overall height of a child's bicycle with this style of handlebars will still be less than the height of a typical size adult bicycle. Baskets and panniers attached to the bicycle generally do not exceed handlebar width.

The width from the end of one pedal to the end of the other pedal is also a pertinent dimension. This dimension ranges from 14 to 15 inches depending upon the particular bike. There is little variation in this dimension from bicycle to bicycle. There is only one inch increase in this distance in comparing a child's size bicycle to an adult's size bicycle. Because the variation is small and the width of this dimension is less than the range for handlebars, the overall bicycle width will be taken from the handlebar dimensions.

These sizes account for the majority of bicycles that are available. The information was supplied from several manufacturers' catalogs and interviews with local bicycle retailers.<sup>44</sup> The bicycle dimensions described above are important when considering different bicycle transport options. For example, if the front-mounted bicycle rack option were chosen, the placement of the rack would have to be fastened to the front of the bus such that the tallest bicycles to be accommodated did not block the driver's view and that handlebars did not interfere with windshield wipers. Bicycle dimensions relative to the dimensions of bus interiors are also important if consideration were given to allowing bicycles to be transported in the passenger compartment of buses.

## **BICYCLE TRANSPORT OPTIONS**

Bike-on-bus programs identified across the United States represent five options for transporting bicycles on buses.<sup>45</sup> These are:

- a rack mounted to the front of the bus;
- a rack mounted to the rear of the bus;
- trailers pulled behind the bus;
- bicycles contained in bus luggage compartment; and
- bicycles carried inside passenger compartment.

### **Bus Luggage Compartment**

A very small number of transit agencies have buses that are equipped with a storage area under the floor to carry bicycles below the passenger area. Roaring Forks Transit Agency in Aspen, Colorado uses this style of bus on some of their longer express routes. During the non-skiing season, cyclists are allowed to store their bicycles in the lower compartment. When using this service, the rider must be able to put the bicycle into the baggage area without assistance from

---

<sup>44</sup> Manufacturers' catalogues include:

*The Gears are Always Turning: Diamond Back 1995 Bikes*, WSI California, California, (1994).

*Bicycle Guide*, Peterson Publishing Company, USA (October 1994).

*Performance Bicycle*, Chapel Hill, North Carolina, (Summer 1994).

*1994 Schwinn Youth Bikes*, Schwinn Cycling and Fitness Inc., USA (1993).

<sup>45</sup> Transportation Research Board. Transit Cooperative Research Program. Synthesis of Transit Practice 4, *Integration of Bicycles and Transit*, Washington, D.C. (1994): 14.

the driver.<sup>46</sup> This type of service does not require any additional equipment for the bus and it avoids the chance of passenger and bicyclist conflicts that is present with the bike-in-bus service option. The option of loading bicycles into the luggage area under a bus will not be reviewed because MDTA buses in the existing fleet are not equipped with this type of storage area, nor are there future plans for purchasing buses with this type of storage capacity.

### **Trailers**

The option of using trailers that can be pulled behind a bus has the primary advantage of being able to transport large numbers of bicycles, up to twelve, depending on the type of trailer. This method of transporting bicycles had been used satisfactorily in Santa Barbara, California. The trailer method is best suited for longer routes, often with physical barriers along the route such as bridges or mountainous roads. One of the most suitable routes for this service in Santa Barbara accessed a university by way of a road up a steep hill. The trailer service here was successful when it was in use, but the maintenance costs were high and the service was ended due to budget cuts.

While trailers have been tried in other urban areas, it is recommended that they not be considered for use in Dade County. The demand estimation for the bike-on-bus service does not indicate that the use of trailers is warranted. Other disadvantages of trailers have been documented.<sup>47</sup> For example, pulling trailers increases the difficulty of negotiating turns by buses, and loading/unloading of bicycles from the trailers cannot be watched by the bus operator. The cost of equipping each bus with a trailer is also more expensive than the cost of front- or rear-mounted bicycle racks.

There are three remaining options for transporting bicycles on buses, which will be reviewed in greater depth. These include the use of front- and rear-mounted racks and in-vehicle transport.

### **In-vehicle Transport**

Another method for transporting bicycles aboard buses is to allow the bicycles inside the passenger area of the bus, referred to in this report as "in-vehicle transport" or "bike-in-bus." This method has the advantage of not requiring the purchase of any new equipment to begin the service.

---

<sup>46</sup> *Ibid.*, 13-23.

<sup>47</sup> *Ibid.*, 14.

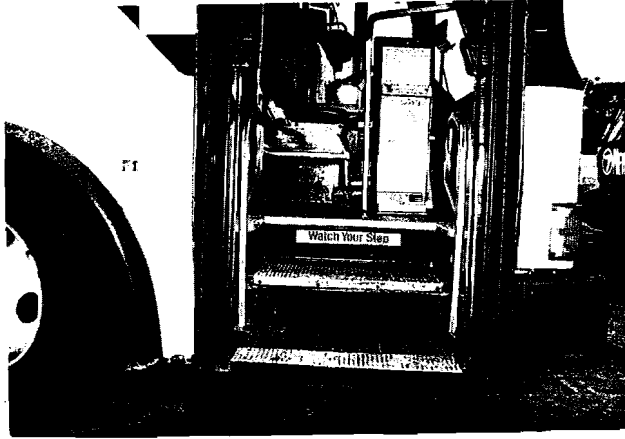

*For transport inside a bus, the bicycle must be lifted up three steps, then turned to the left toward the aisle.*



*The back stair well provides limited width for exiting with a bicycle.*

MDTA presently does not have an explicit policy regarding the transport of bicycles inside buses; however, a bus operator using his discretionary power would probably disallow bicycles aboard after determining that due to their size, they will interfere with the safe operation of the bus and the safety and comfort of other passengers. Bicycles might be considered similarly to unfolded carriages and strollers, which are not permitted.<sup>48</sup>

The overall dimensions of a bicycle must be considered if the bike-*in*-bus option were to be used. The bicycles would have to fit within the doors and be maneuverable inside the bus to position it out of the way of other passengers and not block the aisle.

Upon entering MDTA buses by way of the front step well, the height from the ground to the first step is approximately 13.5 inches. The last two steps that ascend to the floor of the bus are both approximately 10 inches high. In the back step well, used for exiting the bus, the height of each step corresponds to those in the front step well but the back step platforms are smaller than those in the front, requiring greater care while alighting. Each back step is approximately 12.5 inches deep and 34 inches wide. The front step well width is greater.

---

<sup>48</sup> Metro-Dade Transit, *Metrobus Bus Operator's Manual*, 1994. See "Articles, Packages and Baggage," and "Baby Carriages and Strollers," p. 15.



The interior geometry of the buses in the existing fleet would generally not limit the types and sizes of ordinary road, mountain and children's bicycles that can be carried inside a bus. Factors of greater influence on the use of this option tend not to be whether it is possible to carry bicycles inside the bus, but rather the awkwardness, delay and safety hazards potentially caused by carrying bicycles up and down the front and back step wells of the bus and the limited aisle space for maneuvering the bicycle into a safe storage position once inside the bus.

A safety consideration for transporting bicycles inside buses is to secure them so that they do not roll while the bus is in motion. This can be accomplished to some degree by requiring the cyclist to hold the bicycle in place or the bicycle can be strapped in by using the wheelchair securements. MDTA buses that were purchased in 1992 and later, provide areas for patrons in wheelchairs. These areas include a three-seat bench that folds up to make room for wheelchairs. Some are located in the front of the bus while others are in the rear. The top view layout of a bus can be seen in Figure 9. The diagram identifies the typical locations of wheelchair areas within the buses.

**FIGURE 9: Wheelchair Lift Equipped Bus  
Typical Overhead View**

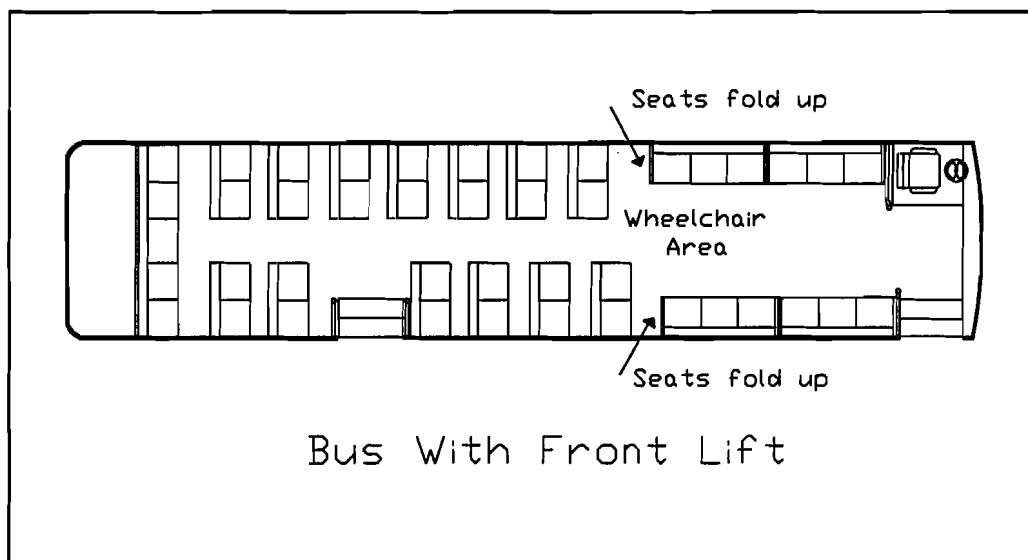

There are usually tie-downs from the floor or the wall that are used to keep the wheelchair in place while the bus is in motion. Some transit systems that allow bicycles inside the bus require bicycle storage in the wheelchair-equipped area. The wheelchair area is approximately 20 inches wide and 53 inches long but an average adult bicycle is longer than 53 inches and must be positioned diagonally in this area. Because the wheelchair fasteners were not designed for bicycles, they are not optimal for this purpose. Bicycles would be prevented from forward/backward motion, but not lateral movement.

If the bike-in-bus method were chosen for testing, a policy decision should be made on the priority of the use of the area for wheelchair patrons and cyclists. An MDTA on-board survey conducted in the Spring, 1993, determined that an average of 5 percent of passengers reported physical disabilities. The overall range per route varied from 0 to 11 percent.<sup>49</sup> The percentages of wheelchair passengers are expected to be lower than the percentages of all physically disabled passengers. Because these percentages are low, there may be less conflict than anticipated between the bicyclists and the wheelchair patrons trying to use the same section of the bus. However, MDTA has been very successful with mainstreaming customers formerly using Specialized Transportation Service (STS). As all MDTA buses become wheelchair lift-equipped, it is anticipated that MDTA will be serving thousands of trips by passengers with disabilities. It is recommended that if bicycles were permitted inside buses, that clear priority be given to customers with disabilities for the use of the space inside buses designed for wheelchairs. This means that a bicyclist would have to exit the bus if a customer in a wheelchair were to board and needed the space.

It is worthy to note briefly that folding bicycles are available on the market. The more simply designed bicycles can be folded in approximately 10 seconds to dimensions of approximately 3 feet by 3 feet by 1 foot. Folding bicycles can be purchased in the \$350 to \$500 price range.<sup>50</sup> Any serious consideration of the bike-*in*-bus option should not limit eligible bicycles to only the folding variety. Due to their high price and limited versatility, few people own them.

Aside from bike-in-bus transport, the most immediately adaptable feature of the overall physical bikes-on-bus system is the bike-carrying rack that can be mounted to the bus. These racks have been produced by several manufacturers to conform to the characteristics of buses, bicycles, bus washing facilities and other aspects of the system. If a policy choice were made not to allow bicycles inside buses, but rather to select a bicycle rack option, then it must be decided whether MDTA should select an existing bike rack design and tailor its service policies to the limitations of existing designs (for example, the range of bicycle types that can be accommodated), or whether MDTA should define its service parameters and ask interested manufacturers to create a new design to meet their particular specifications.

### **Rear-mounted Racks**

Bicycles are loaded onto a rear-mounted rack so that their front tires are against the rear of the bus and the bicycle is lengthwise with the front up towards the top of the bus. In this position, bicycles can be loaded side by side allowing up to six bicycles on a rack, a major capacity advantage. A bicycle is loaded by lifting the front tire into the track on the rack and then by

---

<sup>49</sup> Center for Urban Transportation Research. "MDTA On-Board Survey Analysis: Final Report." Tampa: University of South Florida, May 1994.

<sup>50</sup> *Accordian Bikes*, Bicycle USA, March/April 1993, 10-13.

rolling the bike into position. The securing mechanism is then locked to hold the bicycle in place on the rack.



*Racks mounted to the rear bumper of a bus cannot be seen by the bus operator, exposing bicycles to greater risk of theft.*

Very few transit systems in the United States use rear-mounted racks. There are three main reasons why rear-mounted racks are less popular for use. Since the rack is mounted on the rear of the bus, it is difficult for the driver to monitor any activity with the rack. Secondly, the rack is secured over the engine compartment and must be removed to service the bus. The Flxible buses are equipped with maintenance hatches on both the front and rear ends of the bus. Other buses used by MDTA also feature deceleration lights located above the rear maintenance hatch. View of these lights may be obstructed by a rear-mounted rack. Third, rear-mounted racks generally must be removed before the bus passes through a brush style wash.<sup>51</sup>

### **Front-mounted Racks**

Manufacturers of front-mounted racks were located by using the Thomas Register, in addition to information provided by transit systems featured as case studies.<sup>52</sup> Rack manufacturers provided information to explain the features and functions of their racks so that the currently available options could be analyzed. Manufacturers included Sportworks, Boreas Design, Inc., American Bicycle Security Co. and KOR Product Designs. Information was also obtained about the Yakima automobile roof rack that was retro-fitted in-house by Portland Tri-Met, for use as a front-mounted bicycle rack.

Front-mounted racks carry either two or four bicycles depending on the style. The activity on the front rack is easily monitored by the bus driver. Bicycles can be loaded quickly and easily

---

<sup>51</sup> Integration of Bicycles and Transit, Transportation Research Board, National Research Council, (1994) : 11-24.

<sup>52</sup> Thomas Register 1994, Products and Service Section. (Thomas Publishing Company, New York, NY, 1994) BIC/2406.

on these types of racks. The racks are constructed using steel and stainless steel with the steel parts paint coated to avoid rusting. Front style racks are mounted either in a receiver hitch or directly to the front bumper of the bus depending on the style.

Of the five options reviewed for transporting bicycles by bus, it is recommended that MDTA adopt the use of front-mounted racks. While the method of transporting bicycles inside buses has some merit, it lacks consistency with the goal of Dade County to mainstream STS customers to use the regular fixed route service. The front-mounted rack method maintains consistency with this policy by creating added capacity for bicycles on the outside of buses, creating no additional conflict for space on the inside. The discussion below describes various types of front-mounted racks.

## **FRONT-MOUNTED RACK STYLES**

### **Prong Style Bicycle Rack**

There are at least three different styles of front mounted racks that have been developed. An early design that has been used for several years in some urban areas is a prong style bicycle rack, consisting of two support arms extending from a main brace. The main brace is hooked to the bus by inserting it into a receiver hitch. The bicycles are placed on this type of rack by hanging them over the extended arms. There are two variations of this type of rack, one accommodates four bicycles and the other accommodates two.

Due to the design of this type of rack, the bicycles must be removed in the reverse order from which they were loaded. This style of rack must be removed from the bus to allow for access to maintenance hatches in the front. It is not necessary to access the hatch on a daily basis, however it does need to be opened periodically. The bicycles are suspended from the rack by their frames; therefore, it may be difficult to secure a "walk through" style bicycle that does not have an upper frame bar or a child's bicycle that has a small frame. The arms of the rack remain in the extended position even when there are no bicycles on it.<sup>53</sup> Due to the many difficulties involved with commercial use of these racks there is limited availability of them. The prong style rack was previously used in Metropolitan King County, Washington but the platform style has been chosen for their recent system-wide implementation.

### **Platform Style Bicycle Rack**

The second type of front-mounted rack is a platform style in which the bicycle tires rest on the rack frame. When using this rack the bicycles are lifted into the slots in the frame and they are secured by attaching a support arm. The support arm is used to secure the bicycle while the bus

---

<sup>53</sup> Integration of Bicycles and Transit, Transportation Research Board, National Research Council, (1994) : 11-24.

is in motion. One rack design uses an arm that is spring loaded so that it only contacts the tire. Other designs use a Velcro strap or clamp that hooks on the bicycle frame. Phoenix Transit System uses a rack that employs Velcro strap fasteners. The platform rack with the spring loaded arm is currently in use in the HARTline program. Two bicycles can be carried on this style of rack and the bicycles can be removed independently of each other.



*Seattle Metro equipped their buses with a platform style bicycle rack.*

The rack can be folded up and secured when it is not in use so that it extends a minimal amount beyond the bumper. Bicycles can be loaded or unloaded from the front or the curb-side of the bus by the cyclist without any assistance in approximately 20-60 seconds. When the rack is in the unfolded position and ready for use, it extends approximately 30 to 36 inches beyond the bumper.<sup>54</sup> Figure 10 shows a platform style rack that is made by Sportworks NW, Inc.

### **Track Style Bicycle Rack**

A third variation of front-mounted racks is the track style rack. This rack has similar characteristics to the platform rack that was described previously. The rack has a track that the bicycle tire is placed in to allow the bicyclist to roll the bicycle into the rack rather than lift the bicycle onto the rack. This rack does not fold up against the bus. The rack remains in the ready position for the first bicycle even when the rack is empty. In order to place another bicycle on the rack the second track must be extended.<sup>55</sup> The KOR track style rack is shown in Figures 11 and 12. Figure 11 shows the rack in the closed position for one bicycle. Figure 12 shows the rack in the extended position so that two bicycles can be transported.

---

<sup>54</sup> Information from manufacturers' literature provided by the following companies: Sportworks, Boreas Designs, and the American Bicycle Security Company.

<sup>55</sup> KOR Rack: Bus Bike Rack, KOR Product Design, (1994).

**FIGURE 10: Platform Style Bicycle Rack from Sportworks NW, Inc.**

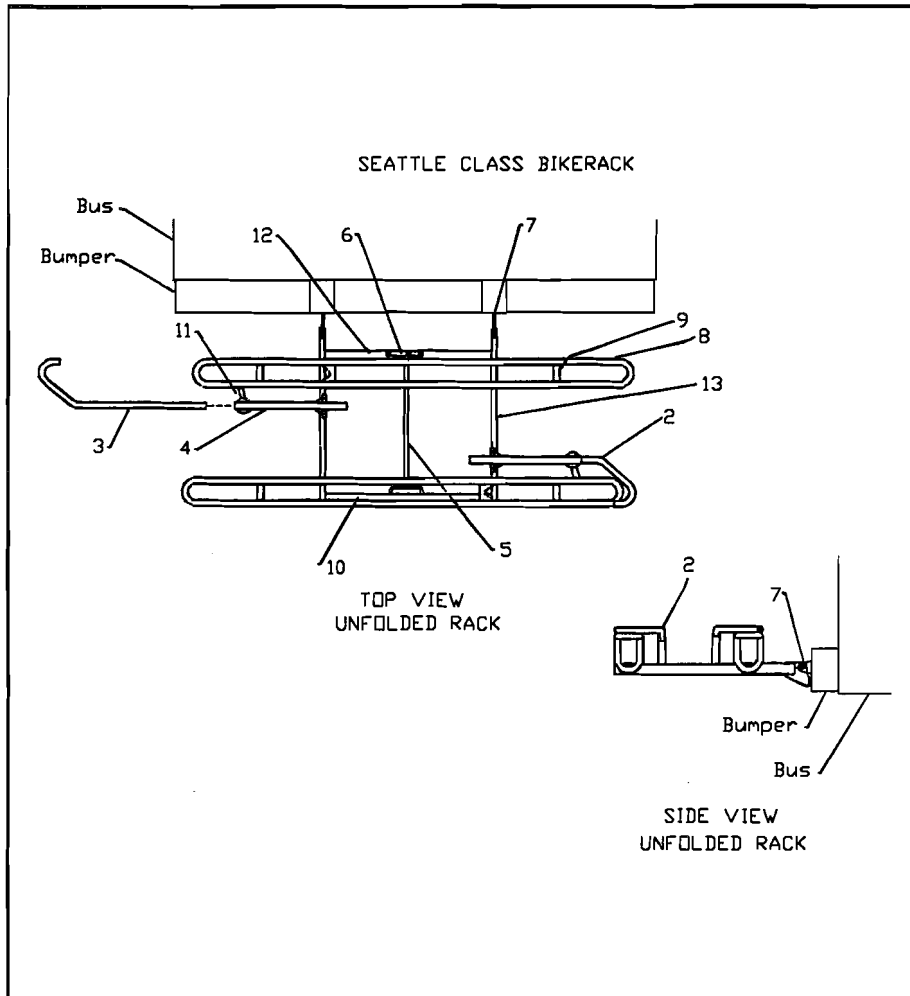

Source: *MT2 Bicycle-Rack-for-Buses Specifications*, Sportworks NW, Inc.

**Description of Components:**

- |                        |                 |                  |
|------------------------|-----------------|------------------|
| 1) Main Frame          | 5) Latch Handle | 9) Saddle        |
| 2) Support Arm         | 6) Latch        | 10) Lowering Bar |
| 3) Support Arm Hook    | 7) Pivot Tab    | 11) Magnet Arm   |
| 4) Support Arm Housing | 8) Hoop         | 12) Latch Bar    |

**FIGURE 11: KOR Track Style Rack Closed Position for One Bicycle**

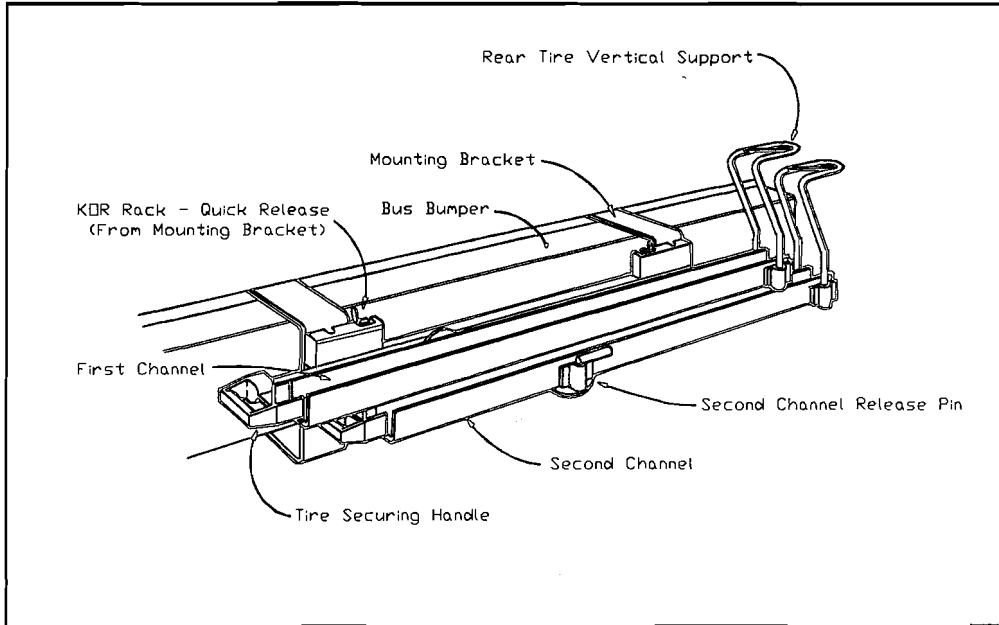

Source: *KOR Rack: Bus Bike Rack*, Informational Brochure KOR Product Design.

**FIGURE 12: KOR Track Style Rack Extended Position for Two Bicycles**

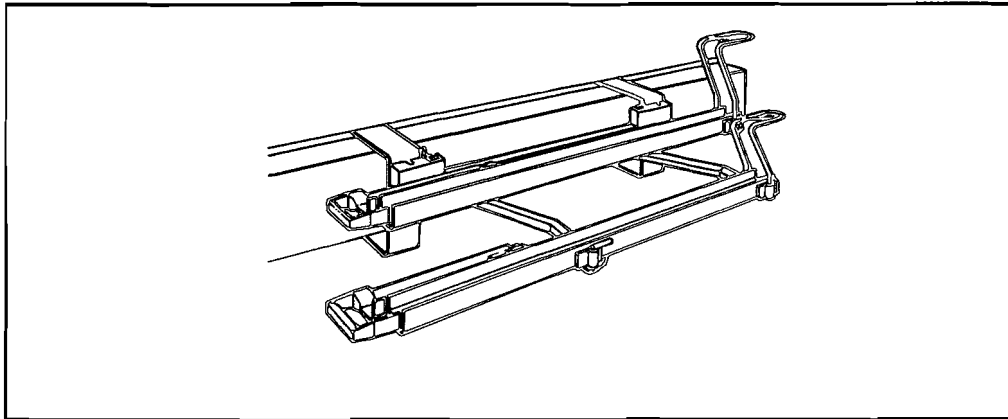

Source: *KOR Rack: Bus Bike Rack*, Informational Brochure KOR Product Design.

## ATTACHMENT METHODS

The method that is used to mount a front rack depends upon the rack itself and the bumper to which it is mounted. Table 8 shows the types of racks and the possible mounting conditions that can be used.

**TABLE 8:  
Front Rack Mounting Conditions**

Type of Rack	Mounting Conditions	Bus Type
Prong Style	Receiver Hitch	All
Platform Style	Slide-in Bracket	GMC RTS II Flxible Metrobus Ikarus Articulated
	"C" Bracket	Flxible Metrobus Ikarus Articulated
Track Style	"C" Bracket	GMC RTS II Flxible Metrobus Ikarus Articulated

The prong style rack requires a receiver hitch below the bus bumper for attachment. Both the track style and the platform style racks are mounted directly to brackets on the bumper of the bus. This is accomplished by mounting two "C" brackets around certain bumper styles or two slide-in brackets through other styles of bumpers. The rack is then attached to the mounting brackets. Some racks come with adjustable mounting brackets, so that the rack position can be changed. All of the racks require a specific bracket style for each bus bumper type.

The typical bumper on the Flxible buses is a semi-pneumatic energy absorbing Atlas bumper.<sup>56</sup> The bumper on an articulated bus is similar to the bumper on a Flxible. The back structure of the bumper is constructed from extruded aluminum and the front cover is made of urethane. The RTS bumper is slightly different in shape and structure than the Atlas bumper, but the construction materials are the same. The Flxible buses can use either the Slide-in bracket or the "C" bracket if the appropriate clearance above the bumper is available.<sup>57</sup>

<sup>56</sup> *Flxible Metro: The Advanced Design Bus*, The Flxible Corporation, USA (1994):14.

<sup>57</sup> Duncan Smith, Transit Garage Supervisor, November 22, 1994, telephone interview.



The RTS buses would primarily use a slide-in style bracket. The major difference in the brackets is the attachment method that is used. The "C" brackets are attached by drilling holes in the top and the bottom of the bracket and bolting this directly to the aluminum extrusion structure. The standoff style bracket attaches to the aluminum structure through the front portion. Holes must be drilled through the Urethane structure from the front and then into the aluminum extrusion. The cut-away views of these bumpers are shown in Figure 13.<sup>58</sup> All of these methods use two identical brackets that are evenly spaced on the bumper, in order to support the rack.

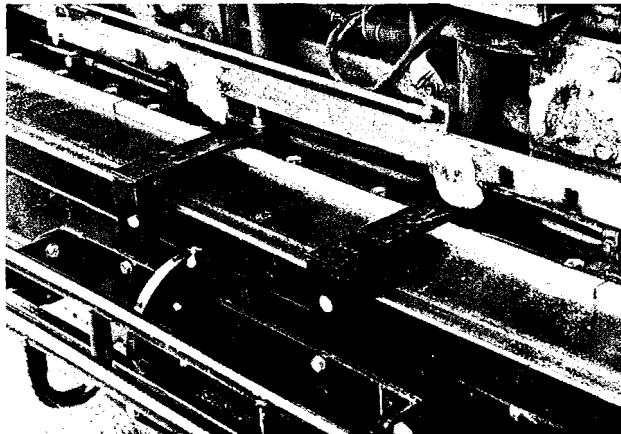

*Seattle Metro attached the platform style bicycle rack to the front bus bumper using a "C" bracket.*

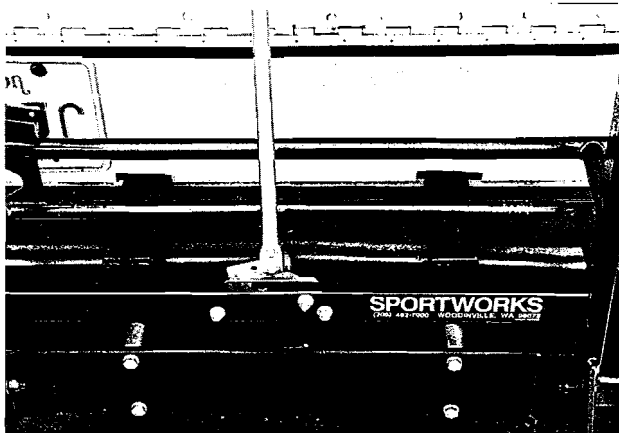

*Seattle Metro cut slots in the front panels of the buses to accommodate the rack mounting assembly.*

---

<sup>58</sup> Sportworks Installation Manual: 11, 25.

**FIGURE 13: Cut-away Side View of Bumpers and Brackets for the Flexible and RTS Buses**

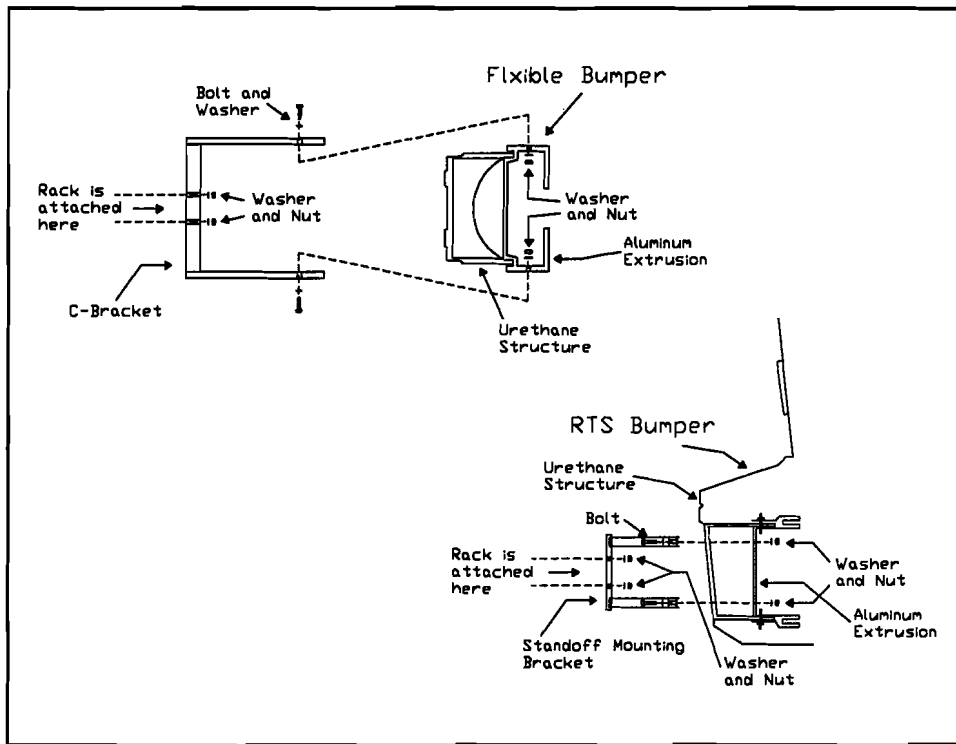

Source: Sportworks NW, Inc. Installation Manual: 11, 25.

Table 9 provides a comparative summary of additional rack features. These four manufacturers constitute a sample rather than an exhaustive listing of rack manufacturers. Table 9 is intended to provide the reader with an understanding of the front-mounted rack styles currently on the market. All featured rack designs are of the platform type, except for the KOR Product Design, which is a track style rack.

Many similar attributes are identified. All of the primary materials that are used in the racks are similar. The main structures of the racks are constructed of steel that has been covered with a powder coat paint. The moving parts of the racks are typically constructed from stainless steel or anodized aluminum. The materials and finishes that have been used should protect the racks from rusting due to prolonged exposure to atmospheric conditions.

## BUS WASHING

The bus washing system that is used by MDTA is made by Ross and White. This stationary system is a covered facility with several aisles through which the buses are driven every night

by the hostlers. There are three rotating brushes that clean the bus, one on each side and one on the top. As the front of the bus passes through the washer, approximately 8 inches along the top and side edges of the bus come in contact with the bristles. The remaining portion of the front and back of the bus is washed by hand.<sup>59</sup> All of the racks featured in Table 9 have been designed so that they can remain on the bus during bus washing without causing damage to the washing brushes or the rack itself.

## **RACK DESIGN COMPARISONS**

The KOR rack has been designed so that it is always in the down position; therefore, lifting the rack is not required. The KOR rack is also designed so that bicycle tires rest in a track. This track allows the bicyclist to lift one tire at a time and to roll the bicycle along the track. On the KOR design, the first track of the track style rack is always in the ready position. The first bicycle is put into place by lifting the securing handle and lifting the front tire into the track. The bicycle is then rolled forward and the rear tire is lifted into the track. The bicycle is secured by lowering the securing handle onto the tire. The securing handle is spring loaded to hold the bicycle in place. The second track must be extended by pulling the release pin and extending the track. The second bicycle can then be secured in the rack.

The racks from Sportworks NW, Inc., Boreas, the American Bicycle Security Company and the retro-fitted Yakima roof rack are similar in design. For use of these racks, the bicyclist must release the latch and lower the rack into the proper position. Once the rack is down the cyclist can lift the bicycle onto the rack and secure it with the support arm.

The Sportworks rack can be raised and lowered with one hand so that the bicyclist can keep one hand on the bicycle to steady it before loading. The Sportworks support arm is held in the down position by a magnet. The cyclist needs to lift the handle and secure it on the bicycle tire. This is done by pulling up on the handle and placing it on the tire where the spring loaded mechanism holds it securely in place.

The Yakima retro-fitted roof rack that was designed in-house by Portland Tri-Met, secures the bicycles by a clamping mechanism that is attached to the frame of the bicycle. There is also a Velcro strap that goes over the clamp for added security.

---

<sup>59</sup> Duncan Smith, Transit Garage Supervisor, November 22, 1994, telephone interview.

**TABLE 9:  
Comparative Attributes of Four  
Front-Mounted Bicycle Racks**

<b>Manufacturer</b>	<b>Sportworks NW, Inc.</b>	<b>American Bicycle Security Co.</b>	<b>Boreas Design, Inc.</b>	<b>KOR Product Design</b>
Bicycle types that can be accommodated	All types that have wheels with diameters of 16" or larger	All types that have wheels with diameters of 20" or larger	Up to 80" long and 48" wide with 20" - 28" wheels	All types from children to long touring bikes
Rack Dimensions (when in position for use)	Rack extends 27" forward from the brackets and is 66" wide	Rack extends 28" forward from the brackets and is 64" wide	Rack extends 36" forward from the brackets	Rack extends 24" forward from the brackets and is 87" wide
Weight	under 30 lbs	28 lbs	61 lbs	70 lbs
Time required to load or remove Bike	Approximately 20 seconds to load or unload	Approximately 20 seconds	45 -60 seconds	10 - 20 seconds
Securing system	Support arm with spring loaded mechanism that contacts only bike tire	Support arm with spring loaded mechanism that contacts only bike tire	Steel security arm with Velcro strap that secures to bike frame	Securing handle that contacts only bike tire
Method of rack attachment	Two bolts attached to each bracket	Two bolts attach rack to each bracket	Rack attached by two clevis pins	Quick release mechanism that uses levers to unhook

**TABLE 9:  
Comparative Attributes of Four  
Front-Mounted Bicycle Racks (cont'd.)**

<b>Manufacturer</b>	<b>Sportworks, Inc.</b>	<b>American Bicycle Security Co.</b>	<b>Boreas Design, Inc.</b>	<b>KOR Product Design</b>
Position when not in use	Stored position against bus with minimal protrusion	Stored position against bus with minimal protrusion	Stored position against bus with minimal protrusion	Track for first bike always down and ready for use
Prototype available for testing	No, but will consider written request	Yes	Yes	Yes
Warranty	1 year on material defects and workmanship	1 year on manufactured defects	1 year on workmanship and 90 days on moving parts	1 year on parts and labor
Cost Schedule Sept. 1994	1 Rack \$365 2 HELP mounting brackets \$145 2 RTS mounting brackets \$175	1 Rack \$300 2 Mounting brackets \$150	# of racks 1 - 20 \$689 21 - 74 \$669 75 -100 \$649 100 + Quote (brackets included)	1 rack and 2 brackets \$509

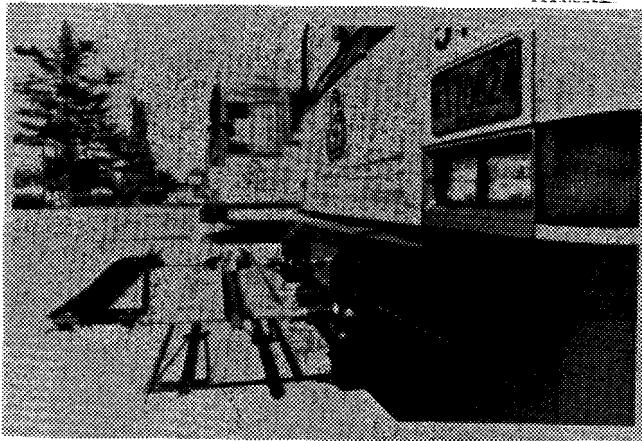

*Portland Tri-Met retrofitted a Yakima car roof rack for use on buses.*

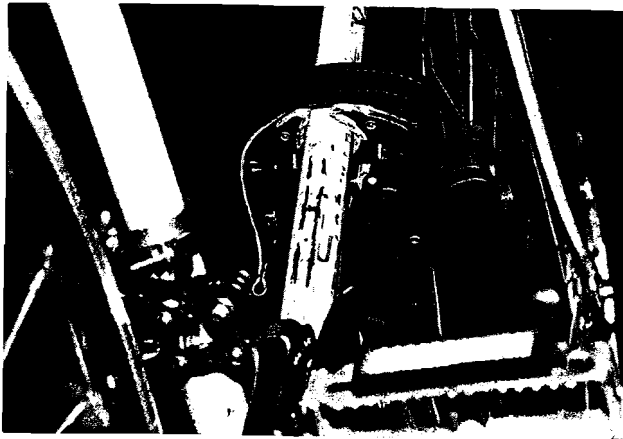

*The rack employed by Portland Tri-Met has an adjustable mechanism that clamps around the bicycle frame with a velcro strap.*

The Boreas rack is used in a similar manner except that the securing arm must be raised before the bicycle is put into place. Once the bicycle is on the rack it is then secured by wrapping the Velcro strap around the frame of the bicycle. The support arm on the Boreas rack is held in place by a Velcro strap that is attached to the frame of the bicycle. The Boreas rack has reflective tape to increase the visibility of the rack to other drivers. This rack is also designed to collapse on impact to cause a minimal amount of damage to the bus in the event of an accident.

### **RECOMMENDED OPTION**

A review of the options analyzed indicates that the front-mounted rack option and the in-vehicle transport option appear to have the most potential, based on their adaptability to the conditions in Dade County as well as their success at other transit agencies. As indicated by the case studies, urban areas that have instituted bike-on-bus programs have almost always selected the bicycle rack option that is mounted to the front of the bus. The racks currently available on the market have been manufactured with a primary consideration to accommodate bicycles of as

many different shapes and sizes as possible. Available front-mounted rack designs meet performance specifications addressing ease of loading/unloading, weight, compactness, compatibility with wash equipment and ease of removal. Unlike in-vehicle transport, in which bicycles may take space that would otherwise comfortably accommodate bus passengers, the bicycle rack creates additional capacity to accommodate bicycles while not affecting the passenger area.

The manufacture of bicycle racks is a rapidly growing industry and new firms are entering the market. It is anticipated that by the time MDTA is prepared to investigate available bicycle transport equipment, new designs may be available. For this reason, MDTA should refrain from pre-selecting a specific rack make and instead obtain the latest information.

### ADVERTISING PANELS

MDTA uses the front, rear and side panels of the buses for advertising. Front advertising panels tend to be less noticed by the public than the side and rear panels. Consultation with the advertising contractor indicates that sales from advertising on the fronts of buses never approach 90 percent of the existing space. It was determined that there would be no impact on advertising revenues if less than 10 percent of the existing panels were removed.<sup>60</sup> For purposes of a bike-on-bus demonstration program, trial use of front-mounted bicycle racks should not adversely affect revenues from bus panel advertising. However, the use of the racks on all bus routes as part of a permanent program may have an impact on advertising revenues. This issue should be reviewed further prior to a decision regarding systemwide implementation of a bike-on-bus service using bicycle racks.



*Front advertising panels on buses tend to be less noticed by the public than the side and rear advertising panels.*

---

<sup>60</sup> Judy Emerson, Transit Economic Development Specialist, Metro-Dade Transit Agency. Memorandum to Joel Volinski, August 29, 1994.

## RACK VISIBILITY

Visual inspection of the buses and discussion with MDTA maintenance personnel indicate that the corners of some front bus bumpers show wear from minor collisions. Racks can be designed to include reflective tape or paint to maximize motorists' ability to see the rack.

Typical mirror configuration for MDTA buses include four mirrors with one on each side of the bus, a rear-view mirror and a rear exit door mirror. These mirrors do not include a view directly in front of the bus.<sup>61</sup> The driver has no visibility in this area extending 48 inches from the front bumper. The blind spot can be eliminated either by adding front side mirrors or by attaching a convex lens to the windshield itself. For this purpose, Seattle Metro has used a modification of a mirror commonly used on recreational vehicles.

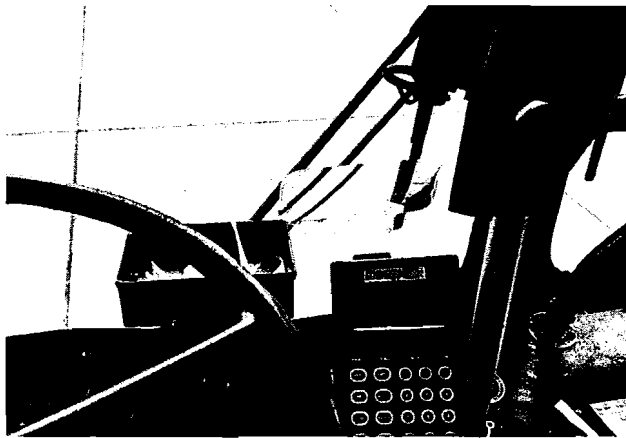

*Seattle Metro attached lenses to bus windshields to improve the field of view in front of the buses.*

## KNEELING BUSES

All of the newer buses are equipped with the kneeling feature. This feature allows the bus driver to lower the height of the right side of the bus. This is accomplished using an air bellow system that is inflated and deflated. The height of the step can be lowered 4 to 8 inches depending upon the bus type. The bumper to road clearance is typically 17 inches. Therefore, the kneeling feature should not cause a front mounted rack to impact the ground when the kneeling feature is used.

---

<sup>61</sup> Metro-Dade Transit, *Metrobus Bus Operator's Manual*, (1994): 48.



## BUS TOWING

All of the MDTA buses are towed from the front of the bus. On standard buses the bus is lifted from the front onto a flat-bed tow truck using cables that go underneath the front of the bus. For a bus that is lift-equipped the cables are attached to tow eyes on the front of the bus so that the bus can be pulled onto the tow truck without damaging lift equipment. Both of these towing methods will require that a front bike rack be removed from the bus prior to towing. It should be emphasized that damage to the bicycle rack could occur if it is not removed prior to towing.

## ROADWAY CHARACTERISTICS

The physical dimensions of roadway intersections and bus stops used by bus routes can be an important consideration when using bicycle racks on buses, in addition to the selection of routes to serve in an initial demonstration program. The issue of adequate space to make right turns at intersections has been expressed as a primary concern.

### Turning Radii

Figures 14 and 15 illustrate the minimum turning path characteristics of design vehicles for both single unit bus and articulated bus classes of vehicles. This includes both the turning radius and the width of the turning path, for which buses have greater minimum requirements than passenger vehicles. A design vehicle represents those of similar weight, dimensions and operating characteristics to those vehicles in its class. Each design vehicle has larger physical dimensions and a larger minimum turning radius than those of almost all vehicles in its class. The principal dimensions affecting the design are the minimum turning radius, the tread width, the wheelbase, and the path of the rear tire on the side of the bus facing the direction of the turn. Minimum turning paths were calculated assuming that the vehicle speed is less than 10 mph.<sup>62</sup> The *Metrobus Bus Operator's Manual* states that no turn shall be made at more than 5 mph.<sup>63</sup>

---

<sup>62</sup> American Association of State Highway and Transportation Officials. *A Policy on Geometric Design of Highways and Streets*. (Washington, D.C., 1990): 19.

<sup>63</sup> Metro-Dade Transit. *Metrobus Bus Operator's Manual*. 1994. p. 70. The Manual also gives instructions for the proper execution of right and left turns.

Right turns should be made from the traffic lane as near to the right hand curb as possible. Do not swing wide enough for an automobile to get on your right side. Adequate room should be allowed when making a right turn so that the right rear wheel of the bus does not ride the curb, nor the right side of the bus scrape against poles and fire plugs.

Left hand turns should be made from the traffic lane nearest the center line of the street when possible, or the left lane on one way streets.

Using turning templates from the AASHTO Greenbook, the diagrams illustrating minimum turning radii were modified to include the installation of a bicycle rack along with the path of overhang of the rack. The diagrams that were used include the 40-foot bus as well as the 60-foot articulated bus. These diagrams were chosen because they represent the current MDTA fleet as well as the future possibility of the use of articulated buses. The rack that was used extended three feet beyond the bumper of the bus. This was the largest rack that was included in the analysis.

The outside minimum turning radius of the RTS II is 44 feet and for the Metrobus it is 43 feet 10 inches. Figure 14 shows the turning radius requirements for these buses.

**FIGURE 14: Turning Radius Template for 40-foot Bus with 36" Front Bicycle Rack**

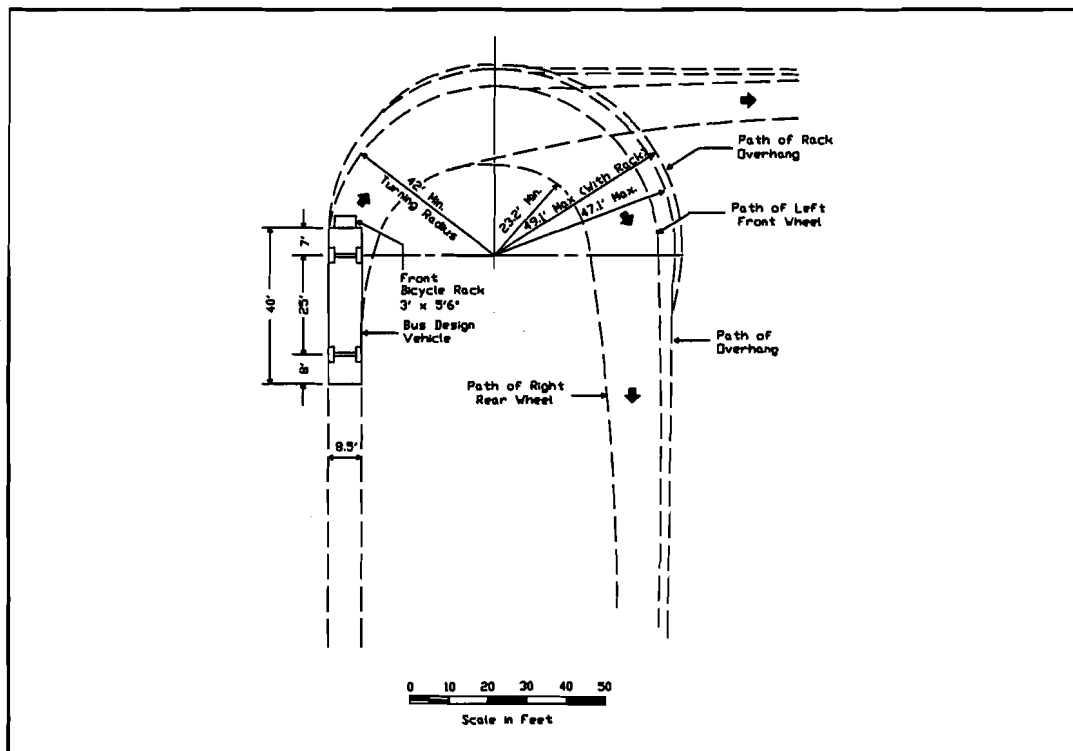

For greater demand responsiveness and efficiency, one bus type to be added is an articulated bus that can have a much higher capacity of passengers. It has the same width and height as the current buses but it is 60 feet long. While the articulated bus is longer, the turning radius of the new buses is expected to be less than the older buses due to the design. The turning radius requirements for this type of bus are shown in Figure 15.

**FIGURE 15: Turning Radius Template for 60-foot Articulated Bus with 36" Front Bicycle Rack**

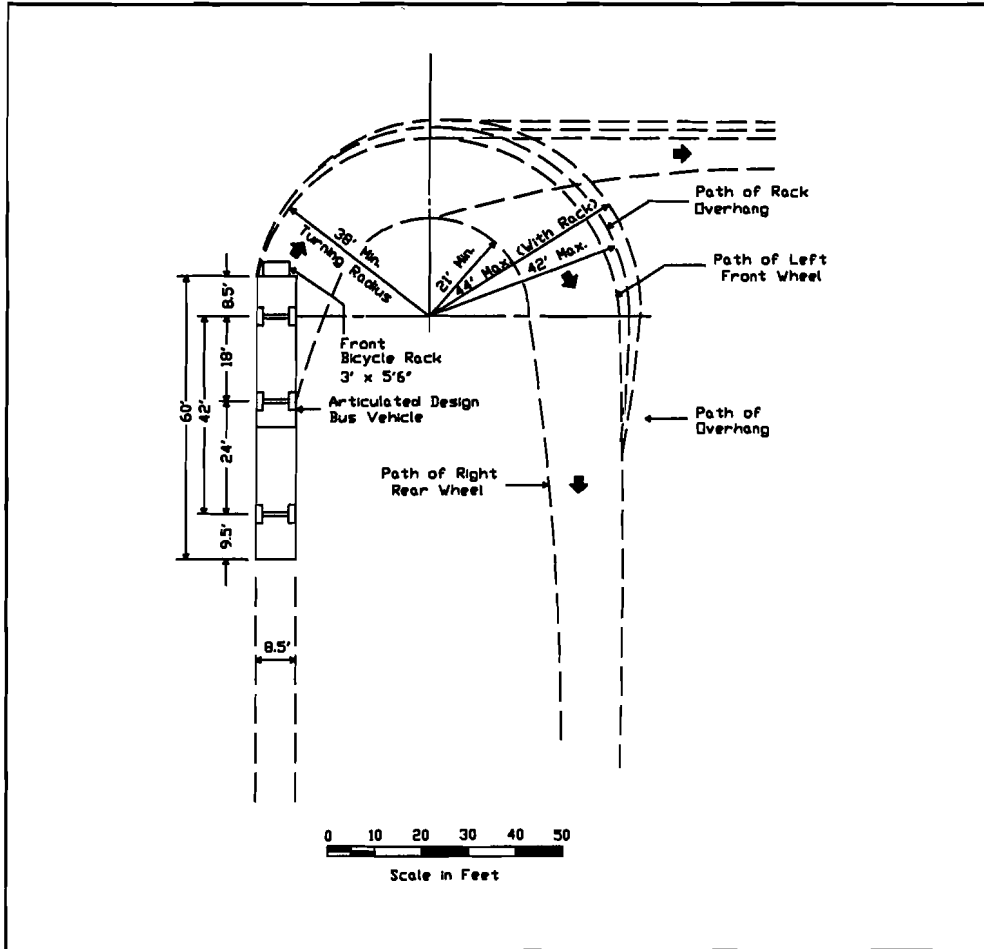

The diagrams specify the minimum required radii if the bus were to make the tightest turn possible. The use of front-mounted bicycle racks requires consideration of the path of the overhang of the left front portion of the bus, particularly as this is altered by the installation of a rack. The addition of this bike rack will cause the bus to require an additional two feet of clearance while making turns greater than 90 degrees. However, during routine bus operation, bus operators usually do not make the sharpest turns possible. Most intersections require a 90-degree turn, for which additional required clearance by a rack-equipped bus is less than two feet.



*Side view of a platform style rack when folded. It extends approximately 6 inches from the front of the bus.*



*In the unfolded position, this rack design extends 27 inches beyond the brackets.*

The overhang of the rack can be reduced by mounting the rack to the right of the center of the bus. Due to the added length to a bus from a front-mounted bicycle rack, buses may have insufficient room for U-turns and right turns where intersections are narrow.

This is a photograph that needs a caption. Three potential trouble spots have been identified for which additional turning room required by a rack-equipped bus should be compared with space provided by the existing facility geometry. In the Dadeland North Metrorail Terminal there is a turn that is enclosed by a wall. This could cause difficulties if the radius of the curve is not large enough. Route 87, an initially selected candidate route for the demonstration program, passes through the Dadeland North Metrorail Terminal.

On NE 35<sup>th</sup> Ave. at 171<sup>st</sup> St. a bus route passes through a cul-de-sac. There is another cul-de-sac on NE 191<sup>st</sup> St. west of NE 14<sup>th</sup> Ave. Routes V, E and H serve these areas but these routes are not included as initially selected route candidates for a bike-on-bus demonstration program. A more comprehensive identification of potential trouble spots can be undertaken as part of a demonstration program, seeking the participation of the bus operators in identifying potential problems. If the bike-on-bus demonstration program were to be adopted as a permanent service and expanded systemwide, the paths of these and other routes will require review.

### **Other Roadway Features**

The majority of bus stops do not have bus bays. Instead, bus stop briefly within the far right lane of moving traffic. Every bus stop is required to have a designation sign. Some stops have shelters or benches, but these are not standard features.

Since the safety of loading and unloading the bicycles is an important consideration, a bus stop in relation to the nearest intersection must be carefully located. If the bus stop precedes the intersection, a bike-on-bus service using front-mounted bicycle racks must ensure enough clearance in front of the bus in order for the bicyclist to safely load/unload a bicycle without entering the intersection. Similarly, a bike-on-bus service using rear-mounted bicycle racks must have enough clearance behind the bus in order for the bicyclist to safely load a bicycle without entering the intersection.

Concern was expressed about the space requirements of buses pulling into bus bays at two new bus transfer facilities. A bus facility has been newly constructed at the Omni station and bus bays were included in the construction of the Brickell Metrorail and Metromover stations, for purposes of truncating CBD-oriented bus routes. The Omni bus terminal consists of ten sawtooth bus bays and the Brickell transfer facility contains five bus bays of similar design in order to allow the bus drivers to pull in and out without having to back up. The bus bays at both Omni and Brickell measure at least 45 feet long where the buses remain when stopped. Ample turning area from the bays is provided. Extending the length of a 40-foot bus an additional three feet for a bicycle rack will not cause maneuvering problems. The bays are long enough that bus operators can park the buses without interference with the present placement of sign stanchions.

There are ten initially selected demonstration route candidates; one route, Route 48, passes through the Brickell metromover station. No initially selected route candidates for the demonstration program pass through the Omni transfer facility.

The Portland Tri-Met and Seattle Metro bike-on-bus services represent programs that provide service to downtown areas where street and intersection geometry may be constricted. It is useful to note that no turning problems have been cited by these two programs. Their experience has shown that field practice by bus operators enables them to successfully compensate for any additional turning room needed.

In some instances, the use of a staggered stop bar at an intersection approach may provide the room necessary to complete a particularly sharp turn. This can be achieved by placing the approach lane stop bars, particularly for those approach lanes closest to the centerline, several additional feet back from the intersection. On low-volume streets, encroachment into adjacent lanes during a turn may not cause problems.

If the MDTA bike-on-bus service were eventually approved for permanent implementation, either systemwide or for designated routes only, coordination with roadway engineers and designers should be pursued to incorporate transit design considerations that accommodate service improvements.<sup>64</sup>

## BICYCLE PARKING

Bus stop amenities, particularly bicycle parking facilities, are an increasingly important element to a bike-on-bus service as ridership increases. While it is anticipated that the newer designs of front-mounted racks holding up to two bicycles will provide sufficient capacity during the start-up phase of a bike-on-bus service, there is the possibility that in some instances, a bicyclist will encounter a fully loaded bicycle rack on the bus that he wishes to board.



*In downtown Portland, bicycle parking is provided along transit routes.*

The bicyclist then has two choices. Many transit agencies with bike-on-bus programs instruct passengers to wait for the next available bus. This would be an unacceptable option to most patrons if bus headways were longer than 15 minutes. A second alternative is for the passenger to leave his bicycle at the bus stop by parking it securely. This is an option only at bus stops where bicycle racks or lockers are provided. This option also compromises the effectiveness of the bike-on-bus service concept because the passenger no longer has use of his bicycle at the destination end of his bus trip.

---

<sup>64</sup> Highway design treatments undergo continual review and many recent publications provide guidelines. For example, a discussion of intersection design for bus turns is presented by Metropolitan Transit Development Board, *Designing for Transit*, 1993 (San Diego, CA): 19-23.

For the above reasons, it is recommended that MDTA seek a vendor who can supply a bicycle rack to hold more than two bicycles for those routes which demonstration program monitoring indicates the demand is greater. Such racks could be used only for those routes requiring greater capacity. The number of bicyclists desiring to board at any time should be closely monitored to identify bus stops where patrons encounter a fully loaded rack.

The second best alternative is to promptly provide bicycle racks at specific bus stops when the need arises. Some bicycle parking already exists. For example, Metrorail stations presently provide a place to lock and leave a bicycle that could be used in the event that the bus arrives with a full rack. The larger Metrorail facilities are equipped with bicycle lockers and the smaller stations have bicycle racks.<sup>65</sup> There are twenty-one Metrorail stations currently in service and all of the stations provide bicycle racks. Fourteen of the stations also provide bicycle lockers. Table 10 lists all of the Metrorail stations and the bus routes that stop at each station. The table also designates the stations that are equipped with bicycle lockers.<sup>66</sup>

Bicycle parking facilities available at bus stops along routes intersecting Metrorail stations would reinforce the bike-on-bus service only for those patrons who are bicycling to that particular bus stop. Therefore, it would be necessary to provide additional secure parking where the demand for the bike-on-bus service exceeds the capacity. As one travels toward major destination centers, the need for bicycle racks at bus stops will tend to increase as the bus fills with passengers. Bicycle racks generally hold from one to 18 bicycles and the cost per rack can range from \$140 to over \$1100. In areas where theft and vandalism is a problem, the provision of bicycle lockers should be considered.

A third option is to shorten the bus headways along these routes during times where the greater demand arises. Programmatically, this may be the most costly option unless it is justified by increased ridership.

A fourth option, especially for routes with lower ridership, is to allow the bus operator to use his discretion to permit bicyclists to bring the bicycle inside the bus. This option has advantages in that it would be the least costly and it would prevent having to turn any passengers away the moment capacity problems began to occur. The disadvantages are the same as those listed in the previous discussion about in-vehicle transport: namely, conflict for space with customers with disabilities, wear and tear on the bus interiors, safety risks, and increased confusion about the rules of the bike-on-bus program. If bicycles can be taken inside buses at certain times, why not at any time? Clearly articulated public information and consistent rule enforcement would be required to ensure that bicycles are transported inside buses only when the bicycle rack is full, the bus passenger compartment has plenty of room to spare, no customers with disabilities require the space and only at the discretion of the bus operator.

---

<sup>65</sup> Susie Laplant, Miami Operations, July 6, 1994, telephone interview.

<sup>66</sup> Jae Manzella, Bicycle/Pedestrian Coordinator for Dade County, November 21, 1994, telephone interview.

**TABLE 10:  
Metrorail Stations And Bus Route Connections**

<b>Metrorail Stations</b>	<b>Available Bicycle Lockers</b>	<b>Bus Routes that Stop at the Station</b>
Okeechobee	Yes	54, 73, 87
Hialeah	Yes	28, 29, 37, 54, L
Tri-rail	No	L
Northside	Yes	12, 21, 32, L
Dr. Martin Luther King Jr.	No	62
Brownsville	Yes	54
Earlington Heights	Yes	17, 22, 95x
Allapattah	Yes	12, 21, 36, J
Santa Clara	Yes	21, 22, 32
Civic Center	No	22, 32, 95x, F
Culmer	No	77
Overtown/Arena	No	2, 7, A
Government Center	No	2, 3, 6, 7, 9, 10, 11, 16, 21, 24, 48, 77, 95x, B, C, K, M, T
Brickell	No	6, B
Vizcaya	Yes	12, 17, 24
Coconut Grove	Yes	
Douglas Road	Yes	37, 40, 42, 48, 65x, J
University	Yes	48, 52, 56
South Miami	Yes	37, 48, 52, 57, 72
Dadeland North	Yes	1, 38x, 71, 87, 88
Dadeland South	Yes	1, 52, 73



## SUMMARY AND RECOMMENDATIONS

This chapter has provided a comprehensive overview of issues relating to the equipment options available for a bike-on-bus service. Existing conditions under which a program would begin were described, including roadway and bus stop characteristics, washing facilities and a description of the existing bus fleet as well as future bus purchasing plans. Bicycle characteristics and methods of transporting bicycles were also described in detail. Bus layout and outside bumper structure were examined due to their potential effect on bike-on-bus service options.

### Target Market Definition

An initial decision that would need to be made by MDTA, prior to the initiation of a bike-on-bus service, is the definition of a targeted market, to be consistent with the service mission of the agency and based upon estimations of demand. This definition will provide a directed focus when making all remaining decisions about the new service, such as the types and sizes of bicycles to be accommodated. It is recommended that the target market include those individuals who ride standard road and hybrid bicycles, including children's bicycles. Considering the design features of bicycle transport equipment currently available, this will accommodate most bicyclists.

### Transport Option Selection

A second decision that would need to be made by MDTA concerns choosing the best transport option. Five bicycle transport options were described in this chapter.

Of the two options considered most effective and feasible (in-vehicle transport and the front-mounted bicycle rack), it is recommended that MDTA begin a demonstration program using front-mounted racks because there are racks on the market that have overcome many original issues of concern. They have been built to performance specifications addressing ease of loading/unloading, weight, compactness, compatibility with wash equipment, and ease of removal.



*Wheelchair compartments of buses are not designed to secure bicycles.*

Although the option of in-vehicle transport requires no new equipment, it creates problems of priority with regard to space available for passengers. Buses of the future may include design accommodations for conveniently transporting bicycles in the passenger compartment, but MDTA's existing fleet is not optimally equipped for such a service. Testing the transport of bicycles inside buses might be useful only for those routes that consistently serve few customers and have plenty of room to spare; however, any savings achieved by purchasing less bicycle racks may be offset by increased maintenance and cleaning of bus interiors, increased inconvenience experienced by regular passengers, and increased confusion and rule enforcement difficulties caused by allowing multiple means of transporting bicycles that differ from one route to the next.

### **Design Considerations**

Several issues were identified with regard to the use of a front-mounted bicycle rack, including:

- capacity of the rack to accommodate anticipated user demand;
- compatibility of rack mounts with bus bumper assemblies;
- visibility of a deployed rack by the bus operator and other motorists;
- access to maintenance hatches;
- adequate turning radii;
- visibility of advertising panels; and
- compatibility with bus washing facilities.

#### *Capacity of the rack to accommodate anticipated user demand*

The most recent styles of front-mounted racks can accommodate two bicycles. Experience of other transit systems has shown that this is sufficient initial capacity for a demonstration program.

#### *Compatibility of rack mounts with bus bumper assemblies*

No problems are anticipated regarding the availability and fabrication of the mounting apparatus to attach bicycle racks to the front bumper assemblies of all existing buses and those currently planned for purchase.

#### *Visibility of a deployed rack by the bus operator and other motorists*

The blind spot from the bus operator's position extends approximately 48 inches beyond the front of the bus. Regardless of the use of a rack, bus operators already drive the bus without being able to see directly in front. Through training and practice, bus operators compensate for lack of visibility by using safe driving techniques. With the use of a bicycle rack, the driving

procedure would be no different. As an extension of normal training and practice, bus operators would learn to safely accommodate the additional maximum of 36 inches that some rack styles extend from the bus when deployed. Depending upon the features of the rack, procedures can be devised to improve safety. For example, one urban transit system instructs bicyclists to load a bicycle into the outer position of the rack first. The outside bicycle is within view of the bus operator, providing a point of reference. Operating procedures such as these, while not necessary for safety, can enhance safety if the procedures are applied consistently. It is also recommended that the bicycle racks be designed to include reflective tape or paint to increase the visibility of the rack to other motorists sharing the road. Enhanced visibility can also be achieved with the placement of additional mirrors.

#### *Access to maintenance hatches*

Maintenance hatches are located on both the front and back of most buses employed by MDTA. The track style rack reviewed in this study weighs 70 lbs. but is positioned low enough on the bus that removal would not be necessary to access the front maintenance hatch. Some platform style racks must be completely removed for maintenance hatch access, but one style reviewed in this report features a modified design that requires removal of the rack securing latch only. Other platform style racks are designed to weigh as little as 28 lbs. so that the rack can be easily removed in order to access the maintenance hatch.

#### *Adequate turning radii*

An examination of additional space requirements needed by buses to complete turns shows that when making the sharpest turn possible, up to two feet of additional space may be required when completing a right turn that is greater than 90 degrees. It is recommended that turning requirements of candidate demonstration routes be reviewed in detail prior to final selection. While the worst potential locations are cul-de-sacs or turns constricted by walls, a review of bike-on-bus programs of experienced transit systems indicates that turning movement problems can be minimized in three ways:

1. Familiarization and training of bus operators so that they know how to compensate for any increased space requirements to safely complete a turn;
2. The use of a staggered stop bar for particularly narrow intersections; and
3. Positioning the front-mounted rack slightly to the right of center of the bus.

### *Visibility of advertising panels*

Advertising panels on the front, sides and back of buses provide additional revenues to MDTA. Consultation with the advertising contractor indicates that sales from advertising on the front panels of buses never approach 90 percent of the existing space. As a result, the use of front-mounted racks for purposes of a bike-on-bus demonstration program utilizing less than 10 percent of buses in the fleet, should not adversely affect revenues from bus panel advertising. Some impact may occur if the demonstration program is applied systemwide. It is recommended that this impact be quantified in greater detail prior to systemwide implementation.

### *Compatibility with bus washing facilities*

A final concern relates to bicycle transport equipment compatibility with the MDTA bus washing facility. All rack designs reviewed for this study are designed to remain on the buses during the wash procedure without causing damage to the wash facility or to the racks.

### *Performance Specifications*

As it relates to the selection of the most appropriate equipment and technologies to implement a bike-on-bus demonstration program, it is emphasized that the Seattle Metro case study is particularly informative in the manner in which they selected an equipment supplier. Seattle Metro used the competitive bidding process to their advantage by seeking a vendor who would supply a product that met their performance requirements. It is recommended that MDTA consider a similar equipment acquisition process, in which the available technology is changed and advanced to meet the specific needs of MDTA, rather than MDTA tailoring a bike-on-bus service to fit the constraints of available rack designs.

MDTA would need to carefully consider their performance specifications. It is recommended that MDTA pursue a rack design that can transport more than two bicycles for routes where demand exceeds service capacity. The performance requirements of Seattle Metro are contained in this report to be used as a suggested starting point.

### *Technologies of the Future*

While it is recommended that the front-mounted rack option be tested as part of a demonstration program, one final thought is added concerning the design of buses to accommodate a bike-on-bus service. The design of buses evolve to meet the changing needs of the traveling public. For example, recent bus design changes to use alternative fuels happened in response to the need to reduce pollution and energy consumption. Likewise, low-floor buses are being introduced to improve bus accessibility to all. Their introduction in Canada and the United States has been successful. Low-floor buses feature ramps instead of lifts, making it easier for patrons in

wheelchairs to enter and exit the bus. The low-floor feature makes it easier for everyone, including seniors, children and other persons with disabilities, to safely board and exit the bus.<sup>67</sup> It would also be easy for bicyclists to board and exit low-floor buses with their bicycles. While low-floor buses are not specifically designed to accommodate bike-in-bus service, these new buses may have advantages for this purpose. If MDTA were to consider the use of low-floor transit buses in the future, the bike-in-bus option should be reconsidered.

To accommodate the transport of bicycles, attaching racks to the outside of buses might be considered a design afterthought. If urban areas discover that their bike-in-bus programs become an increasingly demanded service, then ideally the bicycle-carrying features will be incorporated into future bus designs. This might take the form of a special bicycle compartment accessed from within or outside the bus. Such a capability may be a useful criterion as part of future bus purchasing considerations.

---

<sup>67</sup>Transportation Research Board, National Research Council. TCRP Synthesis 2. *Low-Floor Transit Buses* (Washington, D.C.): 1994.



## PROGRAMMATIC NEEDS

### SELECTING PROGRAM OBJECTIVES AND TARGET MARKETS

Initial decisions in the development of any new transportation service include identifying program objectives and target markets. Table 11 below describes two possible approaches for a bike-on-bus service. One approach represented in the first category describes service targeted to three main types of discretionary bus riders, the second category describes transit-dependent bus riders.

It is more likely that the bike-on-bus program would achieve greater success targeting service to transit-dependent persons because the advantages gained, including greater mobility and access, are more compelling than those gained by persons with other travel options. The target market composed of motorists, proficient bicyclists who can travel long distances and existing bus passengers who walk to and from the bus stop, might use the bike-on-bus program if they were convinced they would save time and money. It can likely be proven that many motorists would save money by using bike-on-bus transit service; however, saving time is usually the deciding factor. A bike-on-bus service would not necessarily be faster for a proficient bicyclist who can ride in excess of 15 mph, especially if there were a long wait at the bus stop. In addition, the bike-on-bus option would cost the bicyclist bus fare.

**TABLE 11: MDTA Bike-On-Bus  
Program Planning Approach Options**

TARGET MARKETS	OBJECTIVE	PERCEIVED BENEFITS	RESULTS
Motorists	Replace auto trips with bike-on-bus travel	Time and money savings	<ul style="list-style-type: none"> <li>• Mode shift toward increased use of transit</li> <li>• New customers</li> </ul>
Proficient bicyclists	Replace long distance bike trips with bike-on-bus travel	Time savings in exchange for bus fare	
Existing bus passengers	Replace walking trips to bus stop with bike-on-bus travel	Time savings	<ul style="list-style-type: none"> <li>• Increased customer satisfaction</li> </ul>
Transit-dependent persons and persons living beyond transit service area	Enable transit-dependent persons to reach more destinations  Make Metrobus service accessible to more people	Improved mobility and access	<ul style="list-style-type: none"> <li>• Increased trip making</li> <li>• New customers</li> <li>• Increased customer satisfaction</li> </ul>

It is possible that motorists and proficient bicyclists would use the bike-on-bus program as bus service frequency along bus routes continues to improve and time spent waiting at the bus stop decreases. It is suggested that these potential customers should be considered as a long term objective for a bike-on-bus program. It is recommended that MDTA target the transit-dependent as part of a short term objective for a demonstration program.

## **SELECTING OPERATIONAL GOALS**

Operational goals of a properly designed demonstration program include integrating the new service into the existing transit operations, and minimizing disruption to normal routines while ultimately developing improved customer service. A properly designed bike-on-bus program should:

- enhance mobility of the ridership;
- increase customer satisfaction;
- stay on schedule;
- maximize safety and convenience; and
- provide a level of service that is cost effective.

Metrobus patrons expect to travel on schedule, in safety and comfort. These are prime considerations when identifying operational considerations. This chapter addresses several topics, including safety and risk management, systematic inspection and maintenance, accident documentation and analysis, liability, funding, and the creation of a bike-on-bus program team.

Physical and programmatic needs for an MDTA bike-on-bus program are discussed in this chapter in the context of an assumed use of front-mounted bicycle racks.

### **Safety and Risk Management**

Minimizing safety hazards is a primary consideration to establishing any new service. The MDTA System Safety Program Plan (SSPP), revised July 1992, specifies requirements for the conduct of system safety tasks. These are carried out with the oversight of the MDTA Transit Safety and Assurance Division.

The identification of safety considerations in this study began with a detailed review of federal and state requirements, as they might apply to the establishment of a bike-on-bus service. Chapter 14-90 of the Laws of Florida, entitled "Equipment and Operational Standards Governing Public-Sector Bus Transit Systems," specifies requirements for system safety program planning, transit vehicle specifications, the physical design of transit support facilities, maintenance and inspection, training and testing, accident documentation and notification, recordkeeping, driver fitness and operational requirements, and standards for accessible buses. There is no prohibition



or restriction against allowing bicycles to be carried either inside a public bus or upon a rack mounted to the bus.

### **Systematic Inspection and Maintenance**

Chapter 14-90.004(4), entitled "Bus Transit System Operational Standards," requires that all buses operated and all parts and accessories on buses that may affect safety of operation are regularly and systematically inspected, maintained and lubricated at a minimum in accordance with the standards developed and established in the SSPP to ensure they are in safe and proper operating condition. With the exception of bus tire servicing, all maintenance activities of buses are conducted by MDTA. Personnel conduct routine maintenance, repair, and pre-departure inspections that are guided by preventive maintenance practices recommended by the vehicle manufacturers. Daily inspection cards are filled out and a maintenance history is compiled on computer file for each vehicle. Chapter 14-90.004(4)(b) requires specification of the type of inspection, maintenance and lubrication interval to be performed on each bus based upon mileage or time interval. Chapter 14-90.004(4)(d) specifies how maintenance records must be maintained.

A bicycle rack should be considered as an additional accessory of the bus; therefore, it is recommended that MDTA request recommendations on maintenance and lubrication from the rack manufacturer, and incorporate such recommendations into existing inspection procedures. It is recommended that bicycle rack maintenance procedures be added to the documentation by date, mileage, and type of inspection, maintenance and lubrication or repair performed, in accordance with the law.

This might be accomplished similar to the manner in which wheelchair lift equipment is inspected. An inspection form entitled "Wheelchair Lift Preventive Maintenance Inspection Order, 6000 Miles" outlines a nine-step process for checking the operability of the wheelchair lift, with space for identifying the bus, the mechanic conducting the inspection, the supervisor and space to note any defects detected. This same format could be used for devising a detailed step-by-step inspection of the bicycle rack equipment at the recommended mileage interval. Figure 16 is a copy of the wheelchair lift inspection form.

Another MDTA inspection form, the "Metrobus Maintenance Flexible 6000 "A" Inspection" form, revised 03/01/94, provides a checklist for all major bus systems for each vehicle. The final miscellaneous category, entitled "Safety," which lists eleven checkpoints, could be revised to include a twelfth item, the bicycle rack. Figure 17 duplicates this inspection form.

The law lists all parts required to be inspected, including equipment for transporting wheelchairs. It is recommended that MDTA extend this list to include a daily inspection of the bicycle rack to ensure that it remains securely mounted to the bumper, that all moving parts and safety devices work properly, and that the bicycle securing mechanism is in good working order to ensure that bicycles will not fall off the bus while in motion. The "Metrobus Operator's Pre-Trip Inspection," Form No. 405.01-24, Revised 5/93, could be amended to include a pre-departure

FIGURE 16: Wheelchair Lift Inspection Form

**CENTRAL O & I**

**WHEELCHAIR LIFT PREVENTIVE MAINTENANCE INSPECTION ORDER**  
**6,000 MILES**

BUS NO. \_\_\_\_\_ PM LEVEL: \_\_\_\_\_

REPAIR ORDER NUMBER IF OTHER THAN PM : \_\_\_\_\_

\_\_\_\_\_ 1. Remove covers and clean with compressed air

- A. Power platform.
- B. Hinges and hinge barrier.
- C. Lift master and slave chains.
- D. Slide channels.

\_\_\_\_\_ 2. Check tension on all chains.

\_\_\_\_\_ 3. Check all hoses for leaks, including transfer pump.

\_\_\_\_\_ 4. Check lift mounting bolts and clevis pins.

\_\_\_\_\_ 5. Inspect lift locking latch.

\_\_\_\_\_ 6. Open electrical box under platform, inspect all electrical connections, clean and lubricate.

\_\_\_\_\_ 7. Grease and lubricate the following:

- A. All chains.
- B. Ramp barrier links.
- C. Ramp barrier clevis pins & linkage.
- D. Main lift cylinder anchor pins.
- E. Stow or locking latch pivot.
- F. Bridge/barrier clevis pins & pivot pins.
- G. Slide Channels.

\_\_\_\_\_ 8. Check safety features:

- A. sensitive edges.
- B. Sensitive mat.

\_\_\_\_\_ 9. Cycle wheelchair lift twice, if everything works reinstall all covers.

**NOTE ALL DEFECTS**

\_\_\_\_\_  
\_\_\_\_\_  
\_\_\_\_\_

MECHANIC \_\_\_\_\_ BADGE NUMBER \_\_\_\_\_

SUPERVISOR \_\_\_\_\_ DATE SIGNFI \_\_\_\_\_

# FIGURE 17: Metrobus Maintenance Form

METROBUS MAINTENANCE  
FLXIBLE  
6,000 "A" INSPECTION

M E T R O - D A D E  
T R A N S I T

Miles 'til due \_\_\_\_\_  
Avg miles/day \_\_\_\_\_  
As of (date) \_\_\_\_\_

**TO BE FILLED OUT BY OFFICE**

BUS NUMBER \_\_\_\_\_  
Mileage Inspection Due \_\_\_\_\_

**TO BE FILLED OUT BY MECHANIC**

Mechanic's Name \_\_\_\_\_ Badge # \_\_\_\_\_  
Hub Miles \_\_\_\_\_ Oil Sample Taken  
Engine No. \_\_\_\_\_ Yes \_\_\_\_\_ No \_\_\_\_\_  
Transmission No. \_\_\_\_\_ Yes \_\_\_\_\_ No \_\_\_\_\_

**TO BE FILLED OUT BY CONTROL ROOM**

Date Assigned \_\_\_\_\_  
Date Completed \_\_\_\_\_  
Mileage Completed \_\_\_\_\_  
Transfer Supervisor \_\_\_\_\_

**Legend**

= OK       = Needs Repairs

**I. AIR SYSTEM**

- A. Electrical - Check low air tell-tale
- B. Mechanical - Check and report condition of the air compressor:
- 1. Governor - out in and out range (IN 90 psi and OUT 120 psi)
  - 2. Check low air pressure interlock

**II. BRAKE SYSTEM**

- A. Electrical - check and repair, as required, the following lights:
- 1. Stop lights
  - 2. Tell-tale, stop light
  - 3. Tell-tale, parking brake
  - 4. Deceleration lights

**III. CHARGING SYSTEM**

- A. Electrical - Check 12V and 24V alternators:
- 1. 12V output
  - 2. 24V output
  - 3. Check Anderson plug: loose? cracked?
- B. Mechanical - Check and report condition of 12V alternator:
- 1. Belt
  - 2. Belt tension - specification 100 lbs.
- and 24V alternator:
- 3. Bolt
  - 4. Belt tension - specification 300 lbs.

**IV. COOLING SYSTEM**

- A. Hydraulic - Pressurize cooling system (9 psi), remove engine access cover (beneath rear passenger seat) and check the following components:
- 1. Marine pump
  - 2. All lines
  - 3. All hoses
  - 4. Radiator

**V. ENGINE CONTROL SYSTEM**

- A. Electrical - Report condition and operation of the following:
- 1. Engine low oil tell tale
  - 2. Engine overheat tell tale
  - 3. Engine alarm stat
  - 4. Dash and control panel switches and gauges.
  - 5. Engine motor guard shutdown switches.
- B. Hydraulic - Change the following
- 1. Primary and secondary fuel filter
  - 2. Engine oil filters
  - 3. Engine oil
- B-2 Also check:
- 1. Transmission fluid level
  - 2. Differential oil level
  - 3. Drive-shaft u-joint play-rotate - 180°

**B-3 Start engine and leak check:**

- 1. Engine oil
- 2. Engine coolant
- 3. Transmission fluid
- 4. Power steering fluid

**D. Pneumatic - Replace air filter**

- 1. Reset restriction indicator.

**VI. ENTRANCE DOOR SYSTEM**

- A. Electrical - Check operation of the following:
- 1. All front door lights
  - 2. Door open switch
- B. Pneumatic - Check operation of the following:
- 1. Door opening speed
  - 2. Door closing speed
  - 3. Cushioning adjustment
  - 4. (Door open) Brake/accelerator interlock

**VII. EXIT DOOR SYSTEM**

- A. Electrical - Check operation of the following:
- 1. All rear door lights
  - 2. By pass switch - 7000 only
- B. Pneumatic
- 1. Opening speed
  - 2. Closing speed
  - 3. Cushioning adjustment
  - 4. Emergency release

**VIII. LUBRICATION POINTS**

- 1. Differential drive - shaft u - joints
- 2. Transmission load transmitter (lithium white) grease.
- 3. Steering:
  - A. Steering shaft U and slip joint
  - B. Drag line ends
  - C. Tie rod ends
  - D. King - pin knuckle
  - E. Transfer box input shaft
  - F. Steering column slip joint and U joint
  - G. Steering gear box input and output shaft.

**IX. SAFETY**

- A. Miscellaneous - Check condition and operation the following:
- 1. Horn/steering wheel/column play
  - 2. All interior lights
  - 3. All exterior lights
  - 4. Drivers seat belt, anchor bolts and adjustability.
  - 5. Interior and exterior glass (windows, doors, and mirrors) and body damage
  - 6. Passenger seats, stanchions, grab rails.
  - 7. Emergency doors, hatches and safety decals ( destination sign door latch and chain)
  - 8. Standee line and warning decal.
  - 9. Triangle flare kit
  - 10. Fire extinguisher
  - 11. Wheel chair tie - down equipment

bicycle rack inspection within that portion of the routine during which the bus operator walks around the outside of the bus. Figure 18 is a copy of the pre-trip inspection form.

Chapter 14-90.006(7), "Operational and Driving Requirements," specifies that bus operators must submit a daily written report indicating the condition of the bus and listing all defects and deficiencies likely to affect safe operation or cause mechanical malfunction. MDTA provides for this with the use of the Operator's Defective Coach Report. This form could be used to report operational problems and defects of the bicycle racks.

### **Accident Documentation and Analysis**

Chapter 14-90.005, entitled "Transit Bus Accidents," requires transit systems to conduct comprehensive evaluations and maintain recordkeeping on all accidents involving a public bus. Accidents and related insurance claims are initially minimized through proper training, inspection, maintenance and repair, as discussed above. Accident analysis is also a vital part of the program.

MDTA managers submit incident reports, which are used to identify corrective actions and to reconstruct accidents as part of the legal defense of the County. However, a proactive approach to anticipate hazards and take corrective action before accidents occur is a primary component of MDTA's SSPP.

MDTA uses a System Safety Engineering Methodology of the FTA criteria document MIL-STD-882B, entitled "System Safety Program Plan Requirements," which has been adopted by FDOT. The purpose of the methodology is to systematically identify, analyze and minimize hazardous conditions. Both inductive and deductive methods of hazard analysis are used. Inductive methods identify a failure condition, then determine the impacts upon the system and upon personnel, resulting from the failure. Deductive methods start with identifying a hazardous outcome, then deducing what kinds and combinations of failure conditions could cause such outcomes. Transit Safety uses the experience of other transit systems in these hazard identification methods. The SSPP identifies and describes the application of four types of inductive hazard analyses. These are:

- Preliminary Hazard Analysis;
- Subsystem Hazard Analyses;
- Operating Hazard Analysis; and
- Detailed hazard Analysis.

A Fault Tree Analysis is identified as a deductive method used.

It is recommended that the Transit Safety and Assurance Division consider using some of these methods during the development and conduct of a bike-on-bus demonstration program. For example, a Preliminary Hazard Analysis could be conducted in order to develop safety requirements that become the basis of performance specifications for a preferred front-mounted

FIGURE 18: Metrobus Operator's Pre-Trip Inspection

**BUS OPERATOR'S MANUAL**  
**METROBUS OPERATOR'S**  
**PRE-TRIP INSPECTION**  
 Front side — Form No. 405.01-24 (Rev. 5/93)



**METROBUS OPERATOR'S**  
**PRE-TRIP INSPECTION**

**BUS NUMBER:** \_\_\_\_\_

**DATE** \_\_\_\_/\_\_\_\_/\_\_\_\_

**ENTERING BUS:**

0	O.K.	1	METER	2	BRAB	3	RAILS	4	STLP	5	DER.	6	EDGE	7	LATCHES	C
---	------	---	-------	---	------	---	-------	---	------	---	------	---	------	---	---------	---

0	O.K.	1	FIRE	2	EXTIN-	3	GUINER	4	TELL	5	TAIL	6	LIGHT	7	SUN	8	VISION	9	SAFETY	10	TRAMBLE	11	KIT	12	EMERG.	13	HATCH	D
---	------	---	------	---	--------	---	--------	---	------	---	------	---	-------	---	-----	---	--------	---	--------	----	---------	----	-----	----	--------	----	-------	---

**SIT IN SEAT...START BUS:**

0	O.K.	1	BROKEN	2	WIND-	3	SHIELD	4	FARE	5	BOX	6	LIGHT	7	BATTERY	8	RADIO	9	HORN	E
---	------	---	--------	---	-------	---	--------	---	------	---	-----	---	-------	---	---------	---	-------	---	------	---

**WALK BACK THROUGH BUS:**

0	O.K.	1	FLOOR	2	AND	3	SEATS	4	SIDE	5	WINDOWS	6	DOOR	7	GLASS	8	DOOR	9	LIGHTS	10	SIDE	11	SIGN	F
---	------	---	-------	---	-----	---	-------	---	------	---	---------	---	------	---	-------	---	------	---	--------	----	------	----	------	---

**WALK AROUND BUS:**

0	O.K.	1	FRONT	2	ROLLER	3	SAFETY	4	AIR	5	LEAKS	6	FLAT	7	TIRE	8	WORN	9	TIRES	10	WHEELS	11	LUGS	G
---	------	---	-------	---	--------	---	--------	---	-----	---	-------	---	------	---	------	---	------	---	-------	----	--------	----	------	---

0	O.K.	1	OPEN	2	COMPART-	3	MENTS	4	OIL	5	WATER	6	LEAKS	7	MIRRORS	H
---	------	---	------	---	----------	---	-------	---	-----	---	-------	---	-------	---	---------	---

0	O.K.	1	HEAD	2	LIGHTS	3	BURNING	4	WINDOWS	5	BRAKE	6	LIGHTS	7	HARKER	8	LIGHTS	9	TAIL	10	LIGHTS	I
---	------	---	------	---	--------	---	---------	---	---------	---	-------	---	--------	---	--------	---	--------	---	------	----	--------	---

**IN DRIVER'S SEAT:**

0	O.K.	1	DOORS	2	WORKING	3	AIR	4	PRESSURE	5	WIND-	6	SHIELD	7	WIPERS	8	DOOR	9	CONTROL	J
---	------	---	-------	---	---------	---	-----	---	----------	---	-------	---	--------	---	--------	---	------	---	---------	---

0	O.K.	1	DOOR	2	WATER-	3	LOCK	4	TIPT	5	STEERING	6	WHEEL	7	BRAKES	8	(SOFT)	9	BRAKES	10	(GRAB)	11	(PULL)	12	TURN	13	SIGNAL	K
---	------	---	------	---	--------	---	------	---	------	---	----------	---	-------	---	--------	---	--------	---	--------	----	--------	----	--------	----	------	----	--------	---

0	O.K.	1	HAZARD	2	SIGNAL	3	SEAT	4	BELT	5	CYCLE	6	WHEELCHAIR	7	LIFT	8	L
---	------	---	--------	---	--------	---	------	---	------	---	-------	---	------------	---	------	---	---

0	O.K.	1	PARKING	2	BRAKES	3	STEERING	4	HARD	5	STEERING	6	LOOSE	7	DEFROST	8	PASS.	9	BUEZZER	M
---	------	---	---------	---	--------	---	----------	---	------	---	----------	---	-------	---	---------	---	-------	---	---------	---

0	O.K.	1	FUMES	2	OR	3	ODORS	4	CLIMATE	5	CONTROL	6	TRANSM.	7	NOISY	8	TRANSM.	9	WONT	10	SHIFT	11	WHEELCHAIR	12	TIE	13	DOWN	N
---	------	---	-------	---	----	---	-------	---	---------	---	---------	---	---------	---	-------	---	---------	---	------	----	-------	----	------------	----	-----	----	------	---

**DEFECT? X OUT APPROPRIATE SQUARES.**  
**NO DEFECTS? X OUT "O.K." SQUARES.**  
**TURN THIS FORM INTO GUARD BEFORE LEAVING GARAGE.**

**DEFECTS WITHIN HEAVY BLACK**  
**SQUARES MUST BE TAKEN TO HOT LINE**

**CIRCLE ITEMS CORRECTED ON "HOT LINE"**

405.01-24 500

rack design. An Operating Hazard Analysis could be applied for the purpose of developing operational safety requirements for the installation and maintenance of the racks by MDTA personnel and for the use of the racks by passengers.

If a hazardous condition is identified, the Transit Safety and Assurance Division also may want to conduct a risk assessment to estimate severity of the potential occurrence and the probable frequency of the occurrence, to determine the degree of accepted tolerance of the hazard relative to the cost to reduce it.

Identifying performance specifications for a front-mounted rack design, as recommended in the previous section, would provide the opportunity for the Transit Safety and Assurance Division first to design for minimum risk. Secondly, Transit Safety could request that the rack manufacturer incorporate safety devices into the rack design to reduce remaining hazards to an acceptable level as defined by the MDTA Risk Assessment Criteria. Thirdly, the development of rack installation, maintenance and repair procedures, rack loading/unloading procedures, and training curricula to teach proper conduct of these procedures to MDTA personnel and to bus passengers will further reduce hazards not completely eliminated by the rack design.

### **Liability**

MDTA coordinates with the Risk Management Division of the Metro-Dade County General Services Administration, to maintain and administer self-insured programs. Risk management was an issue discussed while interviewing program managers of other transit systems that offer bike-on-bus service. Questions were asked relating to any changes in insurance rates due to the bike-on-bus service, accident rates and the incidence of theft, the number and dollar amount of claims filed and actions taken to diminish exposure to risk.

In the experience of the Phoenix Bike-on-Bus program, no incidents involving injury or major damage have occurred to the bicycles, buses, personnel or customers since the beginning of the Bike-on-Bus service. One theft was reported, but it was the result of the bicyclist not communicating to the bus operator that he needed to unload his bicycle after exiting. The bus operator drove away and another passenger stole the bicycle.

Portland Tri-Met is self-insured and treats liability for the bicycle the same as any other possession. There have been four incidents since the Bikes on Tri-Met program began over two years ago. Each incident involved a bicycle falling off the rack. One individual asked to be reimbursed for the cost of needed bicycle repairs, which Tri-Met provided. Since establishing Bikes on Tri-Met, insurance rates have not increased.

The Bikes on Tri-Met program currently requires all participants to sign a waiver of liability when they apply for a permit. Tri-Met's legal department maintains that the waiver of liability form provides no legal protection whatsoever and should be eliminated. It is believed that it actually invites litigation by generating the idea for potential litigants. Tri-Met is considering

doing away with the waiver as well as the permitting process in the future. Figure 19 is a copy of Tri-Met's liability waiver.

It is recommended that MDTA prohibit bus operators from helping to load or unload bicycles from racks. The bicycle rack is initially designed and constructed for ease of loading and unloading safely. If a customer is athletic enough to ride a bicycle, it is reasonable to expect him to load and unload his bicycle without aid. This expectation must be made clear in all instructional literature prepared for the public. An adult accompanying a child bicyclist must be responsible for securing the child's bicycle to the rack. This prohibition against bus operator involvement eliminates any risk of bus operator injury and associated workman's compensation claims due to lifting. It also eliminates the necessity for the bus operator to park the bus and leave the driver's seat, which would cause delay and interfere with attendance to other boarding passengers.

The single largest issue to bus operators of other transit agencies has been displeasure at the prospect of loading bicycles. The above recommendation addresses this concern. There also appears to be no restrictions in the current labor agreement with the Transport Workers Union (TWU) that would prevent the bike-on-bus concept from moving forward. MDTA and TWU are presently in the first year of a three-year agreement, such that present planning for a bike-on-bus service should not interfere with other collective bargaining issues.

## **PROGRAM COSTS**

Very little information is available regarding the costs of bike-on-bus program development, training, and rack installation, inspection and maintenance. The bike-on-bus programs featured as case studies did not have detailed accounting available of the cumulative time requirements for implementing the service. The TCRP survey of programs indicated that while new staff were not hired to implement the bike-on-bus programs, existing staff found that they were spending 10-20 percent of their time for program administration. Maintenance managers were spending 5-10 percent of their time on bike-on-bus programs.<sup>68</sup> Program development and organizational activities prior to the start of the demonstration program may require between six and 18 months.

It is apparent that the cost of bike-on-bus programs vary widely, depending upon the size of the transit system, the number of routes served by the program and features, such as training and marketing materials. This makes programs difficult to compare. For example, Phoenix's six-month demonstration program cost \$17,655, not including personnel training and staff time. Broward County estimated that it would cost \$250,000 for systemwide implementation, including the purchase of bicycle racks for 200 buses.

---

<sup>68</sup> Transportation Research Board, "Integration of Bicycles and Transit," *TCRP Synthesis 4* (Washington, D.C.) 1994.

**FIGURE 19: Bikes on Tri-Met Liability Form**



TRI-COUNTY METROPOLITAN TRANSPORTATION  
DISTRICT OF OREGON (TRI-MET)

**BIKES ON TRI-MET PROGRAM**

**RELEASE OF LIABILITY AND INDEMNIFICATION**

**Release:**

I understand that it is a privilege, not a right, to bring a bicycle on a Tri-Met vehicle and that I do so at my own risk. I hereby release Tri-Met, its directors, officers, representatives, agents and employees from any and all liability for injury to me or said bicycle or other property I may have with me, incurred by reason of any act or omission, either by me, a third party, or by Tri-Met, its directors, officers, representatives, agents or employees, and connected with the presence of the bicycle on Tri-Met operated property. I waive all claims of injury to me or damage to the bicycle and other property connected with the bicycle on a Tri-Met vehicle.

**Indemnification:**

I recognize that a bicycle aboard a transit vehicle poses a potential hazard to me and other transit patrons in the event of sudden stop, acceleration, collision, fire or other emergency. I agree to indemnify, hold harmless and defend Tri-Met, its directors, officers, representatives, agents and employees from all costs, damage, attorney fees or expenses, direct or indirect, for injury to other persons and their property, incurred by reason of any negligent act or failure to act on my part, in connection with the presence of said bicycle on Tri-Met property. I recognize that this provision makes me personally liable for injuries to Tri-Met patrons and employees and for damage to property arising by reason of negligent use of the bicycle on Tri-Met trains or buses.

I expressly agree that the foregoing release, waiver, and indemnity agreement is intended to be as broad and inclusive as is permitted by the law of the State of Oregon and if any portion thereof is held invalid, it is agreed that the balance shall, notwithstanding, continue in full legal force and effect.

**I HAVE READ THIS RELEASE OF LIABILITY AND AGREEMENT TO INDEMNIFY, DEFEND AND HOLD HARMLESS, AND FULLY UNDERSTAND THE SIGNIFICANCE OF BOTH. I AGREE TO BE BOUND BY THE PROVISIONS OF BOTH IN RETURN FOR TRI-MET GRANTING ME PERMISSION TO BRING A BICYCLE ON ITS TRANSIT VEHICLES WHILE RIDING AS A PASSENGER.**

\_\_\_\_\_  
Signature of Permittee

\_\_\_\_\_  
Date

\_\_\_\_\_  
Signature of Legal Guardian  
(if Permittee is under age 16)

\_\_\_\_\_  
Relationship of Legal Guardian to Permittee



Fees can help defray some of the costs of a program. For example, Portland Tri-Met charges \$7.50 per month for bicycle locker rentals. Other programs charge \$3.00 to \$5.00 for the price of a bike-on-bus permit, although such fees rarely cover the costs of program administration. It was not found in any of the case studies that patrons had to pay a higher fare to have their bicycles transported by bus. Bicycles are treated as any other permitted possessions carried by passengers. While this may be a means to generate some revenue, it is recommended that MDTA offer the bike-on-bus service at the same fare or discount fare for which customers are otherwise eligible, in order to encourage customers to try the service.

It is anticipated that the hourly labor expenses of bus operators will be a primary program cost of a demonstration program. It is estimated that it will require the training of approximately three to four times more bus operators than the number of buses equipped with bicycle racks.

**TABLE 12:  
Number of Bicycle Racks Required**

<b>Recommended Route Number</b>	<b>Number of Weekday Peak Vehicles Required</b>	<b>20% Spare Factor</b>
73	7	2
48	3	1
35/70	7	2
Total	17	5

Table 12 above shows that it will be necessary to equip about 22 buses with bicycle racks. Limiting the number of buses with bicycle racks is achievable since buses are assigned to specific routes. However, there should be a 20 percent spare factor to allow for routine maintenance and accidents that will remove equipped buses from service.

This means that initial training of approximately 66 to 88 bus operators would be required. If the Portland Tri-Met example is used, initial bus operator training for a bike-on-bus program would consist of one hour of classroom training, including a video presentation, and one hour of on-road practice. The training would be given to groups of five or six bus operators. This is roughly equivalent to 176 hours of training time for the bus operators and 36 hours of time spent by trainers. Because periodic line-ups change the garage facility assignments of approximately 25 percent of the bus operators, then periodic initial training would also be required, including an additional 44 hours of training time per line-up and an additional 8 hours of trainers' time. Applying salary rates, hourly wages and overtime rates to these figures can supply rough estimations of training cost.

Training of maintenance personnel will also be required after the initial procurement of the racks. Maintenance staff will be required to learn how to assemble, mount, remove, inspect, maintain and repair the bicycle racks. The racks themselves are supposed to require very little maintenance, according to the manufacturers surveyed for this study. The time required of maintenance personnel would be equivalent to the number of routine maintenance inspections per year based upon the mileage accumulated for each equipped bus. For example, Portland Tri-Met schedules rack inspections for every 1,500 to 2,000 miles driven per bus. A complete inspection takes approximately 15 minutes. Also, time will be spent installing and removing the rack, each time a maintenance hatch must be accessed. Manufacturers estimate that removal takes less than ten minutes. This will depend greatly upon the rack design; some racks only require partial removal.

As part of a pre-departure inspection, bus operators would also require time to ensure that the bicycle rack is operable.

The cost of the bicycle racks and mounting assemblies produced by the manufacturers surveyed for this study range from \$450 to \$689 each, as of September, 1994. The purchase of 22 racks would range from \$10,000 to \$15,200. Bus stop amenities, including the cost of bicycle racks, may cost as much as \$1100 for a single rack built to hold 18 bicycles. However, it is possible that at many bus stop locations, a rack built to hold a single bicycle and costing \$140 would suffice.

At a minimum, these are the major program elements that will require funding.

- Salaried and hourly labor
- Equipment
  - bicycle racks
  - mounting brackets
  - spare parts
  - additional mirrors
  - bus stop bicycle storage
  - bus stop signage
- Marketing materials
- Instructional materials

#### **FUNDING OPPORTUNITIES FOR THE BIKE-ON-BUS PROGRAM**

Funds are now increasingly available for bike-on-bus programs, particularly as they can be related to air quality projects. A state DOT air quality demonstration grant of \$10,000 paid for Phoenix's in-house development and installation of 47 racks serving three demonstration routes. Program

administration and operations funding came from the city. Federal transit funds and a local match funded the program beyond the demonstration.

Many programs are now receiving federal CMAQ funding to pay for bike-on-bus equipment. For example, HARTline obtained \$100,000 of CMAQ funding for FY 1993 to equip its entire fleet of 170 buses with front-mounted racks, install the racks and to cover the cost of training their bus operators. Seattle received \$950,000 in federal CMAQ funding, combined with a \$237,000 match from Metro to implement their bike-on-bus program systemwide.

### **Surface Transportation Program**

The federal Intermodal Surface Transportation Efficiency Act (ISTEA) of 1991 has enabled states and MPOs to fund a wide range of transportation projects, including bicycle projects, for the purpose of developing a more multimodal system. There are several funding sources within ISTEA that offer funding possibilities for a bike-on-bus demonstration program. ISTEA requires a 20 percent state/local match.<sup>69</sup>

The Surface Transportation Program (STP) funds of ISTEA may be used for bicycle facility development in addition to funding the creation of marketing and instructional materials. There are few limitations on the use of these funds and they have been already used by other urban areas for bicycle lanes, bicycle parking, education and safety programs.

### *Transportation Enhancement Activities*<sup>70</sup>

Ten percent of each State's annual STP funds are available for Transportation Enhancement Activities (TEAs). Bicycle projects are included among the ten TEAs. Enhancement funds can be used to link existing facilities and help complete a comprehensive system. If the MDTA bike-on-bus program were identified as a mobility enhancement project, it is possible that funding for expenses such as permitting and promotions could be paid for with federal ISTEA funds from the Transportation Enhancement section of the Surface Transportation Program.

An application (Form No. 525-030-30) for enhancement funds can be obtained from the FDOT district office. Figure 20 is a copy of this form. A designated contact person with the district office receives the application and answers questions regarding the application process. The District 6 office does not have its own set of instructions regarding the application for

---

<sup>69</sup> USDOT, Federal Highway Administration, "Bicycle and Pedestrian Planning Under ISTEA, Participant Workbook," Publication No. FHWA-HI-94-028. June, 1994.

<sup>70</sup> FDOT District VII - Tampa "1994 Transportation Enhancement Workshop." Manual. 1994.

## FIGURE 20: Application for Enhancement Projects

STATE OF FLORIDA DEPARTMENT OF TRANSPORTATION  
**APPLICATION FOR TRANSPORTATION  
ENHANCEMENT PROJECTS**

FORM 525-030-30  
ENVIRONMENTAL MANAGEMENT  
03/94  
Page 1 of 2

Name of Applicant: \_\_\_\_\_ Project Name: \_\_\_\_\_

Submitted by: DOT/MPO/County  
(circle as appropriate)

Priority \_\_\_\_\_ (relative to other applications submitted  
by the Applicant).

Project Sponsor (municipal, county, state, or federal agency):  
\_\_\_\_\_

Contact \_\_\_\_\_ Title \_\_\_\_\_

Address \_\_\_\_\_

Phone \_\_\_\_\_ FAX \_\_\_\_\_

### 1. Qualifying Activities:

Check one or more categories under which the project qualifies as an enhancement activity: (NOTE: Checking all categories possible does not ensure eligibility. Each activity checked must meet all criteria listed for that activity in Appendix B of FDOT Procedure #525-030-300-c).

- Provision of facilities for pedestrians and bicycles. (See I of Appendix B)
- Acquisition of scenic easements and scenic or historic sites. (See II of Appendix B)
- Scenic or historic highway programs. (See III of Appendix B)
- Landscaping and other scenic beautification. (See IV of Appendix B)
- Historic preservation. (See V of Appendix B)
- Rehabilitation and operation of historic transportation buildings, structures or facilities (including historic railroad facilities and canals). (See VI of Appendix B)
- Preservation of abandoned railway corridors (including the conversion and use thereof for pedestrian or bicycle trails). (See VII of Appendix B)
- Control and removal of outdoor advertising. (See VIII of Appendix B)
- Archaeological planning and research. (See IX of Appendix B)
- Mitigation of water pollution due to highway runoff. (See X of Appendix B)

IF NECESSARY, USE ADDITIONAL SHEETS TO RESPOND TO THE FOLLOWING:

### 2. Project Description:

- (a) What type of project is being proposed?
- (b) Describe the direct relationship of the project to the intermodal transportation system relative to function, proximity or impact. (One or more may apply).
- (c) Where is the project located (and what are the termini, if appropriate)?
- (d) Summarize any special characteristics of project.

## FIGURE 20: Application for Enhancement Projects (cont'd.)

FORM 525-030-30  
ENVIRONMENTAL MANAGEMENT  
03/94  
Page 2 of 2

- (e) Explain the project's relationship to federally or state owned property or other publicly owned property (if applicable).
- (f) What need will the project address?
- (g) What is the status of the project (i.e. under design, plans on shelf, not begun, to be initiated, etc.)?
- (h) What work has been performed to date and by whom?
- (i) What work is expected to be performed?

### 3. Selection Criteria:

Attach documentation as exhibits to this form.

- (a) If it is proposed that the project be administered by a governmental entity other than the state, document that this entity has the fiscal, managerial, environmental and engineering capabilities to manage the project consistent with federal requirements.
- (b) Document public (and private, if applicable) support of the proposed project. (Examples include: written endorsement, formal declaration, resolution, financial donations or other appropriate means).
- (c) Document proposed project has met all eligibility criteria for each activity marked on the front of this form (See Appendix B).

### 4. Project Cost:

What is the estimated total cost of the project and how will it be funded?

Federal \$ \_\_\_\_\_ + State \$ \_\_\_\_\_ + Local \$ \_\_\_\_\_ = Total \$ \_\_\_\_\_

Federal \_\_\_\_\_ % + State \_\_\_\_\_ % + Local \_\_\_\_\_ % = 100%  
(cannot exceed 80%)

### CERTIFICATION OF PROJECT SPONSOR

I hereby certify that the proposed enhancement project herein described is supported by \_\_\_\_\_  
(municipal, county, state or federal agency)  
and that said entity is willing to: (1) provide the required funding match; (2) enter into a maintenance agreement with the Florida Department of Transportation; and/or (3) support other actions necessary to fully implement the proposed project.

\_\_\_\_\_  
Signature

\_\_\_\_\_  
Name (please type or print)

\_\_\_\_\_  
Title

RECYCLED PAPER 

enhancement funds. The schedule for processing the applications is established by the state and District 6 follows that schedule.

The application is submitted to the MPO and the County Commission. The MPO then submits the application to the appropriate district office for an eligibility assessment. Eligibility for enhancement funds is determined if the proposed project has a direct relationship to the intermodal transportation system developed under ISTEA, based upon function, proximity and impact.

There are specific criteria for bicycle facilities in order to receive enhancement funds, some of which are listed below.

- The facilities must be available and accessible to the general public.
- A written commitment from a public agency must be included in the application for the maintenance and operation of the qualifying bicycle facility.
- The bicycle facility must be supported by a local or regional plan where applicable.
- The bicycle facility must meet the most recently approved federal and state planning and design requirements.

Once eligibility is determined, the FDOT district office would return the application to the MPO and the County Commission. The MPO and the County Commission are then required to notify the district office and the project sponsor of the initial priority rankings of all eligible projects. If the project rates highly, then the project sponsor submits a project prospectus (Form 525-010-30) to the MPO and the County Commission. The MPO and the County Commission submit to the district office the project prospectus and the final priority rankings as part of the Transportation Improvement Program. FDOT then develops the Tentative Work Program after receipt of TIPs and project prospecti statewide. The FDOT Work Program would list those projects approved for receipt of funds.

### **Congestion Mitigation and Air Quality Improvement Program**

The Congestion Mitigation and Air Quality (CMAQ) Program of ISTEA provides funds for a variety of projects that reduce vehicle emissions, improve air quality and help to attain the National Ambient Air Quality Standards (NAAQS) for ozone, carbon monoxide and other emissions.<sup>71</sup> Bike-on-bus programs in other urban areas have received CMAQ funds. The first step to obtaining CMAQ funding is to have the bike-on-bus project included in the MPO TIP.

---

<sup>71</sup> USDOT, Federal Highway Administration, "Guide to the Congestion Mitigation and Air Quality Improvement Program." Publication No. FHWA-PD-94-008. 1993.

The CMAQ application must include an evaluation of the emissions reduction potential of the bike-on-bus demonstration program.

While the airshed that includes Dade County had previously been designated as nonattainment for ozone, the airshed will be officially designated an attainment area for the NAAQS, effective April 25, 1995. It will be listed as a maintenance area and must maintain controls to ensure that the standards are not exceeded in the future. Under the present law, achievement of attainment status would render the area ineligible for CMAQ funding. However, a bill presently before Congress, known as the National Highway System Bill, would enable former nonattainment areas to continue receiving the same amount of CMAQ funds. If the bill is passed, then the Miami Urbanized Area could continue to receive CMAQ funds. If the bill does not pass, there is some possibility that the state will provide funding from other sources to make up for the loss of previous funding.

### **State Level Transportation Finance and Planning**

State funds can also be used to match federal shares for the cost of projects. Monies from the State Transportation Trust Fund is the departmental fund from which the cost of state highway and public transportation projects are funded. It can be used to match federal funds. FDOT may provide 100 percent of the nonfederal share of a transit project or transit-related project that is funded under the CMAQ Attainment Program.

It is helpful to briefly describe transportation finance and planning processes of Florida. The Florida Transportation Plan (FTP) provides long range goals to guide the provision of transportation facilities and services statewide as well as the process for developing the system. It emphasizes interconnectivity, multimodalism, including bicycle transportation, the optimization of existing facilities, the enhancement of public transit, and the consideration of social, economic, energy and environmental effects. A bike-on-bus demonstration program is consistent with all of these concepts.

The FDOT 5-year work program is developed based upon the policy guidance of the FTP. The State Transportation Improvement Program (STIP) is developed to be consistent with the FTP and contains projects that are eligible for federal or state funding. It is a prioritized combination of projects developed from aggregating the Transportation Improvement Programs of all the state's MPOs, according to criteria contained in Chapter 339 F.S. It includes projects located in air quality nonattainment areas which conform to the state implementation plan developed pursuant to the federal Clean Air Act.

A bike-on-bus demonstration program could be eligible for federal funding, such as CMAQ funds, especially if it can be demonstrated to reduce ozone. Therefore, including the bike-on-bus program into the MPO TIP and subsequently the STIP should be a goal to consider.

The MPO is responsible for developing the local TIP and for initiating federally aided transportation facilities, including transit facilities that can be funded from the State Transportation Trust Fund. Projects included in the TIP must be consistent with local comprehensive plans.<sup>72</sup> The review of local comprehensive planning in Dade County, as contained in Appendix A of this study, has determined that a bike-on-bus program would be judged consistent.

The MPO TIP is submitted to the FDOT District Secretary, each member of the State Legislature who represents the MPO area, and the Department of Community Affairs prior to review by the Florida Transportation Commission and the Governor's Office. In order for federal or state funding to be appropriated to the bike-on-bus demonstration project, it must be accepted for inclusion into the approved work program of the state.

Three other funding opportunities may be available at the state level for funding all or some of the costs of a bike-on-bus demonstration program. These programs include Transit Corridor Projects, the Public Transit Block Grant Program and the Intermodal Development Program.

The Intermodal Development Program is created within the FDOT to provide for major capital investments to facilitate the intermodal or multimodal movement of people and goods. The Public Transit Block Grant Program provides funds for Section 9 and Section 18 providers, for funding the costs of public bus transit capital projects and the costs of public bus transit service development and transit corridor projects.

A third option is the transit corridor project. As defined by state statute, a transit corridor project is that undertaken by a public agency for the purpose of relieving congestion and improving capacity within an identified transportation corridor. This is accomplished by increasing the people-carrying capacity of the system through the use of high-occupancy vehicle conveyances. A transit corridor project must be identified as part of the planned improvements on the transportation corridor designated by FDOT. A transit corridor project must be documented by FDOT to include project objectives, assigned operational and financial responsibilities, the timeframe required to develop the service and the criteria by which the success of the project will be judged.<sup>73</sup> FDOT is authorized to fund up to 100 percent of the capital and net operating costs of transit corridor projects.

---

<sup>72</sup> Refer to 339.135, F.S., "Work program, legislative budget request...", 339.155, F.S., "Transportation planning," and 339.175, F.S., "Metropolitan planning organization."

<sup>73</sup> Refer to 341.031, F.S., "Definitions," and 341.051-053, F.S., "Administration and financing of public transit programs. See also 341.052, F.S., "Public transit block grant programs," and 341.053, F.S., "Intermodal Development Program."



## **BIKE-ON-BUS PROGRAM TEAM**

According to the Tri-Met program manager in Portland, team work and the input from advisory groups cannot be overemphasized in planning a bike-on-bus program. Advice given by Metro staff in Seattle is to include "devil's advocates" on the team, to identify multiple sides of the issues. If the service is supposed to target a specific customer group, get a representative on the committee. For example, Creole and Spanish speaking representatives should be included. Seattle Metro had enlisted the help of several committees, such as the Citizens Transit Advisory Committee, the Elderly/Handicapped Transit Advisory Committee, and the Bicycle Task Force.

It is recommended that MDTA assemble a working team to develop, organize, implement and evaluate the demonstration program. Team participants should include at a minimum, MDTA departmental representatives from:

- Bus Operations;
- Bus Maintenance;
- Safety;
- Facilities Maintenance;
- Materials Management;
- Technical and Special Projects;
- Transit Systems Development;
- Service Planning and Scheduling;
- Public Services;
- Marketing/Communications;
- Leasing and Joint Development; and
- Deputy Director.

Other participants should include representatives from:

- Metro-Dade Planning Department;
- Bicycle/Pedestrian Advisory Committee, including its MPO staff member;
- Citizens Transportation Advisory Committee; and
- Spanish and Creole speaking communities and other identified markets not otherwise represented by program team membership.

MDTA may also wish to involve other representatives as they see fit. These might include:

- Selected MDTA bus operators and maintenance personnel; and
- MDTA Union-Management Safety Committee representatives.

A successful approach of the Seattle Metro program leadership was to provide drafts of policies and operating procedures for the demonstration program, distributed in advance for the task force to evaluate. Meetings were scheduled later to discuss the issues and make modifications based on consensus.

## SUMMARY

This section on programmatic needs identifies several considerations for establishing a bike-on-bus program. Recommendations are summarized as follows.

- Bike-on-bus demonstration program objectives and target markets should be selected as part of initial program planning.
- The rack acquisition process provides an ideal opportunity to identify rack performance specifications to design for minimum risk.
- The MDTA Transit Safety and Assurance Division should consider conducting a Preliminary Hazard Analysis in order to develop safety requirements as a basis for rack performance specifications. The conduct of an Operating Hazard Analysis should be considered to develop operational safety requirements for rack installation, maintenance and use.
- The bicycle rack should be included in routine maintenance and pre-departure inspections.
- To reduce liability, bus operators should be strongly discouraged or prohibited from physically loading and unloading bicycles from the rack. Clear instructions should be provided to the public describing safe loading and securement procedures.
- Federal ISTEA funding sources should be investigated for the bike-on-bus program, including funding from the Congestion Mitigation and Air Quality program and Transportation Enhancement Activities of the Surface Transportation program.
- A bike-on-bus program team should be established, comprised of MDTA staff and community representatives.

## **PUBLIC INFORMATION**

There are two main purposes that a public information program can serve in the development of a bike-on-bus program. The first purpose is to provide information to build awareness about the program by new bike-on-bus customers, regular passengers and the general public. The second purpose is to provide instruction about the proper use of the service.

### **PUBLIC AWARENESS**

First, the public needs to know the purpose of a bike-on-bus service, how it works and how it can help them. They need to know where the service is available and where it can take them. They need to know who is eligible to use the service and how much it costs. They also need to know what to do in order to avail themselves of the service. It is important to clearly communicate all hours of service and any restrictions. Because many new customers may not have much previous bicycling experience, it is vital to provide bicycle traffic safety information and rules of the road in addition to tips on how to dress for safety and comfort, how to pack clothes, books and other items, and how to fix the occasional flat tire.

Basic information is commonly relayed through the use of eye-catching brochures, decals and posters with tear-off cards. Existing materials, such as bus schedules and the Dade County Transit Map, can be revised at their next scheduled updates, to include information about the bike-on-bus program. A multi-lingual prerecorded telephone message played while MDTA customers are placed on hold, can introduce the availability of bike-on-bus service.

Planners of the Phoenix Bike-on-Bus Program found that the most effective means by which customers learned of the service were by newspaper announcements, a bike-on-bus brochure and by simply seeing the rack on the bus and receiving information by talking to the bus operator. Phoenix distributed 18,500 brochures during their demonstration program, representing 3.35 brochures per bike rack user.

Information dissemination is aided by strategic placement of written materials where people gather, wait, relax or stop by for information. Such locations include but are not limited to:

- bus passenger compartments, bus stops and stations;
- park and mall kiosks;
- social service offices;
- public libraries;
- courthouse;
- driver license offices;
- traffic school;
- bicycle shops; and
- college campus student unions.

Organizations can also help to distribute information. These include the bicycle advisory committee, bicycle clubs, environmental organizations, homeowner associations, the regional commuter assistance program and local transportation management organizations (TMOs). As new TMOs are now being developed in Dade County, these organizations can be especially effective in relaying information to area employers about the new service.

Timing the program to open after the hot summer season has passed, or to coincide with a holiday or other events, such as the beginning of a school session, Earth Day or National Bike to Work Week, may increase chances of press coverage and maximize trial-use participation. A kick-off event for the bike-on-bus service, such as that staged by Hillsborough Area Regional Transit, coincided with the opening of a transit store in downtown Tampa. A kick-off event can serve as a central focus for local TV news, radio and newspaper coverage. Figure 21 illustrates HARTline's kick-off event.

**FIGURE 21: HARTline's Kick-Off Event**

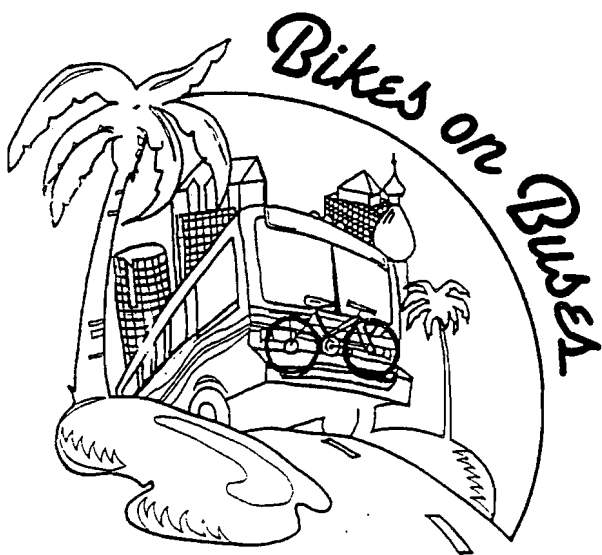

*Downtown Commuter  
Center*

The Hillsborough Area Regional Transit Authority (HARTline) invites you to celebrate the kick-off of its Bikes on Buses Program and the Grand Opening of the Downtown Commuter Center.



Please join us Tuesday, February 14, 1995  
12 Noon

**Downtown Commuter Center**  
**409 E. Kennedy Blvd.**  
(corner of Marion Street and Kennedy Blvd.)

Consideration of a special bike-on-bus program name by MDTA marketing specialists may bolster the ease and effectiveness of the advertising campaign and enhance service image.

As the bike-on-bus project team identifies their target markets, informational materials can be tailored to that particular group. For example, brochures prepared for a readership of high school students may emphasize different points, based upon their particular needs.

Seattle, Washington is similar to Dade County, Florida, in that it serves as a gateway into the United States from other countries. English is not a first language for many residents. Seattle Metro publishes their bus route schedules in seven languages. Because many individuals from other countries also do not have driver licenses and work in low-paying jobs, they are especially in need of transit service. Bicycling is a more common travel mode in many countries and these new residents may be less hesitant to use a bicycle for transportation. As a result, MDTA should consider printing brochures in the languages spoken by identified communities in Dade County.

### **BIKE-ON-BUS INSTRUCTION**

The second purpose of a public information program is instruction on the rules and procedures of the bike-on-bus service. Some programs emphasize simplicity of customer use, by providing easy-to-read brochures or even pictograph instructions on the front bus panel or bicycle rack. Other programs require permitting.

In exchange for receiving information and demonstrating one's knowledge of the rules, a customer may receive a permit for the privilege of using the service. Some programs, as described in detail in the case studies, require watching a video, physically demonstrating the use of the bicycle rack, and signing a form that indicates comprehension of the rules and waiver of liability for any property damage or injury. Although some planners are concerned that requiring permitting may discourage individuals from using the service, a permitting process provides a chance to communicate procedures, reinforce safety principles, promote public confidence and enforce an age restriction if there is one.

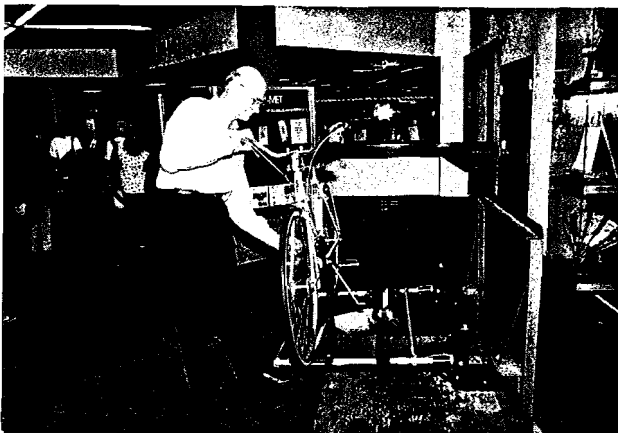

*A customer service specialist of Portland Tri-Met demonstrates hands-on training at the Tri-Met transit store.*

Age requirements for use of bike-on-bus service vary among different programs. For example, Portland Tri-Met issues a regular bike-on-bus permit to passengers of age 16 and older. A youth permit is issued to passengers of ages 8 through 15, who also must be accompanied by someone of age 18 or older with a regular permit. The Seattle Metro and Phoenix programs impose no age limits on the use of their bike-on-bus services. Other programs limit use of the service to passengers of age 18 and over.

It is recommended that MDTA allow passengers of age 16 and older to use a bike-on-bus service unaccompanied. It is reasonable to assume that an individual of age 16 and older will be able to load and unload a bicycle from the rack unaided. This would also enable senior high school students to use the service for school and work transportation. Passengers younger than 16 should be permitted to use the service if accompanied by an adult.

The following provides a recommended step-by-step procedure for a bicyclist to follow when loading a bicycle and boarding the bus. At a minimum, it is recommended to develop written instructions for the customers. Seattle Metro's brochure was included in the case studies. HARTline provides another example as part of Appendix F.

### **Recommended Bike-on-Bus Boarding Procedure Bicyclist's Perspective**

#### *Bicycle Loading and Passenger Boarding*

1. When you see your bus approaching the bus stop, make sure you are completely out of the road and onto the sidewalk. Be prepared to board immediately. Lock the pedals together to prevent theft.
2. If the rack is already full, you must wait either for the next bus or park the bicycle at the bus stop and board without it. Remember to securely lock your bicycle to a bicycle parking rack.
3. As the bus comes to a complete stop, make eye contact with the bus operator. Present your bike-on-bus permit. If you have a youth permit, you may board only if accompanied by an adult (over age 18) with a regular permit.
4. Proceed into the road and toward the bike rack only after the bus operator has motioned to you to proceed.
5. Unfold the rack, then load and secure your bicycle onto the rack while other passengers are boarding. If there is a choice of positions on the rack, load your bicycle into the position farthest from the bus.

6. The bus operator will not load your bicycle onto the rack for you. If you are having difficulty, you may ask for verbal instructions from the bus operator.
7. If you are with another bicyclist who has a youth permit, you are responsible for ensuring that the bicycle is loaded upon the rack properly.
8. When you board the bus, let the operator know where you intend to deboard.

#### *Passenger Deboarding and Bicycle Unloading*

1. Indicate your desire to exit the bus as the bus approaches your stop. Exit through the front door and tell the bus operator that you are going to unload your bicycle from the rack.
2. Remove your bicycle from the rack.
3. Fold the rack up to the closed position if there are no other bicycles on the rack.
4. Move directly to the sidewalk and wait there until the bus has completely cleared the bus stop.

#### **Coordination with Metrorail Bike on Train Service**

It would be advantageous to coordinate the bike-on-bus demonstration program with the existing Bike on Train program, currently available on Metrorail. The Transit Information Center in Government Center Station in Downtown Miami issues Bike on Train permits to bicyclists who pass a brief test on rules of the program. The permit is a laminated picture ID.

Some rules of the Bike on Train program can be transferable to a bike-on-bus demonstration program to promote consistency. For example, the Bike on Train program requires that while waiting at the platform, bicyclists should remain near the benches out of the way of pedestrian travel. Similarly, requiring such courtesy from bicyclists toward pedestrians at bus stops would promote a better service. Five other Bike on Train procedures are listed below, where program consistency could be promoted.

- The bicyclist using the Bike on Train service must be 16 years old or older to be eligible for a permit. However, children under 16 may also obtain a permit but it can only be used when they are accompanied by an adult that also has a permit.
- Bike on Train customers must have their permits affixed to the exterior of their clothing at all times while on Metrorail property.

- When a Bike on Train permit is issued, the bicyclist must sign a waiver releasing Metro-Dade of any liability for injury, loss or damage that may have occurred. The waiver must be co-signed by a parent or guardian if the applicant is under 18 years of age. If a bicyclist fails to abide by the program rules and regulations the issued permit will be revoked.
- Issued permits are not be transferable.
- Bicycles must not be left unattended at any time while on transit property unless properly and securely parked where racks are provided.

## **SUMMARY**

The role of public information in the success of a bike-on-bus demonstration program cannot be overemphasized. Public information serves the dual purpose of creating awareness about the program and of providing instruction for the safe and effective use of the new service. This section has suggested the use of several information tools that have been effectively used by other bike-on-bus programs nationwide. Advantageous locations for placement of information and organizations that may help to publicize the program have been listed. Strategic timing of the program kick-off may yield publicity benefits if coordinated with seasonal events. A carefully selected bike-on-bus program name can boost recognition of the program by the public. Based upon the selected target markets, promotional materials should be produced in the languages spoken by identified Dade County communities.

A bike-on-bus permitting program offers several benefits for providing instruction to the public. It would be advantageous to coordinate any such training with the existing Bike on Train program to promote rule consistency. A recommended boarding procedure from the perspective of the bicyclist is included in this section.



## **PERSONNEL TRAINING**

### **PLANNING STAFF AND MANAGERS**

A major issue cited repeatedly by planners representing other bike-on-bus programs is the need to develop interest and support for the demonstration by the transit personnel who will be operating the new program and interacting with the customers. A demonstration can flounder without the cooperation of staff, especially if a lack of enthusiasm is conveyed to the public. Experienced demonstration program planners have emphasized the importance of strong leadership from top management for a successful program and acceptance by operational staff. Carefully designed training curricula can promote the needed interest and support.

Training curricula should be developed after all policy, equipment and procedural decisions are made. For example, once a bicycle rack prototype has been refined and selected for testing as part of a demonstration program, planning staff and managers participating on the bike-on-bus project team would have the specific information needed for fine-tuning training programs for MDTA staff.

### **CUSTOMER SERVICE REPRESENTATIVES**

Customer service representatives of the Public Services Division need to be familiar enough with the program to explain the service benefits to customers. They must be able to give information about how to obtain instructions and a permit, if a permitting program were established. These representatives may have one of the hardest jobs of all to keep abreast of bike-on-bus service availability as the routes become equipped. This job will be easier if buses serving the selected routes are equipped all at once.

An orientation session, explaining the bike-on-bus service concept would provide customer service representatives with the information necessary to relay the benefits of the program to customers. As bicyclist instructional training and permitting processes are developed, it would be advantageous to test these processes through participation by the customer service representatives. These representatives can give useful feedback about aspects of the training that need clarification. Having been through the training themselves, they would also be in a better position to provide the needed information to customers.

### **BUS OPERATOR TRAINING**

The attitude of the bus operator toward the bike-on-bus program may also heavily influence the receptiveness of bus transit customers toward bike-on-bus service. In this respect, it is important that the training of bus operators not begin after all decisions have been made, but that they begin receiving information about the bike-on-bus demonstration as soon as development of the

program is underway. Successful programs have found that enlisting the involvement of bus operators in the program development process tends to replace resistance with problem solving behavior and the desire to make the program work.

For example, Portland Tri-Met invited bus operators who were also avid bicyclists, to participate in procedural development by providing the perspective and concerns of the bus operators. Seattle Metro invited interested bus operators to test drive buses equipped with bicycle rack prototypes. During off-peak hours, a few bus operators were also stationed at demonstration booths set up for the public to test load the racks with bicycles. In this way, the operators were able to observe people learning to use the rack and they had the opportunity to provide suggestions for improving the procedures and the rack design itself.

Because the general attitudes of MDTA personnel, particularly those of the bus operators, toward the bike-on-bus demonstration program is a major factor in program success, it is vital to foster support. A training program that begins with informational bulletins and later opportunities for participation can lay the groundwork for a spirit of cooperation that will make subsequent training proceed smoothly and successfully.

Chapter 14-90.004(3)(c) of the Laws of Florida requires bus transit systems to establish driver training and testing to demonstrate an employee's capabilities to safely operate each different type of bus before driving on a highway unsupervised. Driver training and testing must include explicit instruction and procedures regarding operational and driving requirements, defensive driving, equipment inspection and handling of emergencies.

The MDTA Transit Safety and Assurance Division reviews and approves training curricula and tests. Records are kept of training provided to personnel. In accordance with the law, it is recommended that the current program of bus operator training incorporate instruction in the safe and proper use of bicycle racks.

The law requires transit systems to provide written operational and safety procedures. Transit systems also must establish driver training for operation of special equipment on buses. Instructional details are contingent upon the specific rack design ultimately selected by MDTA but several recommendations for personnel training are discussed in the next section. Instructions should include:

- operating the bus while the rack is both folded up (not in use) and folded down while carrying bicycles;
- operating the bus through right and left turns, cul-de-sacs, bus stops, into and out of bus bays at bus transfer stations and in queues;
- folding and unfolding the rack;
- loading and unloading a bicycle upon the rack;
- conducting pre-departure inspection;
- securing the bicycle with the fastening device(s);
- communicating with bike-on-bus patrons;

- providing information and instruction to bike-on-bus patrons; and
- following procedures in the event that the rack malfunctions.

Illustrations, photographs and diagrams are useful for showing rack construction. Corresponding slides can aid classroom discussion. Video instruction has advantages for showing moving parts of the rack, bus operation scenarios and illustrative dialogue with customers.

Such training should be provided to all bus operators prior to driving those routes that offer the bike-on-bus service. A stand-alone instruction module should be developed as a training supplement and administered to experienced bus operators who drive routes that are selected for the demonstration program. The bike-on-bus training should also be incorporated into the initial training of newly hired bus operators in addition to refresher training courses.

The law requires evaluation to include a road test of sufficient duration to enable the examiner to evaluate the operator's skill at handling the bus and associated equipment. The road test must be administered by a transit system representative who is qualified to make evaluations. MDTA training staff must be thoroughly familiar with the operation of the bicycle rack, the operation of buses equipped with racks and all aspects of program procedures prior to training and testing bus operators.

The law requires the transit system to maintain a current record of the different types of buses and special equipment each driver is capable of driving and operating. Such notation should include completion of training in operation of buses with bicycle racks.

An initial planning concept for implementing a bike-on-bus demonstration program called for selecting demonstration routes that are all served by buses and assigned operators from just one garage facility. This would make the conduct of bus operator training more efficient. However, approximately 25 percent of MDTA bus operators are reassigned to a different garage facility during line-ups, in which bus operators can apply for reassignment to more preferred routes. This may require the scheduling of subsequent training sessions for reassigned bus operators who will operate routes with the bike-on-bus service.

It is vital that bus operators have a thorough understanding of the established rules and procedures of a bike-on-bus program. Passengers depend upon the bus operator for clarification of program rules to ensure safe travel. This is especially important during the start-up of a new program, when passengers may be confused about proper procedure or may want to test the flexibility of the rules.

Of all MDTA staff, the bus operator has the greatest contact with the bus passengers. The operator oversees the loading and unloading of bicycles from the rack. This procedure is perhaps the most crucial one of the entire program. The development of such a procedure can benefit from the experience of other transit programs. Figure 22 is a copy of the instructional booklet prepared for Seattle Metro bus operators.

## Operator's Manual for

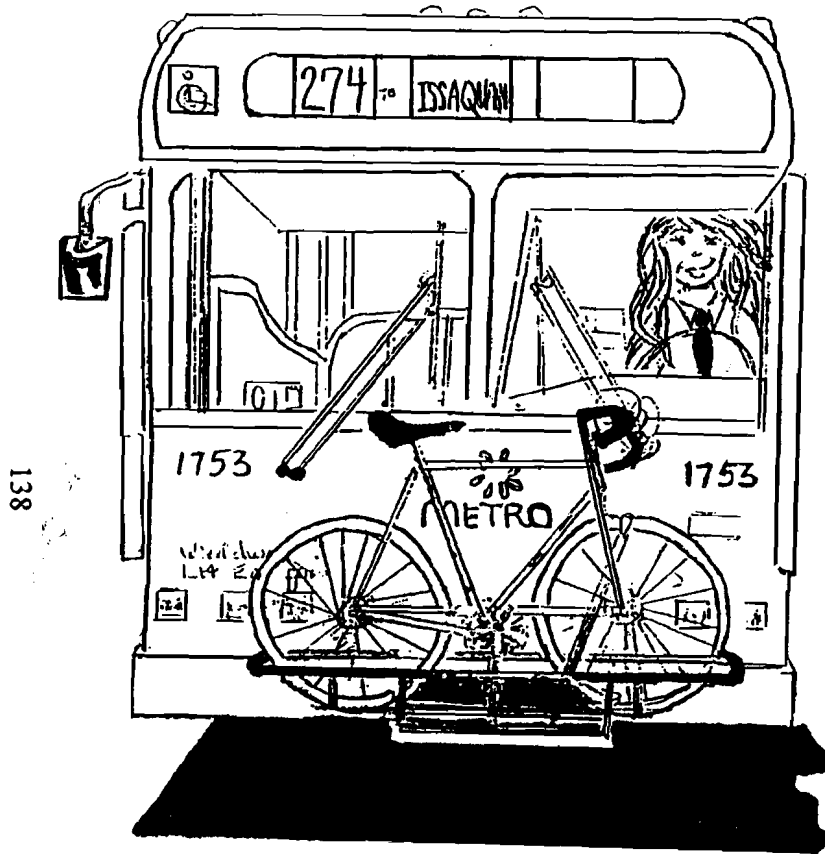

## Metro's Bike and Ride Service



April 1994

Artwork: S. Annette Bishop

### Metro's Bike and Ride Service

Metro has installed bicycle racks on all its coaches to make bike and ride service more accessible to our transit customers. The combination of a new, user-friendly bike rack and simple, straightforward operating policies will enhance Metro's ability to provide a much needed service in the Puget Sound area. You the operator will provide the key to the success of the bike and ride program - safety and service to all our customers.

### Bike and Ride Policies and Procedures

- Bike and ride service is available on all Metro bus routes and trips. No additional fare is required for the bike.
- Customers may load and unload bikes at any Metro bus zone except within the Ride Free Area from 6:00 a.m. to 7:00 p.m. During these hours loading and unloading in the RFA is restricted to a route's first and last ride free stop. In most cases this will be a RFA boundary stop, but be aware that some express routes have their first or last stop inside the RFA. Designated tunnel stops for bike and ride service are Convention Place and International District Stations. When the RFA is closed, cyclists may use any tunnel station or bus zone in the CBD.
- Customers are responsible for loading and unloading bikes. If assistance is necessary, please offer verbal instructions on how to use the rack.
- The bike rack holds two bicycles. If a third cyclist wishes to board, ask him or her to wait for the next coach. Please do not call the coordinator for bike rack overloads. If passing up cyclists is a consistent problem, submit an Incident Report.

FIGURE 22: Instructional Booklet Prepared For Seattle Metro Bus Operators (cont'd.)

**Loading Bicycles on the Bike Rack**

Have the customer remove any loose items that could fall off the bike while the bus is in motion.

1. Instruct the customer to approach the rack from curbside, then squeeze the handle located in the center of the bike rack to release the latch. The bike rack folds down. (A)

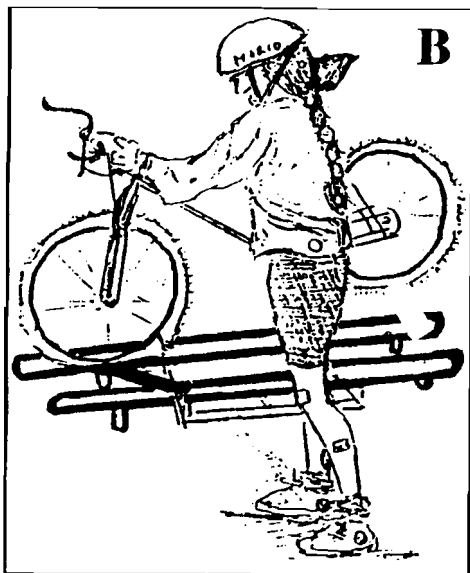
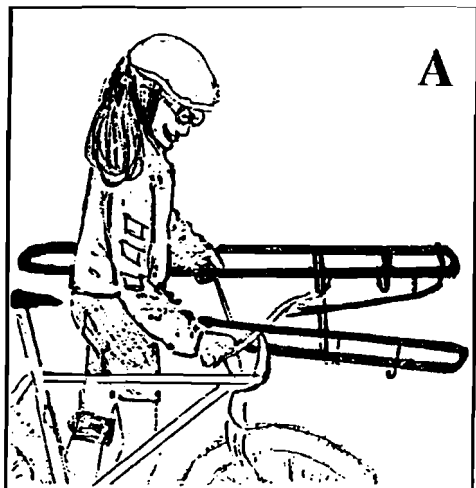

2. Have the customer lift the bicycle onto the rack, fitting the wheels in the proper wheel slots. (B) (NOTE: The rack operates properly even if a bicycle is loaded in the wrong direction.) The purpose of the directional placement is to make the bike nearest the bus easier to unload.

3. Instruct the customer to pull the spring-loaded support arm out and raise it up and over the front tire. (C, D) Make sure that each bike is secured with the support arm at the top of the front tire. (E)

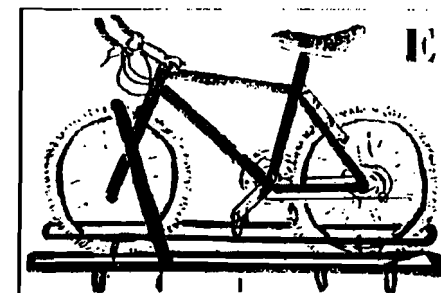
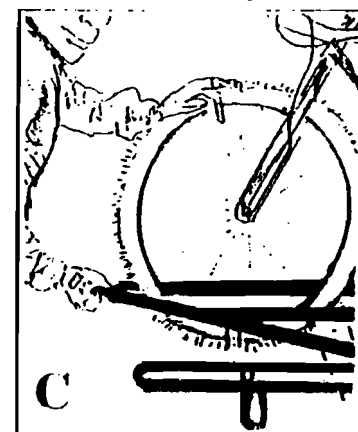
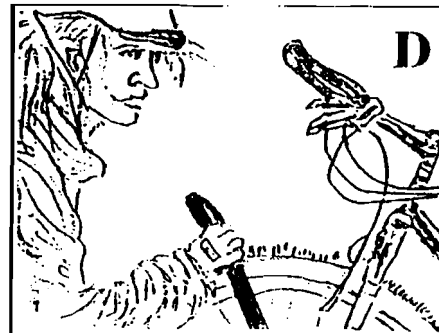

**Unloading a Bike**

To remove a bike, have the customer reverse the order of the steps listed above. Ask the customer to fold up the bike rack if there are no bikes on the rack and no one else is waiting to load their bike.

*Caution: Do not move the coach before ensuring that the empty bike rack is closed. If you cannot see the position of the rack from your seat, look through the special mirror installed specifically for that purpose.*

**FIGURE 22: Instructional Booklet Prepared For Seattle Metro Bus Operators (cont'd.)**

**Special Tips and Precautions**

The following information should help you provide safe and efficient service for your bike and ride customers.

**Loading and unloading**

- During the loading procedure, ensure that the bicycle is properly secured with the support arm at the top of the front tire. If the support arm has not been extended or is resting lower than the hub of the tire, ask the customer to reposition it before you proceed.
- If only one bike is being loaded on the rack, ask the customer to use the outside slot. This will give you a point of reference to gauge your clearances. (A loaded bike rack adds three feet to the front of the coach.)
- Be sure to leave some room in front of the coach for customers to maneuver when loading and unloading bikes. Allow six feet between coaches (three feet for the bike rack and three feet for the cyclist) when you know customers will be using the rack.
- Make a habit of asking your biking customers their destination in advance so you can plan your stop. Also be alert for the intending cyclist in the zone.
- After bicycles have been unloaded, do not move the coach before ensuring that the bike rack is closed.
- Make sure that cyclists have cleared the area in front of the coach before you proceed.
- Be alert to departing cyclists who may ride off to the left of the coach. Also double-check your right side, as cyclists may ride into your pocket area.

**On the Road**

- Remember to allow for the open bike rack when making turns. On right turns, make sure the left front of the rack clears oncoming vehicles stopped in traffic. On left turns, avoid turning too late or the rack may not clear fixed objects on the right.
- Always stop in such a manner that the bike rack does not extend into the crosswalk or beyond the stop bar.
- Before proceeding on a green light, make sure you have enough room to completely clear the intersection.
- Remember to allow for the bike rack when stopping in traffic behind other vehicles. You should always leave ten feet between your coach and the vehicle in front.
- Use extra caution when pulling into bus zones occupied by other coaches. When pulling out around parked vehicles, be sure to check your clearances both in front and on the right.
- In the closed position the bike rack extends eight inches from the front bumper of the coach. Allow for this when pulling into zones occupied by other coaches and when parking in the base.

**Conclusion**

While Metro has operated the bike and ride program on the Eastside for several years, most of our customers are not familiar with this unique service. Keep in mind that people need time to become comfortable with new technology and procedures. So be patient both with the first-time bike rack user and with yourself!

If you have suggestions for improving bike and ride service, please complete an Operator Service Report. And for questions about bike racks, please see your instructors in the Training office.



The following is a recommended procedure for bus operators when they interact with bicyclists desiring to use the bike-on-bus service. At such time as the *Bus Operators Manual* is updated, bike-on-bus procedures should be incorporated into the manual.

**Recommended Bike-on-Bus Boarding Procedure  
Bus Operator's Perspective:**

*Bicycle Loading and Passenger Boarding*

1. Pulling up to a bus stop where there is a customer holding a bicycle is the first indicator that a bicyclist wants to use the bike-on-bus service. The bicyclist should be waiting on the sidewalk and completely out of the road.
2. Make eye contact with the bicyclist. Motion the bicyclist to proceed into the road only after you have opened the doors of the bus to activate the brake interlock system. For example, you can communicate to the bicyclist by waving your hand, nodding your head or saying "O.K."
3. If the rack is already full, tell the bicyclist that he can wait either for next bus or park the bicycle at the bus stop and board without it. Tell the bicyclist when the next bus is scheduled to arrive.
4. If the rack is not full, require the bicyclist to present his permit before beginning to load the bicycle. If the bicyclist has a youth permit, permit him to board only if accompanied by an adult (over age 18) with a regular permit.
5. Allow the bicyclist to proceed with loading his bicycle while other passengers are boarding.
6. Monitor the activity of the bicyclist to ensure that he is loading the bicycle securely and properly.
7. If he is having difficulty, provide him with verbal instructions. Do not load the bicycle for him.
8. Register the bike-on-bus passenger on your route tally of bike-on-bus ridership.
9. When the bicyclist boards and pays his fare, find out which bus stop he intends to get off the bus. Make a mental note of it.

### *Bicycle Unloading and Passenger Deboarding*

1. When the bicyclist indicates his intention to deboard and you reach his bus stop, the bicyclist should remind you that he intends to unload his bicycle from the rack. Remember that he may forget to communicate his intention to you.
2. The bicyclist will exit the bus through the front door, then walk to the front of the bus to unload his bicycle. Make sure the bus doors remain open until the bicyclist and his bicycle are safely out of the road.
3. Monitor the activity of the bicyclist to ensure that he is unloading the bicycle properly from the rack.
4. Make sure that the bicyclist folds the rack up if there are no other bicycles on the rack.
5. Do not close the doors or move the bus until the bicyclist and his bicycle are safely out of the road and onto the sidewalk.

### **BUS MAINTENANCE PERSONNEL**

Newly hired maintenance personnel participate in an initial training program of MDTA. Refresher training is conducted yearly. Other training occurs as needed, such as manufacturer's training upon receipt of new equipment. Tool Box Safety Meetings also occur weekly.<sup>74</sup> The information and hands-on experience required by bus maintenance personnel for installing and maintaining bicycle racks can be presented within this existing framework of training.

The MetroBus Maintenance Division should initially be actively involved in devising the performance specifications for the bicycle racks, such that maintenance concerns are addressed and incorporated into the rack design. It is recommended that as part of the work order for the manufacture and delivery of bicycle racks, the vendor should supply detailed written instructions for rack maintenance and repair, complete with illustrations and/or photographs.

As specifications for a satisfactory rack design are finalized, maintenance procedures can be codified. Computerized files can be established for recording rack performance data and the completion of maintenance activity. The establishment of the recordkeeping system would provide the framework for the maintenance routine for which maintenance personnel must be trained.

---

<sup>74</sup> MDTA Transit Safety and Assurance, System Safety Program Plan, July, 1992, Appendix C.



Bus maintenance personnel could begin their involvement by assisting in the testing of the bicycle racks during the demonstration program. As directed by the MDTA System Safety Program Plan, maintenance practices begin with directions of maintenance and repair manuals supplied by the vendor.

Maintenance practices for which personnel will require training include the secure installation and proper removal of the bicycle rack from the bus, using a sequence of steps devised to:

- maximize safety of personnel;
- minimize the time required to carry out the process; and
- prevent damage to the rack and the bus.

Such a sequence of steps for removing a bicycle rack may vary depending upon the purpose for removing it. For example, accessing a bus maintenance hatch may not require complete removal of the rack. Some racks are designed so that only the latch mechanism must be removed to access the maintenance hatch.

Bus maintenance personnel will need to be thoroughly familiar with the names of rack parts, their function, the way the parts are assembled and the durability of the parts. Personnel must learn to recognize normal and abnormal signs of wear and tear. Abnormal wear could indicate part defects. For example, the rack manufacturers surveyed for this report offer one-year warranties on material defects, which maintenance staff should report in order for MDTA to pursue immediate replacement at no cost.

Some rack designs presently on the market weigh under 30 lbs. Others weigh as much as 70 lbs. A very important element of maintenance staff training regarding safety is proper lifting techniques. Although a light weight rack is an important performance specification to consider, all rack designs are bulky, making them more difficult to lift and carry than would otherwise be expected. It is also recommended that training procedures be devised, where necessary, for team work. Heavy lifting may be an application requiring more than one person, for which properly coordinated technique would prevent injury.

## **SUMMARY**

Training customer service representatives is highly desirable for providing accurate and helpful information to the public that promotes safety, conveys a positive image and encourages customers to use the service. These staff can also provide good feedback in the development of informational and instructional materials for the public.

Training for bus operators and bus maintenance staff of public transit systems is required by law. In accordance with the law, it is recommended that the current program of bus operator training incorporate instruction in the safe and proper use of bicycle racks. A stand-alone instruction module should be developed as a training supplement and administered to experienced bus

operators who drive routes that are selected for the demonstration program. The bike-on-bus training should also be incorporated into the initial training of newly hired bus operators in addition to refresher training courses. This section includes a list of topics that bus operator training should include, in addition to a recommended bike-on-bus boarding procedure from the bus operator's perspective.

The MetroBus Maintenance Division should initially be actively involved in devising the performance specifications for the bicycle racks, such that maintenance concerns are addressed and incorporated into the rack design. Bus maintenance personnel could begin their involvement by assisting in the testing of the bicycle racks during the demonstration program. As specifications for a satisfactory rack design are finalized, maintenance procedures can be established as the foundation for training curricula for bus maintenance personnel. Such training should include proper lifting techniques to prevent injury.

A fundamental element of a training program is to develop interest and support for the bike-on-bus demonstration by MDTA staff. Experienced demonstration program planners have emphasized the importance of strong leadership from top management to generate acceptance, enthusiasm and the cooperation of operational staff that is so crucial for a successful program.

## **MONITORING THE MDTA BIKE-ON-BUS DEMONSTRATION PROGRAM**

Monitoring and collecting information about the performance of the MDTA bike-on-bus demonstration program helps to answer three questions. These are:

- Is the program useful? Does it provide benefits?
- Should the program be continued past the demonstration?
- How can program operations, equipment and procedures be improved?

Determining what kind of information to collect partly depends upon the objectives of the demonstration program, as specified by the bike-on-bus project team. In addition to specifying information types, a monitoring plan also should identify who will collect the data and specify the best method and times to collect the data. Especially for the measurement of program results and benefits, it is important to first establish baseline conditions from which to compare the impact of the program.

Prior to the creation of a monitoring program, the time length of the demonstration should be determined. While some demonstration programs have been conducted over the course of six months, it is recommended that a one-year time frame be considered. This gives the opportunity to see the program in action over the course of seasonal fluctuations, in addition to providing sufficient time to make and test alterations to the program.

### **CMAQ FUNDED PROJECTS**

Data requirements for evaluation needs imposed by certain funding programs are also important to consider in an information collection plan. For example, many transit systems have used CMAQ funds for the purchase of bicycle racks. The awarding of CMAQ funds is contingent upon demonstrating the likelihood of air quality emissions reduction. One way this can be achieved is if analysis indicates a shift in mode share from motor vehicle travel to increased use of bicycling and transit use as a result of the bike-on-bus demonstration program.

### **MEASURING BENEFITS**

Awareness and demonstrated interest in the bike-on-bus service can be measured by the number of bike-on-bus permits issued and the rate of increase in the number of permits issued over the course of the demonstration program. The residential locations of bike-on-bus permit holders may provide information concerning location of greater service demand.

Measures of service effectiveness and customer satisfaction can include the number of bike-on-bus riders by route, run direction, date and time of day. Such a tally of the number of bike-on-bus patrons can be collected by the bus operator. Changes in overall ridership since before the demonstration, could be measured by bus boarding counts.

Bus stop locations with a growing incidence of bike-on-bus boarding and exiting may provide information about the generators of service demand along the selected routes.

A telephone information line and comments cards could collect the number of complaints and positive comments received. More importantly, the specific nature of the concerns can be collected in order to be reviewed and addressed by the bike-on-bus project team. Positive comments are equally important in order to know what the program is doing right and what customers particularly need and appreciate.

With authors' permission, positive comments also can be used as quotations on informational brochures to better publicize the service. It is important to note that the measure of bike-on-bus patronage may be less an indication of demand for service, but more an indication of the degree of success of the publicity and promotion of the service.

Surveys should also be administered to the bus operators to collect their observations about the service. Open-ended questions can serve this purpose, such as: What do customers appear to like/dislike about the service? How can operational procedures be improved? Some transit agencies that publish internal staff newsletters, have enabled program staff to provide comments at any time, through the use of a detachable comment sheet on the back of the newsletter.

## **EQUIPMENT, OPERATIONS AND PROCEDURES FINE TUNING**

### **Rack Effectiveness**

The effectiveness of the rack can be characterized by how easy it is to operate the rack, how quickly a customer can load or unload a bicycle, how securely the rack holds the bicycles, and whether damage occurs to the bicycles, the rack or the bus during proper use. Rack effectiveness can be monitored by the use of comments cards collected from customers and bus operator comments from surveys and comments cards. Bicycle security can be monitored through the on-going record of pre-departure inspections of the bicycle racks and the number and nature of incident reports of bicycles coming loose or falling from the rack.

Cost effectiveness of the rack can be monitored by its durability relative to warranties. Pre-departure inspections and incident reports can provide a record of how well the racks are wearing. Such a record can distinguish isolated problems from patterns that may indicate weaknesses in the design that require modification.

## **Service Schedule Delay**

Saving the customer travel time would be a potent selling point. One of the most important measures of service effectiveness is consistent, on-time service. Reliability generates satisfied customers. One of the greatest issues of concern to transit agencies is whether a bike-on-bus service will cause schedule delay.

The Phoenix Transit System addressed this issue by surveying bus passengers and bus operators and found that passengers estimated bicycle loading and unloading times to be less than the estimates provided by the bus operators. This may indicate that the loading and unloading times were not actually recorded by stop watch. Instead, the surveys measured perceptions about loading times. For example, Phoenix rider surveys indicated the perception that bus schedules remained on time and no delays were caused by the demonstration service. The fact that bus operators perceived a longer bicycle loading time may be more of an indication of concern felt by bus operators to adhere to the schedule and the desire to minimize any circumstances that might cause delay.

A procedure for objectively timing bicycle rack loading and unloading would require the use of a stop watch and the identification of the moments in time at which to begin and end the timing. This would be conducted preferably by a monitor seated aboard the bus since the bus operator is already busy attending to the needs of other boarding passengers and the bike/bus passenger is occupied with the task of loading/unloading the bicycle. Any delay caused by loading a bicycle onto a rack is equal to the time it takes for the bike/bus passenger to complete the specified loading procedure and board the bus, less the time it would take for the same passenger to board if no bicycle were loaded. The same would be true for disembarking the bus and unloading a bicycle from the rack. This delay time may be extended if there is a disembarking bike/bus passenger who first must unload his bicycle from the rack before another bike/bus passenger can begin loading his bicycle onto the rack and board the bus. However, the policy of other established bike-on-bus programs has been to require the bike/bus passenger to allow all other passengers to board the bus first while he is loading his bicycle. When this is the case, depending upon the number of other passengers boarding simultaneously, there may be less or no added delay due to loading or unloading bicycles from the rack.

There are numerous unrelated circumstances that may arise during a scheduled bus route that could cause isolated instances of delay. Examples include congestion due to roadway construction or a collision, bus mechanical problems or a sudden large group of tourists boarding the bus for sightseeing. Delay caused by a bike-on-bus program more likely would occur when a bus passenger first tries the bike-on-bus service. Once the passenger has used the rack once or twice and has learned the routine, the length of time required to load/unload a bicycle would decrease, then become consistent. There will be a period of time during the demonstration program, when all initial bike/bus passengers will be learning to use the new service. It is expected that the greatest delay will be experienced during the time in the demonstration program, when there is a peak in first-time bike-on-bus ridership. However, it is more likely that first-time ridership will be spread across a period of several weeks or months as more people

discover the program. It should be expected that some amount of delay will occur, but as the number of potential bike/bus passengers discovering the new service reaches a peak and levels off, these individuals using the bike-on-bus service regularly will quickly become skilled users of the service.

Over the course of the bike-on-bus program, even if it were to go beyond a demonstration program and become a permanent service, there always will be some small number of new bike/bus passengers, trying the service for the first time and taking a greater than average time to load/unload a bicycle. However, in comparison to the general ridership, there always will be some small number of new passengers without bicycles, who are merely trying bus transit for the first time and who require additional time to ask for directions from the bus operator, to receive assistance paying fares, making transfers and knowing when and how to exit the bus. These may be tourists, new residents of the city or simply those exploring a new mode of travel. It would be inconceivable that a bus transit system would discourage these new users of the service because they require additional time to learn! Transit systems want to attract new ridership and strive to provide service to all potential riders inclusively.

The more popular the bike-on-bus service becomes to the public, the more regular bike/bus riders there may be and the more delay the service will cause. The worst delay scenario would be described by a high rate of loading/unloading if bike/bus passengers rode the bus for short distances only. This is not anticipated to occur, as in the case of the Phoenix Transit System, the more popular bus routes for bicyclists have been the longer routes, suggesting the desire of bike/bus passengers to cover longer travel distances. It would be less likely that a bicyclist would ride a bus for only one or two stops; it would be quicker and easier to bicycle the entire way, unless there were a "bottleneck" or some physical barrier impeding bicyclists that would suggest the need for spot improvements.<sup>75</sup> Additionally, the limited two-bicycle capacity of a front-mounted rack would place a cap on delay caused by bike/bus passenger loading/unloading. Increased loading/unloading activity would increase delay as future rack designs held more bicycles and as the service was fully used.

While acknowledging that some route delay may occur due to bike/bus ridership, in comparison with other passenger submarkets that constitute regular ridership, there is no reason to prioritize service to one submarket over another. For example, the elderly and persons with disabilities may routinely require additional time boarding, safely seating themselves and exiting a bus, yet patronage from these persons is rightly encouraged as transit accessibility continues to improve for them. For all transit customers, as bus service patronage increases, the dwell time at a bus stop will increase due to larger numbers of boarding and exiting passengers. Route scheduling must be periodically adjusted to accommodate these positive changes. Likewise, if bus patrons find a bike-on-bus service to be a needed and favorable addition to transit service, as have bus patrons of other urban areas, then the average additional time routinely required by bike/bus passengers should be accounted for in a modified schedule.

---

<sup>75</sup> Bruce Epperson, Senior Planner, Metro-Dade Planning Department. February, 1995.

To determine the presence of systematic schedule delay due to the bike-on-bus service, average schedule adherence by route, day of week and time of day would need to be ascertained prior to the beginning of the bike-on-bus demonstration program in order to compare with schedule adherence during the demonstration program. Overall schedule adherence, as affected by the bike-on-bus demonstration program, can be monitored by the dispatcher. Chronic schedule delay may already exist for a route prior to the implementation of bike-on-bus service if, for example, the bus operators encounter consistent difficulty finding a safe gap in the traffic stream to make a turn at a busy intersection.

The more established bike-on-bus programs represented as case studies in this report have not cited the need to appreciably alter route schedules due to bike-on-bus service. For example, the bus operators of the Bikes on Tri-Met program of Portland had also expressed concern about the possibility of schedule delay due to loading and unloading of bicycles onto racks. Aside from a few isolated events, program staff found no systematic schedule delay due to Bikes on Tri-Met.

The observations of bus operators can be valuable in improving bicycle loading and unloading procedures to reduce delay.

## **MONITORING SAFETY**

While improved transit service may be a primary objective selected by MDTA for a bike-on-bus program, it goes hand in hand with minimizing the potential for injury to MDTA staff and program participants. Actions undertaken to achieve safe conditions include the procedures devised for loading and unloading the bicycle rack by passengers, and maintenance procedures followed by MDTA personnel. Safety can be monitored by noting the number and severity of incidents that have occurred within a given period of time, compared to a bike-on-bus service usage rate.

Those transit agencies contacted who have bike-on-bus programs have experienced no serious incidents. Clues for identifying hazardous conditions can be obtained from incident reports filed by bus operators and maintenance personnel. Other information should include comments filed by customers. These comments can be obtained through survey instruments and suggestion cards continually available for customers' use. Concerns and complaints communicated through a customer service telephone line can contain important information, especially if patterns can be found.

Surveys of bus operators should also be conducted, containing questions that include:

- problems with passenger compliance with program rules. Are customers defiant or simply unknowledgeable?
- incidence of bicyclists stepping into a lane of moving traffic while loading/unloading a bicycle from a rack.

- incidence of bicycles coming loose or falling from the rack.

This information should be referenced by bus route, date and time of day. Bus operators should also be asked open-ended questions: Are there any safety problems? What can be done to improve the loading/unloading procedure?

Seattle Metro involved both the bus operators and the customers by setting up displays with two racks prototypes, in which customers could test the racks themselves and provide comments and suggestions. This is an important opportunity for safety managers to observe behavior and note any potential problems. Phoenix used a combination of written surveys with follow-up phone calls to those who provided phone numbers.

In addition to the information specified above, records should be kept documenting staff training and program participant permitting. Records should also be kept of the number and dollar amount of claims filed relating to the program.

## BEYOND THE DEMONSTRATION

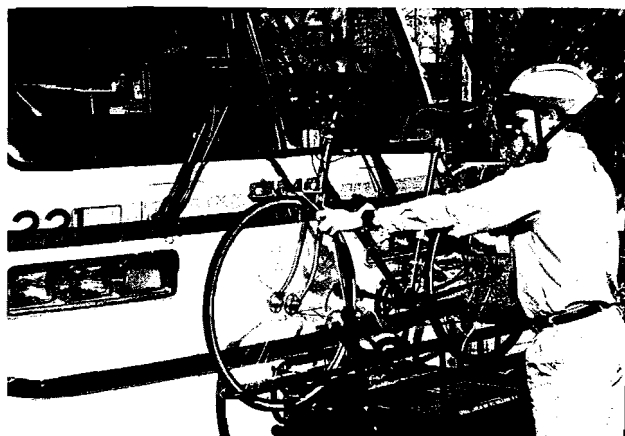

*A student from the University of South Florida loads a bicycle onto a HARTline bicycle rack.*

Whether to continue a bike-on-bus program beyond the demonstration may involve several considerations, such as whether program costs outweigh benefits and whether any unacceptable difficulties or risks can be reduced or eliminated by a change in procedure or equipment. A permanent program may mean a continuation of service on the original three selected routes or some combination of other routes. It may also mean systemwide implementation. The results of a monitoring and information collection program should help to guide future decisionmaking. liability for any property damage or injury. Although some planners are concerned that requiring permitting may discourage individuals from using the service, a permitting process provides a chance to communicate procedures, reinforce safety principles, promote public confidence and enforce an age restriction if there is one.



An important principle when developing a performance monitoring program for the bike-on-bus demonstration is to give the opportunity for all program participants to provide comments and ideas. Participants include planning staff, bus operators, maintenance and training personnel, customer service representatives, passengers using the bike-on-bus service as the general ridership, and the public. Such feedback from multiple perspectives can ultimately provide the information to guide decisions regarding program continuation beyond the demonstration, in addition to indicators pointing to service improvement opportunities.



## BIBLIOGRAPHY

American Association of State Highway and Transportation Officials. *A Policy on Geometric Design of Highways and Streets*. Washington, D.C., Editions 1984 and 1990.

Bicycle Federation of America & Pedestrian Federation of America. *Pro Bike/Pro Walk 94: Resource Book*. Portland: September 6-9, 1994.

Center for Urban Transportation Research. *Performance Evaluation Of Florida Transit Systems: Part II Peer Review Analysis*. Prepared for the Florida Department of Transportation, October 1990.

\_\_\_\_\_. "Performance Evaluation of Florida's Transit Systems: Part II, Peer Review Analysis 1992, Final Report." Tallahassee: Office of Public Transportation Operations, Florida Department of Transportation, March 1994.

\_\_\_\_\_. Dade County Five-Year Transportation Disadvantaged Plan 1992-1996, Final Report. Prepared for Metro-Dade Metropolitan Planning Organization. Miami. August 1992.

Center for Urban Transportation Research and Behavioral Science Research Corporation. "MDTA On-Board Survey Analysis Final Report." Prepared for Metro-Dade Transit Agency. Miami: May 1994.

\_\_\_\_\_. "MDTA On-Board Survey Analysis Appendix B: Metrobus Demographic and Travel Characteristics By Route." Prepared for Metro-Dade Transit Agency. Miami: May 1994.

Florida Department of Transportation, Division of Planning. *Bicycle Facilities Planning & Design Manual, Official Standards Revised*, 1992.

Florida Department of Transportation and Florida Institute For Marketing Alternative Transportation. *On The Road Again*. Video.

Florida Institute For Marketing Alternative Transportation. *Development and Pretests of A Promotional Video For The Florida Department of Transportation "On the Road Again."* Prepared for The Florida Department of Transportation, December 1993.

Forester, J. *Effective Cycling*. The MIT Press, Cambridge: 1994.

Giannopoulos, G.A. *Bus Planning and Operation in Urban Areas: A Practical Guide*. Brookfield: Gower Publishing Company, 1993.

Metropolitan Dade County and Transport Workers Union. *Collective Bargaining Agreement Local 291*. October 1, 1990 - September 30, 1993.

Metropolitan Dade County. *Adopted Components Comprehensive Development Master Plan for Metropolitan Dade County, Florida*. Miami: Amended April, 1993..

Metro-Dade Transit Agency. "Metro-Dade Transit Agency Transit Development Program, 1993." June (revised July 15) 1993.

\_\_\_\_\_. *Metrobus Bus Operators' Manual*, 1994.

\_\_\_\_\_. *Transit Safety & Assurance System Safety Program Plan*. Revision -3. Miami: July 1992.

National Transit Institute. "A New Technology Seminar: Implementing Total Quality Principles in Transit." Orlando: February 5, 1994.

Phoenix Transit System. "Bike-on-Bus Demonstration Program." September 1991.

Portland Tri-Met. *Bikes On Transit*. Video. 1993.

Replogle, Michael. *Bicycles & Public Transportation: New Links To Suburban Transit Markets*. Published by The Bicycle Federation, 1988.

Sportworks, N.W., Inc. *Bus Rack*. Video.

Transportation Research Board National Research Council. *Integration of Bicycles and Transit*. TCRP Synthesis 4 (1994).

\_\_\_\_\_. *Low-Floor Transit Buses: A Synthesis of Transit Practice*. TCRP Synthesis 2 (1994).

\_\_\_\_\_. *Incentive Programs to Improve Transit Employee Performance*. TCRP Synthesis 3 (1994).

Universal Technical Institute - Industrial Training Division. *Coach Maintenance Training: Instructors' Lesson Plan for Preventive Maintenance - Coach*. Phoenix: 1991.

U.S. Department of Transportation. *Linking Bicycle/Pedestrian Facilities with Transit*. National Bicycle and Walking Study FHWA Case Study No. 9. Submitted to Federal Highway Administration, Washington, DC: October 1992.

\_\_\_\_\_. *1990 Census Transportation Planning Package Application*. NHI Course No. 15131 (FHWA-HI-92-049) May 1992.

\_\_\_\_\_. *The National Bicycling and Walking Study: Transportation Choices for a Changing America, Final Report.* (FHWA-PD-94-023). Prepared for the Federal Highway Administration, Washington, DC: 1994.

\_\_\_\_\_. *Data Tables: For the 1992 Section 15 Report Year.* Audit Review and Analysis Division Office of Capital and Formula Assistance. Prepared for Federal Transit Administration, Washington,DC: December 1993.

\_\_\_\_\_. *Transit Profiles the Thirty Largest Agencies: For the 1992 Section 15 Report Year.* Audit Review and Analysis Division Office of Capital and Formula Assistance. Prepared for Federal Transit Administration, Washington, DC: December 1993.



**APPENDICES**





## APPENDIX A: GOVERNMENT POLICY OVERVIEW

### FEDERAL DIRECTIVES AND STATE PROGRAMMATIC SUPPORT

Since the federal government passed the Clean Air Act Amendments in 1990 and the Intermodal Surface Transportation Efficiency Act (ISTEA) in 1991, new direction and funding sources have been provided to local governments. The new direction includes strengthening intermodal linkages, finding a better balance among multiple transportation modes, managing traffic congestion and recognizing the relationship between transportation and air quality. The bike-on-bus concept addresses all of these. The new ISTEA funding sources include transportation enhancement funds as part of the Surface Transportation Program (STP). These funds can be used for eligible projects, including the development of bicycle facilities. Another source of ISTEA funding is the Congestion Mitigation and Air Quality (CMAQ) funds to be used for transit capital and transit-related projects, bicycle facilities and transportation demand management programs, among many other eligible projects. Several urban areas have used these funds to help establish bike-on-bus programs.

Under the sponsorship of FHWA of the U.S. Department of Transportation, the *National Bicycling and Walking Study* was conducted between 1991 and 1994, in which travel data was presented and case studies were prepared, addressing particular aspects of bicycling and walking issues. The Final Report of the study established goals for doubling the amount of bicycling and walking activity, in addition to identifying action plans and programs at all government levels for promoting such a travel mode shift.

Because the bike-on-bus service makes possible a multimodal journey, its success depends upon the success of each bus and bicycle trip link. The long-term effectiveness and mainstream appeal of a bike-on-bus service is therefore partly dependent upon the availability of bicycle lanes, paths and other facilities that make the bicycling portion of the journey safe and convenient.

The potential success of a bike-on-bus service in Metro-Dade County is strengthened by the work of the state bicycle program, recognized as one of the best in the nation, which provides programmatic support to local bicycle coordinators. State growth management laws require bicycle planning as part of the local government comprehensive planning process.<sup>76</sup> For state transportation facilities, any construction, reconstruction or other change must also be accompanied by the establishment of bicycle facilities.<sup>77</sup> The Florida Department of

---

<sup>76</sup> see 163.3177(6)(b) F.S. and 163.3177(j)1-2 F.S.

<sup>77</sup> 335.065(1)(a). Bicycle and pedestrian ways shall be given full consideration in the planning and development of transportation facilities, including the incorporation of such ways into state, regional, and local transportation plans and programs. Bicycle and pedestrian ways shall be established in conjunction with the construction, reconstruction, or other change of any state transportation facility, and special emphasis shall be given to projects in or within one mile of an urban area.

Transportation is presently revising the 1982 Florida standards for bicycle facilities to reflect the latest in safety and operations research and experience.<sup>78</sup>

Regarding bicycle operations, Florida is ahead of many other states in that the Uniform Traffic Control Law recognizes bicycles as *vehicles* that are permitted full use of the roadway and applies the same rights and responsibilities to bicyclists as to the operators of motor vehicles.<sup>79</sup> To fully realize the potential of the law, greater levels of traffic safety education and law enforcement must be put in place to assert these rights and responsibilities.

This state framework provides a solid foundation for the development of the bicycle as effective transportation in Metro-Dade County.

### **Bike-on-Bus Consistency With Local Transportation Policy**

A review of the planning policy framework at the local level indicates that a bike-on-bus service would support several transportation goals and objectives of Metro-Dade County. The review also indicates that Metro-Dade County has a history of commitment to bicycle planning and programs that begin to provide other aspects of a complete system necessary for making bicycling for transportation effective. Here is a summary of such supporting policies and programs:

### **Comprehensive Development Master Plan**

The Comprehensive Development Master Plan for Metro-Dade County contains goals and objectives for traffic circulation and mass transit that emphasize:

- ease of mobility and intermodal transfer;
- energy conservation;
- promotion of a more balanced transportation system;
- more efficient use of transportation investments;
- improvement in air quality; and
- convenient, accessible, affordable and equitable service.

These goals and objectives have been cited by other urban areas as those supported by a bike-on-bus service.

---

<sup>78</sup> These revisions will be available from FDOT in March, 1995, and they will serve as an update to the "Bicycle Facilities Planning & Design Manual, Official Standards," Division of Planning, Florida Department of Transportation, Revised 1982.

<sup>79</sup> 316.2065 F.S.

The accommodation of non-motorized vehicular traffic was explicitly adopted as an objective in the CDMP, with supporting policies to implement a county comprehensive bicycle plan, to encourage bicycle facilities in development plans and to require the County to consider incorporating bicycle facilities in new road construction and within utility easements. Mass transit facilities are to incorporate provisions, such as bicycle lockers and racks, to enhance ease of transfer with other modes.<sup>80</sup> Facilities and programs for a bike-on-bus service would be a natural extension of these objectives and policies supporting non-motorized travel.

### **Dade County Comprehensive Bicycle Planning**

Bicycle planning as a means of transportation and recreation dates back to 1972, when the Dade County Bikeways Plan was published. In 1986, the staff of the metropolitan planning organization prepared the Metropolitan Dade County Comprehensive Bicycle Plan, which used the "4 E" programmatic approach (engineering, education, enforcement, encouragement) to bicycle planning. The 1986 Plan discusses integration of transit and bicycling, including the Bike-N-Ride Program, which has provided for bicycle parking at Metrorail stations, and the Bike on Train Program, which has allowed bicycles aboard Metrorail since 1983. Plan recommendations included adjusting user hours for permitting bicycles on trains and the installation of bicycle racks and lockers not only at Metrorail stations but also at Metrobus terminals. The Plan also suggested installing bicycle racks on buses, as a means to increase bicycle/transit integration.<sup>81</sup>

In 1994, the MPO Governing Board adopted the Bicycle Facilities Development Guide, which contains a policy requiring the incorporation of bicycle facilities into County plans for new road construction, widening or reconstruction. The preparation of the Dade County Bicycle Facilities Plan was also authorized in the 1993 Unified Planning Work Program. Almost completed, the new Facilities Plan will provide guidance for establishing a county-wide system of bicycle facilities in order to provide for safe and efficient travel while "...enhancing a balanced intermodal transportation system."<sup>82</sup>

---

<sup>80</sup> Metropolitan Dade County. Comprehensive Development Master Plan. Miami, Florida, amended April, 1993.

<sup>81</sup> Metropolitan Planning Organization for the Miami Urbanized Area. Metropolitan Dade County Comprehensive Bicycle Plan. Miami, Florida, October, 1986: 9.

<sup>82</sup> Metropolitan Planning Organization for the Miami Urbanized Area. "Transportation Improvement Program, Fiscal Year 1995, Non-Motorized Component." Miami, Florida, 1993: 177.

## **Transportation Systems Management**

The "Transportation Demand Management & Congestion Mitigation Study" prepared for the MPO in 1993 recommends the requirement that non-residential development orders provide for secure bicycle parking and that county zoning ordinances include bicycle parking and clothes lockers and shower facilities as part of the site plan approval process.<sup>83</sup>

### **Metro-Dade County and City of Miami Concurrency Management Systems**

Adequate public facilities ordinances, known as concurrency by local governments in Florida, ensure that facilities will be provided concurrent with the impacts from new development. Transportation facilities fall under concurrency requirements. Among the most progressive concurrency management systems in the state of Florida for incorporating transit considerations are those used by the City of Miami and Metro-Dade County. Resulting in a strengthened emphasis upon transit, this may shape conditions for which a bike-on-bus service would benefit the travelling public.

The City of Miami evaluates the adequacy of its transportation facilities by aggregating the service capacities of parallel highway and transit facilities in designated corridors. Instead of measuring service capacity by how many vehicles can be accommodated by the system, service capacity is measured by how many person-trips can be made within the designated peak period. No other local government in Florida evaluates their transportation system in this way.<sup>84</sup> This method shifts some of the emphasis away from building new highway capacity and may build automobile congestion levels to a degree that transit travel, including bus travel, become more desirable. The use of the measure of person-trips rather than vehicle trips might provide room in the developing concurrency evaluation methodology to consider a measure for bicycle level of service, which might include lanes for bicycle traffic only.

The concurrency management system of Metro-Dade County will also incorporate transit consideration into their assessment of adequate transportation facilities. However, instead of achieving this by the method of *measuring* level of service, Metro-Dade County will incorporate transit consideration through their application of level of service *standards* based upon proximity to existing urban development and proximity to public transit service. Generally, the level of service standards become less auto-oriented as one travels toward the urban core.

Beginning January 1, 1995, proximity to transit service will determine the level of service standard. For example, within the urban development boundary where no transit service exists,

---

<sup>83</sup> Barton-Aschman Associates, Inc., "Transportation Demand Management & Congestion Mitigation Study," prepared for the Miami Urbanized Area MPO, (April, 1993): 13, 68.

<sup>84</sup> City of Miami Planning Department, "Transportation Corridors; Meeting the Challenge of Growth Management in Miami," (September, 1990).

state urban minor arterials must operate at LOS E or higher. All other roads must operate at LOS D or higher.

If transit service operates at 20-minute headways within 1/2 mile of a proposed development, then road facilities must operate at LOS E or higher. If "extraordinary" transit service such as passenger rail or express bus service exists within 1/2 mile of the proposed development, then roadways may operate at 120 percent of capacity. Within the urban infill area where no transit service exists, roadways must operate at LOS E or higher. However, if transit service does exist and operates at 20-minute headways within 1/2 mile of the proposed development, then road facilities may operate at 120 percent of capacity. If passenger rail or express bus service exists within 1/2 mile of the proposed development, then roadways may operate at 150 percent of capacity.<sup>85</sup>

This increase in allowable auto traffic congestion may tip the scale toward greater transit ridership. A bicycle ride along less congested residential and collector streets to the nearest bus stop may enable customers to avoid the drive along heavily congested arterials.

### **Roadway Condition Index**

The development of the Roadway Condition Index (RCI) is a means to measure a roadway segment's suitability for bicycle travel and to incorporate this measure into the overall transportation facility capacity determination, similar to that for transit service. For example, a roadway segment with good transit service and high suitability for bicycle travel may not necessarily meet the standard for motor vehicle level of service.<sup>86</sup>

---

<sup>85</sup> Metropolitan Dade County, Administrative Order 4-85, "Service Concurrency Fee Schedule, Standards, Evaluation Methods, Criteria, and Policies and Procedures," effective June 1992.

<sup>86</sup> Bruce Epperson, *Evaluating Suitability of Roadways for Bicycle Use: Towards a Cycling Level of Service Standard*. Transportation Research Board 1438. pp. 9-16.



**APPENDIX B:  
NUMBER OF WORKERS BICYCLING  
TO WORK IN DADE COUNTY  
1990 CENSUS**

Area	Number of workers using a bicycle as a means of transportation to work
Dade County	4,263
Andover CDP	0
Aventura	0
Bal Harbour Village	0
Bay Harbor Islands town	14
Biscayne Park Village	0
Brownsville CDP	0
Bunche Park CDP	13
Carol City CDP	65
Coral Gables city	173
Coral Terrace CDP	38
Country Club CDP	0
Cutler CDP	40
Cutler Ridge CDP	79
Doral CDP	7
El Portal Village	2
Florida City city	16
Gladeview CDP	14
Glenvar Heights CDP	35
Golden Beach town	0
Golden Glades CDP	39
Goulds CDP	0
Hammocks CDP	0
Hialeah city	276
Hialeah Gardens city	5
Homestead city	102
Homestead AFB city	161
Indian Creek Village	0
Islandia city	0

Ives Estates CDP	8
Kendale Lakes CDP	34
Kendall CDP	167
Kendall Lakes West CDP	14
Key Biscayne CDP	34
Lake Lucerne CDP	37
Lakes by the Bay CDP	10
Leisure City CDP	34
Lindgren Acres CDP	25
Medley town	5
Miami city	895
Miami Beach city	491
Miami Lakes CDP	0
Miami Shores Village	34
Miami Springs city	22
Naranja CDP	0
Norland CDP	6
North Bay Village city	23
North Miami city	132
North Miami Beach city	107
Ojus CDP	6
Olympia Heights CDP	76
Opa-locka city	100
Opa-locka North CDP	10
Palmetto Estates CDP	37
Palm Springs North CDP	10
Perrine CDP	0
Pinewood CDP	17
Princeton CDP	0
Richmond Heights CDP	8
Scott Lake CDP	9
South Miami city	60



South Miami Heights CDP	75
Sunny Isles CDP	23
Sunset CDP	33
Surfside town	13
Sweetwater city	20
Tamiami CDP	45
Virginia Gardens Village	10
Westchester CDP	61
West Little River CDP	35
West Miami city	0
Westview CDP	5
Westwood Lakes CDP	0
Tract 1.03	26
Tract 1.04	0
Tract 1.05	0
Tract 1.06	20
Tract 1.07	23
Tract 1.08	0
Tract 2.01	37
Tract 2.02	17
Tract 2.03	14
Tract 2.04	5
Tract 2.05	6
Tract 2.06	13
Tract 2.07	39
Tract 2.08	56
Tract 3.01	11
Tract 3.02	0
Tract 3.03	18
Tract 3.04	15
Tract 4.01	0
Tract 4.02	13

Tract 4.03	75
Tract 4.04	5
Tract 4.05	5
Tract 4.06	0
Tract 4.07	0
Tract 4.08	17
Tract 5.01	10
Tract 5.02	34
Tract 5.03	8
Tract 6.01	6
Tract 6.02	23
Tract 6.03	5
Tract 6.04	15
Tract 6.05	15
Tract 6.06	25
Tract 7.01	19
Tract 7.03	0
Tract 7.04	13
Tract 8.01	0
Tract 8.02	35
Tract 9.01	0
Tract 9.02	26
Tract 9.03	0
Tract 10.01	11
Tract 10.02	9
Tract 10.03	0
Tract 10.04	14
Tract 11.01	0
Tract 11.02	16
Tract 11.03	0
Tract 11.04	13
Tract 12.02	17

Tract 12.03	0
Tract 12.04	8
Tract 13.01	0
Tract 13.02	11
Tract 14.01	0
Tract 14.02	0
Tract 15.01	0
Tract 15.02	0
Tract 16.01	7
Tract 16.02	0
Tract 17.01	0
Tract 17.02	4
Tract 17.03	0
Tract 18.01	0
Tract 18.02	0
Tract 18.03	0
Tract 19.01	37
Tract 19.03	0
Tract 19.04	0
Tract 20.01	0
Tract 20.03	0
Tract 20.04	6
Tract 21	0
Tract 22.01	0
Tract 22.02	8
Tract 23	25
Tract 24.01	22
Tract 24.02	3
Tract 25	43
Tract 26	12
Tract 27.01	38
Tract 27.02	0

Tract 28	21
Tract 29	6
Tract 30.01	0
Tract 30.02	44
Tract 31	0
Tract 34	18
Tract 36.01	0
Tract 36.02	39
Tract 37.01	8
Tract 37.02	0
Tract 37.99	0
Tract 38	27
Tract 39.01	25
Tract 39.02	18
Tract 39.04	23
Tract 39.05	48
Tract 39.06	0
Tract 40	21
Tract 41.01	47
Tract 41.02	0
Tract 42	78
Tract 43	109
Tract 44	123
Tract 45	22
Tract 45.99	0
Tract 46.01	0
Tract 46.02	34
Tract 47.01	15
Tract 47.02	10
Tract 47.03	7
Tract 48	0
Tract 49.01	22

Tract 49.02	0
Tract 50.01	10
Tract 50.02	0
Tract 51	43
Tract 52.01	15
Tract 52.02	0
Tract 53.01	35
Tract 53.02	29
Tract 54.01	0
Tract 54.02	11
Tract 55.01	10
Tract 55.02	0
Tract 56	0
Tract 57.01	0
Tract 57.03	0
Tract 57.04	0
Tract 58.01	0
Tract 58.02	25
Tract 59.01	0
Tract 59.02	0
Tract 59.03	13
Tract 59.04	16
Tract 60.01	0
Tract 60.02	9
Tract 61.01	8
Tract 61.02	0
Tract 62	23
Tract 63.01	20
Tract 63.02	39
Tract 64.01	12
Tract 64.02	0
Tract 64.03	9

Tract 65	17
Tract 66.01	15
Tract 66.02	3
Tract 67.01	0
Tract 67.02	21
Tract 68	24
Tract 69	58
Tract 70.01	7
Tract 70.02	47
Tract 71	57
Tract 72	39
Tract 73	0
Tract 74	37
Tract 75.01	0
Tract 75.02	62
Tract 75.03	0
Tract 76.01	0
Tract 76.02	31
Tract 76.03	20
Tract 76.04	28
Tract 77.01	31
Tract 77.02	0
Tract 77.03	35
Tract 78.01	0
Tract 78.02	9
Tract 78.03	20
Tract 79.01	25
Tract 79.02	22
Tract 80	0
Tract 81	27
Tract 82.01	12
Tract 82.03	28

Tract 82.04	0
Tract 83.01	8
Tract 83.02	37
Tract 83.03	0
Tract 84.04	25
Tract 84.05	28
Tract 84.06	37
Tract 84.07	18
Tract 84.08	21
Tract 84.09	0
Tract 85.01	11
Tract 85.02	15
Tract 86	16
Tract 87	0
Tract 88.01	30
Tract 88.02	32
Tract 89.01	0
Tract 89.02	0
Tract 89.04	0
Tract 89.05	17
Tract 90.03	19
Tract 90.04	65
Tract 90.05	20
Tract 90.06	29
Tract 91	5
Tract 92	10
Tract 93.02	62
Tract 93.03	34
Tract 93.04	0
Tract 93.05	0
Tract 94	6
Tract 95.01	6

Tract 95.02	9
Tract 96	0
Tract 97.01	6
Tract 97.02	0
Tract 98	8
Tract 99.01	0
Tract 99.02	0
Tract 99.03	0
Tract 99.04	28
Tract 100.01	9
Tract 100.02	0
Tract 100.05	22
Tract 100.06	0
Tract 100.07	9
Tract 100.08	28
Tract 101.03	0
Tract 101.06	10
Tract 101.11	0
Tract 101.14	7
Tract 101.15	5
Tract 101.16	0
Tract 101.17	0
Tract 101.18	29
Tract 101.19	45
Tract 101.20	11
Tract 101.21	31
Tract 101.22	24
Tract 101.23	10
Tract 101.24	0
Tract 101.25	40
Tract 101.26	6
Tract 101.27	15



Tract 101.28	10
Tract 102.01	10
Tract 102.02	38
Tract 102.03	30
Tract 103	0
Tract 104	0
Tract 105	0
Tract 106.01	44
Tract 106.02	0
Tract 106.03	45
Tract 107.01	68
Tract 107.02	161
Tract 108	25
Tract 109	0
Tract 110.01	0
Tract 110.02	9
Tract 111	77
Tract 112.01	0
Tract 112.02	23
Tract 113	62
Tract 114.98	17
Tract 115	21
Tract 116.98	0



## APPENDIX C

### Bicycle Trip Generation Dade County Census Tracts Ordered by Magnitude of Trip Generation

Census tract	Annual Bike Trips	Avg. Weekly Bike Trips	Avg. Daily Bike Trips
101.19	179,469	3,451	493
90.04	176,989	3,404	486
101.23	176,560	3,395	485
101.25	170,199	3,273	468
7.01	149,866	2,882	412
101.16	144,862	2,786	398
90.05	144,173	2,773	396
93.03	136,042	2,616	374
93.02	130,996	2,519	360
101.21	129,051	2,482	355
101.22	113,379	2,180	311
102.02	99,011	1,904	272
84.04	87,811	1,689	241
88.02	85,511	1,644	235
98.00	83,065	1,597	228
106.03	78,085	1,502	215
107.01	77,259	1,486	212
84.08	73,817	1,420	203
101.27	72,575	1,396	199
87.00	71,836	1,381	197
30.02	71,406	1,373	196
101.28	71,318	1,372	196
101.18	71,114	1,368	195
86.00	71,049	1,366	195
2.07	70,385	1,354	193
106.01	69,556	1,338	191

<b>Census tract</b>	<b>Annual Bike Trips</b>	<b>Avg. Weekly Bike Trips</b>	<b>Avg. Daily Bike Trips</b>
84.06	69,059	1,328	190
42.00	68,598	1,319	188
111.00	68,083	1,309	187
8.02	67,147	1,291	184
44.00	66,149	1,272	182
101.20	65,231	1,254	179
101.03	64,136	1,233	176
91.00	63,739	1,226	175
100.08	63,398	1,219	174
83.02	62,487	1,202	172
114.98	61,491	1,183	169
89.05	61,045	1,174	168
110.02	60,747	1,168	167
6.06	60,351	1,161	166
7.03	58,390	1,123	160
5.02	56,334	1,083	155
83.01	56,134	1,079	154
39.02	56,008	1,077	154
75.02	55,444	1,066	152
97.01	54,662	1,051	150
43.00	54,387	1,046	149
8.01	53,951	1,038	148
62.00	53,744	1,034	148
16.01	53,489	1,029	147
88.01	53,137	1,022	146
100.07	52,000	1,000	143
101.17	51,613	993	142
101.15	50,976	980	140
78.03	50,444	970	139
54.02	50,440	970	139
39.05	49,399	950	136
82.04	49,340	949	136

<b>Census tract</b>	<b>Annual Bike Trips</b>	<b>Avg. Weekly Bike Trips</b>	<b>Avg. Daily Bike Trips</b>
3.03	48,731	937	134
101.06	48,426	931	133
81.00	48,382	930	133
93.04	47,685	917	131
84.07	47,520	914	131
90.06	47,454	913	130
38.00	47,212	908	130
101.26	46,542	895	128
65.00	46,209	889	127
7.04	45,929	883	126
39.01	45,739	880	126
99.02	45,470	874	125
54.01	45,049	866	124
76.02	44,989	865	124
78.02	44,425	854	122
108.00	44,236	851	122
101.14	44,082	848	121
4.07	44,077	848	121
82.01	43,390	834	119
112.02	43,360	834	119
77.03	43,353	834	119
82.03	42,519	818	117
89.02	42,442	816	117
2.08	42,181	811	116
51.00	42,154	811	116
102.03	41,860	805	115
3.04	41,429	797	114
36.02	41,397	796	114
1.03	41,235	793	113
103.00	41,197	792	113
1.07	41,096	790	113
27.01	40,700	783	112

<b>Census tract</b>	<b>Annual Bike Trips</b>	<b>Avg. Weekly Bike Trips</b>	<b>Avg. Daily Bike Trips</b>
100.05	40,609	781	112
70.01	40,571	780	111
9.01	40,519	779	111
77.01	39,594	761	109
24.01	39,456	759	108
41.01	39,420	758	108
84.05	39,073	751	107
85.01	38,276	736	105
113.00	38,103	733	105
89.01	37,928	729	104
2.03	37,920	729	104
66.01	37,836	728	104
90.03	37,807	727	104
53.01	37,516	721	103
4.06	37,157	715	102
107.02	37,034	712	102
57.04	36,344	699	100
70.02	36,309	698	100
83.03	36,280	698	100
50.01	35,799	688	98
100.06	35,783	688	98
53.02	35,584	684	98
2.01	34,890	671	96
95.02	34,580	665	95
52.02	34,457	663	95
47.02	34,455	663	95
6.04	34,388	661	94
12.02	34,343	660	94
77.02	34,244	659	94
67.01	34,177	657	94
25.00	34,140	657	94
5.01	34,085	655	94

<b>Census tract</b>	<b>Annual Bike Trips</b>	<b>Avg. Weekly Bike Trips</b>	<b>Avg. Daily Bike Trips</b>
100.02	33,866	651	93
68.00	33,311	641	92
58.02	33,240	639	91
16.02	33,083	636	91
60.01	32,792	631	90
71.00	32,623	627	90
12.03	32,491	625	89
2.05	32,336	622	89
1.04	31,730	610	87
63.01	31,543	607	87
76.04	31,317	602	86
69.00	31,314	602	86
9.02	30,982	596	85
49.02	30,920	595	85
109.00	30,816	593	85
58.01	30,362	584	83
93.05	30,114	579	83
55.02	29,723	572	82
96.00	29,604	569	81
49.01	29,554	568	81
13.02	29,272	563	80
74.00	29,224	562	80
115.00	29,060	559	80
94.00	29,025	558	80
2.02	28,911	556	79
52.01	28,788	554	79
4.04	28,757	553	79
57.03	28,654	551	79
4.01	28,638	551	79
100.01	28,568	549	78
6.02	28,538	549	78
17.03	28,062	540	77

<b>Census tract</b>	<b>Annual Bike Trips</b>	<b>Avg. Weekly Bike Trips</b>	<b>Avg. Daily Bike Trips</b>
60.02	27,955	538	77
6.03	27,814	535	76
5.03	27,666	532	76
57.01	27,648	532	76
6.01	27,622	531	76
55.01	27,528	529	76
61.02	27,378	526	75
3.01	27,264	524	75
66.02	27,236	524	75
63.02	26,684	513	73
84.09	26,221	504	72
46.01	26,152	503	72
59.03	26,094	502	72
22.02	26,014	500	71
47.01	25,983	500	71
85.02	25,646	493	70
39.04	25,544	491	70
80.00	25,417	489	70
13.01	25,249	486	69
10.02	25,162	484	69
61.01	24,868	478	68
1.05	24,621	473	68
26.00	24,494	471	67
24.02	24,355	468	67
40.00	24,205	465	66
92.00	23,962	461	66
10.01	23,957	461	66
6.05	23,793	458	65
10.03	23,788	457	65
23.00	23,775	457	65
110.01	23,753	457	65
101.11	23,749	457	65



<b>Census tract</b>	<b>Annual Bike Trips</b>	<b>Avg. Weekly Bike Trips</b>	<b>Avg. Daily Bike Trips</b>
1.06	23,632	454	65
47.03	23,492	452	65
50.02	23,476	451	64
4.08	23,090	444	63
4.03	22,983	442	63
10.04	22,953	441	63
11.02	22,898	440	63
64.02	22,894	440	63
59.01	22,809	439	63
59.04	22,449	432	62
64.03	21,965	422	60
105.00	21,769	419	60
56.00	21,725	418	60
99.03	21,656	416	59
11.01	21,487	413	59
2.04	21,475	413	59
2.06	21,396	411	59
59.02	20,823	400	57
12.04	20,665	397	57
11.04	20,265	390	56
14.01	20,081	386	55
46.02	19,951	384	55
67.02	19,818	381	54
64.01	19,669	378	54
22.01	19,562	376	54
95.01	19,460	374	53
112.01	19,430	374	53
15.02	19,207	369	53
18.02	18,600	358	51
29.00	18,597	358	51
4.05	18,124	349	50
31.00	18,087	348	50

<b>Census tract</b>	<b>Annual Bike Trips</b>	<b>Avg. Weekly Bike Trips</b>	<b>Avg. Daily Bike Trips</b>
9.03	17,634	339	48
11.03	17,039	328	47
17.01	16,643	320	46
73.00	16,619	320	46
20.01	16,486	317	45
99.01	16,482	317	45
79.02	16,392	315	45
30.01	16,363	315	45
76.03	15,983	307	44
20.03	15,854	305	44
21.00	15,433	297	42
18.03	15,425	297	42
97.02	15,378	296	42
79.01	15,368	296	42
41.02	15,145	291	42
76.01	13,899	267	38
99.04	13,770	265	38
19.03	13,597	261	37
39.06	13,422	258	37
19.04	13,194	254	36
102.01	13,047	251	36
19.01	13,007	250	36
14.02	12,928	249	36
72.00	12,492	240	34
45.00	12,439	239	34
20.04	12,380	238	34
15.01	12,351	238	34
75.01	12,040	232	33
27.02	11,865	228	33
18.01	11,780	227	32
4.02	11,688	225	32
17.02	10,694	206	29

<b>Census tract</b>	<b>Annual Bike Trips</b>	<b>Avg. Weekly Bike Trips</b>	<b>Avg. Daily Bike Trips</b>
28.00	10,465	201	29
3.02	9,862	190	27
36.01	9,476	182	26
1.08	9,316	179	26
34.00	9,246	178	25
101.24	7,345	141	20
89.04	7,048	136	19
106.02	7,043	135	19
104.00	6,642	128	18
37.02	6,113	118	17
75.03	4,412	85	12
78.01	4,201	81	12
37.01	2,476	48	7
45.99	1,272	24	3
48.00	571	11	2
37.99	153	3	0
116.98	0	0	0

**Bicycle Trip Generation  
Dade County Census Tracts  
Ordered by Census Tract**

<b>Census tract</b>	<b>Annual Bike Trips</b>	<b>Avg. Weekly Bike Trips</b>	<b>Avg. Daily Bike Trips</b>
1.03	41,235	793	113
1.04	31,730	610	87
1.05	24,621	473	68
1.06	23,632	454	65
1.07	41,096	790	113
1.08	9,316	179	26
2.01	34,890	671	96
2.02	28,911	556	79
2.03	37,920	729	104
2.04	21,475	413	59
2.05	32,336	622	89
2.06	21,396	411	59
2.07	70,385	1,354	193
2.08	42,181	811	116
3.01	27,264	524	75
3.02	9,862	190	27
3.03	48,731	937	134
3.04	41,429	797	114
4.01	28,638	551	79
4.02	11,688	225	32
4.03	22,983	442	63
4.04	28,757	553	79
4.05	18,124	349	50
4.06	37,157	715	102
4.07	44,077	848	121
4.08	23,090	444	63
5.01	34,085	655	94

<b>Census tract</b>	<b>Annual Bike Trips</b>	<b>Avg. Weekly Bike Trips</b>	<b>Avg. Daily Bike Trips</b>
5.02	56,334	1,083	155
5.03	27,666	532	76
6.01	27,622	531	76
6.02	28,538	549	78
6.03	27,814	535	76
6.04	34,388	661	94
6.05	23,793	458	65
6.06	60,351	1,161	166
7.01	149,866	2,882	412
7.03	58,390	1,123	160
7.04	45,929	883	126
8.01	53,951	1,038	148
8.02	67,147	1,291	184
9.01	40,519	779	111
9.02	30,982	596	85
9.03	17,634	339	48
10.01	23,957	461	66
10.02	25,162	484	69
10.03	23,788	457	65
10.04	22,953	441	63
11.01	21,487	413	59
11.02	22,898	440	63
11.03	17,039	328	47
11.04	20,265	390	56
12.02	34,343	660	94
12.03	32,491	625	89
12.04	20,665	397	57
13.01	25,249	486	69
13.02	29,272	563	80
14.01	20,081	386	55
14.02	12,928	249	36
15.01	12,351	238	34

<b>Census tract</b>	<b>Annual Bike Trips</b>	<b>Avg. Weekly Bike Trips</b>	<b>Avg. Daily Bike Trips</b>
15.02	19,207	369	53
16.01	53,489	1,029	147
16.02	33,083	636	91
17.01	16,643	320	46
17.02	10,694	206	29
17.03	28,062	540	77
18.01	11,780	227	32
18.02	18,600	358	51
18.03	15,425	297	42
19.01	13,007	250	36
19.03	13,597	261	37
19.04	13,194	254	36
20.01	16,486	317	45
20.03	15,854	305	44
20.04	12,380	238	34
21	15,433	297	42
22.01	19,562	376	54
22.02	26,014	500	71
23	23,775	457	65
24.01	39,456	759	108
24.02	24,355	468	67
25	34,140	657	94
26	24,494	471	67
27.01	40,700	783	112
27.02	11,865	228	33
28	10,465	201	29
29	18,597	358	51
30.01	16,363	315	45
30.02	71,406	1,373	196
31	18,087	348	50
34	9,246	178	25
36.01	9,476	182	26

<b>Census tract</b>	<b>Annual Bike Trips</b>	<b>Avg. Weekly Bike Trips</b>	<b>Avg. Daily Bike Trips</b>
36.02	41,397	796	114
37.01	2,476	48	7
37.02	6,113	118	17
37.99	153	3	0
38	47,212	908	130
39.01	45,739	880	126
39.02	56,008	1,077	154
39.04	25,544	491	70
39.05	49,399	950	136
39.06	13,422	258	37
40	24,205	465	66
41.01	39,420	758	108
41.02	15,145	291	42
42	68,598	1,319	188
43	54,387	1,046	149
44	66,149	1,272	182
45	12,439	239	34
45.99	1,272	24	3
46.01	26,152	503	72
46.02	19,951	384	55
47.01	25,983	500	71
47.02	34,455	663	95
47.03	23,492	452	65
48	571	11	2
49.01	29,554	568	81
49.02	30,920	595	85
50.01	35,799	688	98
50.02	23,476	451	64
51	42,154	811	116
52.01	28,788	554	79
52.02	34,457	663	95
53.01	37,516	721	103

<b>Census tract</b>	<b>Annual Bike Trips</b>	<b>Avg. Weekly Bike Trips</b>	<b>Avg. Daily Bike Trips</b>
53.02	35,584	684	98
54.01	45,049	866	124
54.02	50,440	970	139
55.01	27,528	529	76
55.02	29,723	572	82
56	21,725	418	60
57.01	27,648	532	76
57.03	28,654	551	79
57.04	36,344	699	100
58.01	30,362	584	83
58.02	33,240	639	91
59.01	22,809	439	63
59.02	20,823	400	57
59.03	26,094	502	72
59.04	22,449	432	62
60.01	32,792	631	90
60.02	27,955	538	77
61.01	24,868	478	68
61.02	27,378	526	75
62	53,744	1,034	148
63.01	31,543	607	87
63.02	26,684	513	73
64.01	19,669	378	54
64.02	22,894	440	63
64.03	21,965	422	60
65	46,209	889	127
66.01	37,836	728	104
66.02	27,236	524	75
67.01	34,177	657	94
67.02	19,818	381	54
68	33,311	641	92
69	31,314	602	86



<b>Census tract</b>	<b>Annual Bike Trips</b>	<b>Avg. Weekly Bike Trips</b>	<b>Avg. Daily Bike Trips</b>
70.01	40,571	780	111
70.02	36,309	698	100
71	32,623	627	90
72	12,492	240	34
73	16,619	320	46
74	29,224	562	80
75.01	12,040	232	33
75.02	55,444	1,066	152
75.03	4,412	85	12
76.01	13,899	267	38
76.02	44,989	865	124
76.03	15,983	307	44
76.04	31,317	602	86
77.01	39,594	761	109
77.02	34,244	659	94
77.03	43,353	834	119
78.01	4,201	81	12
78.02	44,425	854	122
78.03	50,444	970	139
79.01	15,368	296	42
79.02	16,392	315	45
80	25,417	489	70
81	48,382	930	133
82.01	43,390	834	119
82.03	42,519	818	117
82.04	49,340	949	136
83.01	56,134	1,079	154
83.02	62,487	1,202	172
83.03	36,280	698	100
84.04	87,811	1,689	241
84.05	39,073	751	107
84.06	69,059	1,328	190

<b>Census tract</b>	<b>Annual Bike Trips</b>	<b>Avg. Weekly Bike Trips</b>	<b>Avg. Daily Bike Trips</b>
84.07	47,520	914	131
84.08	73,817	1,420	203
84.09	26,221	504	72
85.01	38,276	736	105
85.02	25,646	493	70
86	71,049	1,366	195
87	71,836	1,381	197
88.01	53,137	1,022	146
88.02	85,511	1,644	235
89.01	37,928	729	104
89.02	42,442	816	117
89.04	7,048	136	19
89.05	61,045	1,174	168
90.03	37,807	727	104
90.04	176,989	3,404	486
90.05	144,173	2,773	396
90.06	47,454	913	130
91	63,739	1,226	175
92	23,962	461	66
93.02	130,996	2,519	360
93.03	136,042	2,616	374
93.04	47,685	917	131
93.05	30,114	579	83
94	29,025	558	80
95.01	19,460	374	53
95.02	34,580	665	95
96	29,604	569	81
97.01	54,662	1,051	150
97.02	15,378	296	42
98	83,065	1,597	228
99.01	16,482	317	45
99.02	45,470	874	125

<b>Census tract</b>	<b>Annual Bike Trips</b>	<b>Avg. Weekly Bike Trips</b>	<b>Avg. Daily Bike Trips</b>
99.03	21,656	416	59
99.04	13,770	265	38
100.01	28,568	549	78
100.02	33,866	651	93
100.05	40,609	781	112
100.06	35,783	688	98
100.07	52,000	1,000	143
100.08	63,398	1,219	174
101.03	64,136	1,233	176
101.06	48,426	931	133
101.11	23,749	457	65
101.14	44,082	848	121
101.15	50,976	980	140
101.16	144,862	2,786	398
101.17	51,613	993	142
101.18	71,114	1,368	195
101.19	179,469	3,451	493
101.2	65,231	1,254	179
101.21	129,051	2,482	355
101.22	113,379	2,180	311
101.23	176,560	3,395	485
101.24	7,345	141	20
101.25	170,199	3,273	468
101.26	46,542	895	128
101.27	72,575	1,396	199
101.28	71,318	1,372	196
102.01	13,047	251	36
102.02	99,011	1,904	272
102.03	41,860	805	115
103	41,197	792	113
104	6,642	128	18
105	21,769	419	60

<b>Census tract</b>	<b>Annual Bike Trips</b>	<b>Avg. Weekly Bike Trips</b>	<b>Avg. Daily Bike Trips</b>
106.01	69,556	1,338	191
106.02	7,043	135	19
106.03	78,085	1,502	215
107.01	77,259	1,486	212
107.02	37,034	712	102
108	44,236	851	122
109	30,816	593	85
110.01	23,753	457	65
110.02	60,747	1,168	167
111	68,083	1,309	187
112.01	19,430	374	53
112.02	43,360	834	119
113	38,103	733	105
114.98	61,491	1,183	169
115	29,060	559	80
116.98	0	0	0

**APPENDIX D:  
TRANSIT SYSTEMS CONTACTED**

**LIST OF INTERVIEWEES**

*Phoenix*

*City of Phoenix Public Transit Department*  
Mike Nevarez, Transit Operations Manager

*Portland*

*Tri-County Metropolitan Transportation District of Oregon*  
Richard L. Gerhart, P.E., Director, Operations Planning & Scheduling  
Steve Gillmer, Customer Service Specialist  
Linda Williams, Administrative Secretary

*Sacramento*

*Sacramento Planning Department*  
Kirk Schneider, Bicycle and Pedestrian Coordinator

*Sacramento Regional Transit*

Sheryl Patterson, Attorney

*Santa Clara County Transportation Agency*

Dennis Moshon, Marketing Manager  
Sylvia Alvarez, Planner III

*Seattle*

*King County Department of Metropolitan Services*  
METRO Transit Department  
Peggy A. Renfrow, Operations  
Dave Lilly, Supervisor, East Base Vehicle Maintenance

**FLORIDA CONTACTS**

*Broward County Transit*

Mark Horowitz, Broward County Bicycle Coordinator

*HARTline (Hillsborough County)*

Chad Reese, Planning Analyst

*LeeTran (Lee County)*

Moises Galarza, Operations Supervisor

*Palm Beach County*  
Bill Philips, Bicycle/Pedestrian Coordinator

*RTS (Gainesville)*  
George Boyle, Program Manager

*TALTRAN (Tallahassee)*  
Noel Brown

**APPENDIX E:  
METRO-DADE RESOURCE PERSONS**

Danny Alvarez, MDTA Deputy Director  
Oscar Camejo, Senior Planner  
Vernon Clarke, General Superintendent  
Michael Decossio, Interim Marketing Manager  
Judy Emerson, Transit Economic Development Specialist  
Bruce Epperson, Senior Planner  
Wilson Fernandez, Principal Planner, Transit System Development  
David Fialkoff, Chief of Service Planning and Scheduling Division  
Marvin Hinton, Assistant General Superintendent of Bus Operations  
Jeffrey Hunter, Bicycle/Pedestrian Coordinator  
Suzie LaPlant, Transit Planning Section Supervisor  
Don McElroy, Chief of Transit Safety and Assurance  
Jorge Pubillones, Technical and Special Projects Administrator  
Melissa Rolle-Scott, Transit Safety Officer  
Duncan Smith, Transit Maintenance Supervisor  
Robert Snyder, General Superintendent





APPENDIX F:  
HARTLINE INSTRUCTIONAL BROCHURE

Sponsored by:

**HARTline**  
Hillsborough Area Regional Transit

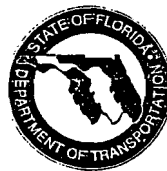

Federal Transit  
Administration



**Put Your Bike  
Where Your Bus Is!**

**Organizational Involvement:**

- Florida Department of Transportation (FDOT)
- Hillsborough County
- Hillsborough County Bicycle Advisory Committee (BAC)
- Metropolitan Planning Organization (MPO)
- Tampa Downtown Partnership
- University of South Florida (USF)
- Westshore Alliance
- YMCA

**Permit Facts**

**Permit guidelines**

- If permit is revoked, training must be repeated and fee must be paid again.
- The policy for revoking permits will follow the same procedures as the HARTsaver Pass Program.

**Bus Operator responsibility for checking the permit**

- Show permit before loading bicycle.
- Show permit at curbside front window.

**Types of bikes permitted to load**

- Maximum of 2 bikes per bike rack.
- Single seat, two wheeled bikes only.
- Bikes as small as 16" will fit bike rack.

**Age requirement**

- **Regular permit:** age 12 years and older.
- **Youth permit:** age 8-11 years; needs a parent's signature on file.

**Training**

- Training must be completed before permit is issued.
- Training will consist of a five-minute video and proper use of the bike rack.

**Bikes on Buses Program Rules and Regulations**

It is the responsibility of the cyclist to read and comply with the following:  
The permit card cost is \$1.00. Bikes are permitted on HARTline vehicles that are equipped with exterior-mounted bike racks. Bikes are not permitted inside buses. Bikes on the Marion Street Transit Parkway, HARTline Northern Terminal and Park-N-Ride locations must be walked. A copy of current rules and regulations shall be maintained on file at HARTline facilities and available for customers.

**Rules of Program Use:**

- I. A maximum of two bicycles may be loaded on buses equipped with a bike rack. Only single seat, two-wheel bicycles will be permitted on HARTline vehicles; motor-powered vehicles not allowed.
- II. Permits are issued after completion of a training/orientation program; a permit is for the sole use of the applicant and is not transferable.
- III. Regular permits will only be issued to applicants age 12 or older. Youth permits will be issued to applicants age 8-11. Any one under the age of 18 must be accompanied by an adult during the permitting process. Proof of age will be required prior to purchase of the permit. Each youth, with a valid permit, must be accompanied by an adult (18 years or older). An adult accompanying a youth must carry proof of age.

- IV. The permit must be shown to the Bus Operator prior to loading your bike. Loading and securement of bikes on front-mounted bike racks is the responsibility of the cyclist. Follow these procedures:
  - i. Show the Bus Operator your permit through the curbside front window, load and secure your bike on the front-mounted rack, enter the bus, pay your fare, and tell the Bus Operator where you will be unloading.
  - ii. Before leaving the bus, tell the Bus Operator you will be unloading your bike.
  - iii. After removing your bike, fold up the rack if it is empty.
  - iv. If a bike rack is inoperative or broken, notify the Bus Operator and wait for the next available bike-rack equipped bus.
- V. Permits are the sole property of HARTline, and will be subject to confiscation from the cyclist, by any HARTline personnel, if the cyclist violates the rules and regulations of the bike program.
- VI. HARTline is not liable for damage to the bicycle and other property connected with the bicycle, except in the event that HARTline is found to be negligent or at fault in an accident. Theft, damage, injury loading and unloading, acts by third parties, and all other related incidents are solely the responsibility of the patron/cyclist and not HARTline.

