

sketch
1922
design book
1922

1/15
m/24

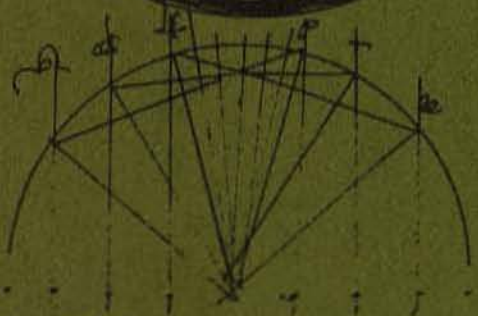

the line
the line
the line
the line
the line

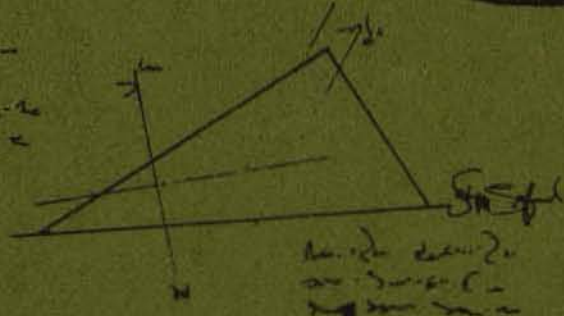

the line
the line
the line

e/20
200

bikeway · system · planning · & · design · manual

BNA

LIBRARY COPY

DO NOT REMOVE

**BIKEWAY SYSTEM PLANNING
& DESIGN MANUAL**

**SPONSORED BY THE
WASHINGTON TRAFFIC
SAFETY COMMISSION**

The Seattle Engineering Department

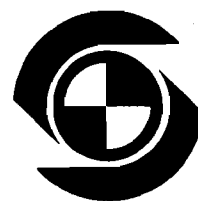

BMA

LIBRARY COPY

DO NOT REMOVE

Accession # 201

BIKEWAY SYSTEM PLANNING
& DESIGN MANUAL

SPONSORED BY THE
**WASHINGTON TRAFFIC
SAFETY COMMISSION**

The Seattle Engineering Department

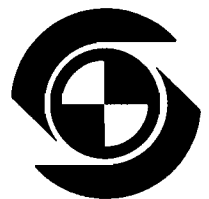

Accession # 201

BMA
LIBRARY COPY
DO NOT REMOVE



BIKEWAY SYSTEM PLANNING & DESIGN MANUAL

CITY OF SEATTLE

Wes Uhlman, MAYOR

COUNCIL

Sam Smith, President

George Benson

Tim Hill

Paul Kraabel

Phyllis Lamphere

Wayne Larkin

John Miller

Randy Revelle

Jeannette Williams

Engineering Department

Paul A. Wiatrak, P.E.

City Engineer

Traffic and Transportation Division

William G. van Gelder, P.E.

City Traffic Engineer

August 1975



Contributing Staff, Traffic and Transportation Division:

Richard J. Carlson, Task Director

Robert D. Theisen, Project Manager

Text

Joseph R. Beck

Richard J. Carlson

Donald H. Carr

Robert D. Theisen

Graphics

Glenn K. Ono

Ronald B. Scharf, Utility Design Division

Cover Design

Michelle L. Stafford



ACKNOWLEDGEMENTS

This project is a part of the Washington Traffic Safety Program and was made possible through the support of the Washington Traffic Safety Commission and the National Highway Traffic Safety Administration.

The authors wish to express their gratitude to the following persons for their review and helpful advice on this publication:

William G. van Gelder, P.E., City Traffic Engineer,
City of Seattle
Philip M. Buswell, Principal Assistant, City Engineer
- Engineering, City of Seattle
George E. Fies, P.E., Assistant Traffic Engineer,
City of Seattle
Barry W. Fairfax, P.E., Assistant Traffic Engineer,
City of Seattle
Herbert W. Johnson, Transportation Systems Designer,
City of Seattle
Josh Lehman, Doctoral Candidate, University of
Washington

Special thanks are extended to Virginia Mays, and her helpers Lora Fies and Karen Karatzas, for efficient and dedicated preparation of typed copy.

Robert Mrogan's assistance in gathering together the finished illustrations and text, and providing support during the printing operation, was very beneficial.

The authors gratefully acknowledge the support of the Washington Traffic Safety Commission through its Director, Clifford E. Aden and its Assistant Director, Ronald MacDonald, without whose encouragement and financial assistance this manual would not have been written.



The opinions, findings, and conclusions expressed in this publication are those of the authors and not necessarily those of the State of Washington or the National Highway Traffic Safety Administration.



TABLE OF CONTENTS

	<u>PAGE</u>
I. Introduction	1
II. Community Perspective	5
A. Needs & Wants	
B. Organization	
C. Goals and Objectives	
III. Data Inventory & Forecasts	11
IV. System Development	37
V. System Initiation	47
A. System Prioritization	
B. Alternative Design Concept Development	
C. Analysis of Alternates	
D. Design Concept Selection	
VI. Bikeway Design	59
VII. Bikeway Evaluation	127
Appendix	133
Bibliography	145



LIST OF FIGURES

<u>FIGURE</u>		<u>PAGE</u>
I- 1	Bikeway System Development Process	3
III- 1	Typical Bicycle Cordon Count	14
III- 2	Bicycle Volume Curves	16
III- 3	Bicycle Flow Map	17
III- 4	Hypothetical Desire Line Diagram	20
III- 5	Hypothetical "Starburst" Pattern	21
III- 6	Bicycle Operator Questionnaire	23
III- 7	Bicycle Operator Questionnaire	24
III- 8	Retail Sales Questionnaire	25
III- 9	Typical Legal/Illegal Bicycle Left-Turn Maneuvers	27
III-10	Motor Vehicle Traffic Flow Map	29
III-11	Travel Behavior Inventory	31
III-12	Bicycle Trip Attraction	32
III-13	Bikeway Service Areas	33
IV- 1	Combination Planform System Network	39
IV- 2	Grid Planform	40
IV- 3	Radial Planform	41
IV- 4	Loop Planform	42
IV- 5	Linear Planform	43
IV- 6	Linear Planform System Network	44
V- 1	Scalar Rating Matrix	53
V- 2	Cost-Effectiveness Diagram	55
VI- 1	Bike Street	62



LIST OF FIGURES

<u>FIGURE</u>		<u>PAGE</u>
VI- 2	Bike Lane/Parking Options	63
VI- 3	Left Lane Bikeway Placement	64
VI- 4	Bike Lane Options	65
VI- 5	Two Directional Bikeway	66
VI- 6	Two Directional Bikeway Accident History (The Netherlands)	67
VI- 7	Potential Sidewalk Bikeway Conflicts	70
VI- 8	Sight Clearances	73
VI- 9	Radius of Curvature/Speed Relationship	75
VI-10	Super elevation Effect on Speed/Radius Relationship	76
VI-11	Curve Widening	77
VI-12	Length of Desirable Grade	79
VI-13	Bicycle Operating Space	81
VI-14	Bike-Pedestrian Space Requirements	84
VI-15	Bicycle Lane and Path Capacity	85
VI-16	Standard Roadway Configurations	87
VI-17	Standard Roadway Configurations	88
VI-18	Typical Structural Sections for Bikeway Paths	89
VI-19	Elevated Path	90
VI-20	Inlet Grate Warning Stripes	91
VI-21	On Street Bikeway-Typical Intersections	93
VI-22	Sidewalk Bikeway-Typical Intersections	94
VI-23	Bike Path-Typical Intersections	95



LIST OF FIGURES

<u>FIGURE</u>		<u>PAGE</u>
VI-24	Potential Points of Conflict	96
VI-25	Typical Legal/Illegal Bicycle Left Turn Maneuvers	97
VI-26	Intersection Channelization-Thru Bikeway	99
VI-27	Intersection Channelization-Bikeway Left Turn	100
VI-28	Bicycle Intersection Approach Lanes	101
VI-29	Control Methods-Turning Motor Vehicles	102
VI-30	Bike Lanes/Bike Path Transitions	104
VI-31	Sidewalk Path/Bike Lane Transitions	105
VI-32	Sidewalk Path/Bike Lane Transition Midblock	107
VI-33	Deceleration Methods	108
VI-34	Bikeway/Railroad Crossings	110
VI-35	Rubberized Railroad Crossing	111
VI-36	Grade Separation Structures	112
VI-37	Standard Bikeway Signs	114
VI-38	Bikeway Sign	114
VI-39	Special Bikeway Signs	115
VI-40	Sign Development	116
VI-41	Traffic Control Buttons	118
VI-42	"Bicycle Safe" Curbing	120
B- 1	Acceptable Lean Angle-Design Bicycle	141
B- 2	Comparison of Radii Selection Curves	143



LIST OF TABLES

<u>TABLE NUMBER</u>		<u>PAGE</u>
V- 1	Example: Aggregated Effectiveness	54
VI- 1	Grade Recommendations	78
VI- 2	Bikeway Surface Widths	80
VI- 3	Obstruction Clearance Allowance	82
VI- 4	Minimum Motor Vehicle Travel Lane Widths	83



FORWARD

This publication is the result of a serious concern by the State of Washington Traffic Safety Commission for reducing accidents involving bicyclists. One method which appears to have promise toward achieving this goal is the provision of designated bikeways. The City of Seattle Engineering Department was requested to develop a manual which would be a significant advancement in the state of the art of bikeway planning and design literature and which would have application in urban areas throughout the State.

The information presented here represents much of what has been gathered by the authors through visits to communities with completed bikeways, consultations with persons involved in this field, review of available literature, and experience with implementing a local bikeway system.

It is the hope of the authors that this manual will have wide application within the State of Washington and across the country and add to the growing store of bikeway knowledge.



CHAPTER I

INTRODUCTION

CHAPTER I

INTRODUCTION

During the last decade the use of bicycles in American cities has increased dramatically for both recreational and transportational purposes. The expanding attraction of the bicycle as a mode of transportation has been reflected in the continuing gain in sales. The retail sales volume of new bicycles during 1971 exceeded that of automobiles for the first time in over fifty years (1). This latest "boom" in bicycle usage began during a period of concern by many people with the desire for an improvement in their physical environment, the tendency toward participatory recreational activities, a desire for physical fitness, and a growing awareness of the bicycle's mobility, energy efficiency, convenience and low cost operation. The retail sales of bicycles was given an additional impetus during late 1973 and early 1974 with the threat of a continuing scarcity of petroleum products.

The greater numbers of bicycles in our communities, and their more frequent use on our streets have caused increasing conflicts with motor vehicles. The motorist, using systems often utilized beyond capacity, now finds he is competing for roadway space with the bicycle operator. This situation, plus such factors as frequent lack of adherence to bicycle regulations by the bicycle operator and the minimal bicycling knowledge of most motorists, has resulted in growing numbers of injuries and fatalities to bicyclists each year (2,3).

Federal, State and local governments, having recognized the need for improved bicycle safety, have begun programs aimed at bicycle operator education, bicycle awareness by the general public, and the formation of systems of bikeways and bicycle routes. In 1972 the State of Washington passed an act which among other things authorized expenditures of money from the Motor Vehicle Fund for "planning, accomodation, establishment, and maintenance of" bicycle facilities (4). The State's encouragement was amplified in 1974 when a law was passed requiring the consideration and establishment of bicycle routes by the Urban Arterial Board (5). The Federal Government in the Federal Aid Highway Act of 1973 included a section on Bicycle Transportation and Pedestrian Walkways "to encourage the multiple use of highway rights of way "utilizing matching Federal monies. Grants have been made by various agencies of the United States Government for bicycle safety studies and bikeway planning studies. The work on this manual was supported with National Highway Traffic Safety Administration funds through the Washington Traffic Safety Commission.

Within most Federal and State laws providing funding for bikeways there is the requirement that the applicant agency have an approved comprehensive bikeway plan. This plan assures that a framework has been established for logical and coherent bikeway system development. It

serves as a policy statement by the local elected officials regarding bicycle facility improvements and, as such, acts as a model for citizen review during system implementation (6). It functions as a directive to the local governmental departments responsible for bikeway planning and design. Through the structured approach of a comprehensive bikeway plan, a community can more efficiently invest its citizens' money in a bikeway system.

The purpose of this manual is to assist urban communities in the development and implementation of a bikeway system through a process consisting of a series of interdependent steps. The flow chart shown in Figure I-1 illustrates the basic activities necessary to accomplish this goal. The following chapters explain the individual steps of the planning process and identify the techniques which aid in bikeway system formulation, implementation, and evaluation.

Although this manual was written to facilitate bikeway development in large complex urban situations, its principles can be very helpful to smaller communities.

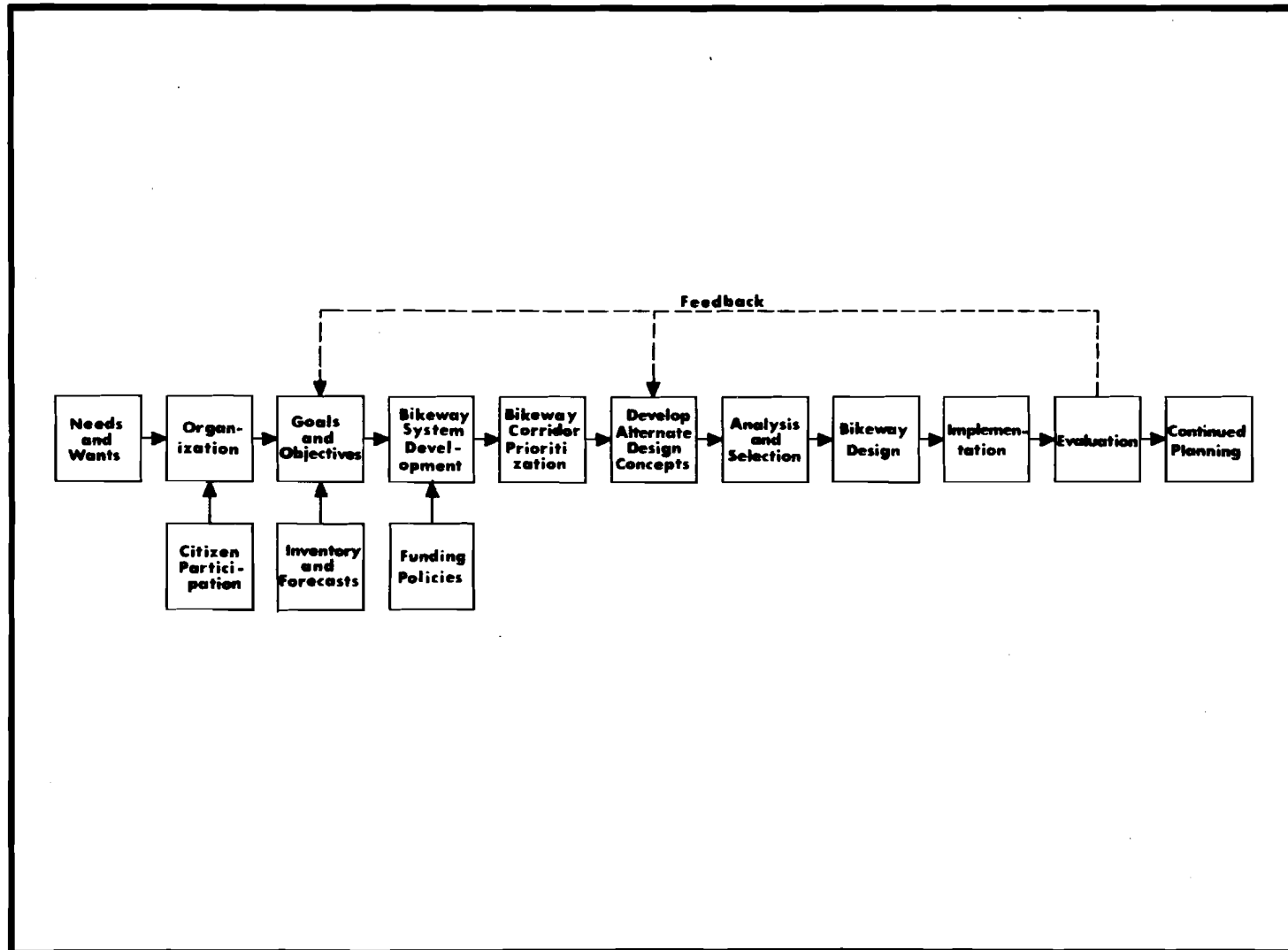

3

Figure I-1 BIKEWAY SYSTEM DEVELOPMENT PROCESS

REFERENCES (CHAPTER 1)

1. Bicycle Institute of America, Some Facts About The Current Bike Explosion, 1972, cited by Barton-Aschman Associates, Incorporated, The Bicycle, Atlanta Metropolitan Region, (St. Paul, Minnesota, July, 1973), p.7.
2. Topish, Lloyd M. and Roger B. Lytell, A Study of Bicycle-Motor Vehicle Accidents, A Report for the City of Santa Barbara, (Santa Barbara, California, June, 1973), p.19.
3. Seattle, City of, Engineering Department, Bicycle Safety Study, (Seattle, Washington, May, 1975), pp. 55-69.
4. SB 355, State of Washington, 2nd Ex. Session (1972), Chapter 47.30 RCW.
5. HB 1295, State of Washington, (1974).
6. Hamill, James P., "Planning and Development of Bikeway Systems", Management Information Service Report, (Washington: International City Management Association, April, 1973), p.3.

CHAPTER II

COMMUNITY PERSPECTIVE

CHAPTER II
COMMUNITY PERSPECTIVE

NEEDS AND WANTS

Before there is planning, there must be a reason or a need. Pleasant paths for bicycle recreation and exercise; convenient routes to parks, downtown, and schools; safer ways to cross highways or get through major intersections; training for young and older bicyclists; changes in community laws; and enforcement measures are all products of human concern or desire. However, the list of community needs and wants will only include the obvious ones unless efforts are made to search out those less apparent. Three areas of investigation are:

1. Unrevealed experience - A prime example is the bicycle accident costs which most communities are experiencing through additional ambulance and medical demands, and the pain and suffering of the injured and their families. Other existing community bicycling experience can also be revealed by the assembly and collection of opinions and facts.
2. Undefined restraints - An undertermined number of bicycle transportation or recreational trips are not undertaken because they appear too inconvenient or hazardous. The inadequacies of safety, convenience, training, equipment, physical facilities, and social acceptance, are all partially inhibitive to the bicycle mode of travel. Many persons are so accustomed to these inhibitions that the restraints may not be recognized.
3. Future demands - The re-emergence of bicycling as an expanding adult form of transportation and recreation is a statewide and national experience. However, each community should assess its own future bicycling activity, considering such local characteristics as climate, terrain, and economic and social trends.

As complete a list as possible of identified needs and wants should be sought, even though some may not presently have applicable solutions. These three areas can best be pursued through the use of qualified professionals.

The list presents a very good idea of where the community's attention should be focused. However, until specific corrective measures and solutions are devised to meet the community's objectives, it will be difficult to establish the order of implementation of the items on the list.

ORGANIZATION

Through political and governmental process needs gain recognition. Government at all levels can help, as can citizen action groups. Local government is not only useful in influencing higher governmental decisions, but is a key to local community determinates. Where local officials do not recognize the need for bicycle facility improvements, or feel that the agency's efforts should be applied to more pressing needs, positive results will require organized citizen action. Although some of the techniques presented in this Manual may require the assistance, or at least the cooperation, of local governments' technical staff, the majority of the basic system planning can be accomplished by an ad-hoc interdisciplinary group. It is left for the reader to determine the availability of local talent.

Once citizens and officials agree that bicycle facilities are important, the planning begins with the appointment of a Project Manager. The Project Manager establishes a framework within which policy decisions can be made, citizen participation can be assured and a technical staff capable of undertaking the study can be assembled. The Project Manager works with the participants in the study. Generally they include interested groups, affected citizens, technical people from the agency's various departments and organizations, and necessary policy groups including the Mayor and the City Council. A system of coordination is established which indicates various review points at different intervals to insure that proper consideration is given to all interests. The degree of involvement depends upon the importance of the activity. Following each activity a decision must be made regarding the course of action to be followed next. The actions available are:

1. Stop the process.
2. Reiterate the process.
3. Take an alternate course.
4. Continue to the next activity.

Thus, for example, if it is felt that during the data inventory insufficient information had been collected, it may be decided to repeat and expand that process phase. The next forward step is not taken until sufficient data has been collected.

Citizens, officials and staff working in concert will result in the most effective bikeway system to meet the community's needs.

The functional operation of the organization should ensure continuity of involvement of all representatives - citizens, planners, and designers - from the beginning of system planning into the implementation phase. Each community must evaluate the total time and effort involved in this "process of decision making" and keep it in perspective. In general, the smaller community may tend to feel a shortage of technical expertise in some areas, but may be able to make sound decisions more readily than the larger community which has a larger staff but also greater community interaction complexities. The formality and refinement of the decision making process appears to increase with the size and complexity of the community.

Many small communities will not have qualified personnel with bikeway planning and design knowledge and may engage a consulting firm to assist them. Some of the skills that are important to obtain are:

1. Knowledge of applied bikeway design techniques and the operational advantages and disadvantages of each method.
2. Familiarity with general Traffic Engineering parameters and, specifically, with the effectiveness of traffic control devices.
3. Actual bikeway planning and design experience. Any previous involvement in bikeway construction or operations should be considered an exceptional qualification.
4. Basic understanding of the general Transportation Planning process.
5. A thorough comprehension of the skills required to bicycle within an urban area, and the operational limitations of the bicycle.
6. The ability to communicate by public speaking and in writing with the citizens and public servants. This capability should also include receptiveness to comments and suggestions of others.

GOALS AND OBJECTIVES

To guide the planning and design process toward a successful outcome, goals and objectives are developed through cooperative efforts of policy and citizen advisory groups with the assistance of the technical staff.

A goal is an idealized end state to which the community strives. Although goals may not be attainable they provide the directions in which a community will move. An objective however, is an outgrowth of a goal which can be achieved and has means of measuring the degree of success (1).

If for example, a goal of a community's bikeway system is to enhance bicycle safety, an objective of each bikeway could be to reduce bicycle/motor vehicle accidents by 30 percent. The resulting history of accident occurrence along the length of a bikeway would provide a measurement of the level of achievement.

The degree of attainment for some objectives can not be measured quantifiably and must rely on a subjective evaluation. A goal of providing an attractive environment for all users could result in an objective to construct as many scenic viewpoints as possible along the bikeway. Whether this had been accomplished or not and if the viewpoints were scenic would depend on each persons individual judgement. One approach to evaluation of achievement level in this case would be to compare the results against alternate approaches that could have been used to foster the same goal.

REFERENCES (CHAPTER II)

1. Thomas, Edwin N. and Joseph L. Schafer, "Strategies for the Evaluation of Alternative Transportation Plans", HRB HWY. Res. Report 96, (Washington: 1970) p. 40.

CHAPTER III

DATA INVENTORY AND FORECASTS

CHAPTER III

DATA INVENTORY AND FORECASTS

The maxim that "any planning which concludes with recommendations for the expenditure of public funds must obviously be based upon fact "(1) applies as well to spending for bicycle facilities as for other community endeavors. However, few cities or towns have sufficient factual information pertinent to bicycling to enable the planner or the elected official to arrive at optimum decisions. A broad spectrum of facts is needed to clearly identify the existing setting in which the bicycles are operated and the characteristics of bicycle usage. Data is also required to provide the basis from which forecasts of future needs and demands can be developed, thereby aiding the logical implementation of the bikeway system and affording a means of measuring the effectiveness of that growth. Additionally, the data collection and analysis process demonstrates to the community and the elected officials that the bikeway plan was prepared in a careful and thorough manner.

The extent of data to be collected, however, is strongly dependent on the size and complexity of the city or town involved in bikeway planning. A regional core city of 500,000 population, for example, must ordinarily gather substantially more and a greater variety of information than a community of 50,000 people in a rural setting. This chapter presents the range of generally accepted transportation planning survey techniques and some new innovations developed to aid in bikeway planning. It also includes a discussion of locally available information regarding the existing transportation systems and urban structure needed in the bikeway planning process. This chapter also presents two theoretical methods for developing forecasts of bicycle volumes; one deals with expected bicycle use in a community when an entire bikeway system has been implemented, while the other technique provides a means for estimating ridership for a proposed individual bikeway.

The scope of the data collection effort pertinent to urban bikeway planning is described within four main categories: Travel Surveys, User Characteristic Surveys, Transportation Network Inventory, and Urban Structure Inventory described in the following four sections. The state of the art of Bicycle Trip Generation Forecasts is covered in the last section.

THE TRAVEL SURVEYS

Travel Surveys are conducted to identify the magnitude and location of bicycle movements, the trip purposes, and the time of day, week, and year when the trips occur. Some methods of gathering this information that have been successful in bicycle data collection are household surveys, roadside interview surveys, cordon counts, bicycle traffic

volume counts, "blank map" surveys, and origin and destination surveys.

Household Surveys

Household Surveys are used to develop travel inventory facts and opinions through direct contact with a sample of households. This can be accomplished by personal interviews in the household or by telephone, through the use of mailed questionnaires, publicly distributed questionnaires, or newspaper surveys. The choice of which method to use is largely dependent upon the amount of funds available to perform and process the survey, the accuracy required, the size of the survey sample, and the time available for obtaining the results.

The personal interview in the home, while having the highest degree of validity of any of the home survey techniques, has the largest cost. Interviews must be set up in advance through telephone contact or by letter with a telephone follow-up. The police in the area being worked must be notified. Persons with the same ethnic background as those being interviewed are generally preferred. Telephone calls to a sample of interviewed homes are required to validate the information obtained. Additional funds have to be spent to process the raw data to the final usable tabulation.

Telephone interview surveys can accomplish many of the results desired in the personal interview. However, the frequency of responses from persons contacted is much lower. The length of the questionnaire must be reduced and the validity of the responses has greater uncertainty, than with personal contact.

In common with the personal and telephone interview surveys, the mailed questionnaire can be directed toward a selected sample of the community's population. This permits the planner the opportunity to draw the strongest inference from the responses of users and non-users of bicycles. In order to insure the largest return from both groups, some questions of mutual concern and high interest should be included in the questionnaire.

Publicly distributed questionnaires and newspaper surveys are the least expensive method of gathering information directly from households. However, these two survey methods and the mailed questionnaire have little control over the timing of the returned information. Additionally, questionnaires which are not drawn to the attention of the household occupants are easily overlooked. The location of distribution points or the placement within a local newspaper can have an influence on the amount of survey sheets returned and the bias of those responding.

Roadside Interview Survey

The roadside interview is the most direct method of obtaining information from bicyclists or from motorists regarding bicyclists. In addition to the answers received from survey questions, much data can be obtained from observation of bicycle operators' behavior and the

interaction between bicycles and motor vehicles.

The interviewer should be positioned to neither impede traffic nor be a safety hazard. Temporary signing along the roadway to alert traffic to the existence of the survey station will assist in smoother traffic flow and increase the possibility of voluntary involvement in the survey. The time period chosen for operation during the day should gain the maximum data with the least disruption to the travel plans of those being interviewed. The most opportune time for the survey will vary between bicycle user types and should be selected to gather the largest amount of information from the subject group.

The roadside interview will often uncover pertinent information beyond the scope of the designed questionnaire.

A major deficiency in this technique is that its use is generally restricted to good bicycling weather. The questionnaire's length must also be limited to that which can be administered within an acceptable delay time. The cost of this type of survey is very dependent upon the volume of bicycle traffic at the chosen survey locations. The information received may only represent the specific corridor or route.

Cordon Count

A cordon count provides a means of measuring the volume of bicycle trips entering and leaving a specific sector of the community. The data obtained helps to define the major corridors being used, the periods of maximum directional flow and the accumulation of bicycles within the cordoned area. The cordon count is performed by placing observers at stations at the perimeter of an activity center or community (i.e. Central Business District, University Campus, recreational facility, neighborhood, etc.) and counting all bicycles entering and leaving during a specified time period. The location and number of stations required is dependent upon the street arrangement of access routes to the encircled area and the degree of accuracy desired in the assembled data. Figure III-1 shows the location of counting stations and the twelve hour inbound volumes for a double cordon count of bicycles.

Although minor variations in the weather will have an important effect on the total commuter bicycle volume measured in a cordon count, these numbers can be factored to correspond to any acceptable bicycling condition. Counts can be made on routes crossing the cordon line during a similar time period to the original cordon count and extrapolated to produce a total bicycle volume for that day. Additional adjustment can be made to compensate for the season or weather. For example, if the inner cordon count illustrated in Figure III-1 was made on a cool, fall day, usable information could be developed for a day more conducive to higher bicycle volumes. Count stations could be placed at three or four of the high bicycle volume streets and a comparison made of the volume for the two counting sessions. This would produce a factor with which the total fall trips could be amplified.

The application of this factoring technique is valid for bicycling groups which follow a predictable travel time pattern. However, before

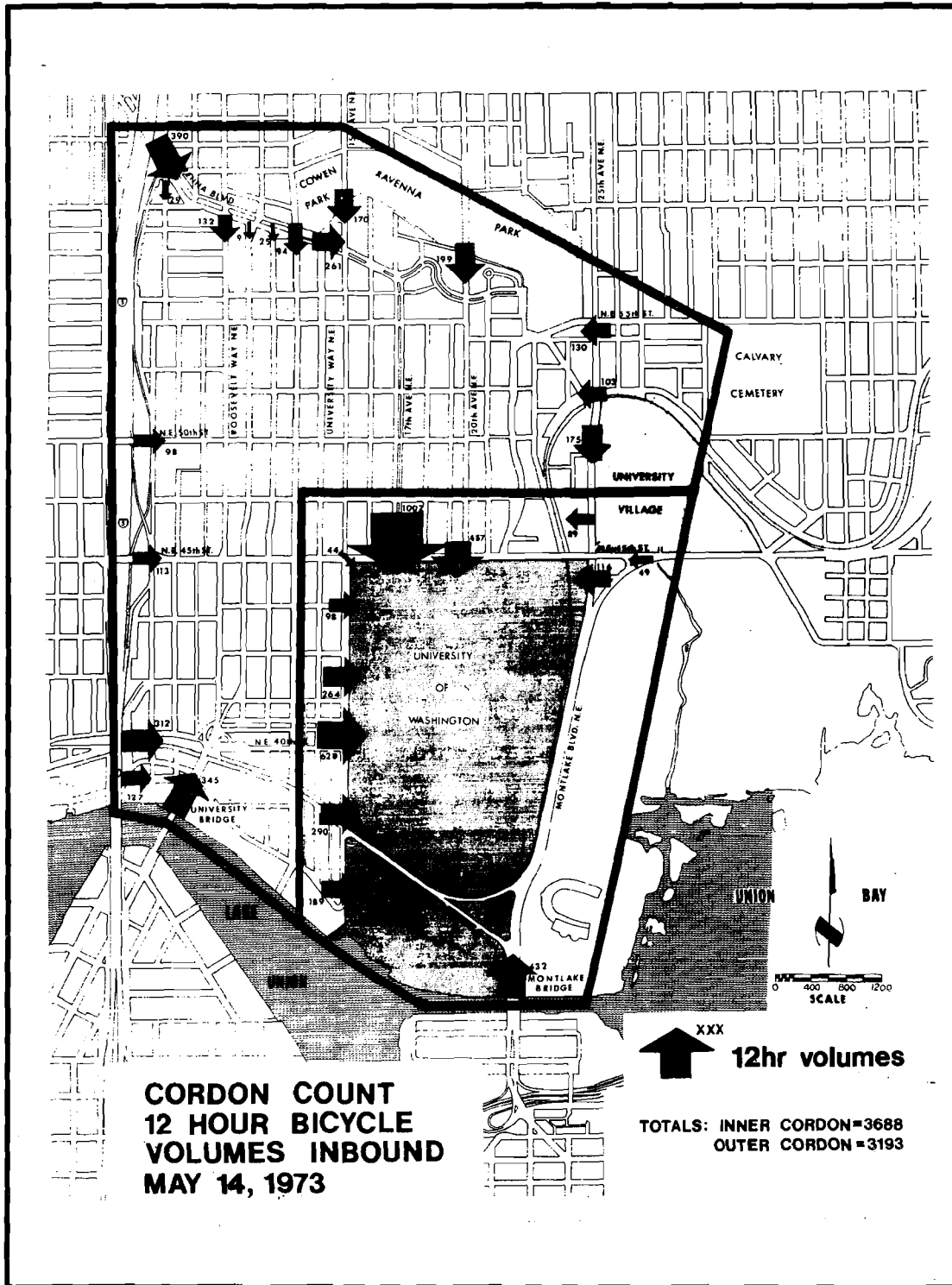

Figure III-1 TYPICAL BICYCLE CORDON COUNT
SOURCE: City of Seattle, Bicycle Safety Study

this method could be used for determining total daily recreational bicycle volumes factors affecting that activity would have to be identified and quantified.

Bicycle Traffic Volume Count

Bicycle traffic volume counts are used to determine the magnitude of hourly and daily volume of bicycle use along a roadway, the time and size of maximum directional flow, and the movements at intersections (Figure III-2). This information is needed when analyzing the possible impacts on the roadway users and the adjacent businesses and homes by the inclusion of a designed bikeway. This data will aid in the proper location of a bikeway within the right of way and also facilitate its design at intersections. Bicycle traffic volume counts taken before and after the installation of a bikeway are a useful measure in determining the effectiveness of such a facility in attracting additional bicycle users.

Bicycle traffic volume counts have importance as isolated numeric data, but also can be aggregated and presented graphically as a bicycle traffic flow map (Figure III-3). This device clearly identifies the principal bicycle operator travel routes. A comparison of the bicycle volumes to that for motor vehicles along the same roadways indicates the rate of exposure of the bicycles on those streets (2). A knowledge of the physical arrangement of the roadway settings and the exposure rate are valuable parameters in understanding the bicycle/motor vehicle accident potential.

Some of the standard methods of counting motor vehicles are applicable to gathering similar information about bicycles. These include automatic (machine) counting, manual counting, and video taping or taking motion pictures.

Very little information is available on the use of automatic counting devices for bicycles. None are currently on the market which can discriminate between bicycles and motor vehicles or bicycles and pedestrians in a multi-usage situation. The Oregon State Highway Division used magnetic loop detectors with limited success to count bicycles because of the high level of vandalism (3). Mechanical means of counting provide accurate directional flow, peak hour identification, and total volume, when all the bicycles can be channeled past the device, but can not count the intersection turning movements.

Manual counts can provide the additional data regarding the amount of intersection movements plus the observations of how the maneuvers were performed. This information can be further amplified and recorded by using video tape equipment or by taking motion pictures of the roadway area being observed. However, both camera and manual counting methods are costly, and unless high volumes of bicycle traffic or complex intersection problems exist, may not warrant consideration.

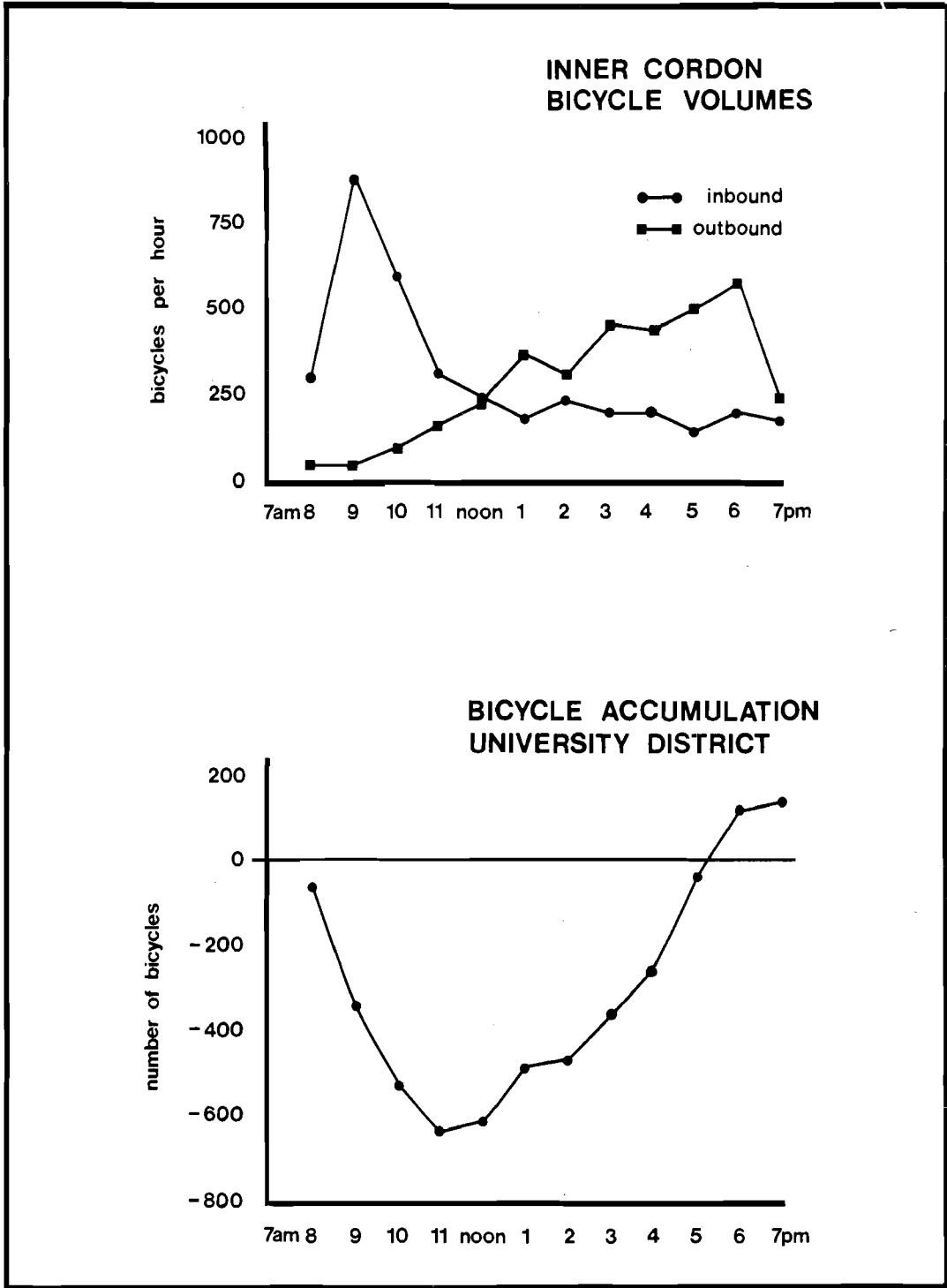

FIGURE III-2 BICYCLE VOLUME CURVES
 SOURCE : City of Seattle, Bicycle Safety Study

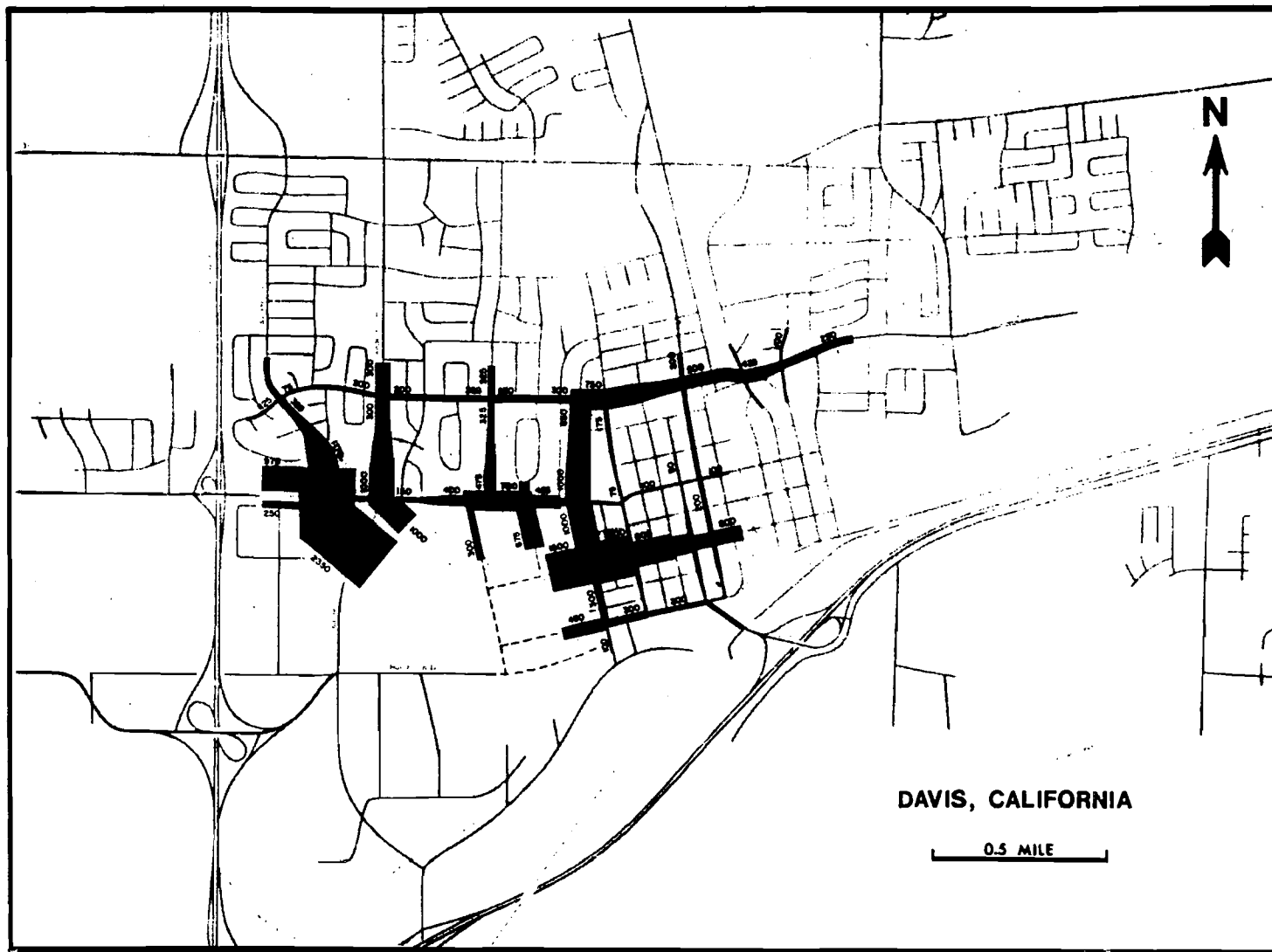

Figure III-3 BICYCLE FLOW MAP

SOURCE: Deleuw, Cather & Co., Davis Circulation & Safety Study

"Blank Map" Survey

The "Blank Map" survey technique provides a method of obtaining quick and reasonably accurate information on bicycle trip routes to and from an activity center. It was first used by the City of Seattle on the University of Washington's campus in late 1972.

To conduct a "Blank Map" survey, blank maps showing only the street system outline are provided on which the route path is marked by the bicyclist using color coding to differentiate between in-bound and out-bound trips. In order to alleviate possible difficulty in reading the map, it should be of a large size with all streets identified. Survey stations should be located to intercept the bicycle operators enroute or, preferably, at the termination of their trip. The survey station operator should be knowledgeable of the street system in order to aid the respondents. Each map can be marked with a large number of trips but should be replaced with a clean map before its information becomes confusing to the survey attendant. The number of trips using a common route must be maintained on each map to provide the necessary data on bicycle traffic volumes. The bicycle volumes and route paths from all maps are aggregated at the conclusion of the survey and, through use of expansion factors, can be presented as a bicycle traffic flow map. The principal benefit of this technique is the identification of high use routes and corridors. This information is especially useful when considering the possible "reassignment" of bicycle trips resulting from the installation of a bikeway.

One advantage of this planning tool is that it is not totally dependent on contacting the bicycle users during their trip, and thus has a degree of freedom from the vagaries of the weather. For example, an entire small city or a portion of a large city could be polled by mailing blank maps to all the residences in the area or by having a map printed in the local newspaper. More direct contact can be achieved with bicycle operators, through bicycle clubs, at retail bicycle shops, and through the school system.

It is important that the number of persons surveyed be a substantial sample of the bicycle users going to the activity center. The total bicycle volume will have been established either by a cordon count or an estimate. If the area of the activity center is large, i.e. central business district, university campus, etc., the survey stations should be located to minimize bias in the results.

As with all bicycle survey methods involving personal contact with the respondents, additional information can be obtained beyond the confines of the principal goal. Questions regarding accident frequency, years of bicycling, age, and other pertinent data can be requested. The supplementary survey is especially valuable in maintaining interest when a large number of bicycle operators are waiting to mark the map.

Origin-Destination Survey

The bicycle origin-destination survey is "conducted to obtain data on geographic travel patterns in an area." (4). This information identifies the bicycle operator's present trip origins and destinations and can be expanded to include questions regarding trip purpose,

and time-of-day and day-of-week when the trips are made. Although this information is analogous to that acquired in the "blank map" technique, no attempt is made to define the actual routes taken.

All of the individual origins and destinations can be aggregated and shown on a map as a scattering of trips throughout the entire area (Figure III-4) or be separated by destination into star-burst patterns (Figure III-5). "Desire lines" are drawn between each origin and its destination, or from the center of an origin zone to the center of a destination zone in areas of high bicycle usage. The width of the desire line is drawn proportional to the number of trips between the two points.

The O-D survey can be included as a part of any of the survey methods of this chapter including that of the following section, User Characteristic Surveys. However, when combining data collection operations, care must be exercised that the principal objective for each survey is attained. An O-D survey combined with a cordon count, for example, would be an economical method of obtaining a sizable amount of important data. If the numbers of bicycle operators being polled for origin and destination information were so great that an accurate volume count could not be maintained, the value of the cordon count would be jeopardized.

An origin-destination survey can be utilized to forecast future bicycling demands in an area. The present star-burst pattern attracted to an activity center can be superimposed on a dot map representing potential users. Using the experience drawn from other communities on bicycle use increase due to bikeway installation, or based on local knowledge gained from a demonstration bikeway program (see Chapter 4), estimates can be made on future bicycle volume.

Forecasts of the magnitude of future bicycle use and the direction of travel are very useful in the prediction of bicycle/motor vehicle conflicts in an area and in the demand for bicycle parking facilities at an activity center.

USER CHARACTERISTIC SURVEYS

"Just as in the rational design of any system involving humans, the design of bikeways must consider human factors if the system is to effectively operate and generate additional users in the future" (5). In order to design a system in a rational fashion, methods must be employed to determine which factors are important and how to utilize them in creating a safer bicycling environment. Four data collection techniques have been used to identify today's bicyclists and how they function. They are: bicycle operator questionnaires, review of bicycle/motor vehicle accident information, retail bicycle sales surveys, and bicycle operator observation.

The Bicycle Operator Questionnaire

The Bicycle Operator Questionnaire is used to gather information directly from the bicyclist. In form it closely resembles some of the

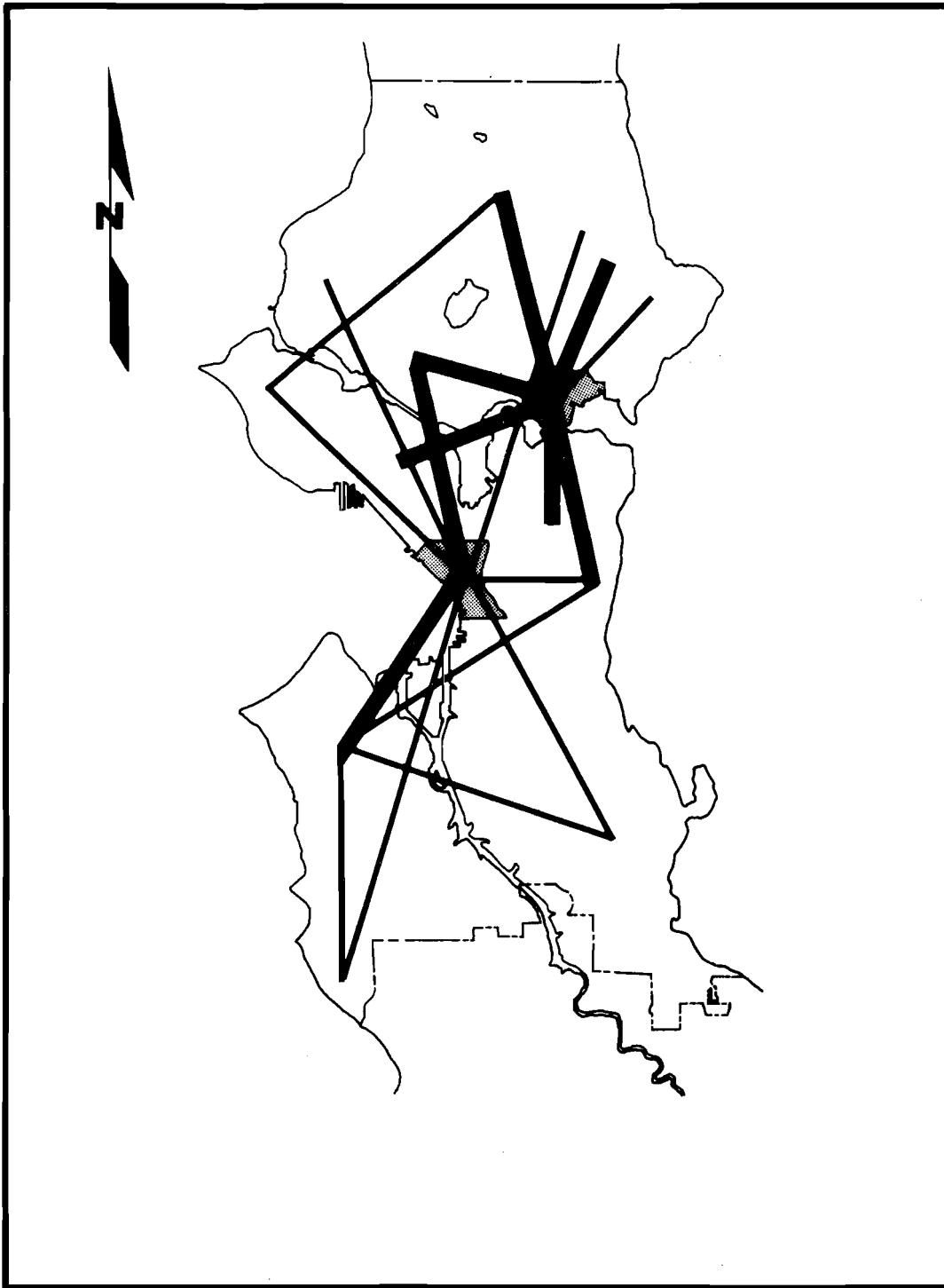

Figure III-4 HYPOTHETICAL DESIRE LINE DIAGRAM

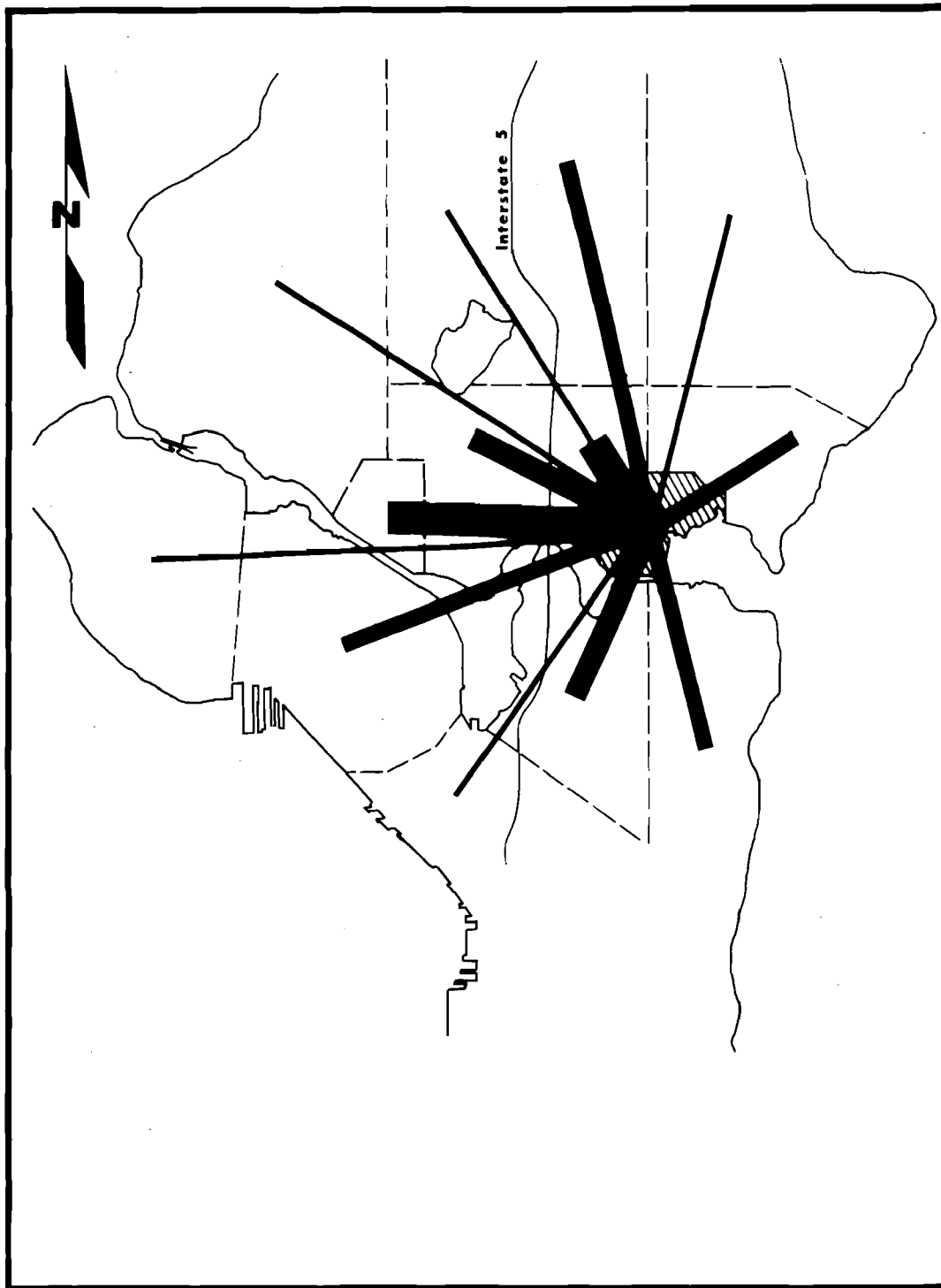

Figure III-5 HYPOTHETICAL "STAR BURST" PATTERN

Travel Surveys of the preceding section and, at times, is incorporated into that data collection process. However, the principal objectives of this survey of bicycle users are to better define who are today's bicyclists, the trip purposes for which they choose the bicycle mode, their attitudes toward existing conditions and proposed changes, and to measure their behavior under present and future conditions. Figure III-6 and III-7 are examples of a Bicycle Operators Questionnaire.

In addition, demographic information regarding the bicyclist's household can be obtained at the same time (Part I, Figure III-6).

A city lacking an effective bicycle registration program can, through the use of household locations and other indicators (i.e. income, family size, number of automobiles, etc.), gain an understanding of the dispersion of bicyclists throughout the community and the social milieu from which they come. Comparisons can be made with census data for the general population or by census tract.

The Bicycle Operator Questionnaire can be distributed using the same methods noted in the preceding Household Survey section. Attention should be given to selecting the technique which will provide the maximum usable information at the lowest cost. If a large return is anticipated the questionnaire format should be arranged to minimize the editing task and to allow direct computer card key-punching.

Bicycle/Motor Vehicle Accident Data

All communities have information available pertaining to recorded bicycle/ motor vehicle accidents; some are also able to review doctor and hospital bicyclist accident records. A study of this data may present an insight into bicyclists' behavior not generally recognized in a summary of accident statistics. For example, a study of individual accident investigation forms in Seattle, Washington, (6) identified a high frequency of collisions between motor vehicles and bicyclists riding downhill. Often in these cases the motorists claimed that the bicycle was not visible. Much study is still necessary to develop the proper accident reduction counter-measures for this type of collision. However, the detailed information developed through an in-depth accident review adds pertinent data to the full spectrum of user characteristics.

Retail Bicycle Sales Information

Local retail bicycle sales information can provide an indication of future bicycle usage trends and the types of bicycles to be used. In addition, the types of bicycles sold and the age of the intended users can be correlated with accident data and the responses from operator questionnaire to predict expected bicyclist behavior.

A questionnaire similar to Figure III-8 can be used to obtain the desired information. It is important that the retail establishments be fully advised, by letter or in person, why the documentation is needed and how the accumulated information will be applied.

FIGURE III-6 BICYCLE OPERATOR QUESTIONNAIRE
 SOURCE: City of Seattle, Bicycle Safety Study

Bicycle Riders Questionnaire

No. 9205

Your answers to the following questions will aid the City of Seattle in learning more about bicycle riders so we can work toward making our streets safer for both bicyclists and motorists. Your answers are important to the success of the survey, so *please return the questionnaire even if you choose to omit some items.*

Part I

TO BE ANSWERED ONLY BY HEAD OF HOUSEHOLD

(To be filled in by NON-BICYCLE RIDERS also)

NOTE: Single persons living with non-relatives, in rooming houses, co-operatives, etc., have a household size of one.

1. Number of persons in household _____
2. Number of automobiles at household _____
3. Enter the number of bicycles by type at household
 - One speed _____
 - Three speed _____
 - Ten speed _____
 - Other (specify) _____
4. What is address of household (actual address or hundred block, for example, 3100 S. Graham Street, 10400 Interlake Avenue N., etc.)?

5. What is your age? _____
6. What is your sex?
 - Male _____
 - Female _____
7. What was the total combined income of all members of your household last year?

<input type="checkbox"/> Less than \$4,000	<input type="checkbox"/> \$6,000 - \$7,999	<input type="checkbox"/> \$15,000 - \$25,000
<input type="checkbox"/> \$4,000 - \$5,999	<input type="checkbox"/> \$8,000 - \$9,999	<input type="checkbox"/> Over \$25,000
	<input type="checkbox"/> \$10,000 - \$14,999	

Part II

TO BE ANSWERED BY BICYCLISTS IN HOUSEHOLD

- | | | | | | |
|---------------------------------------------------------------------------------------------------------------------------------------------|-----------------------|--------------------------|--------------------------|--------------------------|--------------------------|
| | | RIDER #1 | RIDER #2 | RIDER #3 | RIDER #4 |
| 1. How "safe" do you feel it is to bicycle on Seattle's streets? | Very safe | <input type="checkbox"/> | <input type="checkbox"/> | <input type="checkbox"/> | <input type="checkbox"/> |
| | Safe | <input type="checkbox"/> | <input type="checkbox"/> | <input type="checkbox"/> | <input type="checkbox"/> |
| | Not so safe | <input type="checkbox"/> | <input type="checkbox"/> | <input type="checkbox"/> | <input type="checkbox"/> |
| | Dangerous | <input type="checkbox"/> | <input type="checkbox"/> | <input type="checkbox"/> | <input type="checkbox"/> |
| 2. How important is the need for bicycle paths, bicycle lanes, etc. (bikeways)? | Very important | <input type="checkbox"/> | <input type="checkbox"/> | <input type="checkbox"/> | <input type="checkbox"/> |
| | Important | <input type="checkbox"/> | <input type="checkbox"/> | <input type="checkbox"/> | <input type="checkbox"/> |
| | Not important | <input type="checkbox"/> | <input type="checkbox"/> | <input type="checkbox"/> | <input type="checkbox"/> |
| | Don't know | <input type="checkbox"/> | <input type="checkbox"/> | <input type="checkbox"/> | <input type="checkbox"/> |
| 3. How much would you be willing to pay each year for a bicycle license to help build and maintain bikeways? | Nothing | <input type="checkbox"/> | <input type="checkbox"/> | <input type="checkbox"/> | <input type="checkbox"/> |
| | \$1.00 | <input type="checkbox"/> | <input type="checkbox"/> | <input type="checkbox"/> | <input type="checkbox"/> |
| | \$2.00 | <input type="checkbox"/> | <input type="checkbox"/> | <input type="checkbox"/> | <input type="checkbox"/> |
| | \$3.00 | <input type="checkbox"/> | <input type="checkbox"/> | <input type="checkbox"/> | <input type="checkbox"/> |
| | More than \$3.00 | <input type="checkbox"/> | <input type="checkbox"/> | <input type="checkbox"/> | <input type="checkbox"/> |
| 4. If a bikeway is available to your destination, how far would you go out of your way to get on it? (A typical city block is 300 ft. long) | 0 Blocks | <input type="checkbox"/> | <input type="checkbox"/> | <input type="checkbox"/> | <input type="checkbox"/> |
| | 1 Block | <input type="checkbox"/> | <input type="checkbox"/> | <input type="checkbox"/> | <input type="checkbox"/> |
| | 2 Blocks | <input type="checkbox"/> | <input type="checkbox"/> | <input type="checkbox"/> | <input type="checkbox"/> |
| | 3 Blocks | <input type="checkbox"/> | <input type="checkbox"/> | <input type="checkbox"/> | <input type="checkbox"/> |
| a. If you were going one mile | More than 3 | <input type="checkbox"/> | <input type="checkbox"/> | <input type="checkbox"/> | <input type="checkbox"/> |
| b. If you were going two miles | 0 Blocks | <input type="checkbox"/> | <input type="checkbox"/> | <input type="checkbox"/> | <input type="checkbox"/> |
| | 1 Block | <input type="checkbox"/> | <input type="checkbox"/> | <input type="checkbox"/> | <input type="checkbox"/> |
| | 2 Blocks | <input type="checkbox"/> | <input type="checkbox"/> | <input type="checkbox"/> | <input type="checkbox"/> |
| | 3 Blocks | <input type="checkbox"/> | <input type="checkbox"/> | <input type="checkbox"/> | <input type="checkbox"/> |
| | More than 3 | <input type="checkbox"/> | <input type="checkbox"/> | <input type="checkbox"/> | <input type="checkbox"/> |
| c. If you were going three or more miles | 0 Blocks | <input type="checkbox"/> | <input type="checkbox"/> | <input type="checkbox"/> | <input type="checkbox"/> |
| | 1 Block | <input type="checkbox"/> | <input type="checkbox"/> | <input type="checkbox"/> | <input type="checkbox"/> |
| | 2 Blocks | <input type="checkbox"/> | <input type="checkbox"/> | <input type="checkbox"/> | <input type="checkbox"/> |
| | 3 Blocks | <input type="checkbox"/> | <input type="checkbox"/> | <input type="checkbox"/> | <input type="checkbox"/> |
| | More than 3 | <input type="checkbox"/> | <input type="checkbox"/> | <input type="checkbox"/> | <input type="checkbox"/> |
| 5. What do you estimate is the number of miles you rode during 1973? | | <input type="checkbox"/> | <input type="checkbox"/> | <input type="checkbox"/> | <input type="checkbox"/> |
| 6. Why do you ride a bicycle? (number in order of importance: 1 most important, 2 less important, etc.) | Exercise | <input type="checkbox"/> | <input type="checkbox"/> | <input type="checkbox"/> | <input type="checkbox"/> |
| | Fun/recreation | <input type="checkbox"/> | <input type="checkbox"/> | <input type="checkbox"/> | <input type="checkbox"/> |
| | Shopping | <input type="checkbox"/> | <input type="checkbox"/> | <input type="checkbox"/> | <input type="checkbox"/> |
| | Travel to | <input type="checkbox"/> | <input type="checkbox"/> | <input type="checkbox"/> | <input type="checkbox"/> |
| | School | <input type="checkbox"/> | <input type="checkbox"/> | <input type="checkbox"/> | <input type="checkbox"/> |
| | Travel to work | <input type="checkbox"/> | <input type="checkbox"/> | <input type="checkbox"/> | <input type="checkbox"/> |
| | Environmental Reasons | <input type="checkbox"/> | <input type="checkbox"/> | <input type="checkbox"/> | <input type="checkbox"/> |

CONTINUED ON THE BACK

7. How often during the week do you ride your bike in Seattle?

a. In Summer	Daily (7 days)	<input type="checkbox"/>	<input type="checkbox"/>	<input type="checkbox"/>	<input type="checkbox"/>	<input type="checkbox"/>	<input type="checkbox"/>	<input type="checkbox"/>	<input type="checkbox"/>
	Often (4-6 days)	<input type="checkbox"/>	<input type="checkbox"/>	<input type="checkbox"/>	<input type="checkbox"/>	<input type="checkbox"/>	<input type="checkbox"/>	<input type="checkbox"/>	<input type="checkbox"/>
	Occasionally (1-3 days)	<input type="checkbox"/>	<input type="checkbox"/>	<input type="checkbox"/>	<input type="checkbox"/>	<input type="checkbox"/>	<input type="checkbox"/>	<input type="checkbox"/>	<input type="checkbox"/>
	Never	<input type="checkbox"/>	<input type="checkbox"/>	<input type="checkbox"/>	<input type="checkbox"/>	<input type="checkbox"/>	<input type="checkbox"/>	<input type="checkbox"/>	<input type="checkbox"/>
	Only on weekends	<input type="checkbox"/>	<input type="checkbox"/>	<input type="checkbox"/>	<input type="checkbox"/>	<input type="checkbox"/>	<input type="checkbox"/>	<input type="checkbox"/>	<input type="checkbox"/>
b. In Winter	Daily (7 days)	<input type="checkbox"/>	<input type="checkbox"/>	<input type="checkbox"/>	<input type="checkbox"/>	<input type="checkbox"/>	<input type="checkbox"/>	<input type="checkbox"/>	<input type="checkbox"/>
	Often (4-6 days)	<input type="checkbox"/>	<input type="checkbox"/>	<input type="checkbox"/>	<input type="checkbox"/>	<input type="checkbox"/>	<input type="checkbox"/>	<input type="checkbox"/>	<input type="checkbox"/>
	Occasionally (1-3 days)	<input type="checkbox"/>	<input type="checkbox"/>	<input type="checkbox"/>	<input type="checkbox"/>	<input type="checkbox"/>	<input type="checkbox"/>	<input type="checkbox"/>	<input type="checkbox"/>
	Never	<input type="checkbox"/>	<input type="checkbox"/>	<input type="checkbox"/>	<input type="checkbox"/>	<input type="checkbox"/>	<input type="checkbox"/>	<input type="checkbox"/>	<input type="checkbox"/>
	Only on weekends	<input type="checkbox"/>	<input type="checkbox"/>	<input type="checkbox"/>	<input type="checkbox"/>	<input type="checkbox"/>	<input type="checkbox"/>	<input type="checkbox"/>	<input type="checkbox"/>

8. What are your reasons for not riding your bike more often?

Fear of auto traffic	<input type="checkbox"/>	<input type="checkbox"/>	<input type="checkbox"/>	<input type="checkbox"/>	<input type="checkbox"/>
Weather	<input type="checkbox"/>	<input type="checkbox"/>	<input type="checkbox"/>	<input type="checkbox"/>	<input type="checkbox"/>
Hard work	<input type="checkbox"/>	<input type="checkbox"/>	<input type="checkbox"/>	<input type="checkbox"/>	<input type="checkbox"/>
Lack of bike storage at destination	<input type="checkbox"/>	<input type="checkbox"/>	<input type="checkbox"/>	<input type="checkbox"/>	<input type="checkbox"/>
Lack of washroom at destination	<input type="checkbox"/>	<input type="checkbox"/>	<input type="checkbox"/>	<input type="checkbox"/>	<input type="checkbox"/>
Takes too long	<input type="checkbox"/>	<input type="checkbox"/>	<input type="checkbox"/>	<input type="checkbox"/>	<input type="checkbox"/>

9. What is your age?

()	()	()	()	()
---	---	---	---	---	---	---	---	---	---

10. What is your sex? (M) or (F)

--	--	--	--	--	--	--	--	--	--

11. Indicate your most recent of number of continuous years of bike riding. (Example: A man, age 33, learned to ride a bike at 10. Three years ago he bought a bike and has ridden ever since. He would check the block 2-4 years.)

0-1 year	<input type="checkbox"/>	<input type="checkbox"/>	<input type="checkbox"/>	<input type="checkbox"/>	<input type="checkbox"/>	<input type="checkbox"/>	<input type="checkbox"/>	<input type="checkbox"/>	<input type="checkbox"/>
1-2 years	<input type="checkbox"/>	<input type="checkbox"/>	<input type="checkbox"/>	<input type="checkbox"/>	<input type="checkbox"/>	<input type="checkbox"/>	<input type="checkbox"/>	<input type="checkbox"/>	<input type="checkbox"/>
2-4 years	<input type="checkbox"/>	<input type="checkbox"/>	<input type="checkbox"/>	<input type="checkbox"/>	<input type="checkbox"/>	<input type="checkbox"/>	<input type="checkbox"/>	<input type="checkbox"/>	<input type="checkbox"/>
4-6 years	<input type="checkbox"/>	<input type="checkbox"/>	<input type="checkbox"/>	<input type="checkbox"/>	<input type="checkbox"/>	<input type="checkbox"/>	<input type="checkbox"/>	<input type="checkbox"/>	<input type="checkbox"/>
6-8 years	<input type="checkbox"/>	<input type="checkbox"/>	<input type="checkbox"/>	<input type="checkbox"/>	<input type="checkbox"/>	<input type="checkbox"/>	<input type="checkbox"/>	<input type="checkbox"/>	<input type="checkbox"/>
8-10 years	<input type="checkbox"/>	<input type="checkbox"/>	<input type="checkbox"/>	<input type="checkbox"/>	<input type="checkbox"/>	<input type="checkbox"/>	<input type="checkbox"/>	<input type="checkbox"/>	<input type="checkbox"/>
Over 10 years	<input type="checkbox"/>	<input type="checkbox"/>	<input type="checkbox"/>	<input type="checkbox"/>	<input type="checkbox"/>	<input type="checkbox"/>	<input type="checkbox"/>	<input type="checkbox"/>	<input type="checkbox"/>

12. Please add your comments about bicycling or bikeways:

THANK YOU FOR YOUR ASSISTANCE

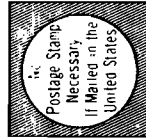

PLEASE FOLD



BUSINESS REPLY MAIL
First Class Permit No. 11065 Seattle, Wa.

BICYCLE SAFETY STUDY

**Municipal Bldg., Room 708
600 4th Avenue
Seattle, Wa. 98104**

Figure III-7 BICYCLE OPERATOR QUESTIONNAIRE
SOURCE: City of Seattle, Bicycle Safety Study

BICYCLE QUESTIONNAIRE
RETAIL SALES ESTABLISHMENTS

The information from this questionnaire is to be used for bicycle studies only. (Where exact numbers are not available, please approximate.)

1. Where is your store(s) located (address or community)?

2. What is your position with this establishment?

Owner _____
Manager _____
Department Head _____
Salesperson _____
Other _____ (Please specify)

3. How many bicycles did your store sell in

1970 _____
1971 _____
1972 _____
First six months 1973 _____
Estimate for 1974 _____

4. How do you estimate your yearly sales trend will be for the next five years?

Raising _____ Constant _____ Dropping _____ Five Year Total _____ (1974 to 1979)

5. What percentage of bicycles sold are in the following cost categories?

Under \$100 _____
\$100-\$150 _____
Over \$150 _____

6. What percentage of bicycles sold are in the following type categories?

10 speed _____
5 speed _____
3 speed _____
1 speed _____
Other _____

7. What was the intended user's age group (percentage)?

Under 15 years _____
16-25 years _____
26-40 years _____
Over 40 years _____

Please contact Bob Theisen, Traffic and Transportation Division, 583-2925 with questions regarding this study.

Figure III-8 RETAIL SALES QUESTIONNAIRE
SOURCE: City of Seattle, Bicycle Safety Study

Bicycle Operator Observations

The study of bicycle operators' actions during their trips provides an additional means of collecting information on user characteristics. This pragmatic approach permits comparisons to be made between actual behavior and that expressed in a questionnaire survey. Unsafe, indiscreet, or illegal bicycle maneuvers, revealed in an accident review, can also be easily recognized. Information regarding bicyclists behavior can often be gained only through direct observation.

The observer should be positioned to see the entire maneuver and near enough to be able to notice detailed actions. The observed actions can be committed to memory by the watcher or, better still, diagrammed. It is important that the person watching be a bicyclist or be very familiar with the demands of bicycle operation. Figure III-9 shows a generalized diagram of a left turn bicycle movement in an intersection.

Where the bicycle volume and complexity of movements is large, video taping the action or recording it on movie film may be warranted. In this case the trained observer is freed from the work at the street site and can investigate the action when needed. These techniques also permit a much greater depth of study than can be accomplished in the field. However, activities beyond the camera's view which have an impact on the bicyclists behavior are lost.

The Bicycle Operator Observations expand the scope of investigation beyond that of a simple User Characteristic Survey. It is impossible to isolate the actions of the bicycle operator, in an urban surrounding, from others living and functioning in the community. The pedestrians, operators of automobiles and commercial vehicles, dogs, and a myriad of other things, have an effect on the decisions of the bicyclists and, thus on the resulting behavior. This data collection technique provides an effective method for identifying bicycling 'cause and effect' information.

TRANSPORTATION NETWORK INVENTORY

An inventory of the entire transportation network within the urban area is needed to assure that a proposed bikeway system can be integrated into the total system with the least disruption. Because of the bicyclists predilection to often operate in conjunction with pedestrians, e.g. on sidewalks, along park paths, and on marked cross-walks, data on pedestrians should be acquired. In addition, the entire roadway system should be defined on a map with all streets classified by type, surface characteristics and legal jurisdiction. (This information may be beneficial when the funding for a bikeway is being considered). Similar network information should be gathered regarding mass transportation facilities in the community. The location of each bus line, subway-elevated line, commuter railroad line and their major transfer points and terminals should be noted. Cities with ferry boat connections should also show the terminal placements.

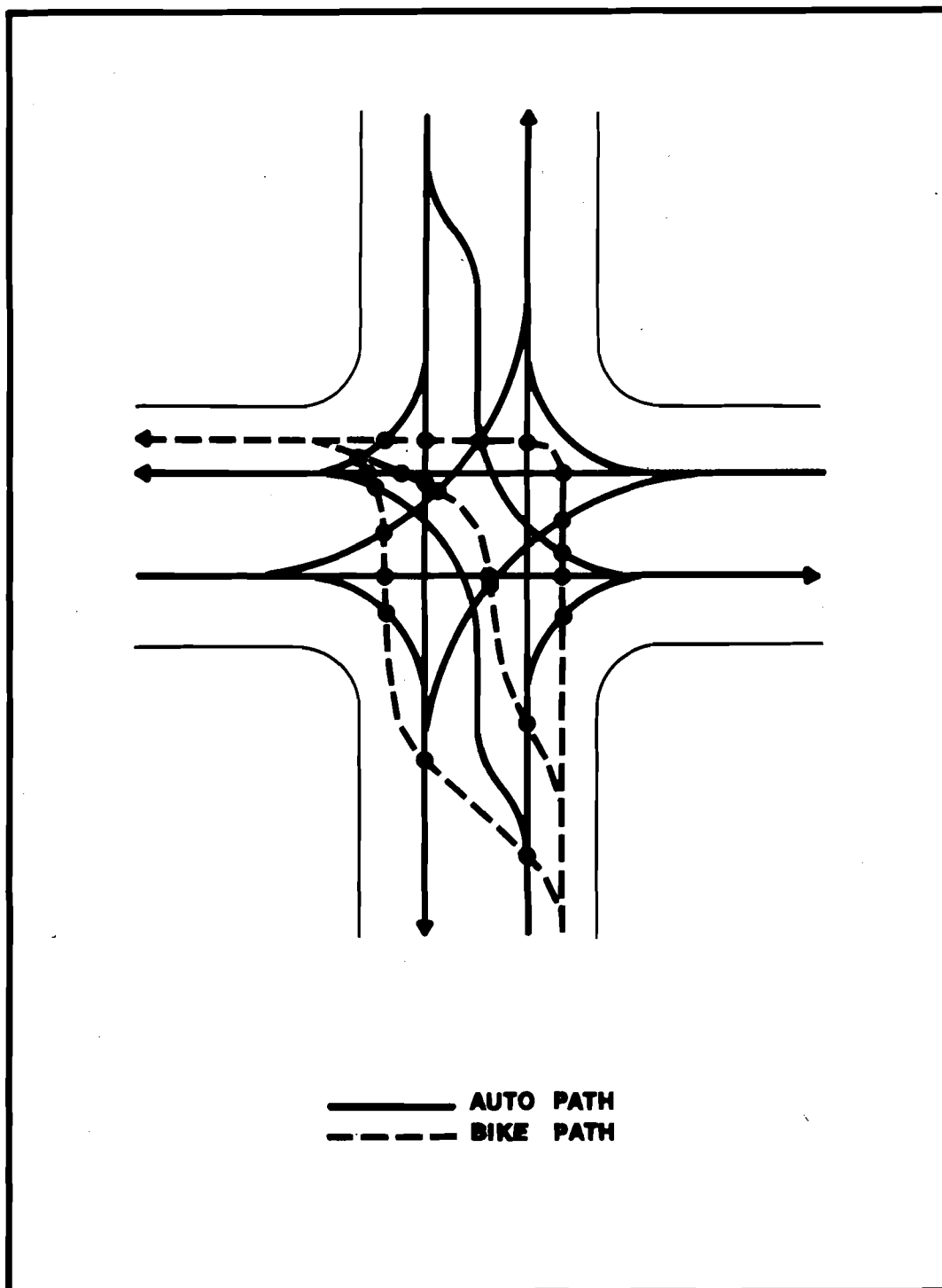

Figure III-9 TYPICAL LEGAL/ILLEGAL BICYCLE LEFT TURN MANEUVERS

SOURCE: Deleuw, Cather & Co., Davis Bicycle Circulation & Safety Study

A motor vehicle traffic volume flow map, like Figure III-10, will also assist in the development of a bikeway system.

URBAN STRUCTURE INVENTORY

The term Urban Structure is used to designate the man-made and natural arrangement of a city that encourages and constrains the use of bicycles. The inventory is made to document the location of bicycle trip attractors, generators and physical impediments. It provides the framework upon which the bikeway system is developed. It is also used as a means of graphically presenting much of the collected data.

The Urban Structure Inventory includes the definition of the residential, manufacturing and commercial areas of the community and identification of the socio-economic arrangement of the population. Additionally, the location of trip attractors like recreational activity centers, schools and universities, and public buildings such as libraries and museums, should be specified. In cities where the topography may have a restraining effect on the frequency of bicycling or tend to direct the bicycle volumes along prescribed paths, contour maps should be gathered and roadway grades noted. Legal and physical constraints to bicycle travel, such as limited access highways, bridges, tunnels, unsurfaced roadways, should be indicated. Location of physical amenities which encourage bicycle trip making, such as safe bicycle parking facilities, are also essential to a complete inventory.

Although all of this data can be presented in tabular form, graphical representation will be more descriptive and meaningful. Overlays of selected data, superposed on a base map of the city and its existing transportation systems, provides a sensitive mechanism for urban study. This tool allows the bikeway planner to present much of the collected data to city officials and the public in a easily understood fashion.

BICYCLE TRIP GENERATION FORECASTS

The preceding sections tell how to gather data and what is needed to better define the bicyclists and the urban environment in which they operate. In addition, projections of the magnitude of bicyclists which will use a complete bikeway system or a specific bikeway route are often needed. To date, very little work has been done to assist in bicycle volume forecasting. The following two methods have not been tested operationally but can provide useful approximations of future bicycle use. They are presented here as indicators of a developing state of the art and, presumably through examination and evaluation, will supply the initial basis for future refinement.

A System Bicycle Volume Analysis

In his paper, Estimating Potential Bicycle Use and Public Investment (7), Carl E. Ohrn theorized that a percentage of the total purposeful

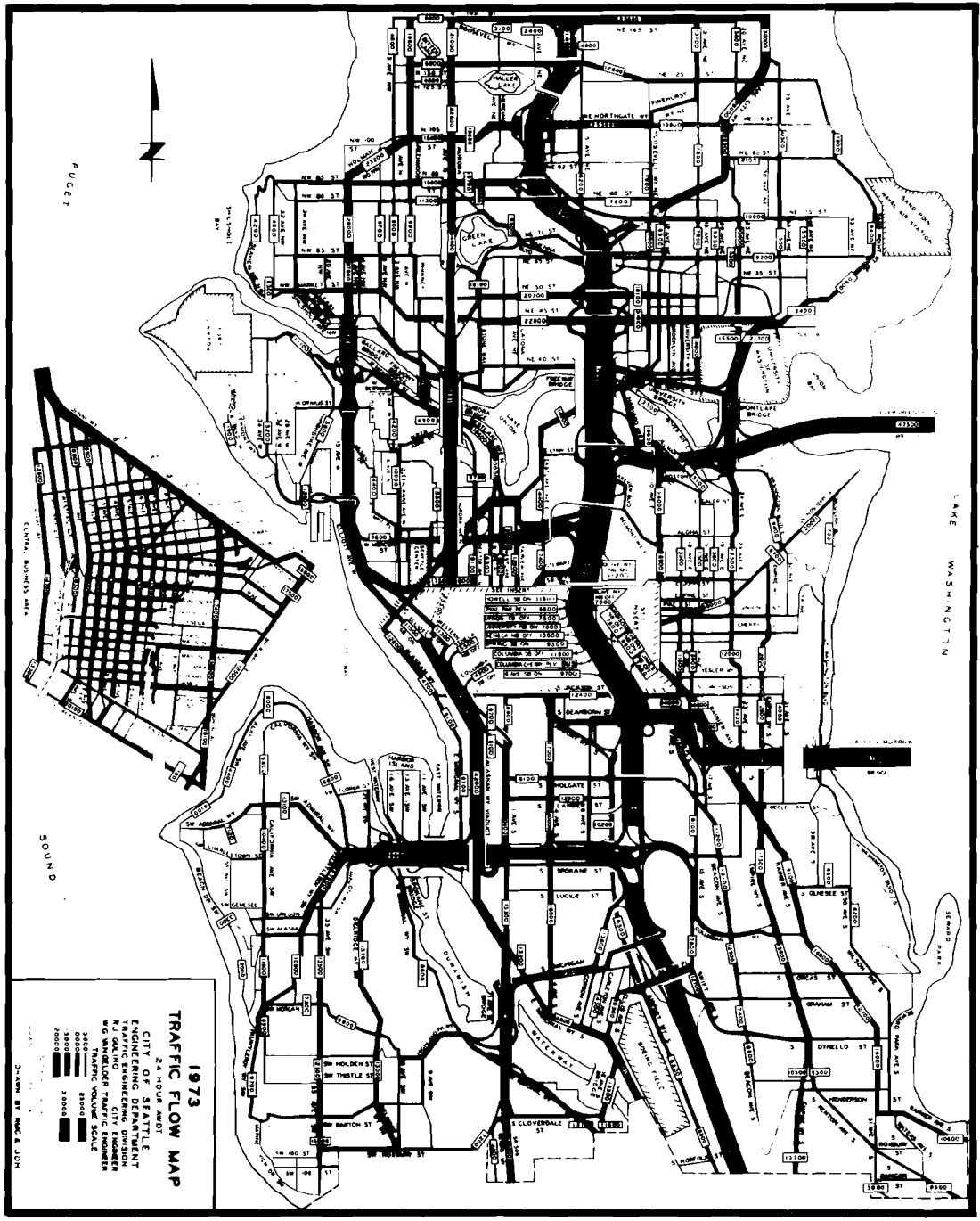

Figure III-10 MOTOR VEHICLE TRAFFIC FLOW MAP
Seattle, Washington

trips within a community could be diverted to the bicycle mode given development of a comprehensive bikeway system. Purposeful trips were defined as "those that are made to a specific destination to allow the participant to undertake some activity" (8) and excluded trips made solely for exercise and sightseeing.

The bikeway system chosen for the model city - the Twin Cities of Minneapolis and St. Paul, Minnesota - was a grid arrangement with one mile spacing in the core area and one and a half mile spacing in the suburban area. Approximately 1850 miles of separated or protected bikeway facilities were included within the bikeway system concept.

Using graphs from a motor vehicle Travel Behavior Inventory (Figure III-11) and postulating that all bicycle trips generated by the bikeway system will come from within a two mile trip distance, the percent of total daily automobile trips which were of less than six minutes duration was obtained. A subjectively developed factor for each trip purpose was applied to the number of trips thus obtained to determine how many would chose the bicycle mode (Figure III-12). The total number of daily bicycle trips predicted for the community allowed computations to be made using a "benefit value" per trip. This resulted in a "justified" annual appropriation level for bikeway system implementation.

A Bikeway Volume Projection

In Seattle, Washington an approach was used to predict the volume of bicycles at a specific point along a bikeway under development. This information was needed to determine if the bicycle volumes generated by the completed bikeway, at an intersection with a major arterial, warranted signalization. The method used was essentially one of making a direct comparison between an existing and a projected bikeway.

Demonstration Bikeway One (Figure III-13) was completed in August, 1973 and is heavily used during weekdays by students traveling between their residences and the University of Washington campus. It passes under Interstate Highway 5, about mid-point along the bikeway. The highway is elevated above the street system in this area and creates an effective barrier to east-west travel.

Bicycle counts have been made at points along the bikeway, and peak period and full day volume information assembled. One of the counting station locations was at the underpass "channel" at I-5.

A survey of bicycling students had found that the average commuter trip length was about three miles. The bikeway service area was defined using this information to establish the extreme limit. The knowledge of the topographic, street, and highway constraints to convenient bicycle travel in the general area, set the rest of the boundary. A count of students residing within the service area was made from a Student Residency Location Dot Map (9).

A service area was likewise specified for the future bikeway, the Burke-Gilman Trail, using the three mile trip limit and topographical

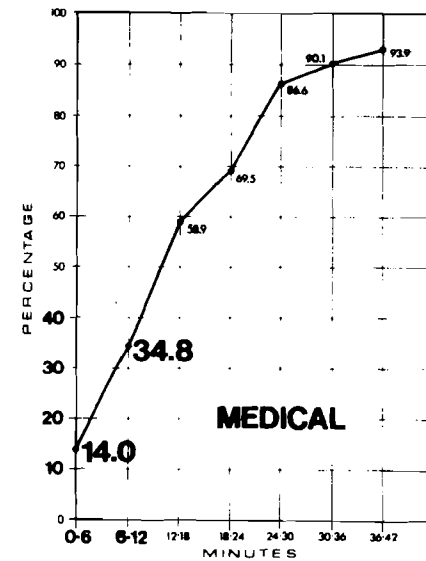
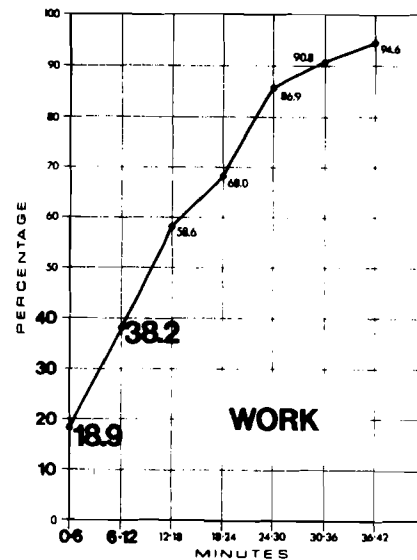
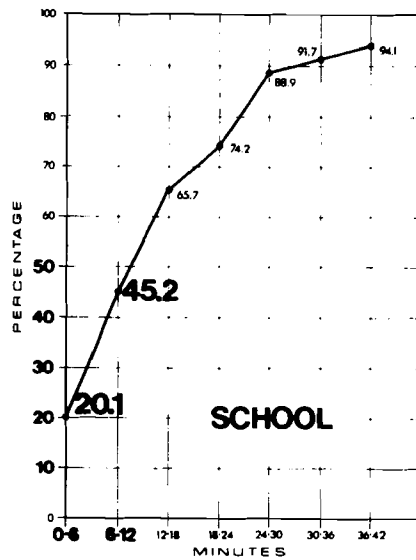
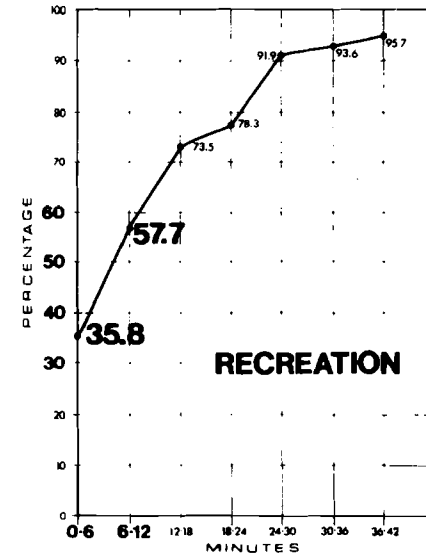
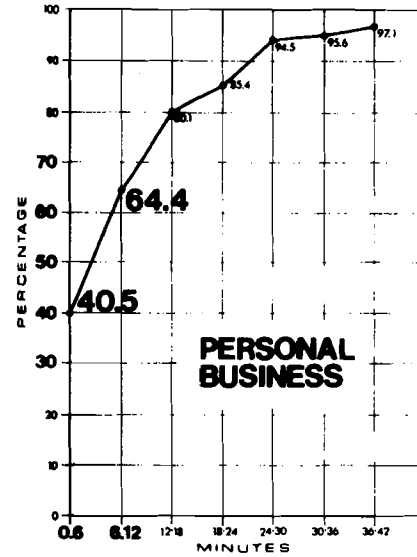
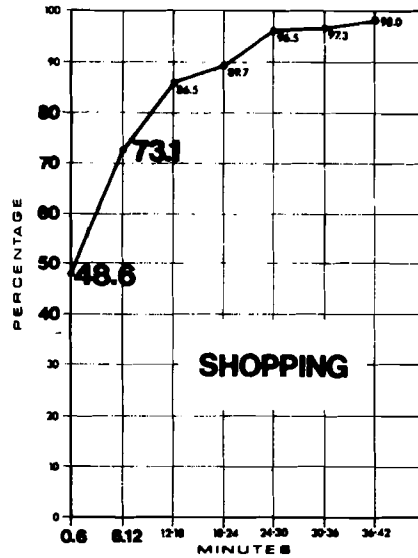

Figure III-11 TRAVEL BEHAVIOR INVENTORY

SOURCE: Barton-Aschman Assoc., Planning for Improved Bicycle Systems

Table 4
VEHICULAR TRIPS THAT CAN BE ATTRACTED TO THE BICYCLE AS THE PRIMARY MODE

Trip Purpose	Percentage of Vehicular Trips Less Than Six Minutes in Duration	Total Number of Daily Home-based Vehicular Trips	Number of Vehicular Trips That Take Six Minutes or less to Complete	Percentage of Trips Six Minutes or Less in Duration That Will Be Made by Bicycle	Number of Vehicular Trips That Would Be Attracted to Bicycle Use if Proper Facilities Were Provided
School	20.1%	160,445	32,249	50%	16,124
Personal Business	40.5%	665,580	269,560	30%	80,868
Recreation	35.0% (approximation)	817,175	286,011	30%	85,803
Shopping	48.6%	565,809	274,983	20%	54,997
Work	18.9%	829,292	156,736	5%	7,837
Medical	14.0%	47,914	6,708	5%	335
Total					247,964

Figure III-12 BICYCLE TRIP ATTRACTION

SOURCE: Barton-Aschman Assoc., Planning for Improved Bicycle Systems

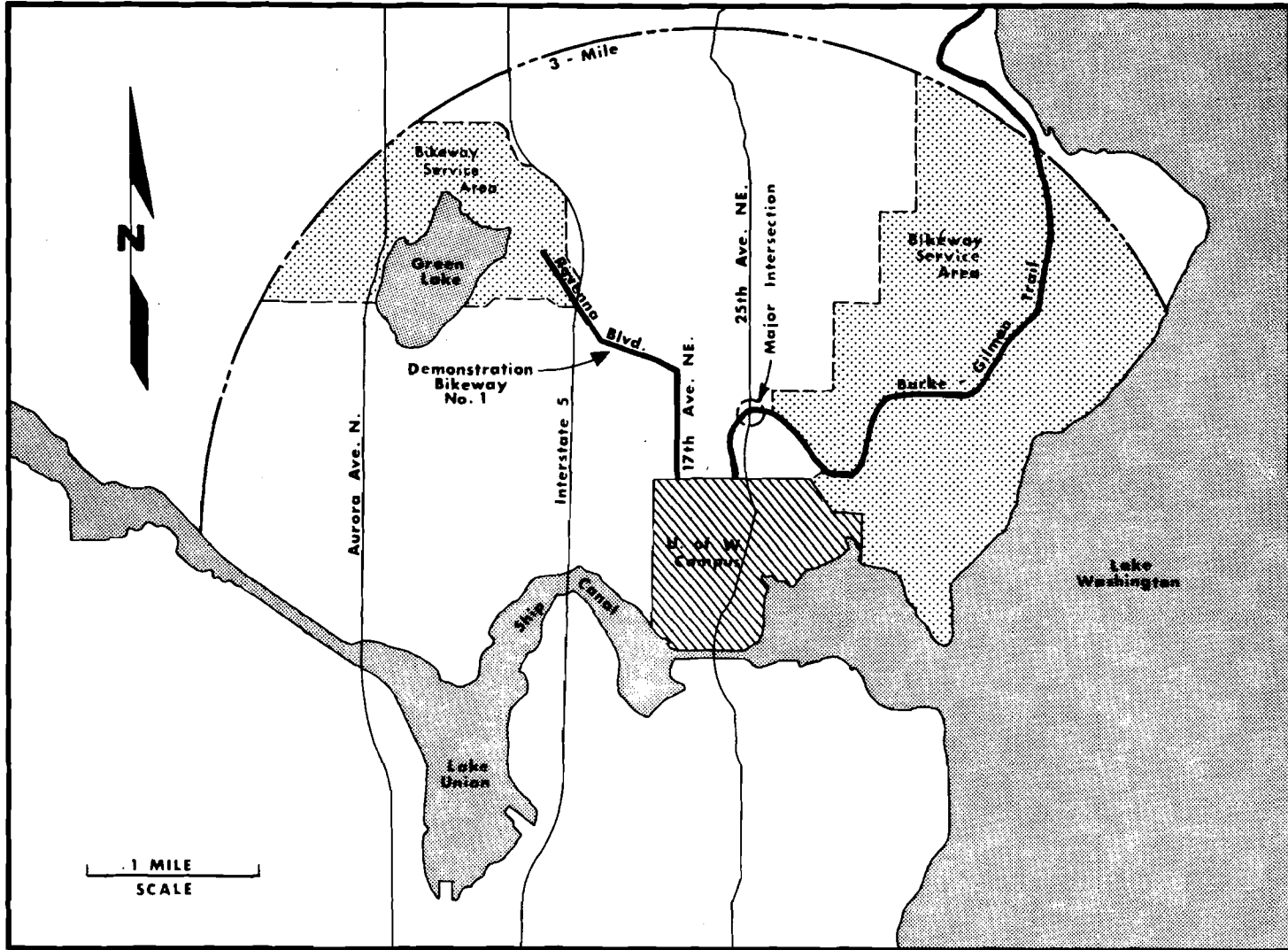

Figure III-13 BIKWAY SERVICE AREAS

and street arrangement constraints to define the area. The number of students within this area was determined.

Certain assumptions were made to permit the predictive calculations to have usefulness: 1) All inbound bicycles counted on Demonstration Bikeway One between 8:00a.m. and 9:30 a.m. were presumed to be University of Washington students; 2) the characteristics of the students living in one area were common to those in the other (especially their propensity for using bicycles to travel to the campus); and 3) the new bicycle facility would generate an immediate travel mode and route shift.

The procedure for arriving at the predicted number of bicycles crossing 25th Avenue N.E. inbound between the hours of 8:00a.m. and 9:30 a.m. can be stated thus:

$$\frac{V_1}{P_1} = \frac{V_2}{P_2}$$

Where:

- P₁ - University of Washington student population within area serviced by Demonstration Bikeway One.
- V₁ - Volume of University bound bicycles along Demonstration Bikeway One during 8:00a.m. to 9:30 a.m. period.
- P₂ - University of Washington student population within area serviced by Burke-Gilman Trail.
- V₂ - Expected volume of inbound bicycles along the Burke-Gilman Trail during 8:00a.m. to 9:30 a.m. period.

The bicycle volume obtained through this process can be further amplified to a projected full day volume. An additional assumption that the peak period volume represents the same percentage of the full day volume on both bikeways permits this calculation to be made.

A word of explanation and caution is offered: the area referred to as the service area of Demonstration Bikeway One is only a part of the total student neighborhood which has access to this facility. Two factors would have had an effect on the accuracy of the calculations had the entire bikeway been used for comparative purposes.

First, many more decisions would have been made in establishing the boundary of the service area. At locations where topographical, or other physical considerations neither encouraged nor discouraged the bicycle operator's route choice, the probability of error in boundary selection would be large. Additionally, a study has shown that the propensity for using bicycles as the mode of transportation (at this University) decreases rapidly as the trip length becomes shorter than one and a half miles.

It should be noted, that in the one case the persons actually using the facility are physically restricted from deviating from the route without a sizeable detour. This is less true of the future bikeway. Because this facility will be elevated above the adjacent street system along sections of it and depressed below at others, the users will be "captured" for part of their journey. However, for a number of blocks east of the intersection with 25th Avenue N.E. the bikeway will be at grade. The premise that all users will continue on the bikeway rather than take the shortest route is based on a comparison between these alternatives. The bikeway is to be built on an old railroad roadbed. The grade to and from the University campus is almost level. Any other route within this corridor requires climbing steep grades. The bikeway will be isolated from motor vehicle traffic except at street crossing. Other routes are within the street system which carry very high peak hour volumes in this area.

REFERENCES (CHAPTER III)

1. Creighton, Roger L., Urban Transportation Planning, (Urbana: University of Illinois Press, 1970), p. 137.
2. Seattle, City of, Bicycle Safety Study, Seattle, May, 1975 p. 59.
3. Oregon, State of, Oregon Department of Transportation, Oregon Bikeways Progress Report, (Salem: 1973), p.41.
4. Kennedy, Norman, James H. Kell, and Wolfgang S. Homburger, Fundamentals of Traffic Engineering, Institute of Traffic and Transportation Engineering, University of California, Berkeley, 1962, p. VIII-1.
5. Institute of Transportation and Traffic Engineering, Bikeway Planning Criteria and Guidelines, University of California, (Los Angeles: April, 1972), p. 155.
6. Seattle, City of, op. cit. pp. 27-35.
7. Ohrn, Carl E., "Estimating Potential Bicycle Use and Public Investment", Planning for Improved Bicycle Systems, Barton-Aschman Associates, Inc., November, 1973, pp. 25-45.
8. Ibid., p. 27.
9. Washington, University of, Student Residency Location Dot Map, Seattle, Wa. 1973.

CHAPTER IV

**BIKEWAY SYSTEM
PLAN DEVELOPMENT**

CHAPTER IV

BIKEWAY SYSTEM PLAN DEVELOPMENT

This chapter presents a framework for converting community information into a defined bikeway plan ready for implementation. The Bikeway System Plan is, in general, a reflection of the community's desires for total bicycle facility improvements as expressed through stated goals, objectives and policies. The Plan also addresses specific community wants and needs through layout of the system network and by emphasis within the supporting text.

The Bikeway System Plan serves a number of purposes. It provides a published statement of the community's bicycle goals which will have continuity through successive City administrations. It informs the citizens of the community of the direction that is to be followed during system development. Frequently an approved comprehensive plan is a legal obligation for obtaining funds to be spent in bikeway implementation (1,2). It also provides a means for evaluating the degree of development over a period of years. Another purpose of the Plan is its use in judging whether proposed bicycle facility projects enhance system work already completed or programmed for implementation. The existence of a Bikeway System Plan additionally serves as a constant reminder to City government to include funding support for bicycle facilities in its Capital Improvement Program considerations.

The initial step in formulating the Bikeway System Plan is the collection of necessary community information to clearly define the planning parameters. Origin and destination data on existing interzonal travel, "Blank Map" definitions of specific trip routes, and answers to bicycle user questionnaires, can all aid in identifying present and future bicycle patterns. Review of recorded bicycle/motor vehicle accident locations and bicycle volume information will indicate areas for serious consideration. The response from individuals, bicycle clubs, community organizations, schools and safety groups should be solicited to assist in defining specific needed improvements and the orientation of the final plan. The information received from individuals and groups may indicate a strong desire for many minor improvements to improve the safety and convenience of bicycle travel. These should be included in the plan either as identified items within the system network or as a generalized statement in the text supporting an on-going Bicycle Spot/Safety Improvement Program. The location of constraints to convenient bicycle travel and the placement of activity centers which encourage trip making should be included in the inventory.

The Plan generally consists of two major elements: a graphic representation of the system network, and a text which elaborates on the reasoning behind the network's selection, and often includes some typical bikeway design information. All portions of the plan should reflect the bicycle recreational/transportation orientation of the community.

The bikeway network results from the synthesis of the gathered information onto a City base map. Constraints to travel, such as major highways, rivers and steep hills are shown. Locations of schools, parks, shopping centers, universities and other trip attractors are also noted. Desire lines resulting from origin and destination survey and route lines from a "Blank Map" study are combined with specific proposals from individuals and groups to begin forming a cohesive network.

At this point, a significant decision must be made. The lines making up the network must be considered as depicting bikeway corridors or indicating specific bikeway routes. A corridor can be described as a significant bicycle travel "path of interest". Some communities have envisioned corridors as being about one quarter mile wide in which a number of potential routes would be evaluated for selection as bikeways.

The corridor approach provides the community with the greatest plan flexibility. The specific bikeway design does not have to be selected until that segment of the network is to be built which permits incorporation of design innovations. It also allows the final design to reflect requirements which may be part of a funding agreement. By establishing the network segments as corridors the system is inherently responsive to changes in land use and travel patterns over time. Another important attribute is that citizen involvement can be maximized by exposing each individual project to scrutiny, rather than having the system accepted in its entirety.

On the other hand, where a community's system is small, the expected implementation time short, and the needed supporting data available, the network can describe specific bikeway routes, rather than the more generalized "corridors".

The recommended bikeway system network derived from an analysis of the gathered information will have one of the following five planforms:

1. Grid
2. Radial
3. Loop
4. Linear
5. Combination

Figure IV-1 shows the Combination planform corridor network of Seattle, Washington (3). Figures IV-2 through IV-5 illustrate the portions of the network which represent the four specific planform types.

Although Figure IV-1 shows a system which includes a full variety of planform arrangements, Figure IV-6 presents a total network which is essentially linear. Many examples of grid type networks have been included in bikeway plans from flat areas of the country.

comprehensive bikeway plan

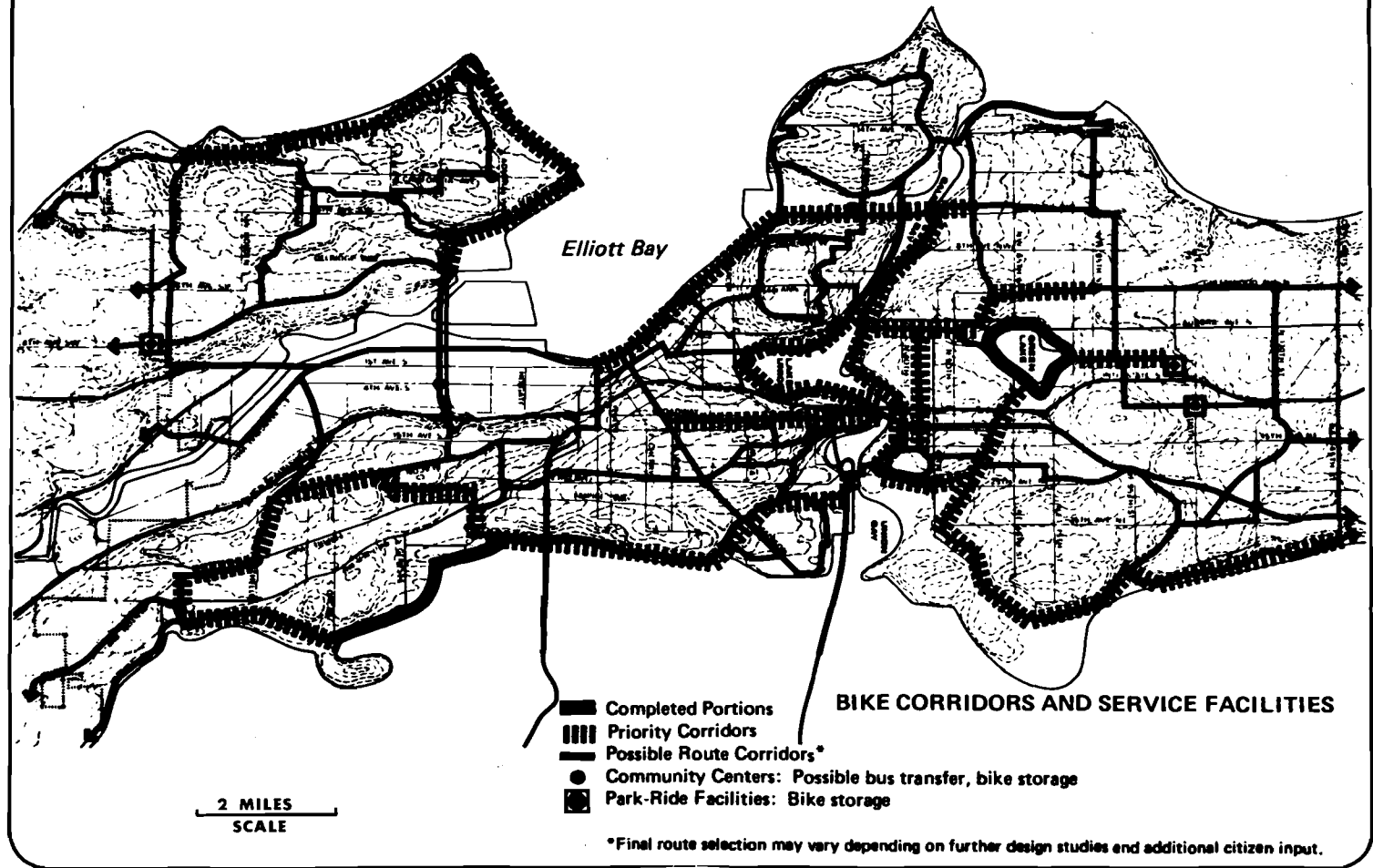
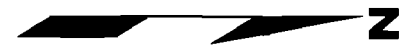
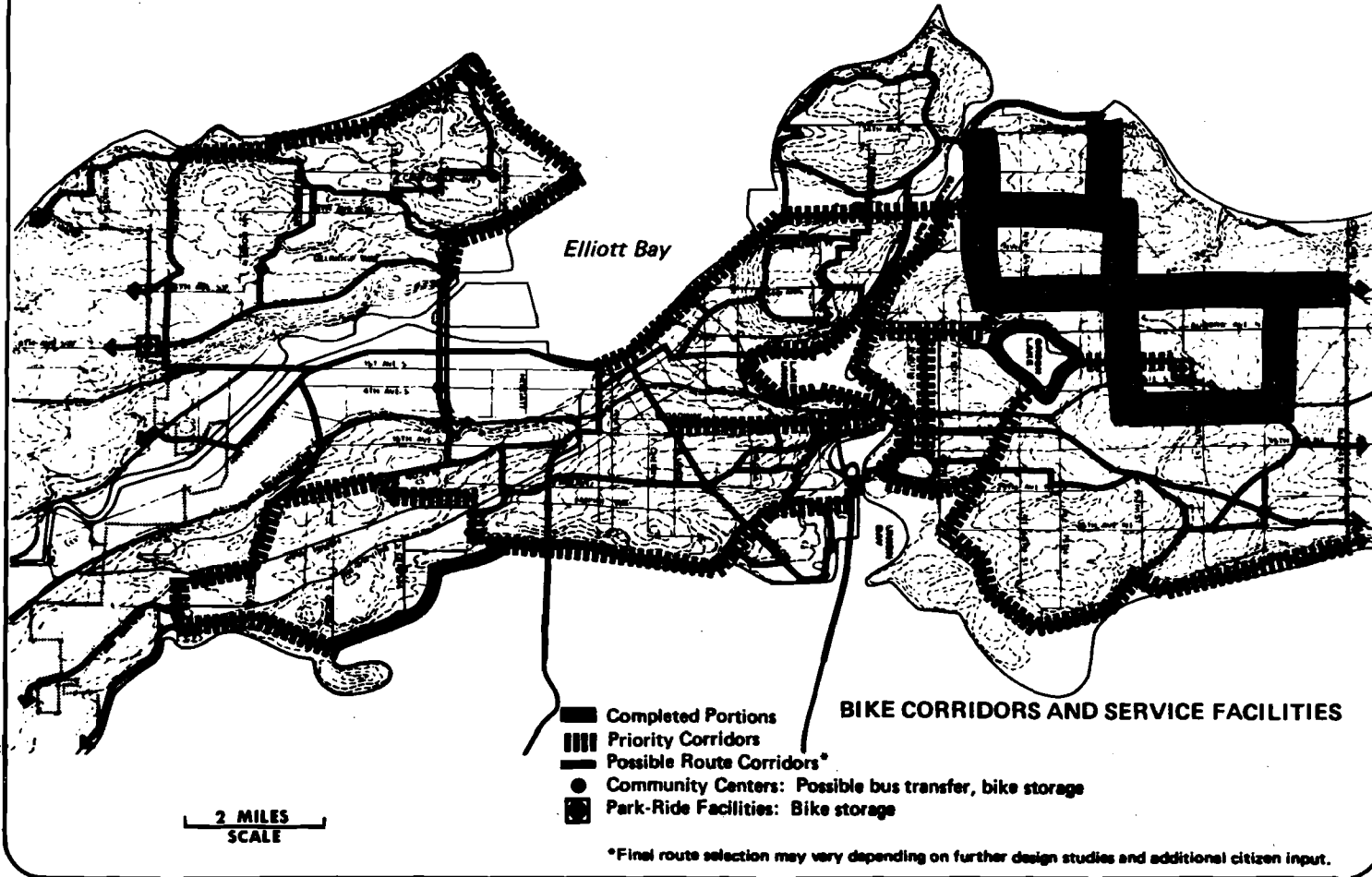
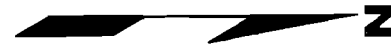

Figure IV-1 COMBINATION PLANFORM SYSTEM NETWORK

SOURCE: City of Seattle, Comprehensive Bikeway Plan

comprehensive bikeway plan



04

Figure IV-2 GRID PLANFORM

comprehensive bikeway plan

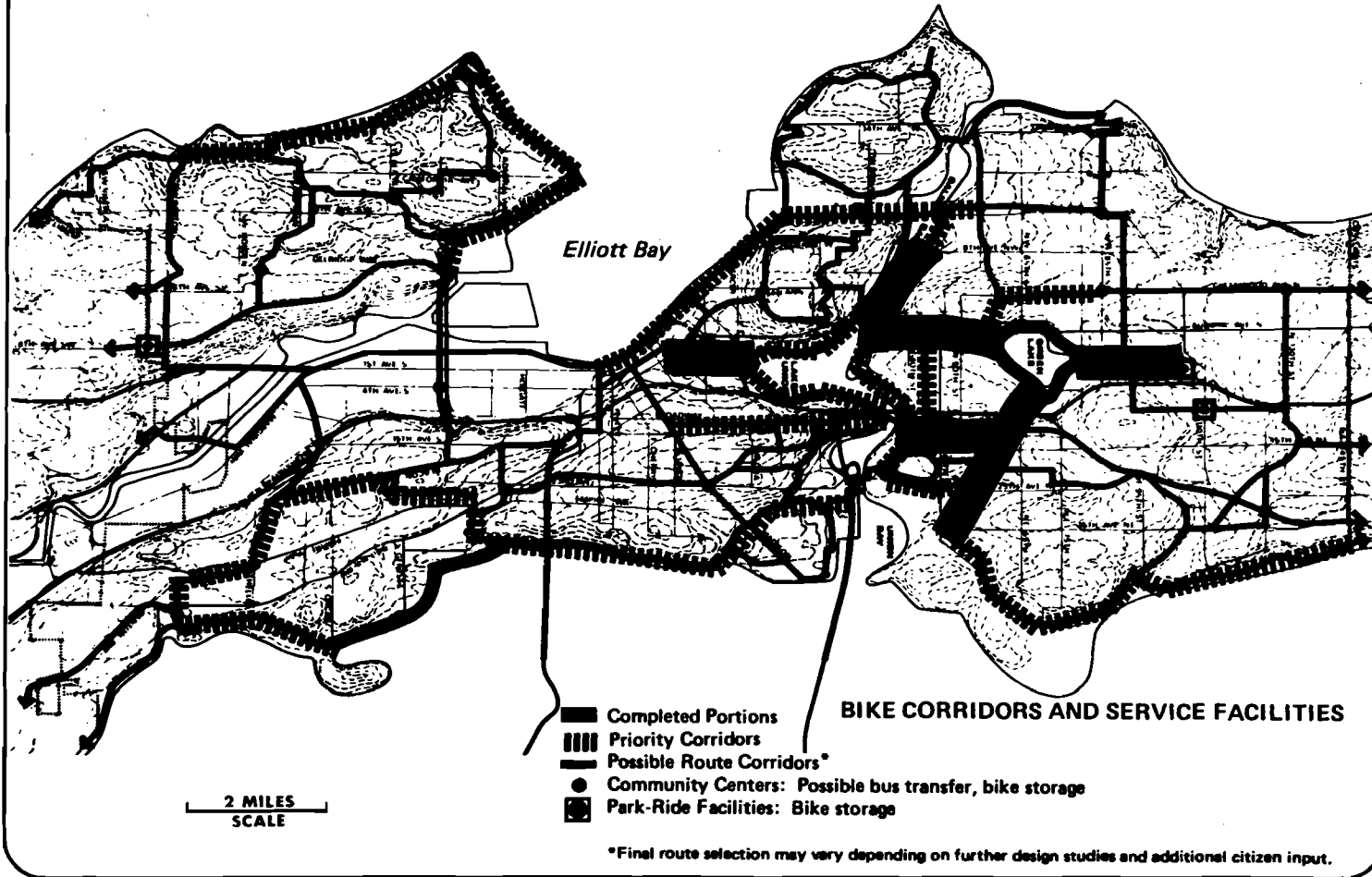
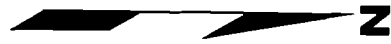
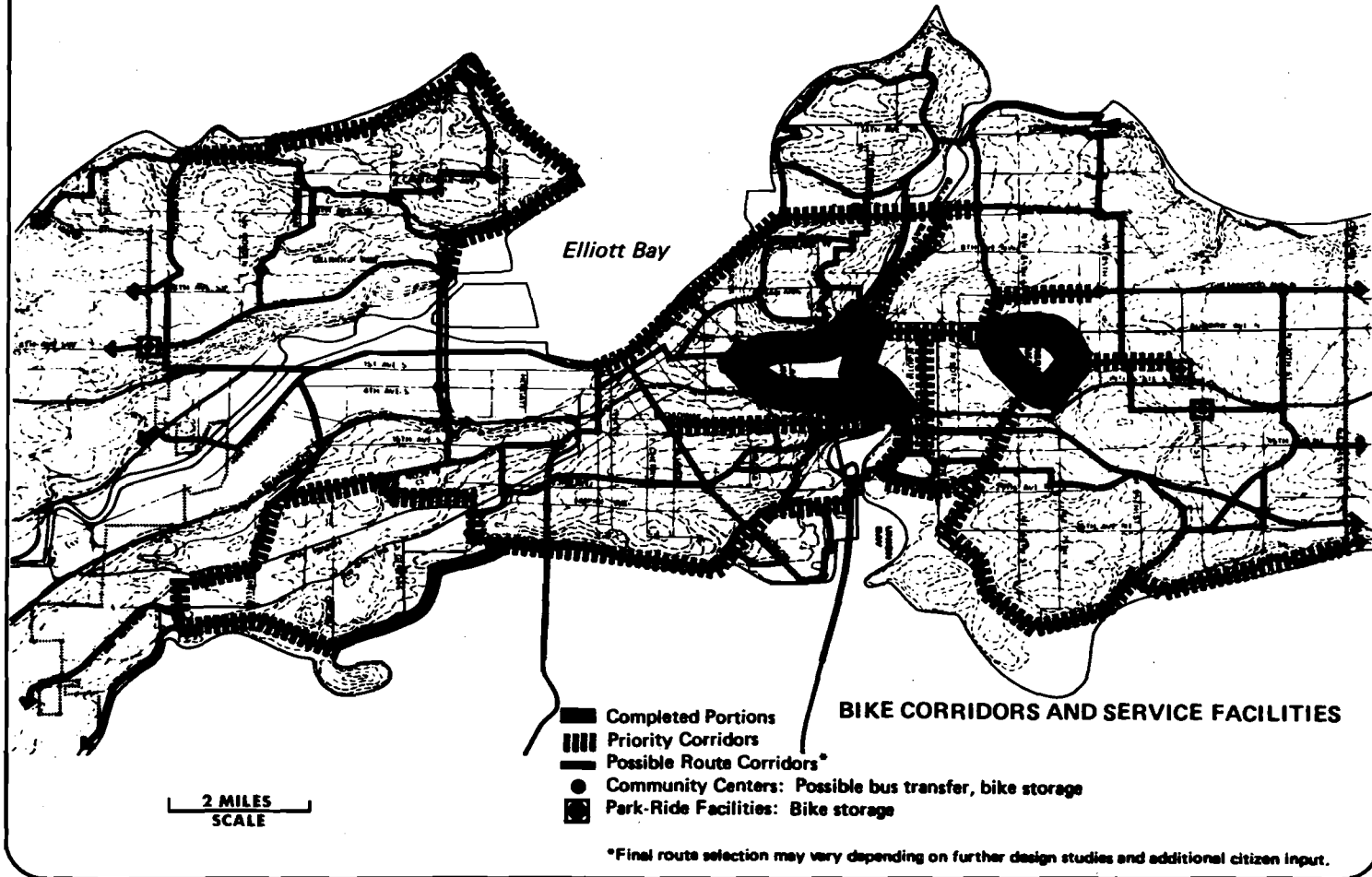
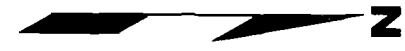

Figure IV-3 RADIAL PLANFORM

comprehensive bikeway plan



42

Figure IV-4 LOOP PLANFORM

comprehensive bikeway plan

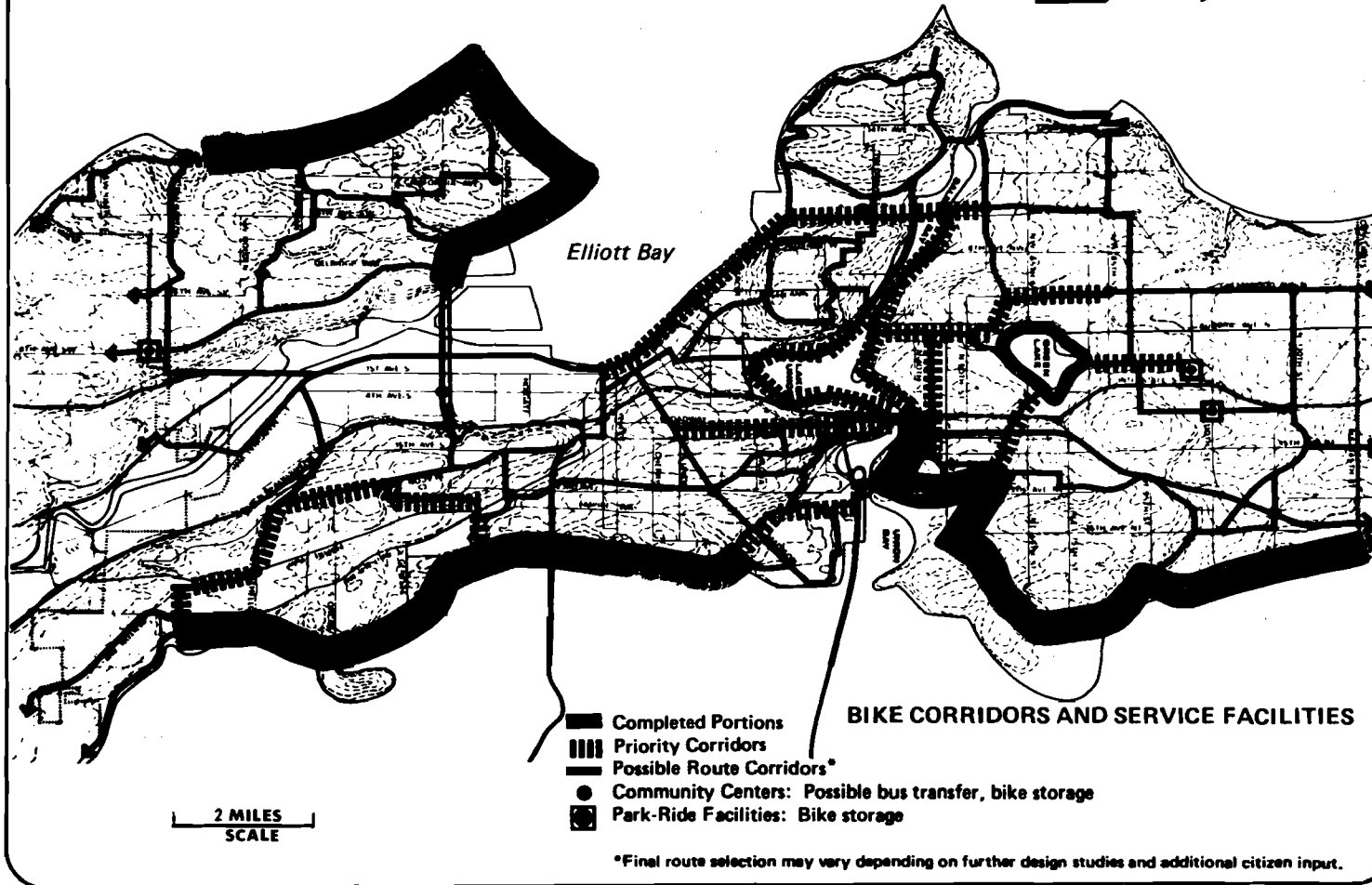

43

Figure IV-5 LINEAR PLANFORM

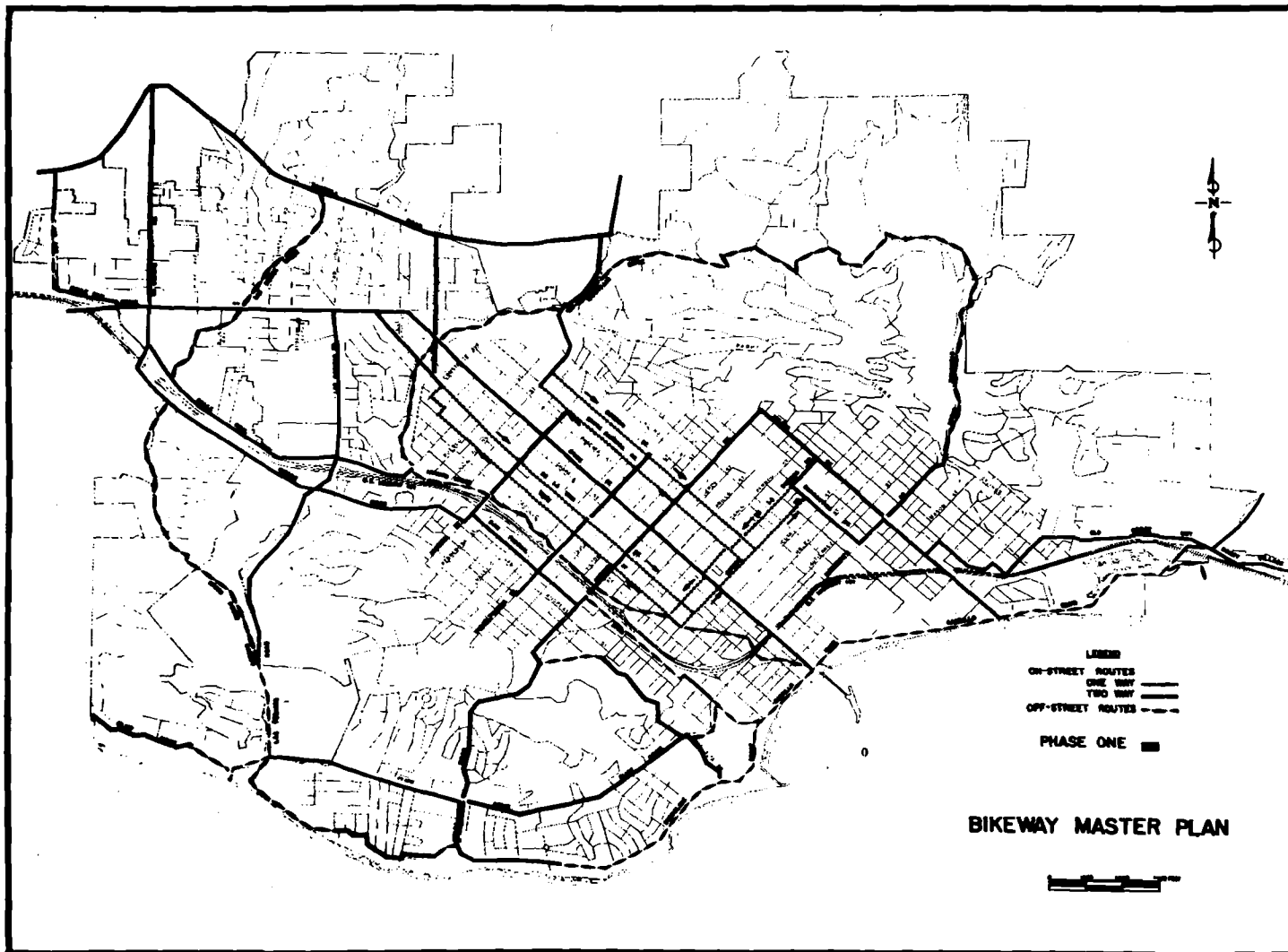

Figure IV-6 LINEAR PLANFORM SYSTEM NETWORK
 SOURCE: City of Santa Barbara, The Proposed
 Bikeway Master Plan

All bikeway network planforms serve the same basic function, that of circulation within the urban community. The degree to which they accomplish this goal and the orientation of the users best served is the essential difference between the various layouts and is a determinant in the final selection.

The Grid arrangement is principally for transportation with the spacing between the elements determining the density of service. As the expected trip length increases, the distance between the element also increases (4). For trips of 3 miles or more the spacing of bikeway routes to achieve maximum coverage is about one-half mile.

This network pattern can be modified to also serve a recreational purpose by placement of some links along attractive routes. The Grid planform fits into the existing roadway system of many American cities.

The Radial corridor system is primarily intended to serve bicycle transportation from residential neighborhoods to activity centers within the community. The length and frequency of bikeway corridors should be chosen to rationally serve the expected volume and area of trip generation. Recreational bicycling activity should be considered when determining corridor length and location.

The Loop bikeway system is often used to create continuous recreational routes. Bicyclists can enter at a variety of locations and complete their journey without retracing their paths. The system can be a series of interconnecting loops which provide for a large selection of trip lengths and recreational opportunities. Within the bikeway development plans of some communities a major bikeway loop has been placed external to the developed portion of the City. Recreational loops can be included within the Grid planform. A Loop can also effectively serve as a hub for a series of radial corridors. (See Figures IV-3 and IV-4).

A Linear bikeway system planform is often determined by the planform of the City and the topography which channels bicycle travel. Occasionally a linear corridor is the result of some local opportunity, such as use of an irrigation ditch property or an abandoned railroad right-of-way. The recreational/transportational purpose of this system arrangement will be dependent on the local desires rather than the planform because, to a great extent, it will be determined by the topography.

The Combination bikeway system network is the most common and can incorporate all of the desirable features of any of the above arrangements. A community can, through careful selection of planforms, combine them into an integrated system serving the principal bicycle orientation and capitalizing on local attributes. This approach provides the greatest flexibility.

REFERENCES (CHAPTER IV)

1. SB 355, State of Washington, 2nd Ex. Session (1972), Chapter 47.30 RCW.
2. Title 23, U. S. Code, Section 217.
3. Seattle, City of, Comprehensive Bikeway Plan, Seattle, December 30, 1972.
4. Seattle, City of, Bicycle Safety Study, Seattle, May, 1975, pp. 53-54.

CHAPTER V

SYSTEM INITIATION

CHAPTER V

SYSTEM INITIATION

This Chapter describes the structured process of moving from the newly defined total bikeway system to the beginning of a design for a facility. The progression includes System Prioritization, Development of Alternative Design Concepts, Analysis of Alternatives, and the Design Concept Selection. These steps are necessary to provide an orderly approach to system implementation in keeping with the expressed desires of the community and within the available financial resources.

The final three steps must be repeated for each new bikeway project under consideration. A reprioritization of the system is not required until major modification is made in the network or substantial change is evident in the community's wants.

BIKEWAY SYSTEM PRIORITIZATION

This section presents a rational method of developing an implementation list to assist in the most appropriate expenditure of community funds. The methodology (1) of prioritization consists of:

1. Structure all portions of the bikeway system for testing and forecasting. (The selections may not be optimal because not all solutions and consequences are known).
2. Identify the evaluation criteria.
3. Set values to the criteria by objective, analytic means or a subjective approach.
4. Compare relative values of each bikeway system element.

System Elements

The Bikeway System, for purposes of prioritization, can be considered as only the bikeway network, the bikeway network and its support facilities, or the local agency's entire bicycle facility construction program. Because most jurisdictions are able to provide very limited funding for meeting the bicycling needs of the community, the following discussion assumes that the entire program is under consideration.

The bikeway network consists of an arrangement of somewhat linear or circular bikeway corridors, each serving distinct purposes. The network must be disassembled into all of its logical links and loops and a tabulation made. The choice of each item should be consistent with the degree to which it serves its function. For example, a bikeway corridor from a residential area to a Central Business District which then continues to another residential area is, in fact, two separate

entities for prioritization. Likewise, a circular recreational loop of the entire community is considered as only one bikeway corridor. (In the latter case, a limitation of funds may influence the decision makers to by-pass this if it is a high priority, or to opt for a phased development over a period of years).

Another system element to be considered during prioritization is support facilities (see Chapter VI). Where these are considered integral in the development of a bikeway corridor this should be stated in the tabulation and included in the cost estimate. However, where the community program specifies the installation of such items as racks, lockers and showers to encourage greater use of bicycles (independent of bikeways), this activity must have a priority.

Another item which may be competing for the community's bicycle facility monies is a Bicycle Spot/Safety Improvement Program. The level of importance of this effort relative to the entire scope of bicycle work must also be established through the prioritization process.

Identification of Criteria

This step performs the basic function of insuring that all the factors influencing system prioritization have been considered. This is accomplished by setting down a check list of criteria by which all entries are evaluated. The following example illustrates the kinds of criteria that can be used:

A. Funding

1. What is the estimated cost of this element of the bikeway system?
2. Can it qualify for any special funding?
 - a. Local improvement programs.
 - b. Federal bikeway support programs.
 - c. Other.
3. Is right-of-way available?
4. Can it be included as part of an existing local, state, or federal project?

B. Policy Direction

1. To what extent does this element satisfy the orientation of the Comprehensive Bikeway Plan?

2. Is it consistent with expressed or implied City policies?
3. Is it consistent with local community group desires?
4. Is it consistent with City programs?
5. Is it consistent with County, State, or Federal programs.
6. What is the measure of political support?
7. Is this project likely to be called by court action?
8. To what degree does it interface with other City projects or programs?
9. To what extent does it interface with County, State, or Federal projects?
10. Does it encourage an alternative transportation mode?

C. Social Impacts

1. To what extent does this element minimize commuting distance (time) to job, shopping, school, etc.?
2. Does it maximize mobility and access within the community?
3. Does it increase mobility of the pre-auto young?
4. Will it increase business volume and sales?
5. Does it increase access to recreational facilities (parks, etc.)?
6. Will it increase personal safety?
7. Will it affect the community character?

8. Will it enhance the ability to "live in" the community?
9. Will parking demand be reduced?
10. Will the dependence on automobiles be changed?
11. Does it reduce automobile congestion?

D. Environmental Considerations

1. To what extent will this element separate motorized and non-motorized vehicle circulation?
2. Will it reduce the level of motor vehicle pollutants that the bicyclists encounters?
3. Will it remove trees, grass, or bushes?
4. Are scenic views affected?
5. Does it reduce noise?
6. Does it reduce air pollution?
7. Does it reduce the energy needs per capita per trip?
8. Does it encourage conservation of open space, green belts, and farm lands?

E. Operational and Safety Considerations

1. Is this element necessary for network continuity?
2. Does it reduce conflict between bicycles and motor vehicles?

3. Does it reduce conflict between bicycles and pedestrians?
4. Will the facility receive heavy use?
5. Are support facilities required?
6. What affect will it have on existing transportation systems?

Values

The following section presents two schemes for comparing the relative worth of each bikeway system element being considered; the benefit-cost analysis, and the cost-effectiveness analysis. The benefit-cost method requires all consequences to be measured with a common unit, dollars. The cost-effectiveness framework also uses dollars to measure costs but uses a scalar rating to judge the goal attainment of subjective items.

The scalar rating system used can range from a simple +,0,- method to a -5,0,+5 or 1 to 10 numerical scoring approach. The application of the larger range methods tends to spread out the total scores of all bikeway system elements under consideration and decrease the frequency of duplicate ratings. In addition, the use of the -5,0,+5 technique provides a definite null position and simplifies the decision making process. The wording of each criterion must explicitly indicate what a plus or minus choice will mean or an explanatory note should be added for clarity.

The most difficult part in defining the rating system is the establishment of relative weights for all of the criteria (2). The importance of increased mobility for the young, for example, may have a high priority in one community but be of much lesser magnitude in another. Each locality must determine its own trade-off rates between the various items. One approach that can be used is for this function to be a part of the Bikeway System Development effort. This would assure that the group most familiar with the goals, objectives and policies forming the system would prepare the relative weights. The information could then be part of an entire bikeway system plan to receive acceptance by City officials.

Selection of Priority

The final step in prioritization is the assignment of system implementation positions based on the most efficient allocation of bikeway system funds or the extent to which costs provide goal attainment (i.e., benefit-cost ratio, cost-effectiveness analysis).

Benefit-Cost Analysis

This method of measuring the efficiency of an action requires that all quantifiable criteria be set down using dollars as the means of measurement. Although the dollar value of many benefits and costs such as the funds necessary to design and build a bikeway, the anticipated reduction in bicycle/motor vehicle accidents, the increase or decrease in travel time to roadway users, are all readily obtainable, many items can only be subjectively evaluated. An attempt can be made to place a dollar value on these items with a high probability of error. Another approach is to ignore all items which can not be specified in dollars. A final technique is to describe the non quantifiables as an aid for the decision makers.

A tabulation of all bikeway system elements is made beginning with the bikeway corridor or bicycle program with the largest benefit-cost ratio and proceeding to that with the smaller B/C number.

Cost-Effectiveness Method

The Cost-Effectiveness approach is an informational framework to aid in the decision making process. Dollar costs associated with the bikeway system element under consideration are tangible resource outlays. These include the funds needed for facility design and construction, and the procurement of right of way. All intangible criteria receive a subjective scalar "grade" depending on the level of attainment of the objective (Figure V-1). The accumulated score of all criteria is, thus, a measure of how effective the particular bikeway system element is in satisfying the community desires.

A listing of all bikeway system elements is made ranking each in order to its accumulated effectiveness score and including the estimated costs of the facility (Table V-1). This information can also be presented graphically as shown in Figure V-2.

CRITERIA	BIKEWAY SYSTEM ELEMENTS					
	Bikeway No. ...	Bikeway No. 16	Bikeway No. ...	Spot/Safety Improve. Program	Bikeway No. ...	Bikeway No. ...
A.
B.
C. Social Impacts						
Minimize commute distance	0	+1
Maximize mobility	+2	+3
Mobility of young	+5	+5
Business sales	-2	0
D.
E.
TOTAL	63	49

FIGURE V-1 EXAMPLE: SCALAR RATING MATRIX

TABLE V-1
 EXAMPLE: AGGREGATED EFFECTIVENESS

Bikeway System Element	Costs (\$1,000)	EFFECTIVENESS (Scalar rating)
.....
Bikeway No. 16	112	63
.....
Spot/Safety Improvement Program	25	49
.....
.....

In addition to the tabulation with its supporting data from one of the two methods presented above, a recommendation for staged implementation of the Bikeway System should be made. This step provides the decision makers with a consensus opinion from responsible individuals from a variety of disciplines and with valuable insights into the specifics of the program.

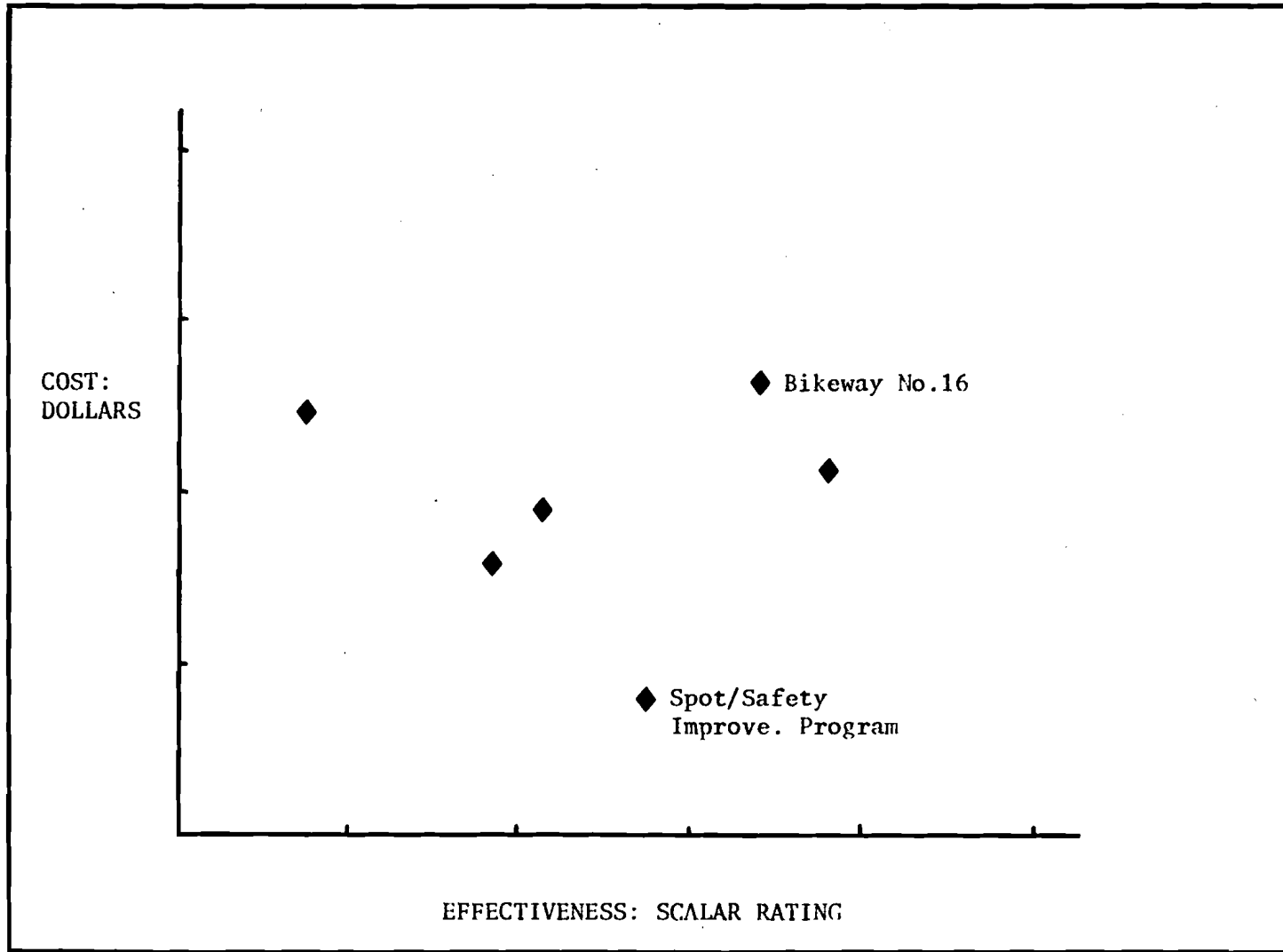

Figure V-2 COST-EFFECTIVENESS DIAGRAM

Development of Alternative Design Concepts

Once a corridor has been chosen for implementation, the process begins which is intended to result in construction of a facility. However, the project may be terminated at any time prior to construction because estimated costs become too high, the community opposes the location or design, anticipated funding is not available, or a myriad of other substantial reasons.

The first step in development of alternative design concepts is the route location study. All possible routes within the corridor must be considered and evaluated as to their degree of optimality. Items to be questioned are:

1. Convenience
Are there major impediments to bicycle travel along this route (frequency of stop signs, narrow bridges, etc.)?
Does this serve the desired bicycling needs (transportational or recreational)?
2. Safety
Will the safety of all roadway users be enhanced?
3. Feasibility
Can a bikeway be physically placed along this route?
What type?
4. Parking
Will a bikeway require removal of some parking? All parking?
What is the parking demand and turnover rate?
5. Access
Will a bikeway effect access to private homes, businesses, or the transit system.
6. Traffic Flow
Will a bikeway have an adverse effect on motor vehicle traffic flow along this route? Within the area?
7. Community Response
Is this a desired location?
What impact will result to other desirable community features?
8. Transportation Systems
How will this facility affect the transit systems?
Goods movement?
9. Commerce
Will businesses be affected?
10. Cost
What is the probable cost of this facility?

The routes within the corridor should be inspected (preferably by bicycle), and essential data gathered and reviewed. Forecasts of expected bikeway use should be prepared.

After sufficient preliminary planning work has been concluded, the results should be presented to the community for its response. This generally will result in one route being selected for further expansion. To aid in the route selection process a scalar rating matrix, similar to that described in the Cost-Effectiveness technique, can be used. It is also important to identify the range of bikeway facility types for which construction within the corridor is possible.

Once the bikeway route has been established, a procedure like that of route location must be performed to identify the universe of design possibilities. In this case, however, a more intensive investigation is performed using more specific, detailed information.

A method has evolved which can best be described as an incremental approach. Each specific design element along the route is viewed isolated from all others. All possible alternative solutions are developed for that element and the advantages and disadvantages of the alternatives are identified. A recommendation is made for each solution based on its advantages and disadvantages measured against established planning, design and operational criteria. A matrix of all feasible design solutions, disregarding the recommendations, is created which ties all possible solutions together in a continuous fashion along the route. An analysis of this matrix and the sketches depicting geometric design solutions quickly eliminates many combinations as being relatively unsafe, too costly, not feasible from a traffic operation standpoint, or not meeting the planning or design criteria. The design concept solutions that remain can be evaluated and a final selection made.

ANALYSIS OF ALTERNATES

A design and construction cost estimate should be made for each of the remaining design concepts. Those which exceed the project limit should be eliminated. Those which remain should be evaluated using one of the two evaluation frameworks presented above: Benefit-Cost Analysis or Cost-Effectiveness Analysis.

DESIGN CONCEPT SELECTION

The bikeway concept selected for design will usually reflect the highest attainment of the urban community's goals and objectives within an acceptable cost.

REFERENCES (CHAPTER V)

1. Thomas, Edwin N. and Joseph L. Schafer, "Strategies for the Evaluation of Alternative Transportation Plans", HRB Hwy. Res. Report 96, (Washington: 1970) pp. 43-44.
2. Ibid., p.50.

CHAPTER VI

BIKEWAY DESIGN

CHAPTER VI

BIKEWAY DESIGN

INTRODUCTION

The preceding chapters furnished the methods for developing an urban bikeway system network and identifying the location and design concept of a bikeway to be built. This chapter discusses the many items that need to be considered throughout the bikeway design process and presents some of the variations that have been used or commented on in publications.

During the past five years, many agencies, organizations and individuals have written material dealing with the subject of bikeway design. Much of the criteria used were based on European standards. Often the publications were restatements of works previously released. Frequently, some important elements of the design effort were not addressed. Bikeway design documents produced by persons with experience in bikeway design, construction and evaluation are rare. This chapter will attempt to synthesize much of the published material drawing heavily from the most authoritative sources and this agency's three-year involvement in providing bikeway facilities.

The principal orientation of the system, whether for commuting or recreational purposes, will have a strong bearing on the design decisions. The needs of each type of bicycle operation are not always the same. For example, the bikeway width required for commuting can often be less than for a purely recreational facility. Inherent with recreational bicycling activity is group riding with numbers of persons desiring to ride side-by-side. This is not the rule with commuter operation. In addition, the "shortest path" demands of commuter bicyclists frequently dictate the use of arterial roadways. The competition for street space between moving and parked motor vehicles, pedestrians, and bicycles generally will militate against a bikeway width greater than the minimum consistent with safety.

In order to provide the most effective design alternatives the designer should have skill in operating a bicycle, knowledge of its operational limitations, and an understanding of the characteristics and needs of all users of the roadway or path. It is recommended that this position be held by a competent traffic engineer, or similarly trained person, well versed in geometric design, traffic control and highway safety. Skill in public speaking and written communication is essential in promoting the ideas involved in this little known activity. The bikeway designer should also be receptive to the comments and suggestions of the citizens.

The following sections deal with specific design elements and reflect the current state-of-the-art. Knowledge in bikeway design is in its infancy. Where the design techniques presented in this manual, or other bikeway publications, do not satisfy a community's needs, the designer is encouraged to innovate. It is important that this information be viewed as a guide rather than a set of hard and fast design standards from which deviations are never allowed.

This chapter is divided into sections dealing with the following subjects: definitions; bikeway location; geometrics; bikeway structure; culverts and other drainage; intersections and crossings; grade separation; signs and markings; signalization; lighting; support facilities; and maintenance.

DEFINITIONS

One area of bikeway design in which agreement is lacking is the definitions for the various types of bicycle facilities (1). In fact, even the term "bicycle facility" has been broadened at times to include the items used to encourage bicycling, such as bicycle racks, litter cans, and rest stop accommodations.

The term "bicycle facilities" used in this chapter will mean bicycle travel ways within the highway right of way or on paths separated from the right of way, and is consistent with its use by the State of Washington (2), the American Association of State Highway and Transportation Officials (3), and the Federal Highway Administration (4).

The bicycle facility terms and their definitions used throughout this chapter are:

Bike Route - A street or system of streets and ways with signs denoting them as a "Bike Route". The signs advise motorists to anticipate bicycles on these streets and indicate to cyclists a desirable routing because of low traffic volumes, good grade profile, a possibility of scenic views or continuity to activity centers. Most commonly, "Bike Routes" imply streets in mixed usage but they may include segments of the various types of bicycle facilities described below. In noncapitalized form, "bike route" indicates the bicycle's line of travel to reach a specific destination.

Bikeway - The generic term which includes all bicycle facility treatments described below. A greater degree of safety and exclusiveness is explicitly provided the bicycle operator on these facilities than is normally provided within the city for bicycle operation.

- Sidewalk Path - A sidewalk which, because of safety or convenience to the bicycle operator, is shared with pedestrians. Bicycles must yield right of way to pedestrians in conflict situations.
- Bicycle Street - An entire roadway set aside exclusively for bicycle use or where motor vehicles must yield right of way to bicycles in all conflict situations.
- Bike Lane - An on-street treatment in which separate motor vehicle and bicycle travel lanes are designated by signs and street markings or barriers.
- Bike Path - A bicycle facility separated from the roadway system either within or beyond the street right-of-way.

LOCATION

The decision on whether to locate a bikeway on the roadway, on the sidewalk, or to construct a new path along the proposed bikeway alignment is dependent upon a variety of factors. All identifiable deficiencies should be considered, along with possible compensating measures, in the selection process.

Bike Path

The selection of an independent or separate Bike Path over all other forms of bikeway types is urged in many bikeway design publications. In the urban environment, however, it is often not possible or desirable to construct new pavements. In fully developed portions of the city, the only space to incorporate a bikeway may be on the roadway or sidewalk. Where room is available in which a path can be built, the aesthetic considerations of maintaining the grass and trees must be weighed against the advantages of a facility independent of other travel modes.

The separate path usually permits bicycle travel with less conflict with motor vehicle traffic. Where a higher level of safety is not possible, because of the frequency of intersecting streets or property access requirements, the feasibility of this bikeway alternative should be questioned. A distinct advantage of this bikeway treatment for the bicyclists, where desired alignment, available space and topography permit, is the possibility of spatial separation from air pollution caused by internal combustion engines. The scenic possibilities for the recreational bicyclists are enhanced by the deviation from the normal travelways that the independent path provides.

Bikeway on Roadway

Within most of the urban area the roadway will provide the most desirable space for bikeway development. Not only are bicycles presently sharing the streets with motor vehicles (often viewed by the motorists as an unwanted intruder) but even as greater amounts of bikeway miles are implemented, most bicycle miles of travel will continue to be in mixed traffic for many years to come. Therefore, the experience of both motorist and bicyclist in a controlled environment provided by an on-street bikeway will have benefit for shared operation on non-bikeway streets.

The questions of where to place the bikeway on the roadway and the techniques to use in physically defining it have a strong influence on the effectiveness of the facility from a safety and attractiveness standpoint. The Bike Street and Bike Lane are two approaches that can be used.

Bike Street

The Bike Street provides an improved level of safety to the bicycle operator by establishment of an exclusive or preferential roadway for bicycle travel. This is accomplished through regulatory signing, in conjunction with "bikeway" signs, which either restrict the entire roadway from use by motor vehicles or makes mandatory that motor vehicles yield to bicycles in conflict situations. This latter technique was first used in the City of Seattle in 1973 (Figure VI-1).

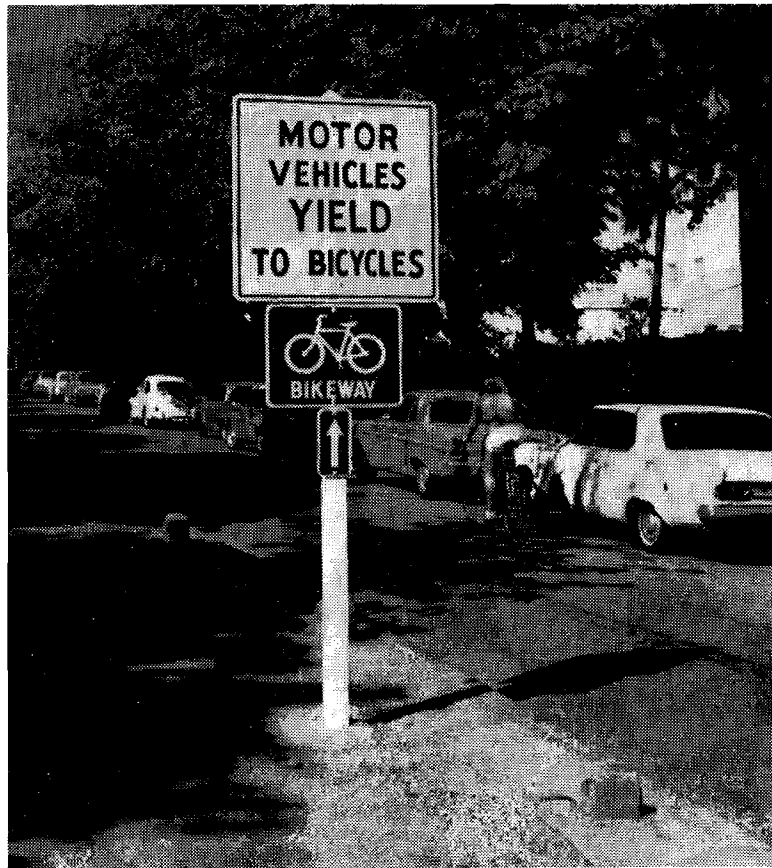

Figure VI-1 BIKE STREET
Seattle, Washington

This method is most applicable to those streets with low motor vehicle volumes, speeds and parking turnover rates.

Bike Lane

The presence of a defined Bike Lane on the roadway can be an effective means of separating the flow of motor vehicle and bicycle traffic. This allocation of roadway space, in addition to decreasing the accident potential between the two transportation modes, may result in increased roadway motor vehicle capacity and volumes by removal of the impediment caused by the slower bicycles.

Bicycle lanes are generally located along the right margin of a roadway, either in conjunction with parked cars or with parking restricted. When parking is allowed the bicycle traffic should operate in the space provided between the parked motor vehicles and the adjacent travel lane or between the roadway margin and the parked cars which are a prescribed distance away (Figure VI-2).

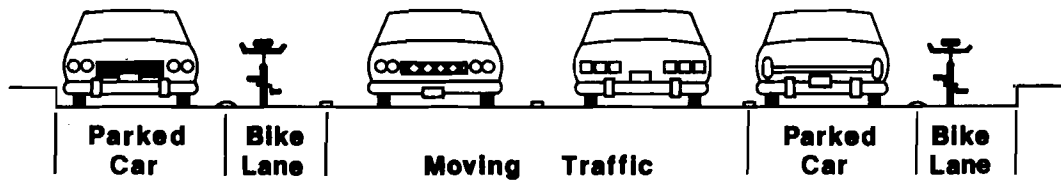

Figure VI-2 BIKE LANE/PARKING OPTIONS

In some cases on one-way streets and in divided roadway configurations (Figure VI-3) the bike lane can be located in the left lane on the roadway.



Figure VI-3 LEFT LANE BIKEWAY PLACEMENT
Seattle, Washington

Where the roadway width is not sufficient to enable parking to remain on both sides of the street and incorporate a bikeway facility, two alternate solutions are feasible (Figure VI-4). A single direction

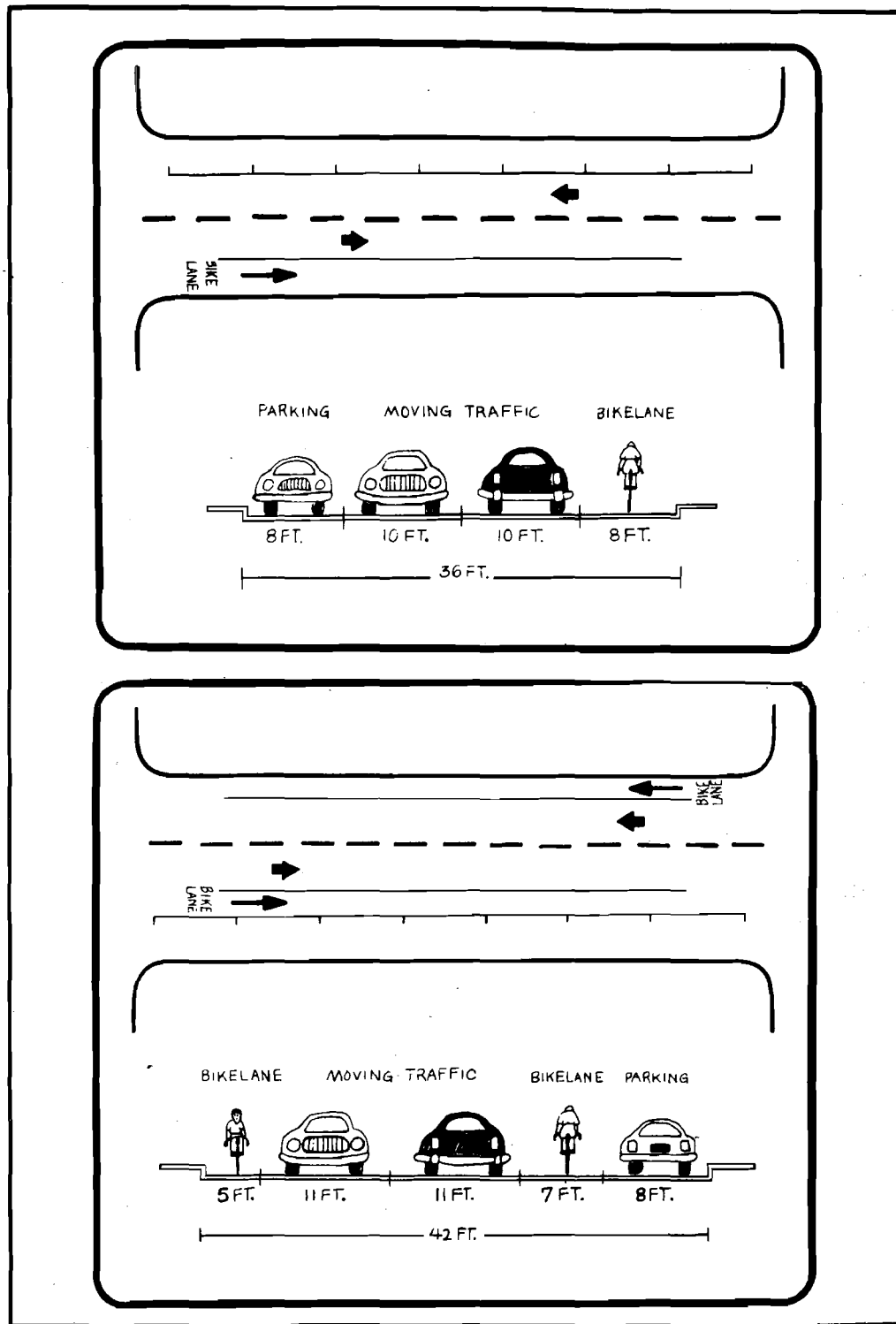

Figure VI-4 BIKE LANE OPTIONS

SOURCE: City of Santa Barbara, The Proposed Bikeway Master Plan

bike lane can be provided on one roadway and a bike lane provided in the opposite direction on a parallel street to create a "one way couplet" (5). The other approach is to remove parking from one side of the roadway and offset the roadway centerline and all other traffic lane lines (6).

A two-directional bike lane can be located on one side of the roadway (Figure VI-5).



Figure VI-5 TWO DIRECTIONAL BIKEWAY
Seattle, Washington

There are three major concerns that need to be addressed regarding this placement:

1. Motorists approaching an intersection with a roadway which has a two way bikeway on the near side will normally be monitoring nearside traffic to their left and far side traffic to their right. The near side bikeway traffic on the right will not be expected, with the possibility of a collision occurring. A similar condition exists with the bikeway on the far side. In this case, however, it is the bicycle traffic coming from the left that is the problem. Accident history on analogous bikeway situations in the Netherlands supports this contention (Figure VI-6).

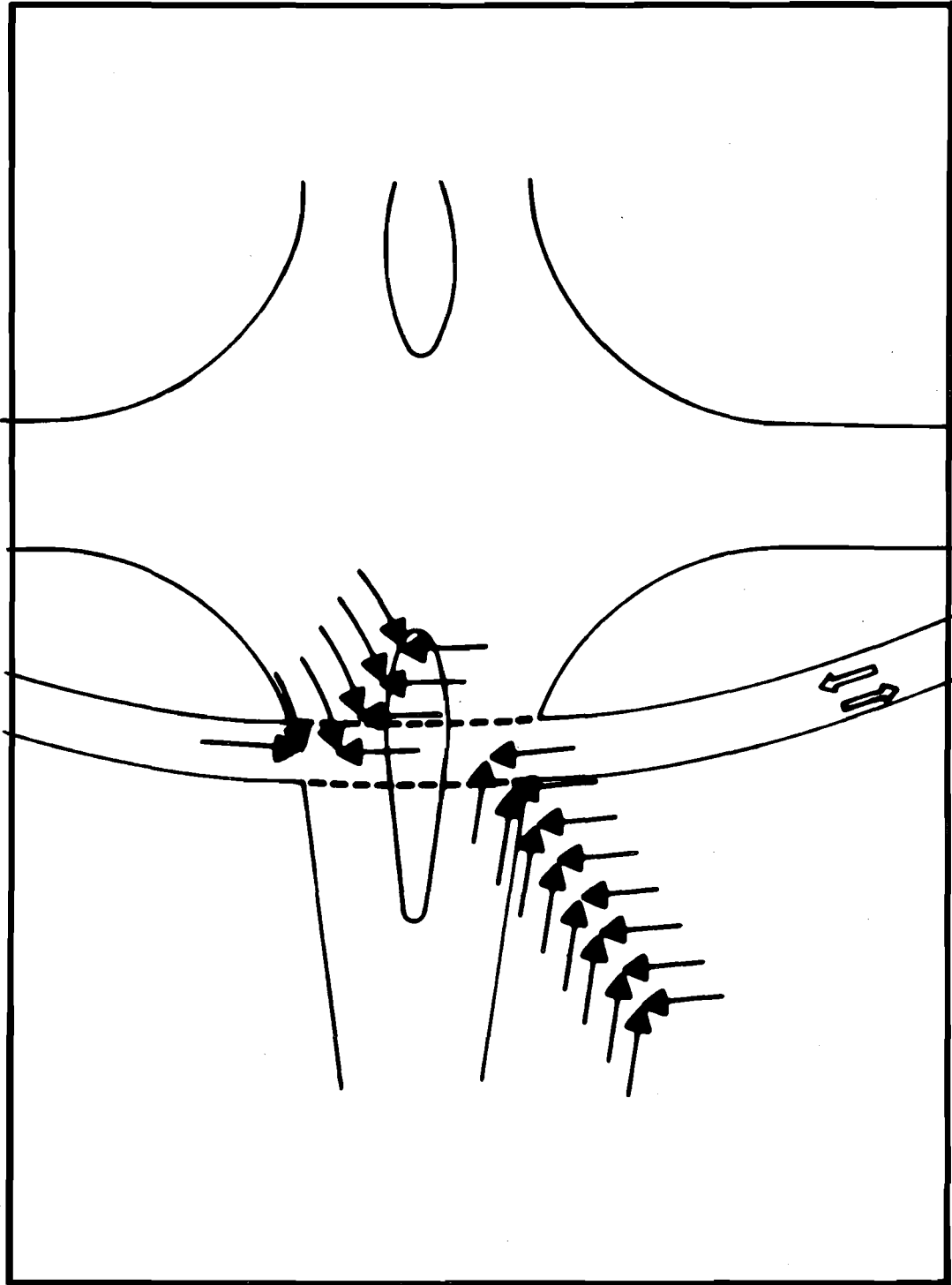

Figure VI-6 TWO DIRECTIONAL BIKEWAY
ACCIDENT HISTORY (THE
NETHERLANDS)

SOURCE: Deleuw, Cather & Co., Davis Bicycle
Circulation & Safety Study

2. Encouragement to ride "wrong way" on a roadway may carry over to nonbikeway streets. This behavior is a major cause of accidents in some communities. Additionally, at least one state, Washington, requires a physical barrier, (i.e., curbing, islands, etc.), where bicycles are directed to operate opposing adjacent motor vehicle traffic.
3. Beginning and terminating points of the two-directional bike lanes need careful attention to eliminate the potential for induced "wrong way" travel.

Many different methods have been used to delineate the bike lane on the roadway. Painted stripes of various colors and arrangements, cones, traffic buttons, mountable and nonmountable curbing, raised berms, traffic bars, and even planter boxes have been utilized as symbolic and physical barriers between the bicycle traffic and the other roadway users.

Although physical barriers can provide greater safety for the bicyclists along the route, they can also create problems. Unless sufficient space is allowed between the roadway curb and the device separating the bicycle from the roadway traffic, the bicycle operator will be confined and will not have the maneuverability needed to avoid an incident. In areas requiring frequent driveway access to residential or business property, the barrier could be discontinuous to the point of noneffectiveness. Some communities have experienced an increase in "wrong way" travel along protected bike lanes, resulting in bicycle/bicycle conflicts in addition to the bicycle/motor vehicle conflicts noted above for two-directional bike lanes. Unless the bike lane width is sufficiently wide to allow passage of maintenance equipment, debris will collect or costly hand cleaning will be necessary. The choice of which bike lane demarcation to use should also consider snow removal maintenance and water drainage for the entire roadway.

It should be recognized as axiomatic that any separation device placed in the roadway will at some time or another be struck by motor vehicles and bicycles. The certainty that this will happen should be anticipated by the designer and measures taken to counteract any harmful effects.

Parking

A major concern in urban areas in determining if a bikeway can be placed on a roadway, is its effect on the existing on-street parking capacity. If the roadway under consideration is not sufficiently wide to install a bicycle facility without removing some parking, and no acceptable alternate bikeway route is available, studies must be made to identify who will be affected and to measure the implications of the proposed action.

Preparation of a block-by-block diagram showing truck loading zones and bus stops, in addition to automobile parking areas, no parking and limited parking areas, and other specified curb side uses, is very valuable. This graphic representation will assist the designer in presenting the gathered parking information to the property owners and the decision makers if, in his judgement, parking removal is to be pursued.

Each side of every block must be checked on a typical day to determine the percentage of available parking utilized on a daily, peak period, and hourly basis. In addition, the "turnover rate" should be assessed by checking the parking duration of vehicles through a comparison of license plate numbers. Along streets which indicate a high frequency of turnover constant scrutiny may be necessary to fully determine the extent of parking demand.

Knowing the destinations of those using the parking spaces can provide greater depth to the inquiry and assist in the final decision. This information is obtained by direct survey of the occupants of the motor vehicles as the occupants leave or return to their cars.

If the studies show that no general negative impact will occur from the removal of parking along the route, each property owner and business should then be contacted individually. It is advisable that the bikeway designer be prepared with alternative roadway operational strategies to assist him in his contacts. Such items as relocation of a truck loading zone, substitute parking areas on adjacent streets, a limited time period for bikeway operation or a restriction on when commercial vehicles and automobiles could use curb-side parking, or a relocated bus stop should be evaluated prior to meeting with the affected persons.

Bikeway on Sidewalk

In those communities where bicyclists are permitted by law to use the sidewalk, it can be considered as another potential bikeway location. In order to induce sidewalk usage by bicycle operators there must be smooth ramp transitions at curbs and other abrupt surface elevation changes. However, the disadvantages of a sidewalk bikeway must be clearly recognized and the decision to use it based on a judgement that it is the best available alternative.

Figure VI-7 shows two problems associated with sidewalk bikeways. Except in areas where pedestrian volumes are low, frequent conflicts can occur between the quiet, faster moving bicycles and pedestrians with their unpredictable movements. It is possible to alleviate this situation by requiring bicyclists to yield to pedestrians, by identifying lanes for bicycle and for pedestrian travel, or by widening the sidewalk. However, the problem of conflict with motor vehicles at street intersections and at driveways remains. In some cases, because of parked automobiles, trees, shrubs, and other obstacles, the turning motorist will not be able to establish visual contact with a bicycle on the sidewalk prior to the intersection. It is also difficult to control

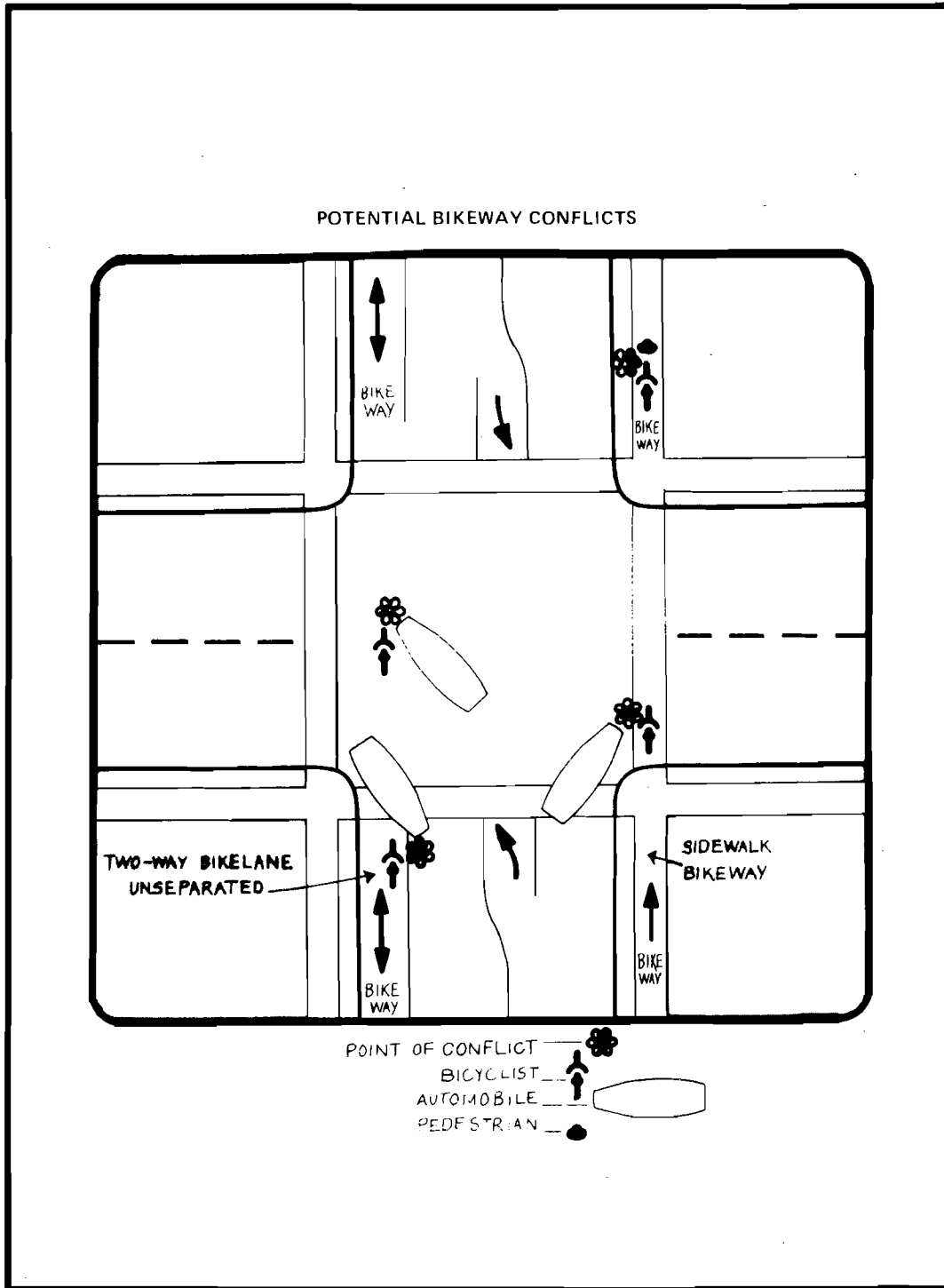

Figure VI-7 POTENTIAL SIDEWALK BIKEWAY CONFLICTS

SOURCE: City of Santa Barbara, The Proposed Bikeway Master Plan

the direction of bicycle movement on the sidewalk with the resultant bicycle/bicycle conflict in addition to increased friction with pedestrians. The composite operational situation would be analogous to a two-way bike path with pedestrians included.

Bike Route

The signed Bike Route is not included in the foregoing discussions as a Bikeway because it provides no special features to separate bicycles from motor vehicles.

"The signed bike route or route system has typically been the first step in many jurisdictions' attempts to deal with the bicycle activity boom. These Class III facilities may be the product of significant efforts on the part of the planner to indicate to cyclists utility routes with continuity to activity centers having low traffic volume or desirable grade profile characteristics, or recreational routes having the possibility of scenic views, continuity to points of interest, and recreational facilities. However, beyond the measure of safety which may accrue as a result of the route signs being seen by alerting drivers to anticipate cyclist, signed route facilities typically do little to insure bicycle safety (7)".

GEOMETRICS

The speed, convenience, enjoyment, and safety of bicyclists operating on a designed bikeway facility will be dependent in part on the attention given to certain geometric features.

Bicycle Speed

The maximum speed attainable on a bicycle is a function of a number of factors: the grade of the roadway and the smoothness of its surface, the condition and type of bicycle, the wind direction and force, and the physical ability of the bicyclists. Although many design publications recommend a bicycle speed of 10 mph the criteria should take into account the climbing and descending grades many communities must consider in a bikeway design. The approach used by the Oregon State Highway Division in setting a speed criteria seems appropriate:

"A design speed of 20 mph shall be used for bikeways with grades between + 3 percent and - 7 percent. Sections with grades steeper than - 7 percent shall use a 30 mph design speed and one-way climbing grades of + 3 percent or more may use a 15 mph design speed." (8)

Stopping Sight Distance

The safe-stopping sight distance of a bicycle is a function of the speed, the time it takes for the operator to perceive the need to stop, the reaction time to apply the brakes, the frictional coefficient of the tire tread and the roadway surface, and the grade of the roadway. It is stated mathematically below (9):

$$S = 1.47 PV + V^2 / 30 (f \pm g)$$

where: S = stopping distance in feet

P = perception/reaction time (usually about 1.0 seconds for urban conditions) (10)

V = design speed in MPH

g = grade, ft/ft (+, ascending; -, descending)

f = coefficient of friction (.25 - based on a one-wheel stop on a dry, paved surface; a wet surface would reduce this figure approximately one half) (11).

Note: At 15 MPH a bicycle travels 22 feet during a one second perception/reaction time.

No definitive studies have been made to quantify the braking ability of many different bicycle braking systems. Experience would tend to indicate generally that wet caliper brakes will increase the total stopping distance from five to ten times. Where potential hazards may be caused by limited sight distance during wet weather, prior warning signs may be appropriate.

Sight clearances at the intersection of a bikeway and a roadway are very important. This is especially true where a Bike Path crosses a roadway and the bicycle operators may fail to use good judgment in their approach speeds. Providing good visual clearance and adequate stopping distance will tend to reduce accident potential. Figure VI-8 shows a method for calculating sight clearances.

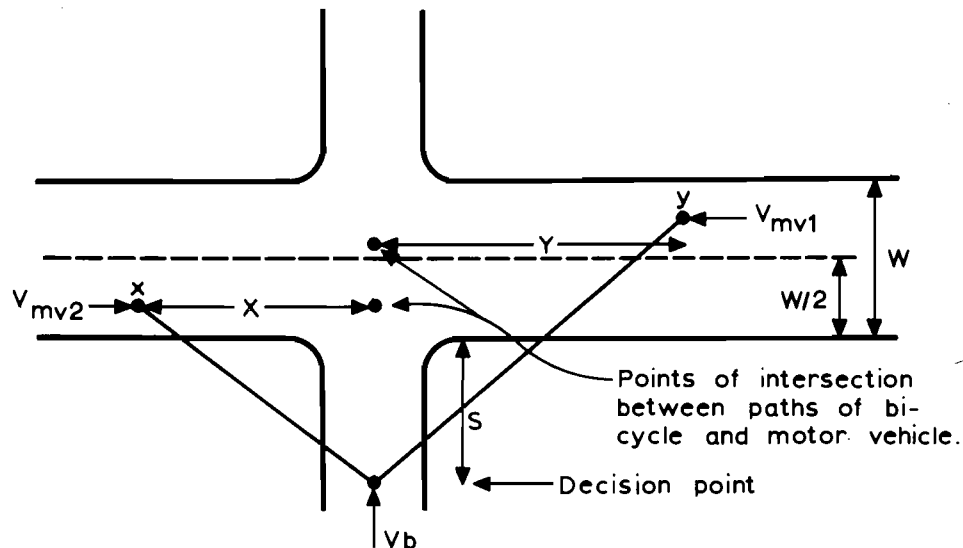

Time for full intersection clearance from the "stop-go" decision point plus a safety factor is given by:

$$\frac{S + W + 20}{V_b} = t_1$$

Where

S = Safe stopping distance

W = Width of crossing

V_b = Typical bicycle approach speed

V_{mv} = Typical motor vehicle approach speed

Time for near side lane(s) clearance is given by:

$$\frac{S + W/2 + 20}{V_b} = t_2$$

A crossing cyclist at the "decision point" must be able to see any vehicle which would threaten conflict in the crossing within time t_1 or t_2 . Thus, the cyclist at the decision point must be able to see approaching vehicles at the following distances:

$$\text{Far side } Y = t_1 V_{mv1} = \frac{V_{mv1}}{V_b} (S + W + 20)$$

$$\text{Near side } X = t_2 V_{mv2} = \frac{V_{mv2}}{V_b} (S + W/2 + 20)$$

Figure VI-8 SIGHT CLEARANCES

Note: This illustration is based on information presented in U. S. Department of Transportation, Bikeways-State of the Art-1974

Horizontal Curves

Another bikeway design consideration affected by speed is the bikeway radius of curvature. Figure VI-9 shows the relationship of velocity and radius based on an acceptable bicycle lean angle (see Appendix for derivation of the curve). The Bike Path surface used in this illustration is assumed to be smooth, firm, free of loose debris, and without superelevation.

Superelevation

The use of superelevation is generally recommended with the qualification that more study is needed to determine its effectiveness. The State of Oregon has developed a series of bicycle speed curves to guide in the selection of bikeway curvature and superelevation (Figure VI-10).

Additionally, Oregon requires all curves on a two-way bikeway with a radius of 200 feet or less to be widened, so as to compensate for the increased lateral space occupied by the bicyclist leaning into the curve. Figure VI-11 illustrates the technique for calculating the necessary path variation.

Vertical Curves

The design of cresting or sagging vertical curves along a Bike Path should take into account a number of important items. Unfortunately, no data has been developed as an aid to the designer and the evaluation must be subjective.

The sight distance of the bicycle operator while on the curve to converging motor vehicles, pedestrians, or bicycle traffic, and his day and nighttime visibility, are major concerns. Also, the transitions to and from the curve should be gradual to provide the greatest comfort and safety to the users. Methods should be used to limit the bicyclists approach speed where topography or other constraints result in an abrupt curve. The techniques to accomplish this are covered later in this Chapter.

Grades

The subject of what is an acceptable grade has been discussed in most publications dealing with bikeway design. Much of the information presented has been based on studies made in Europe that dealt only with ascending grades. Table VI-1 illustrates the confusion nationally on this subject.

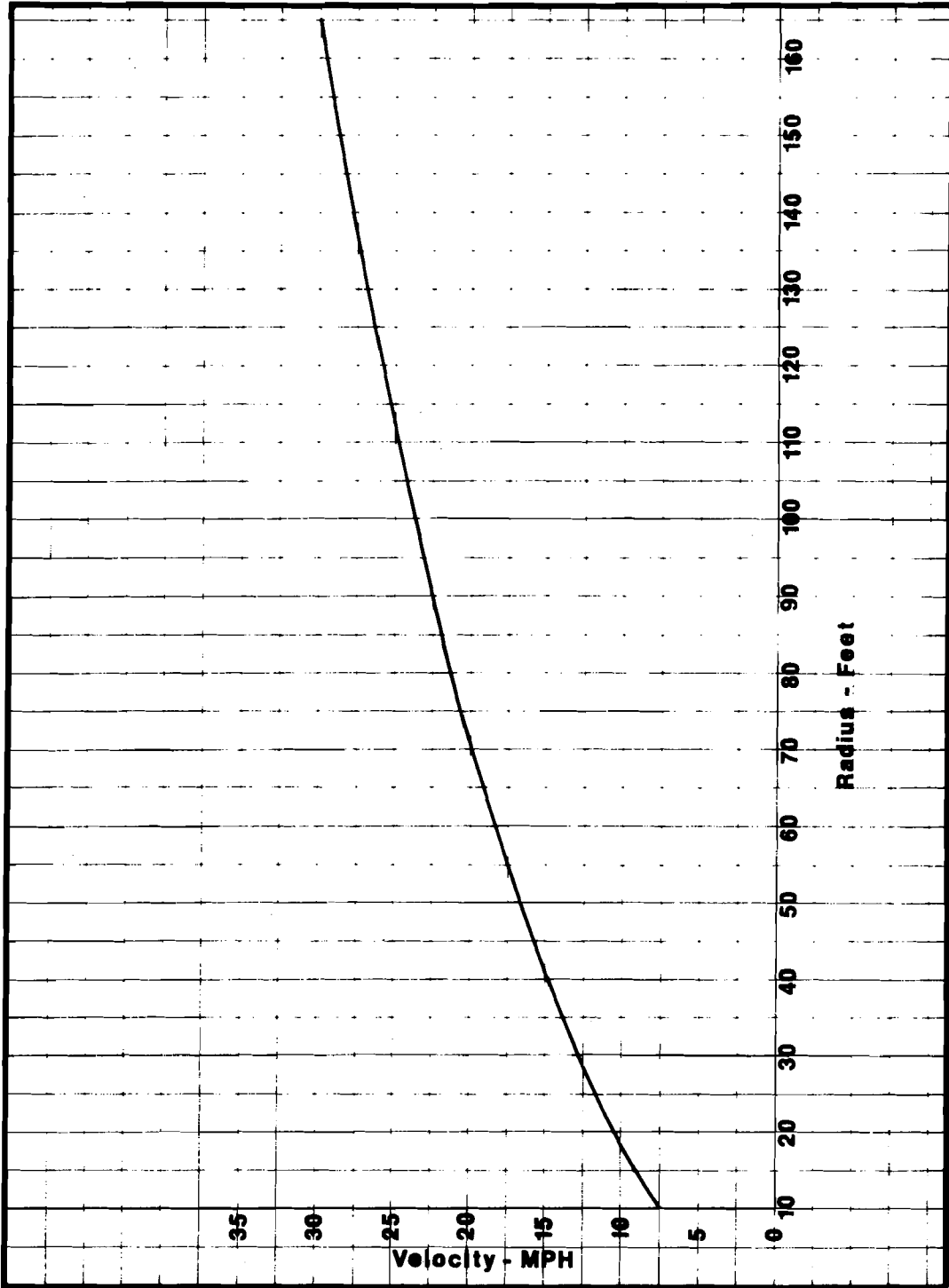

Figure VI-9 RADIUS OF CURVATURE/SPEED RELATIONSHIP

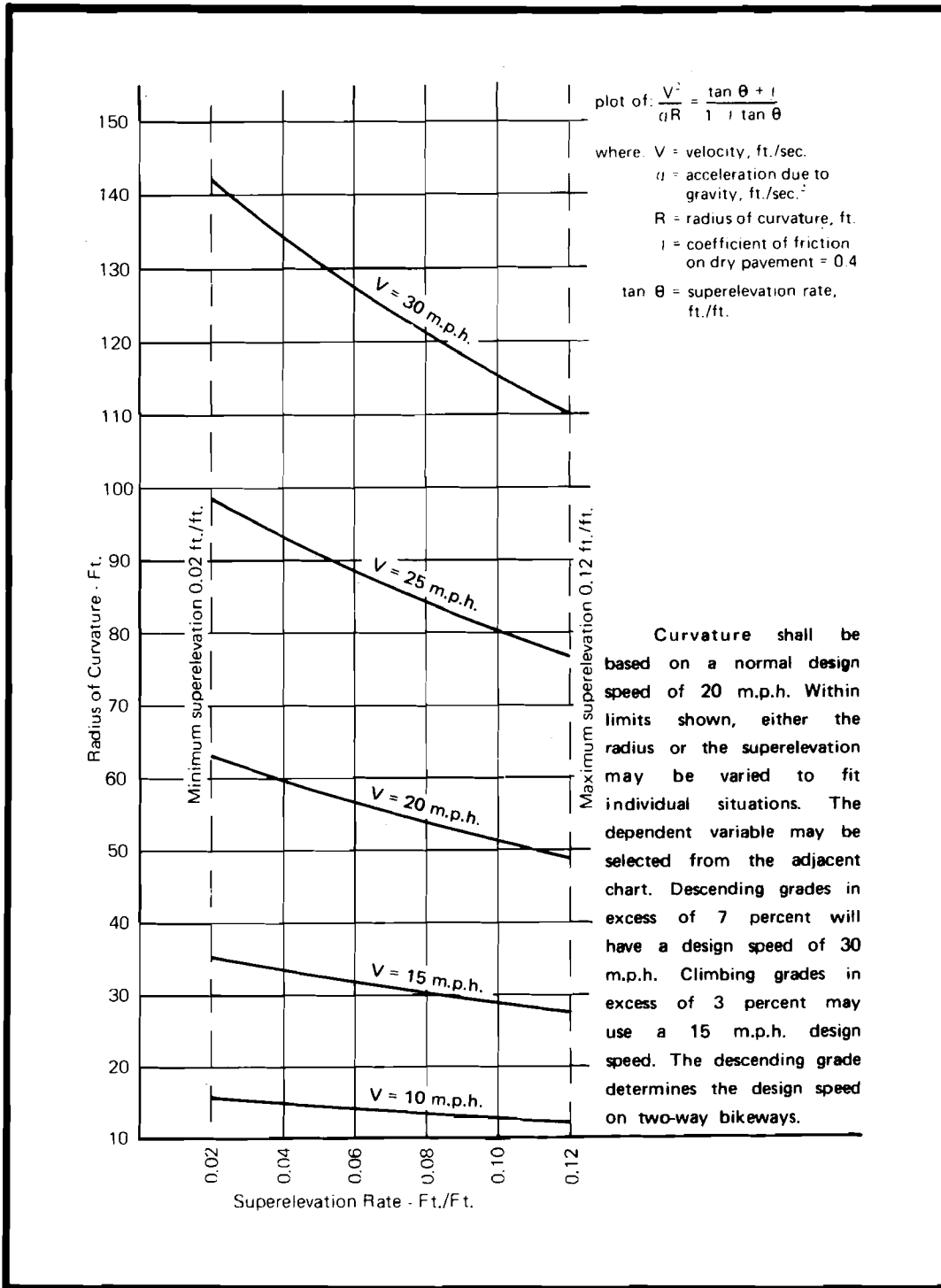

Figure VI-10 SUPERELEVATION EFFECT ON SPEED/RELATIONSHIP

SOURCE: State of Oregon, Bikeway Design

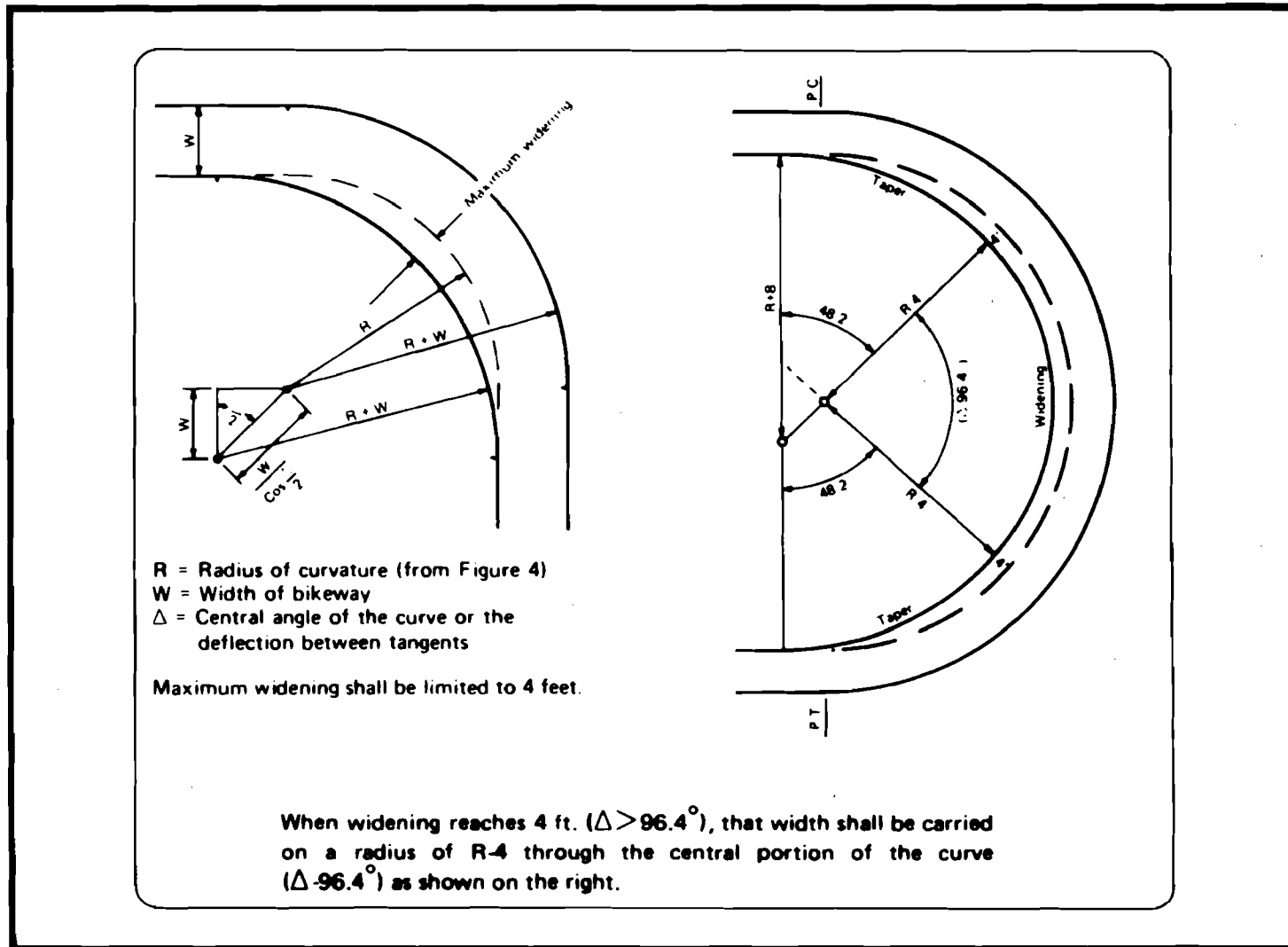

Figure VI-11 CURVE WIDENING

SOURCE: State of Oregon, Bikeway Design

TABLE VI-1
GRADE RECOMMENDATIONS

Recommendation	Washington State (2)	AASHTO (3)	Oregon State (11)
Maximum		10	10*
Tolerable			10(50')
Short	10(<200')		
Sustained	8(<500')		
Desirable	6	5(<100') 2(<500')	4.5
Avoid		5(>300') 2(>1500')	

* Grades in excess of 10 percent require approval of Location Engineer.

The State of Oregon (12) further refined the "Desirable Grade" selection by providing a curve to assist in making the design judgment (Figure VI-12).

Unfortunately, all of this information fails to consider two important items in grade selection: the general bicycle operating habits in the local community regarding terrain, and the safe operation of the bicycle descending grades under adverse conditions (i.e. wet caliper brakes, wet or icy pavement, etc.).

The ascending grades normally encountered and accepted by bicycle operators in Seattle, Washington, would probably be considered intolerably steep in the Midwest. Until more study has been done and better guidelines established, the bikeway designer should limit the choice to grades accepted locally.

Because of the lack of any studies on bicycle braking system effectiveness under varied climatic conditions, the designer must rely on a subjective judgment in choosing acceptable descending grades. As stated earlier, the bikeway designer should have the necessary bicycle operating skills and experience to enable many conclusions and decisions to be based on the real needs and problems of bicyclists.

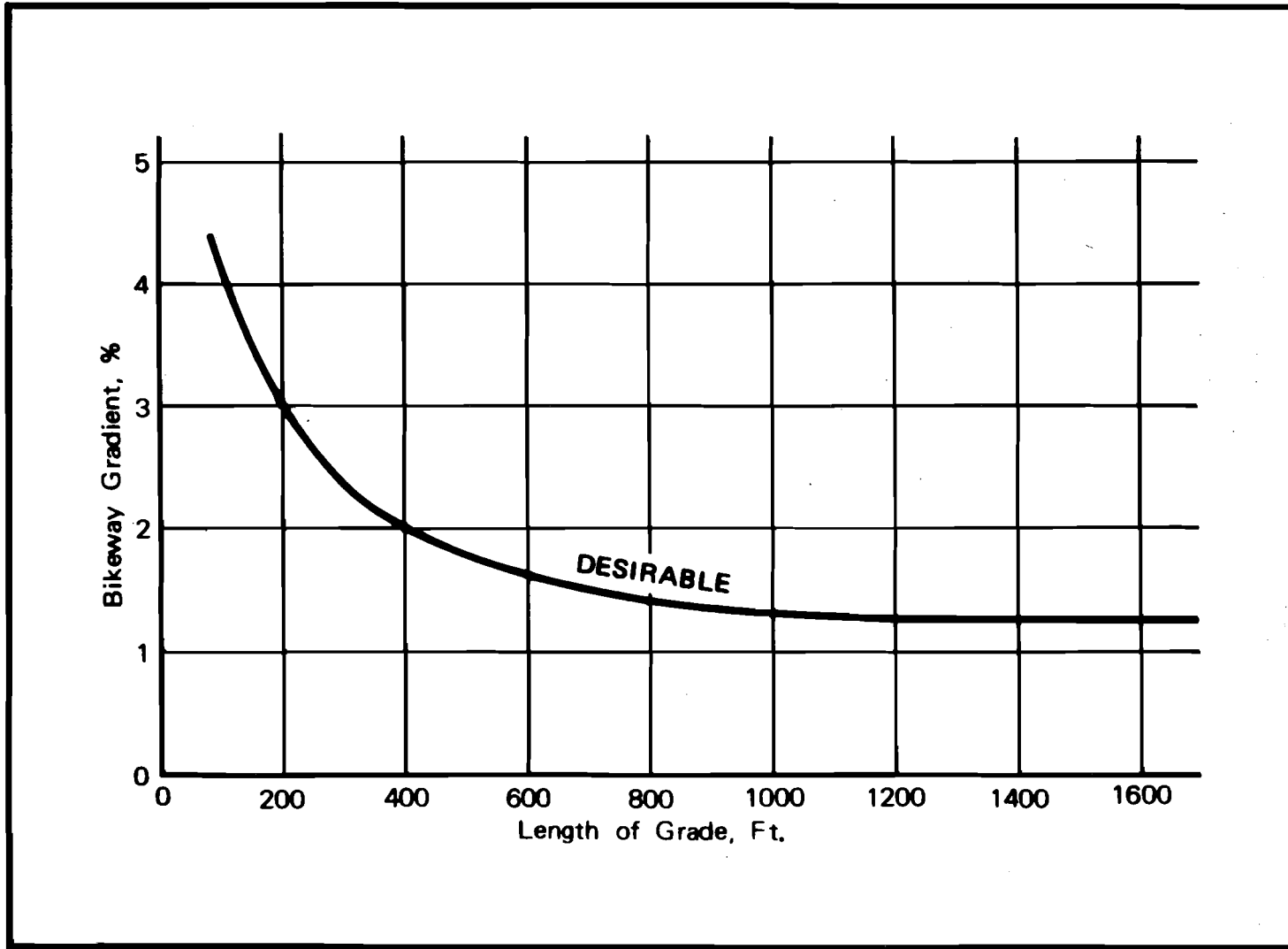

Figure VI-12 LENGTH OF DESIRABLE GRADE
SOURCE: State of Oregon, Bikeway Design

Bikeway Width and Clearances

"The width required for a bikeway is one of the primary considerations in bikeway design. Since the cost and feasibility of providing the bikeway varies with its width, it is necessary to determine minimum specifications subject to the space required for the cyclist, allowance for lateral movement between cyclists, allowance for lateral clearance to obstructions, and allowance for clearance to other hazards" (13).

A German study established design criteria which have been accepted in many communities (14). Figure VI-13 shows the basic dimensions of the bicycle and its operating space used to arrive at the desired path configuration.

Additional work done by the University of California, however, concluded that the "comfortable" shy distance between bicycles traveling abreast at 10 mph was 2.5 feet (15). By using a liberal conversion of the metric dimensions of the German study and the "comfortable" shy distance AASHTO (16) developed the table of bikeway surface widths shown in Table VI-2.

TABLE VI-2
BIKEWAY SURFACE WIDTHS

Number of lanes	Minimum width, feet	Desirable width, feet
1	3.5	4.0
2	7.0	8.0
3	10.5	12.5
4	14.0	17.0

SOURCE: AASHTO; Guide for Bicycle Routes

Adjustments to Basic Bikeway Widths

When longitudinal static obstructions or dynamic intrusions into the bikeway area are anticipated, additional width should be provided. Table VI-3 indicates the amount necessary for some typical conditions.

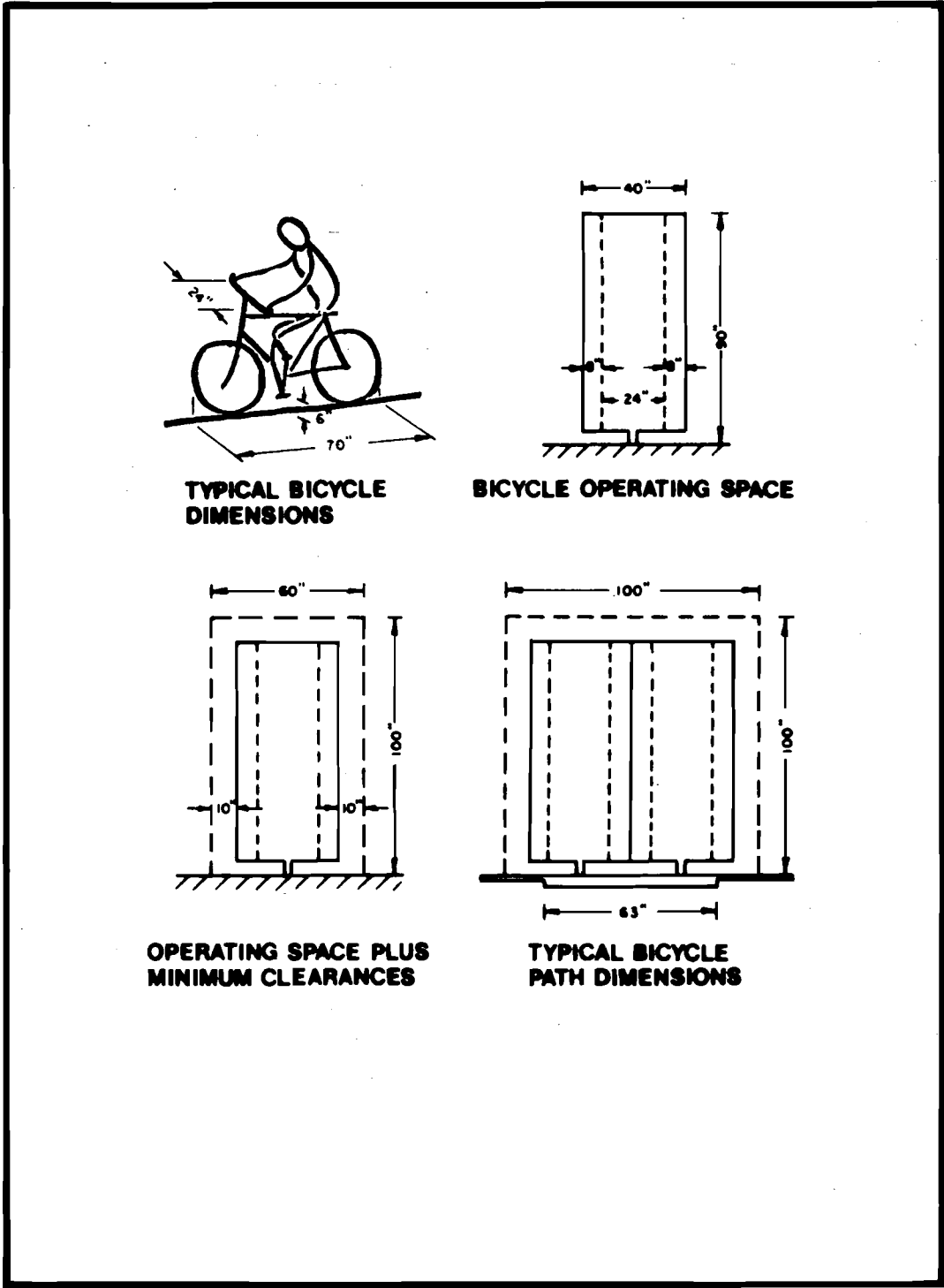

Figure VI-13 BICYCLE OPERATING SPACE
 SOURCE: U. S. Dept. of Transportation,
Bikeways-State of the Art-1974

TABLE VI-3
OBSTRUCTION CLEARANCE ALLOWANCE

Condition	Additional Width, feet	
	Minimum	Desirable
Raised curb on one side	0.5	1.5
Raised curb on both sides	1.0	2.0
Parked cars adjacent	2.0	2.0

SOURCE: AASHTO; Guide for Bicycle Routes

The following are two examples of how to use the above tables to determine bike lane widths:

1. A one-directional one-lane bikeway is to be placed on the roadway adjacent to the existing curb, parking is removed.

The minimum bike lane width is
 $3.5 + 0.5 = 4.0$ feet

If traffic buttons, curbs, raised berms, planter boxes, or raised physical margins, were to be placed between the bike lane and the moving traffic, this dimension should increase to 4.5 feet at a minimum and 6.0 feet as a desirable width.

2. A one-directional, one-lane bikeway is to be placed on the roadway between the parked motor vehicles and the moving traffic. (The parking lane is 8 feet wide).

The minimum bike lane width is
 $3.5 + 2.0 = 5.5$ feet

The distance from the curb to the farthest bikeway boundary line is 13.5 feet.

Figure VI-14 shows the minimum space requirements for a combined bicycle/pedestrian operation based on two conditions: a pedestrian "No Touch" and a "Personal Comfort" zone. Although this information provides a basis for design of a sidewalk bikeway or an independent path shared with pedestrians, it should be used cautiously. The additional three inches of space between the bicycle and pedestrian that changes the "No Touch" space to a "Personal Comfort" zone does not appear to be in keeping with the close proximity of a bicycle passing at 10 to 15 mph. Also, the horizontal space needed by a child would probably exceed that of an adult.

Capacity

The capacity of a bikeway is a function of its lane width (Figure VI-15). In most cases a bikeway with dimensions meeting the above standards will have capacity far exceeding that required. However, in areas where peak period demands exceed the existing or proposed bicycle facility's limits, it may be preferable to increase the number of lanes to minimize collisions caused by crowding (17).

Cross Sectional Criteria

The minimum roadway width in which a bikeway can be placed without structural alteration to the roadway is a function of the required motor vehicle travel lane widths, the number of lanes required, the demand for on-street motor vehicle parking space, and the predicted bicycle volume.

The basic minimum motor vehicle travel lane widths are given in Table VI-4:

TABLE VI-4
MINIMUM MOTOR VEHICLE TRAVEL LANE WIDTHS

Roadway Type	Width, feet
Expressway	12
Arterial	11*
Collector	
Single Family	10
Other	11
Local	
Single Family Residential	10
Other	11

SOURCE: Traffic Engineering Handbook

* Ten foot minimum is satisfactory on tangent horizontal alignment when curbs and buttons are not present.

An allowance of 8 feet should be made for a parking lane.

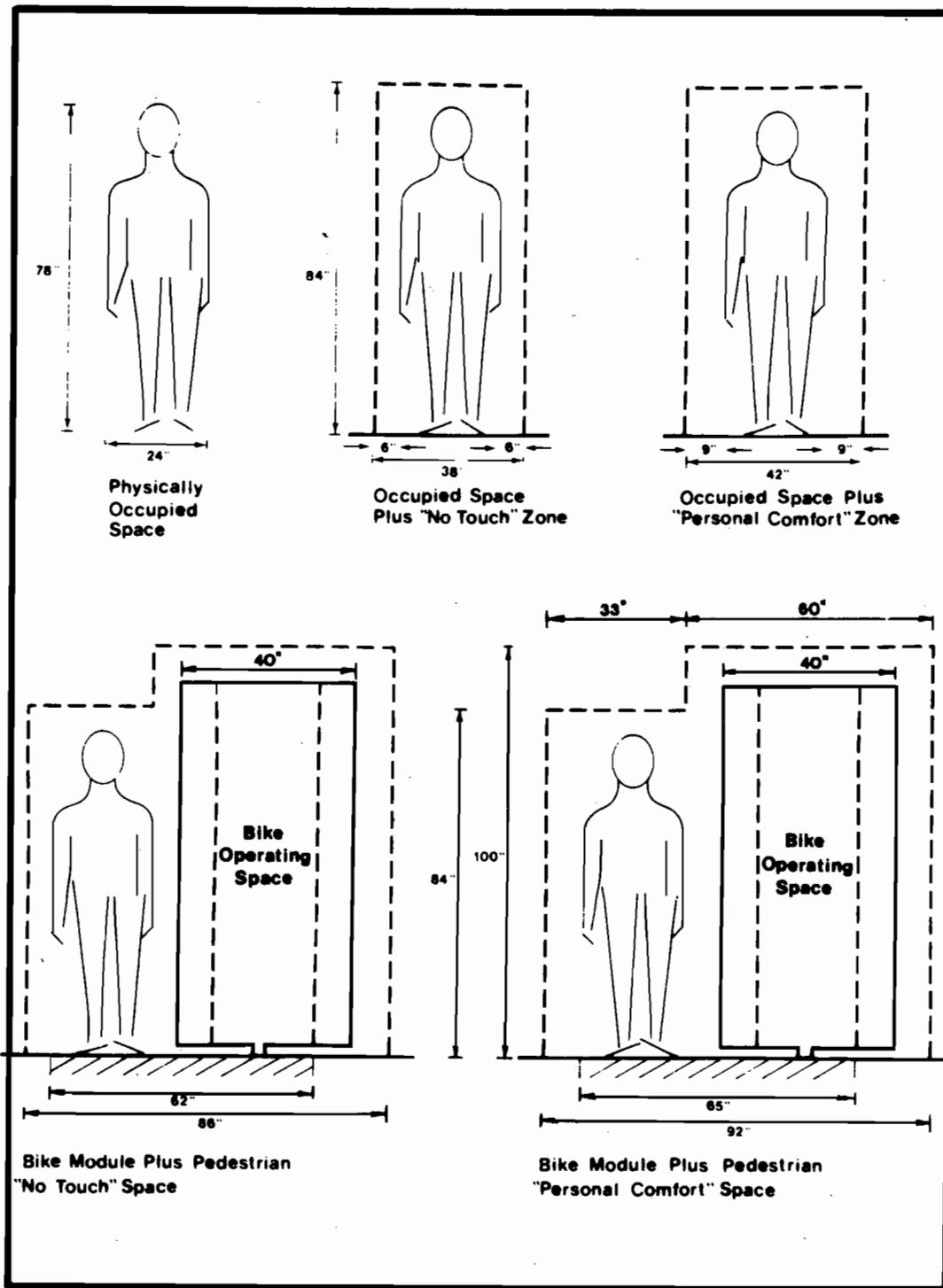

Figure VI-14 BIKE-PEDESTRIAN SPACE REQUIREMENTS

SOURCE: U. S. Dept. of Transportation,
Bikeways-State of the Art-1974

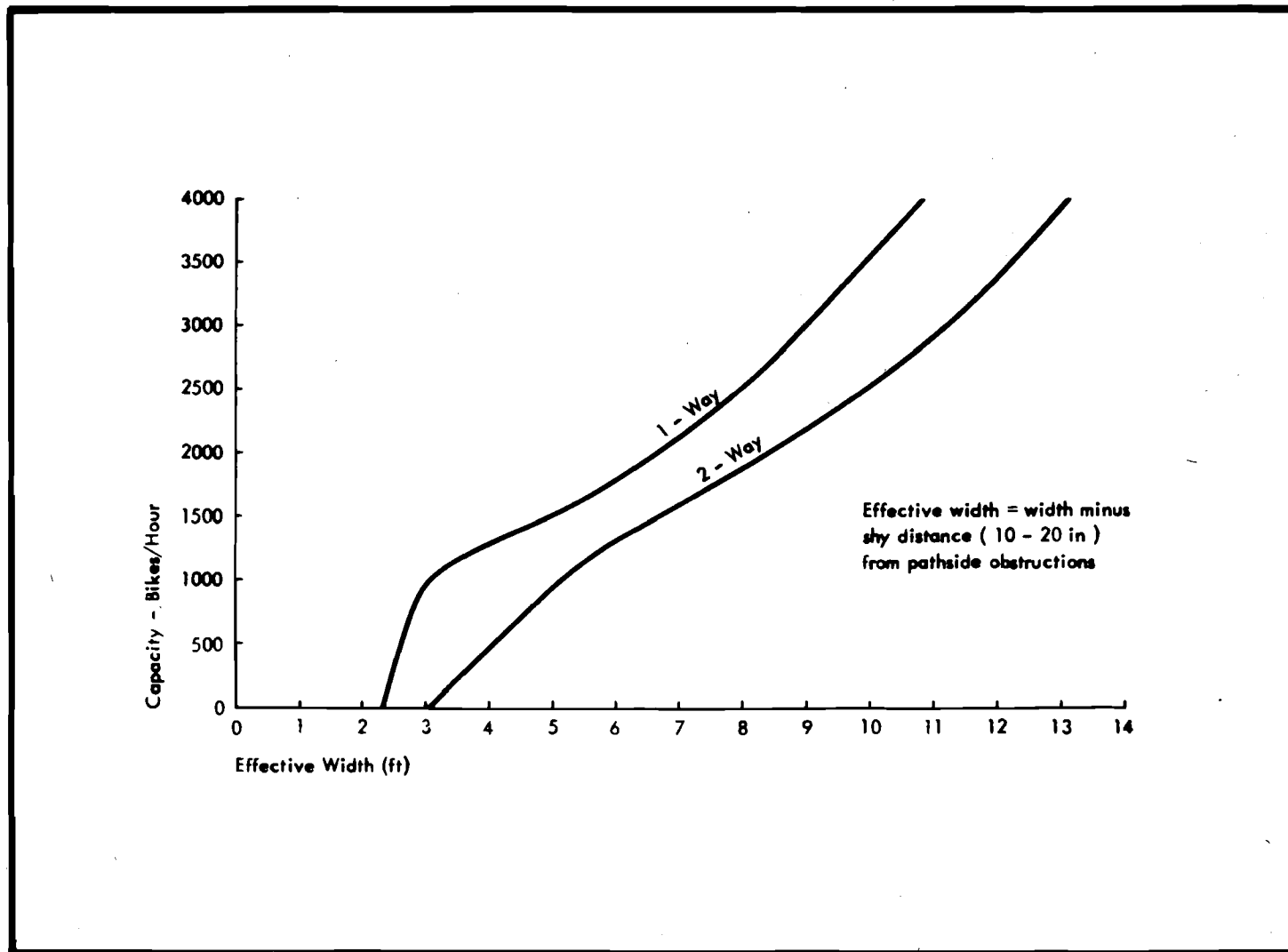

Figure VI-15 BICYCLE LANE AND PATH CAPACITY

SOURCE: Deleuw, Cather & Co., Davis Bicycle Circulation & Safety Study

The cross sections shown in the following illustrations are some possible roadway configurations incorporating Bike Lanes.

Figures VI-16 and VI-17 depict various usable arrangements on standard width roadways; some require parking to be removed, others are for one-way motor traffic, while still others necessitate a two-directional Bike Lane. This is not the total range of on-street possibilities because of the large diversity of roadway widths and the ability, in some cases, to widen the pavement or to use the sidewalk for one directional movement.

A physical barrier is shown on the figures separating the two directional bicycles from the adjacent moving motor vehicle traffic. This is not required where both bicycles and motor vehicles are moving in the same direction.

BIKEWAY STRUCTURE

When a bikeway is incorporated within an existing roadway or sidewalk, the structural strength of the pavement is more than adequate for bicycle traffic. However, if the sidewalk or roadway is to be widened or a bicycle path constructed, the new structure must meet the load requirements of motor vehicles which may cross or use the facility. Occasionally, a bicycle path can also serve as an access road for emergency vehicles.

The construction methods and materials used for a bicycle path are, in general, similar to those used for roadways. A sub-base is prepared by clearing and removing the top soil and debris before compacting. Where necessary, proper materials (crushed stone, slag, etc.) should be added to the sub-base for stabilization. Local conditions will dictate the requirements of the construction details.

The base course distributes the load from the wearing surface to the sub-base. Materials that can be used for the base course are gravel, crushed stone, slag, stabilized earth, soil cement, asphaltic concrete, and portland cement concrete (18, 19). Figure VI-18 shows some typical structural sections for bicycle paths.

The surface material should provide a stable bicycling path even when wet. Materials that shift under load or do not provide lateral stability, like coarse graded crushed stone, gravel or sand, are undesirable. The finished pavement surface should provide a dense texture to aid path cleaning (e.g., removing glass splinters and, in some areas, thorns). Care must be exercised not to create a surface which becomes slick when wet. It should also be as even as possible to provide a comfortable ride for bicyclists at the design speed.

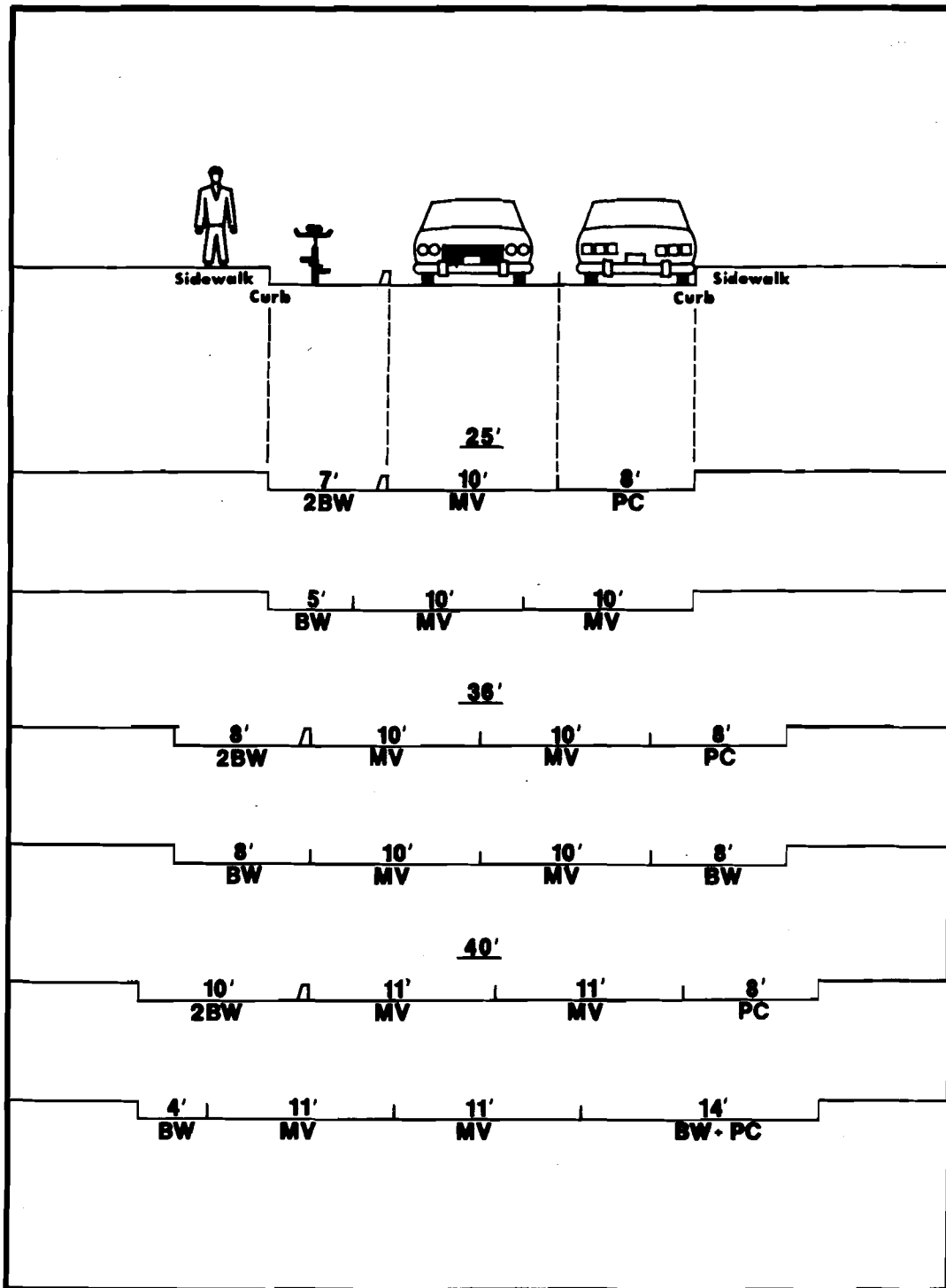

Figure VI-16 STANDARD ROADWAY CONFIGURATIONS

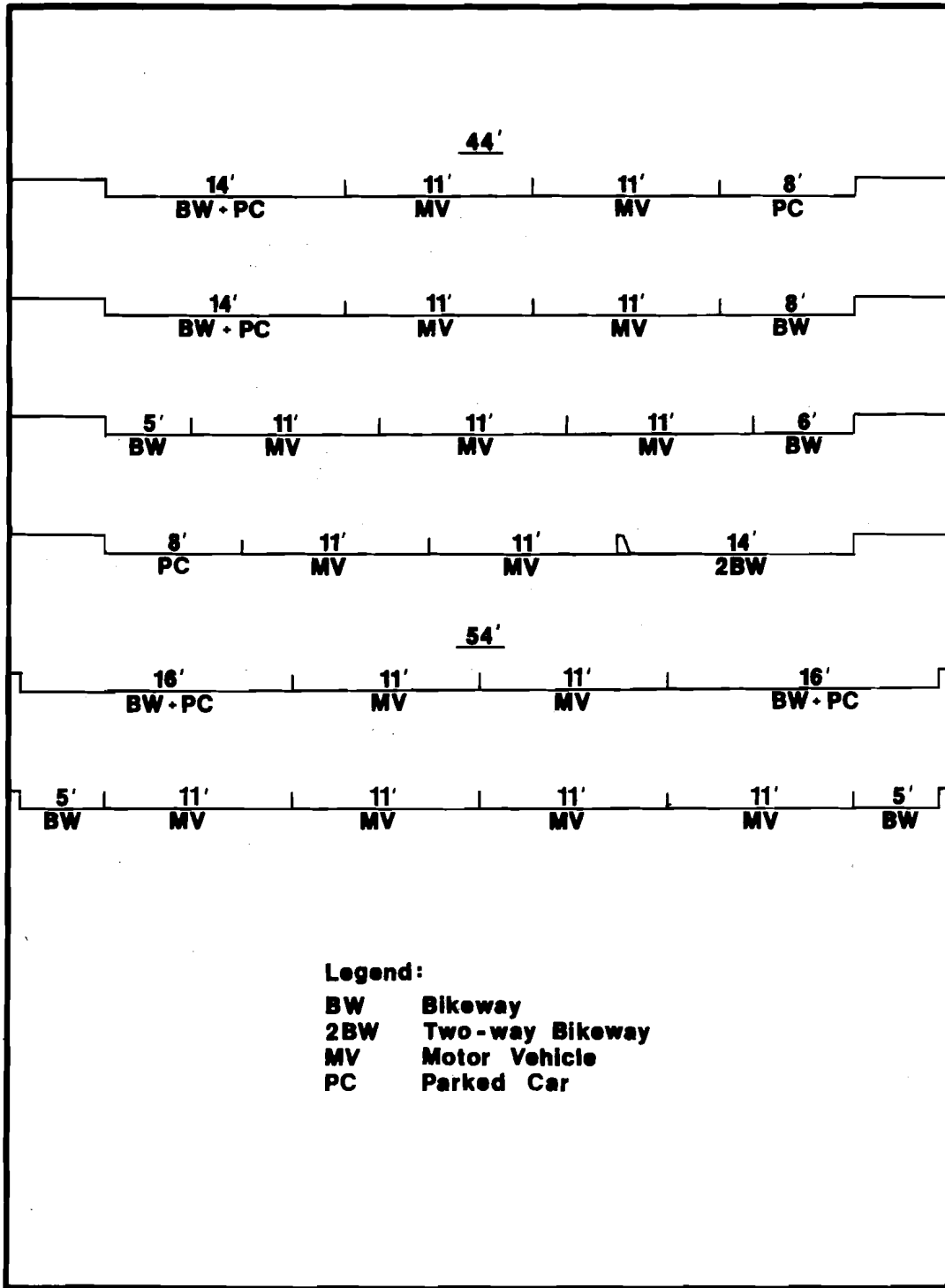
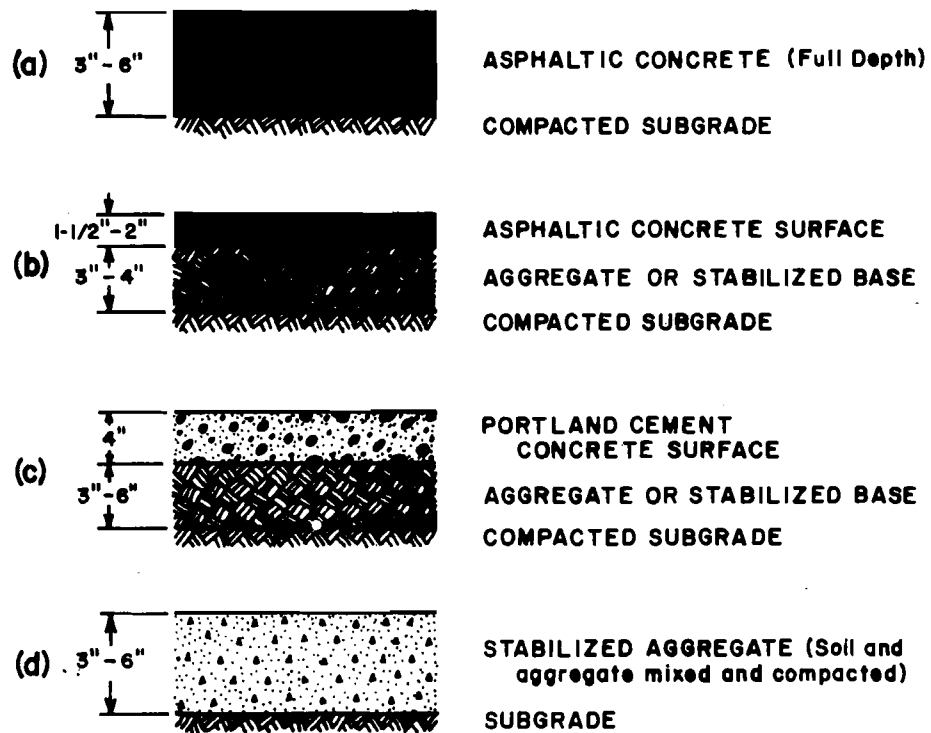

Figure VI-17 STANDARD ROADWAY CONFIGURATIONS



Typical Pavement Structural Sections
for Bicycle Trails

Figure VI-18 TYPICAL STRUCTURAL SECTIONS FOR
BIKEWAY PATHS

SOURCE: American Assoc. of State Highway &
Transportation Officials, Guide for
Bicycle Routes

Metal and wood edging strips have been used to keep the pavement from chipping or raveling. A backfill of dirt, sod, sand, barkdust, or crushed rock has served this purpose on some bikeways. Care should be taken when using an edging strip that it be flush or below the pavement surface so as not to present a hazard to the inattentive bicyclist. Use of coarse rock, gravel, or sand as a backfill material is not recommended.

In order to minimize dirt and debris collection on the Bike Path surface, wherever possible, the path structure should be elevated above the adjacent ground. Figure VI-19 illustrates one method that has been used successfully in Seattle, Washington. The asphalt edge shim provides convenient access to and from the path at all points in addition to eliminating the hazard created by an abrupt edge.

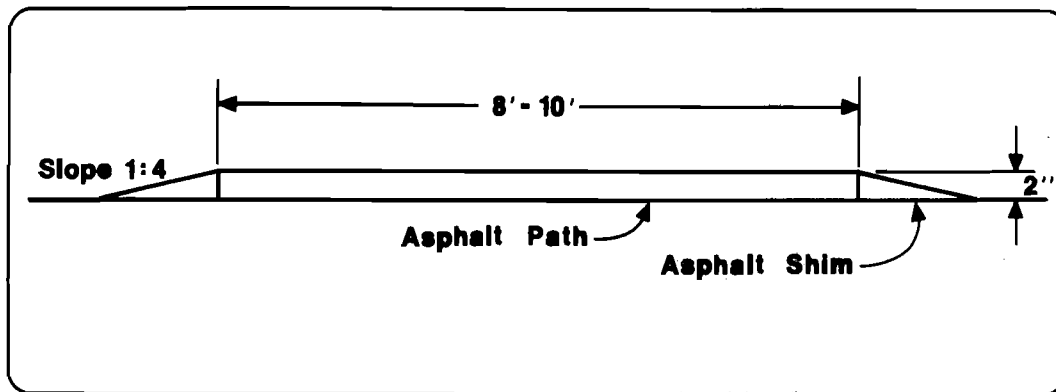

Figure VI-19 ELEVATED PATH

DRAINAGE

Bikeways must be designed with adequate provisions for drainage of water from the riding surface and, in the case of separate paths, from along side and under the riding surface. The Bike Path should be graded to a crown at the center of the paved surface or superelevation provided to assure drainage. A crown of four percent cross slope (20) or a superelevation of two percent (21) is recommended. If minor surface cross drainage is anticipated a smooth short dip is preferable to either an extensive sheet of water or an abrupt valley.

Bikeways contemplated for existing streets or sidewalk locations will, in general, have a sufficient drainage system. However, a number of drainage considerations must be made regarding on-street bikeway locations. The commonly used parallel bar inlet grate can permit many types of bicycle wheels to drop into the slots. Where the slot is long, the wheel can be trapped, causing the bicycle operator to upset; shorter slots can cause damage to the bicycle wheel rim and possibly loss of control. A common practice of welding or bolting cross bars to eliminate this problem is, at best, a palliative. Unless the crossbars are placed close together, (at about six inch intervals), the entrapment potential remains. The use of cross strips reduces

the hydraulic efficiency of the inlet and should be evaluated for adverse storm drainage impacts.

Painted or plastic warning stripes around the inlet grate or a shear line for approaching bicyclists (Figure VI-20) should be considered. Painting the entire inlet grate will enhance its visibility.

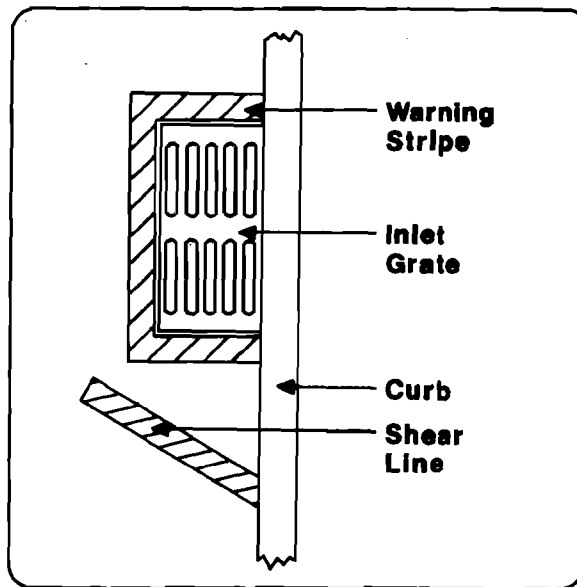

Figure VI-20 INLET GRATE WARNING STRIPES

NOTE: The Federal Highway Administration is presently conducting tests on fifteen "bicycle safe" inlet grates (June, 1975). The results, will presumably produce replacement grate designs with acceptable hydraulic characteristics.

Another condition associated with inlet grates that the bikeway designer must consider is the possible mismatch in elevation between the surrounding roadway surface and that of the inlet grate surface. In some cases this is the result of the roadway being resurfaced and the grate remaining at the original elevation. However, some drainage grate designs require this arrangement to achieve hydraulic efficiency. Where funds do not permit inlet modification for the bicyclist's benefit, the painted warning may be the only acceptable solution.

The potential bikeway location should be inspected when water is on the roadway surface to check for puddles. Large amounts of standing water may cause bicyclists to decide to ride into the motor vehicle traffic stream. Additional drainage inlets or minor resurfacing may be necessary to correct this problem.

The paved Bike Path construction is very similar to that of a road and requires proper drainage facilities. Water must not be allowed to stand in puddles along side of the path which could cause heaving during winter or be a breeding ground for mosquitos during the summer.

Surface water runoff from the adjacent land should be collected in a ditch and carried off to reduce the possibility of path washout. A ditch may, however, constitute a hazard to bikeway users. In very wet areas a causeway may be more appropriate than a surface bikeway; when crossing usually dry stream beds a bridge or culvert can be used to elevate the bikeway. Where the bike path is exposed to occasional flooding water, as along a river that carries spring runoff, the replacement of the facility may be more economical than building a bridge or dike.

INTERSECTIONS AND CROSSINGS

Possibly the most important area within the total scope of bikeway design, relating to bicycle safety, is that of providing "interference free" movement of bicycles, pedestrians and motor vehicles through intersections. The extent to which channelization and control devices can be used toward achieving this goal is the subject of this section. The bikeway design considerations for railroad crossings are also addressed.

The range of bikeway intersection situations includes: 1) on-street Bike Lanes or Bike Street arrangements and their crossing or turning on to Bike Paths, Sidewalk Paths or other roadways (Figure VI-21); 2) Sidewalk Paths crossing or joining a roadway or Bike Path (Figure VI-22); 3) and a Bike Path crossing or joining a Sidewalk Path or roadway (Figure VI-23). Whether two-directional bicycle flow is encouraged on any designated bikeway, the results of two-way movement should be analyzed. The elimination of two-way use, even when expressly forbidden, may be difficult to enforce on Bike Paths and Sidewalk Paths. Because of the complexity and numerous variations of intersection arrangements, the following descriptions will provide a conceptual approach to solution of these problems. The detailed resolution of individual intersection situations will be left for the bikeway designer.

On-Street Bikeway

Figure VI-24 shows possible points of conflict between bicycles and motor vehicles legally passing through or turning in a street intersection. A variety of typical bicycle left-turn maneuvers is shown in Figure VI-25 to demonstrate the complexity of resolving a bikeway turn situation. The path used by the bicyclist will depend, to a large extent, on the motor vehicle volume and speed, the number of lanes of traffic to be crossed, and the experience, audacity or adherence to local regulations of the bicycle operator.

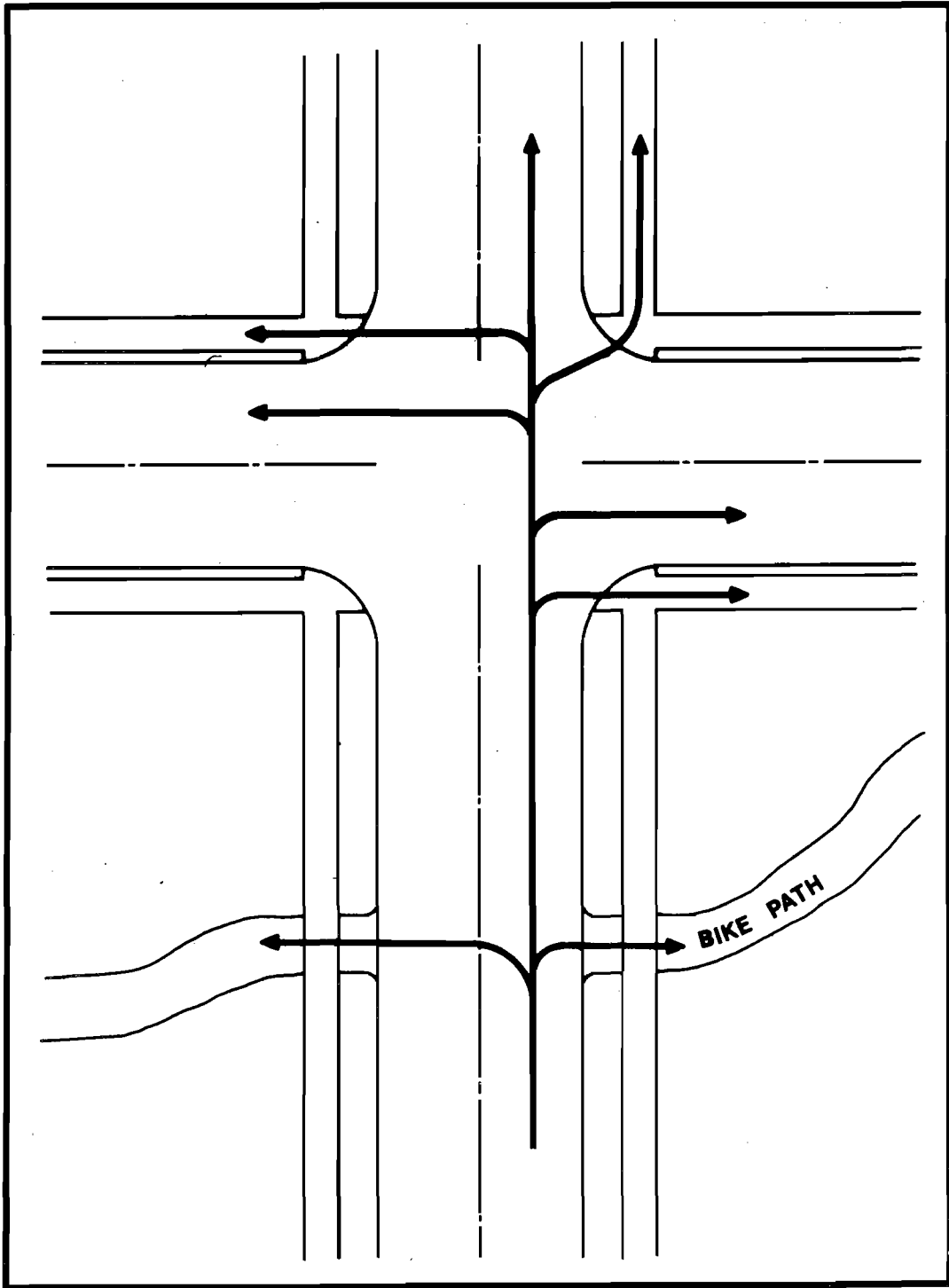

Figure VI-21 ONSTREET BIKEWAY-TYPICAL INTERSECTIONS

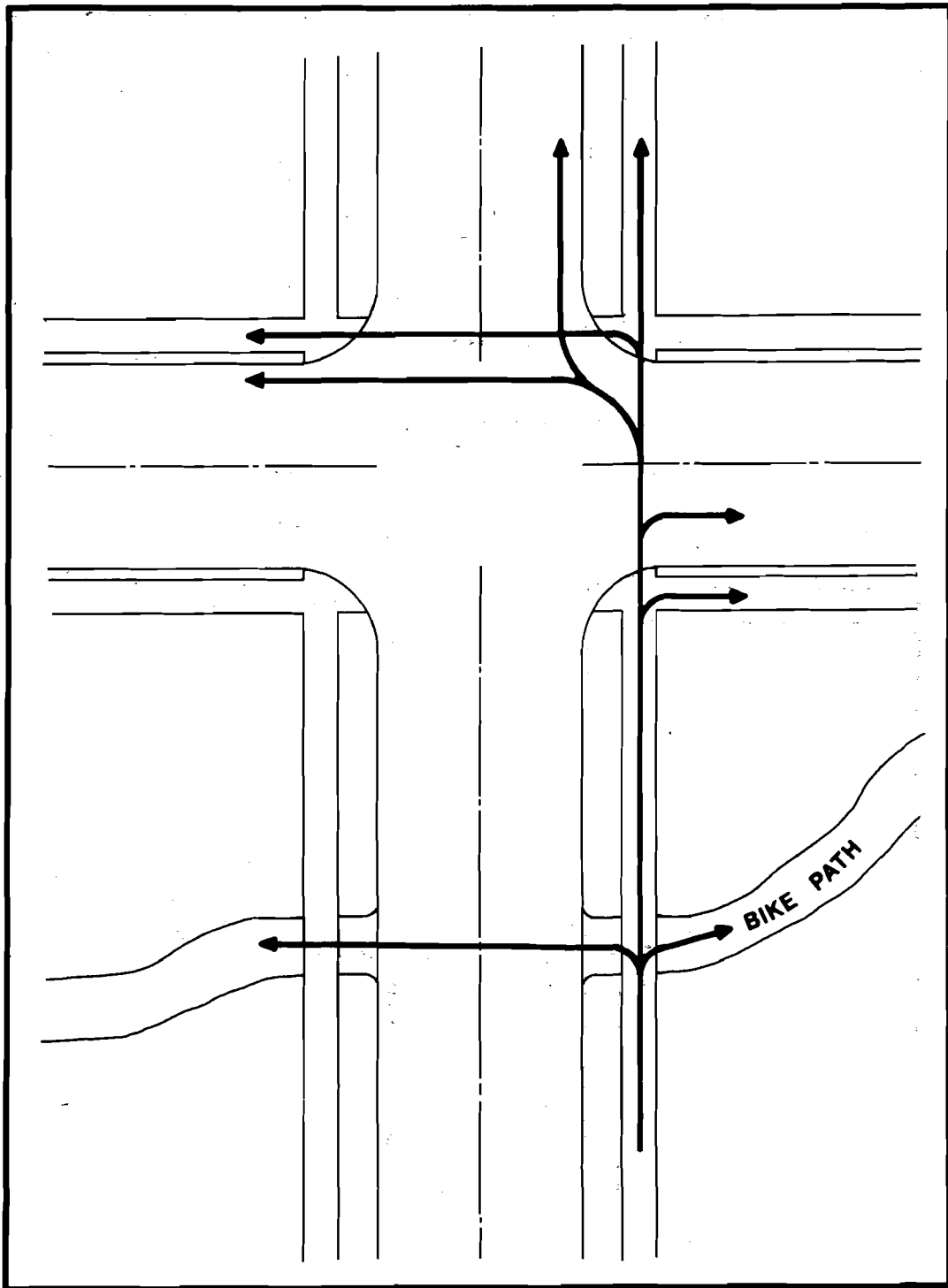

Figure VI-22 SIDEWALK BIKEWAY-TYPICAL INTERSECTIONS

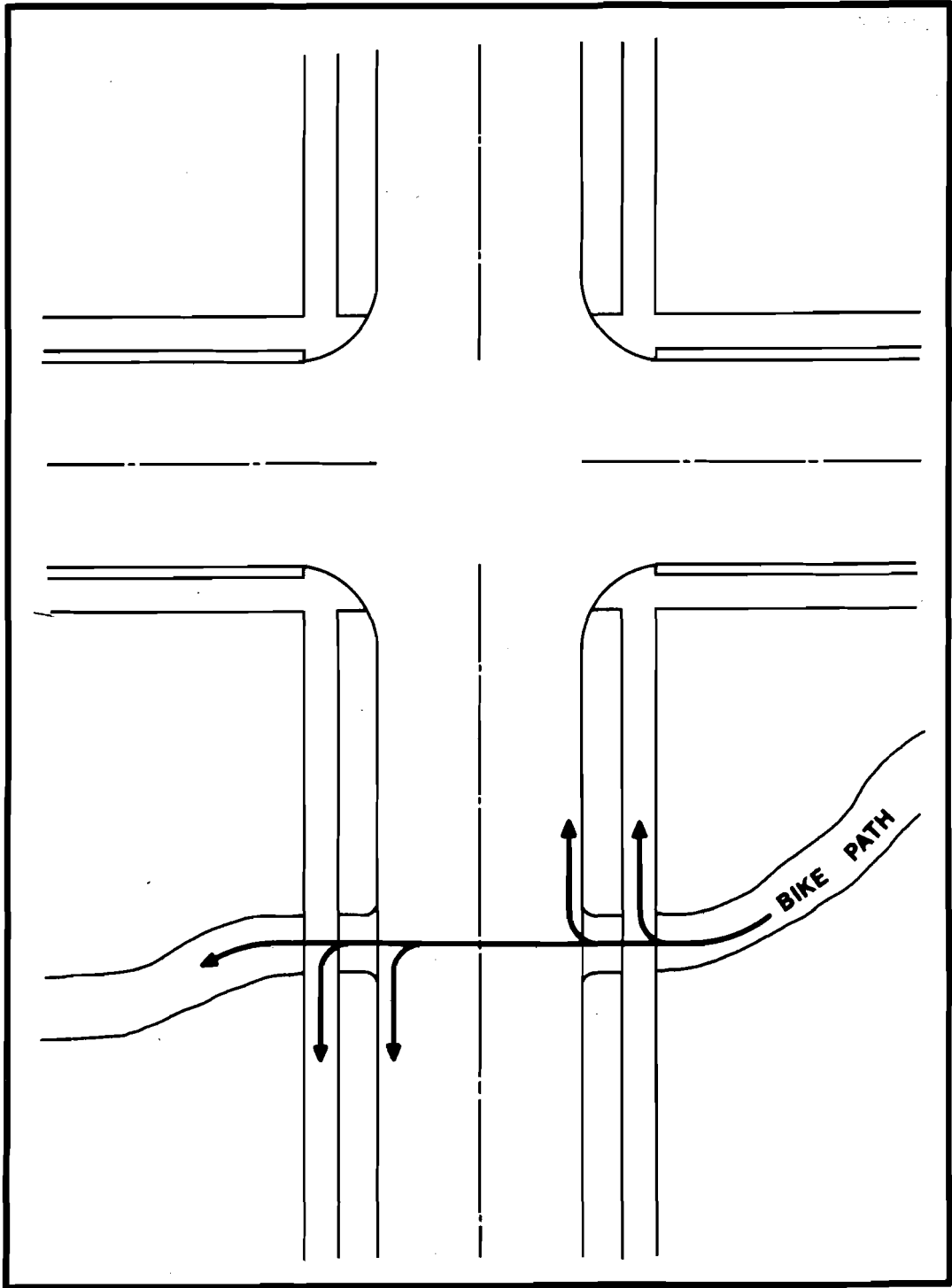

Figure VI-23 BIKE PATH-TYPICAL INTERSECTIONS

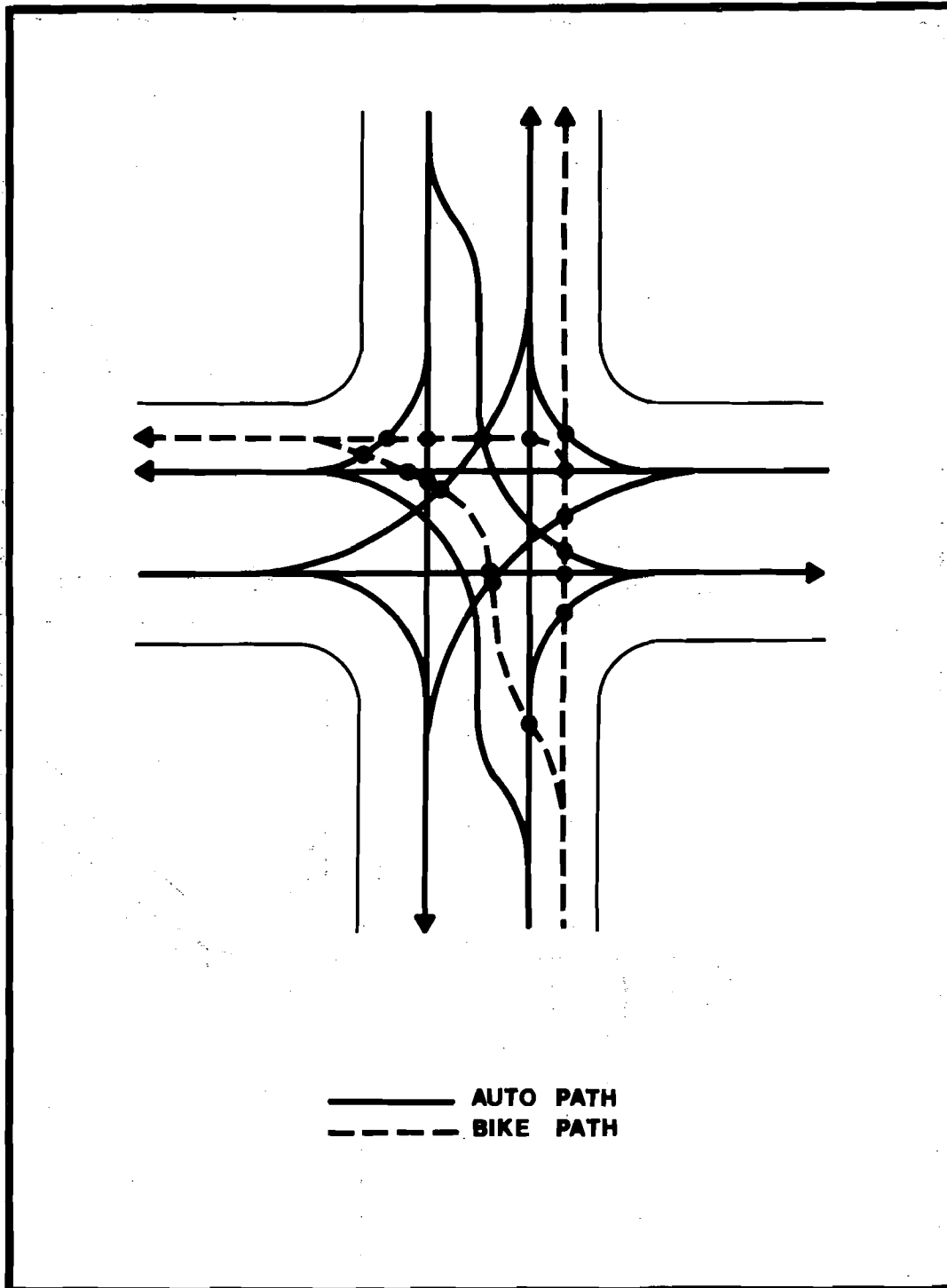

Figure VI-24 POTENTIAL POINTS OF CONFLICT
 SOURCE: Deleuw, Cather & Co., Davis Bicycle
 Circulation & Safety Study (21)

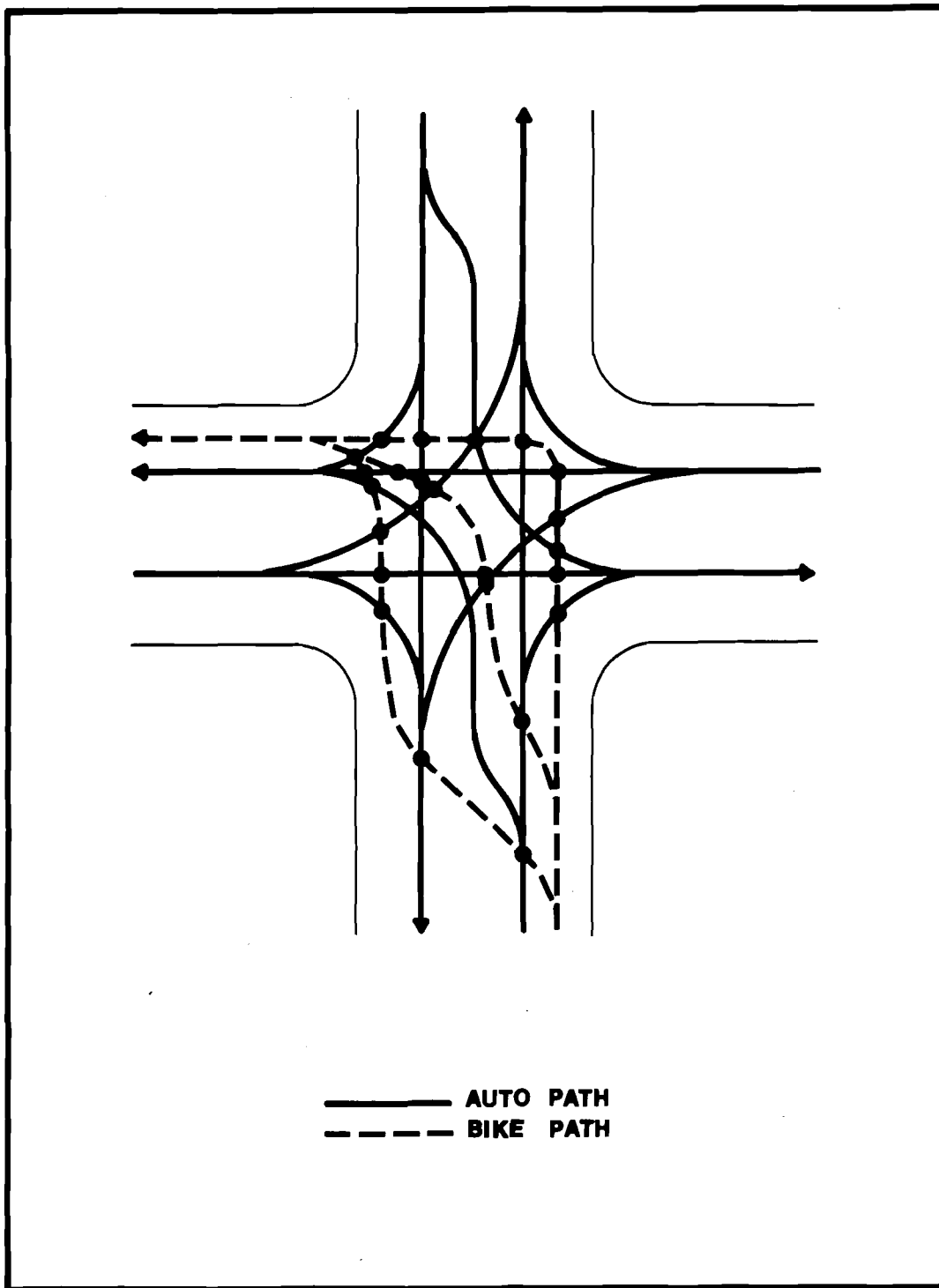

Figure VI-25 TYPICAL LEGAL /ILLEGAL BICYCLE
LEFT TURN MANEUVERS

SOURCE: Deleuw, Cather & Co., Davis Bicycle
Circulation & Safety Study

The bicyclist passing through the intersection must contend with the conflict caused by left turning motorists who are unaware of his presence or who misjudge the ability of both to avoid a collision. The overall category of "Did not grant right-of-way" is the most significant cause of motorists caused bicycle/motor vehicle accidents (23). All bicyclists following the "keep right" rule face the possibility of conflict from right turning motor vehicles approaching a street intersection from the same direction. The motorist's attention is usually directed to the pedestrians and motor vehicles entering the crossing and may tend to ignore the bicycle to his right. Most automobile designs provide only limited visibility to the right rear.

The channelization schemes shown in Figures VI-26 and VI-27 permit all users of the roadway to be advantageously positioned prior to entering the intersection. Both methods assume that the bicyclist not wishing to proceed in the direction of the bikeway would revert to the "keep right" rule. (Most communities in the United States require bicyclists to operate as far to the right of the roadway as is practicable except where a designate facility is provided.

Applications similar to these two techniques have been installed in Seattle, Washington, and Davis, California. The bikeway intersection design in Seattle (like Figure VI-26 except from the left lane on a divided roadway) has proven to function very efficiently in a moderately high traffic volume situation.

Figure VI-28 shows a European design that provides separate bicycle and motor vehicle lanes for all possible intersection maneuvers.

All of these methods require weaving of motor vehicles and bicycles as they move into the prescribed approach lane position. When a new bikeway concept is being introduced in a community an educational campaign should be conducted. This effort should include law enforcement agency assistance, publicity through the news media and temporary informational signs along the facility.

Two intersection treatments commonly used in the United States are shown in Figure VI-29. Delineating the Bike Lane through the intersection has been used to warn approaching motorists of a bikeway crossing and, in some cases, to contain the bicyclists within a prescribed path through the intersection. The use of a unique paint color has also been employed by some jurisdictions to increase motorists' awareness of the bicycle facility. This technique is covered in more detail in the section on Signs and Markings.

Figure VI-29 also shows two methods of controlling right-turn motor vehicle activity. (The use or nonuse of bikeway boundary lines in the intersection has no bearing on how motorists are controlled). The motorist in the upper diagram is restricted by regulatory signs or a curbing from encroaching into the bikeway. On entering the intersection, the motorist must yield to any bicycle approaching from the right rear in addition to being aware of all other pedestrian and motor vehicle activity within or approaching the intersection from the three other directions.

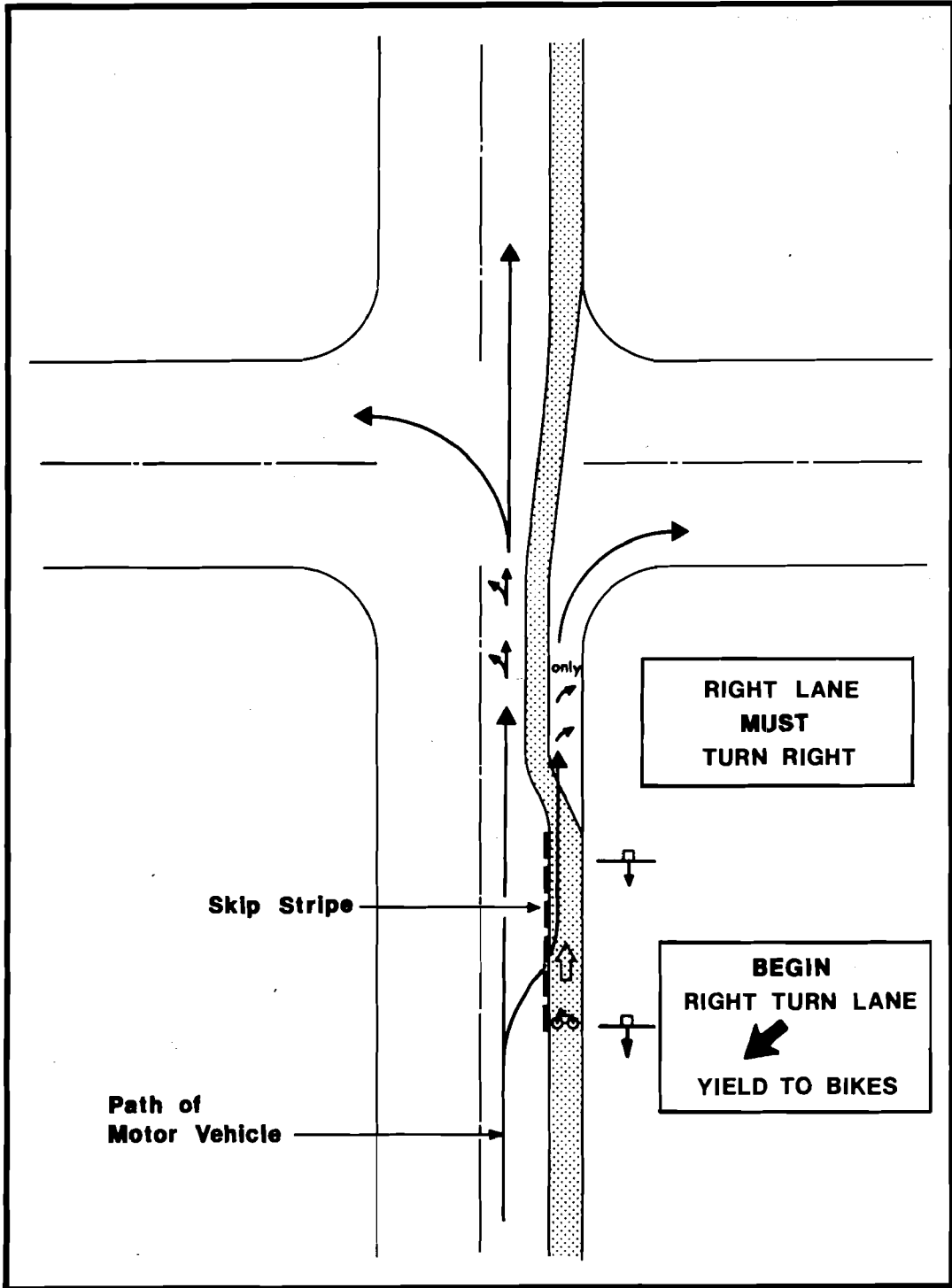

Figure VI-26 INTERSECTION CHANNELIZATION-THRU BIKEWAY

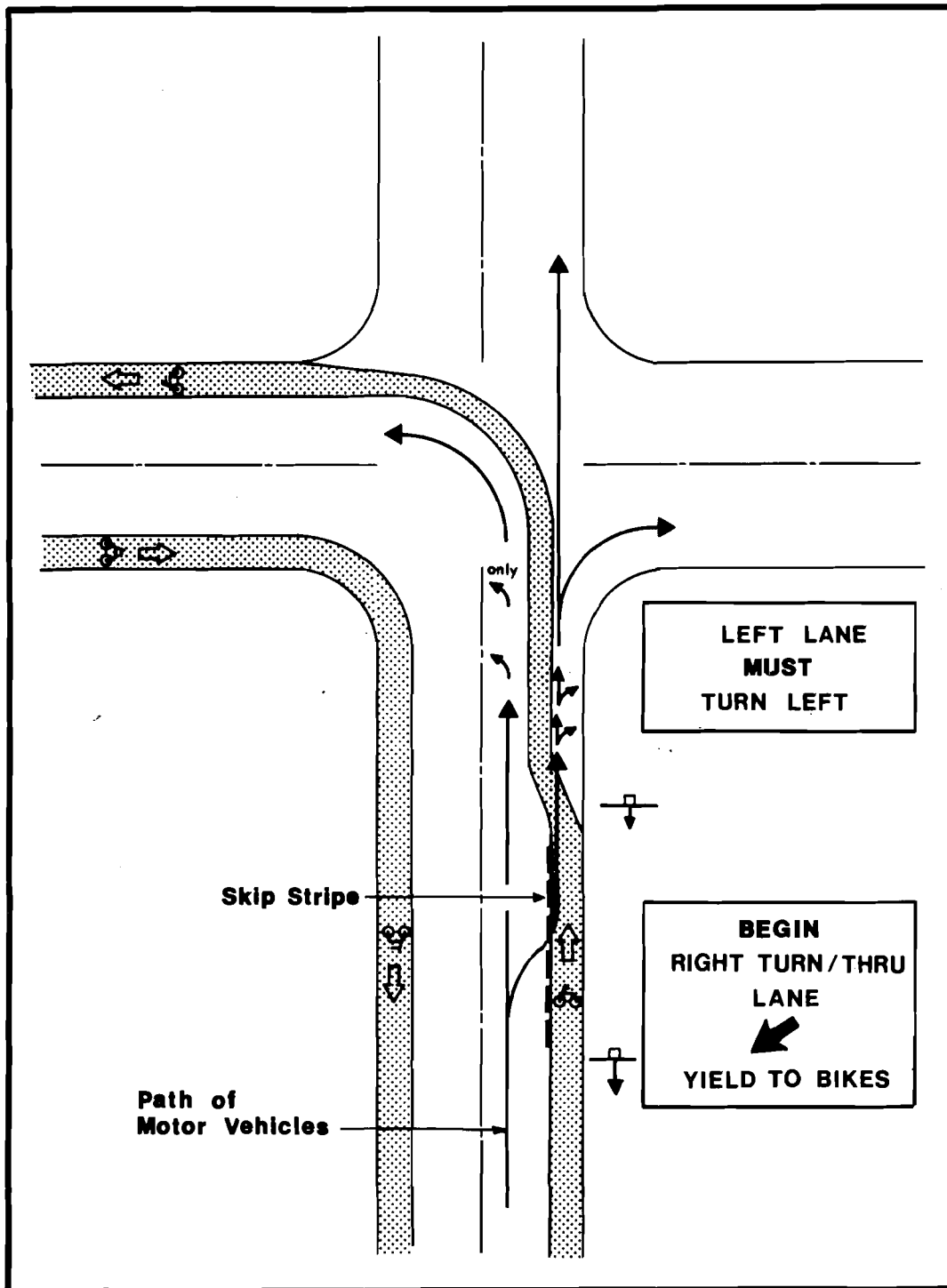

Figure VI-27 INTERSECTION CHANNELIZATION-
BIKEWAY LEFT TURN

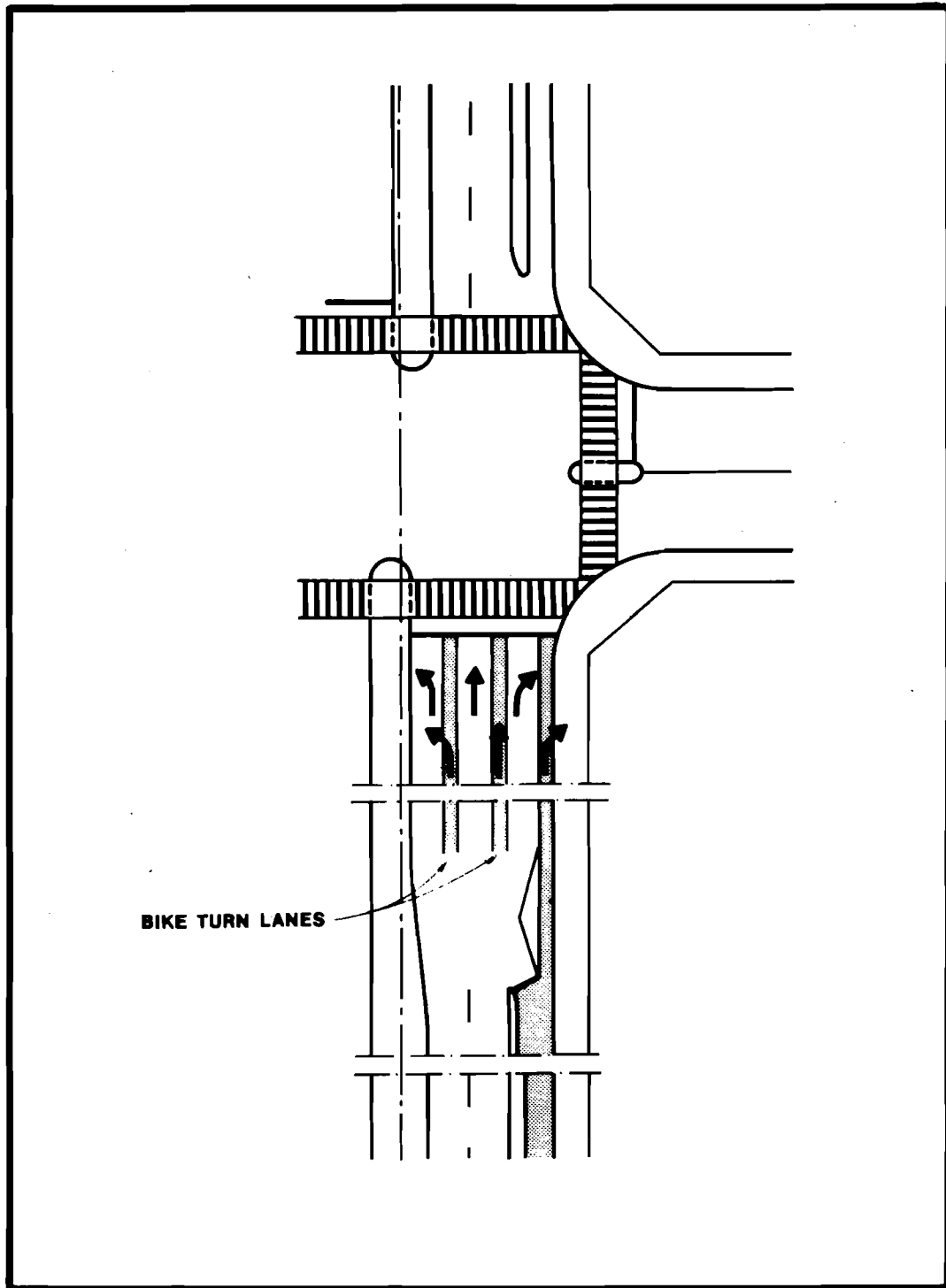

Figure VI-28 BICYCLE INTERSECTION APPROACH LANES

SOURCE: U. S. Dept. of Transportation,
Bikeways-State of the Art-1974

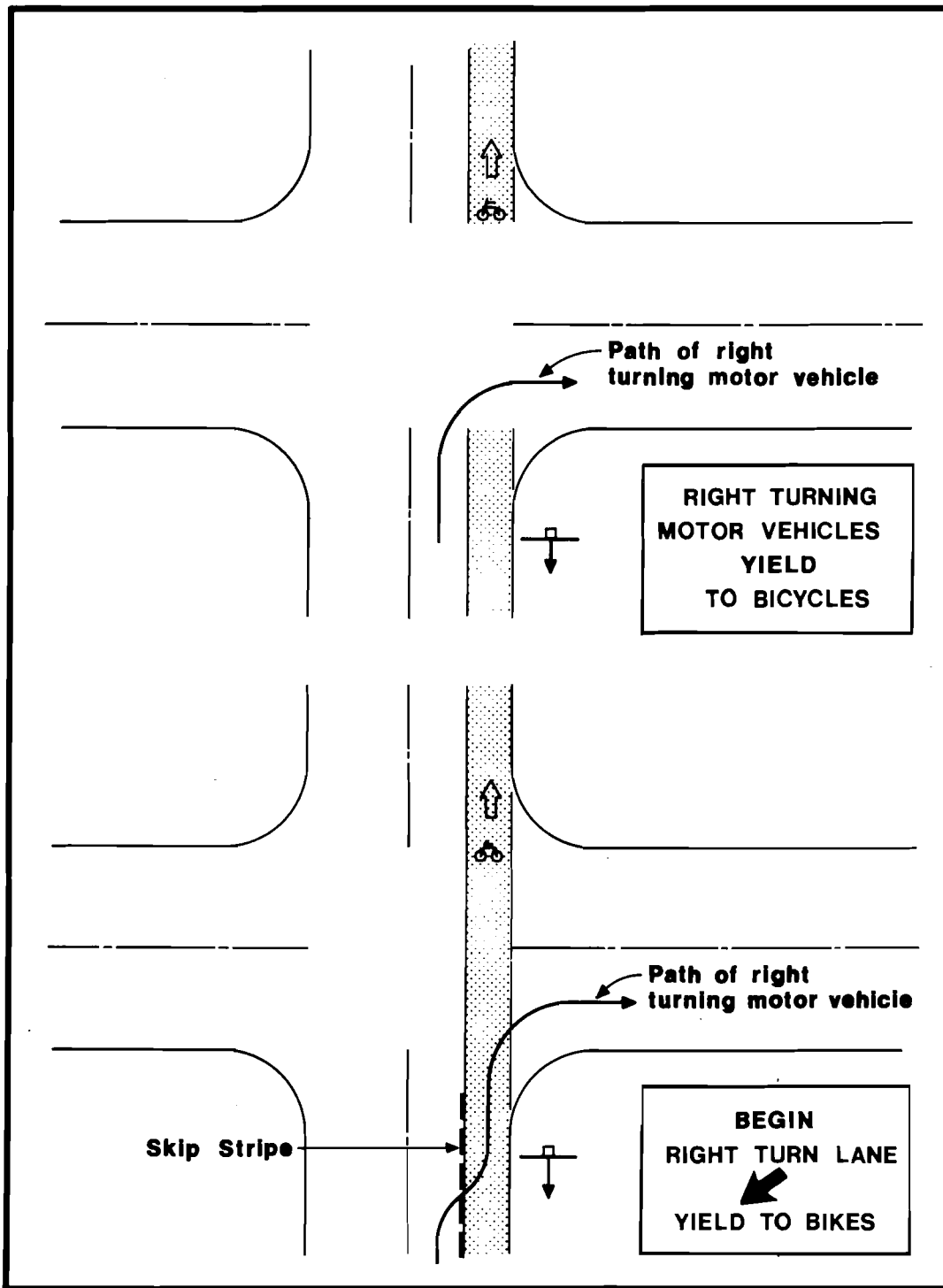

Figure VI-29 CONTROL METHODS-TURNING MOTOR VEHICLES

The motorists' intersection activity is simplified somewhat by the technique described in the lower diagram. Motor vehicles are required by regulation to enter into the bikeway at a point prior to arriving at the intersection. While entering, and when in the bikeway, the motorist must yield the right of way to the bicycle. The advantage of this approach is that it permits the motorist and bicyclist to resolve their merging conflict prior to becoming involved in the potential conflicts at the intersection and allows all of the motorist's attention to be directed toward execution of the right turn maneuver.

Bicycles exiting the street to the right onto Bike Paths and sidewalks can be conflict with pedestrians or other bicycles. Turns to the left from the roadway onto Bike Paths also have vehicle conflicts and can be especially hazardous unless traffic volumes and speeds are very low and sight distance generous. Unless these conditions can be met, the bicyclists should be directed by signing and channelization to stop on the right of the roadway prior to crossing. Where space permits, a connecting path from the Bike Lane to the Bike Path can alleviate the hazard (Figure VI-30).

Sidewalk Path

The major problem associated with the designation of the sidewalk as a bikeway (other than the obvious, and potentially serious, conflict with pedestrians) is providing safe crossing of streets, alleys, driveways and other motor vehicle access points.

Motorists expect these crossings to be occupied by pedestrians at their low speeds rather than by bicycles at speeds approaching those of motor vehicles. In addition, shrubs, buildings, parked cars and utility facilities can restrict the sight clearances of motorists' and bicyclists'. Where curb ramping is used to facilitate bicycle movement, the bicycle speed on entering an intersection can be high. The lack of ramps or ramps with a substantial lip to control entering speed may discourage use of the sidewalk facility.

A sidewalk bikeway which explicitly allows two-way operations has the same problems as a two-way Bike Lane, noted in the previous section entitled Location.

Where bicycles are directed to use the sidewalk, signs requiring them to yield to pedestrians should be considered. At all conflict points where sight clearances are limited or where motor vehicle speeds are high, motorists should be alerted by warning signs of bicycle crossings. This is necessary whether or not the bicycle operator is required to stop.

Figure VI-31 shows three methods for a transition from a Sidewalk Path to a Bike Lane at street intersection. Sketch 1 has a row of traffic control buttons strategically placed to fend off motorists who inadvertently attempt to enter the Bike Lane. Additional guidance to straight through motor vehicles is shown in Sketch 2. Bicyclists' safety could be enhanced by also providing a row of traffic control

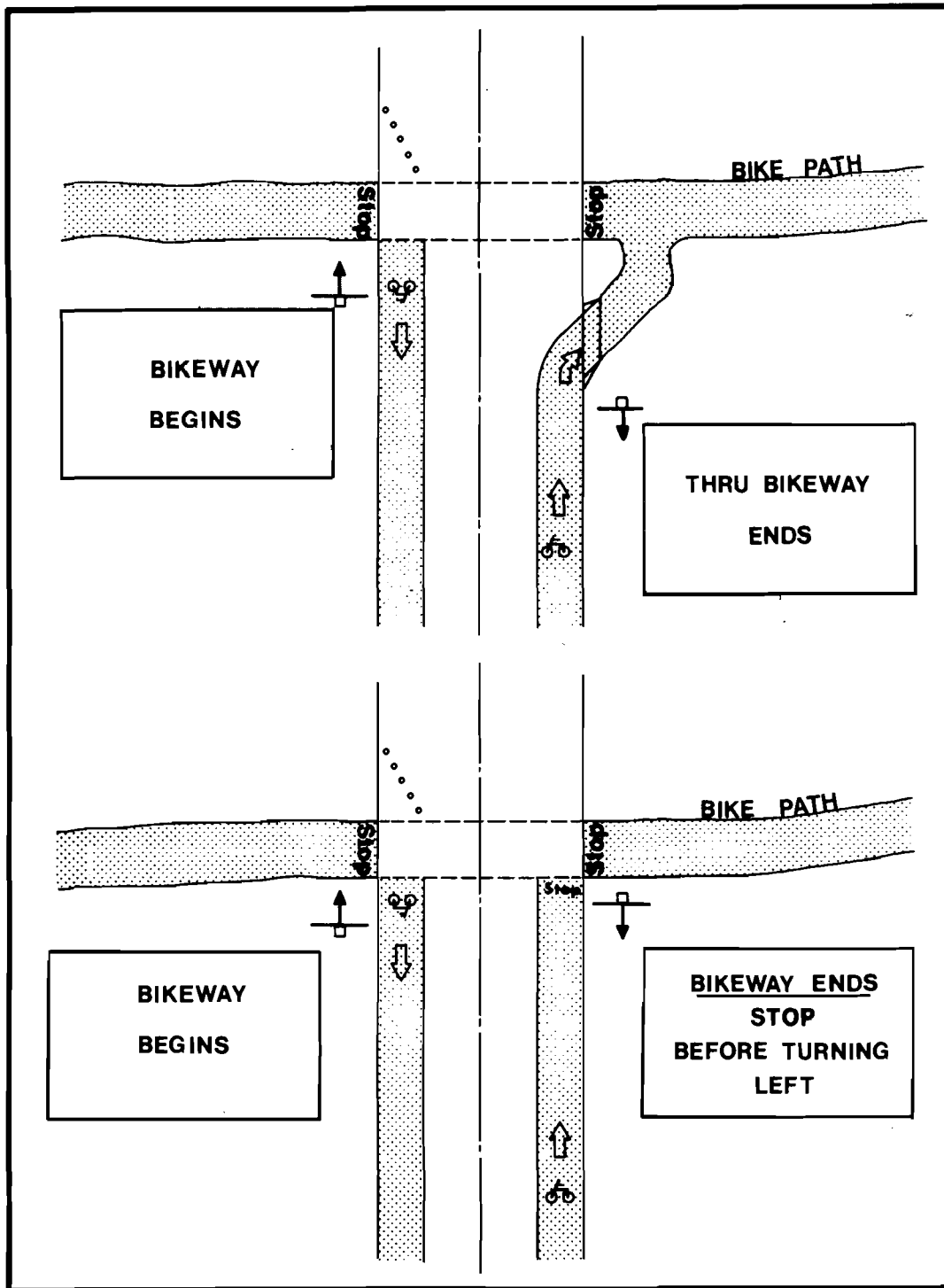

Figure VI-30 BIKE LANES/BIKE PATH TRANSITIONS

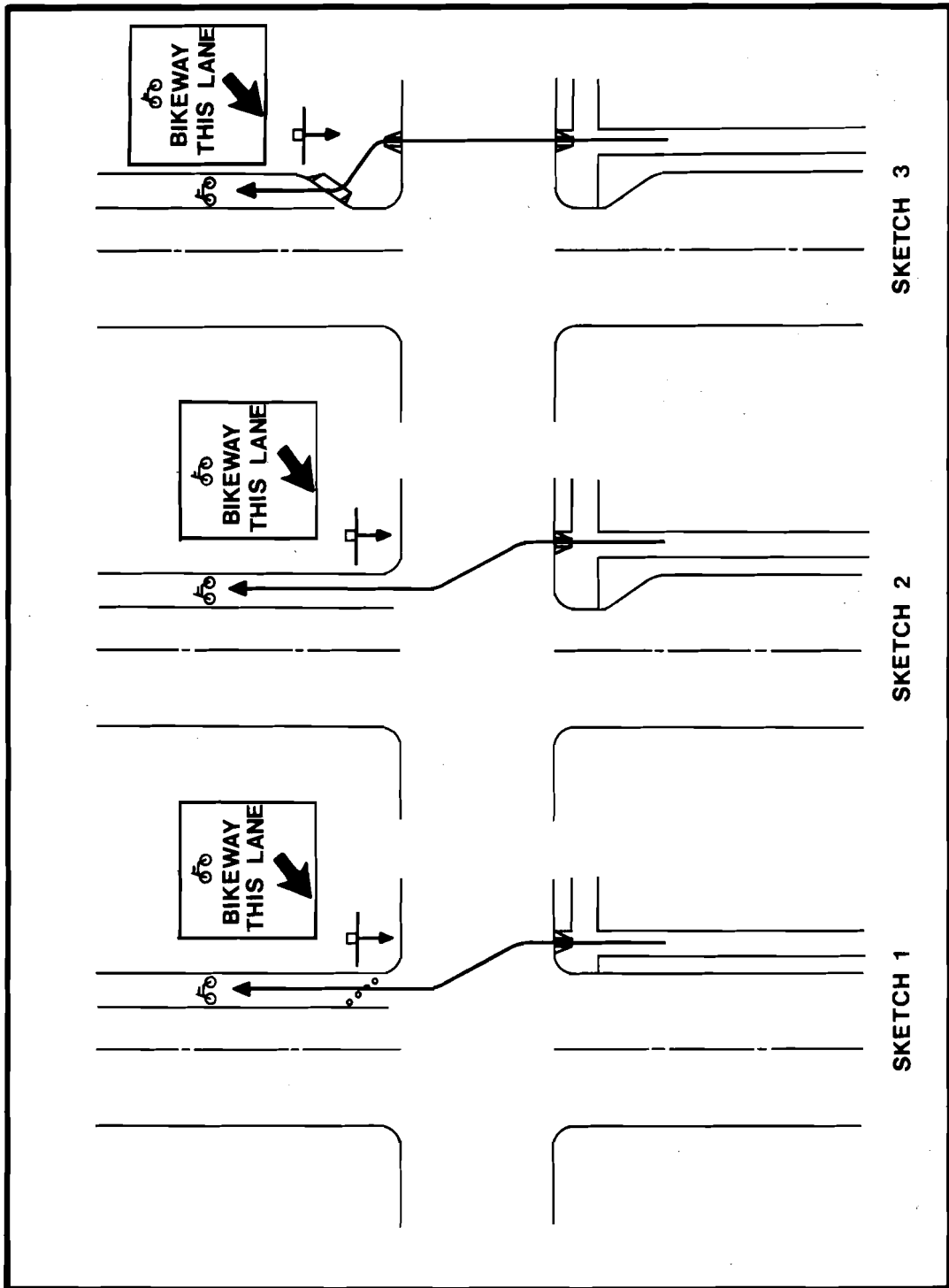

Figure VI-31 SIDEWALK PATH/BIKE LANE TRANSITIONS

buttons. The highest level of safety is attained through use of the technique depicted in Sketch 3. In all situations, bikeway boundary lines could be used crossing the intersection. Similar bikeway transitions can be employed at mid-block locations (Figure VI-32).

The need for new or relocated drainage facilities should be a consideration in the choice of which transition technique is most appropriate.

Bike Path

The problems associated with the separate Bike Path and its crossing of a roadway are dependent on its proximity to a parallel street. When its location is within a parallel street right-of-way, the distance of the path from the parallel roadway would be small and the preceding Sidewalk Path information would apply.

However, if the crossing is isolated, or mid-block, some different considerations must be made. The Federal Highway Administration in its Bikeways-State of the Art - 1974 (24) cites four factors which contribute to high accident experience with this type facility:

- 1) Failure to establish proper sight clearance zones as defined in Figure VI-8.
- 2) Poor perception of or reaction to crossing signs and markings.
- 3) Motorist expectation of entries to the crossing at pedestrian speeds rather than at typical bike travel speeds.
- 4) Cyclist disobedience of STOP or YIELD controls.

The opportunities for providing greater sight clearance may be better with a Bike Path than with a bikeway on the roadway or sidewalk. The designer should select the path location which takes advantage of the natural terrain and plant growth to enhance crossing visibility.

Where a path intersects a roadway with low vehicular volumes, STOP or YIELD signs for motorists, in addition to STOP signs for bicycle traffic, may be appropriate. Since motor vehicle operators tend to obey such controls, a higher level of safety would be obtained than with reliance on only the bicyclist's observance. In situations of moderate or high motor vehicle volumes and large numbers of bicycles, an automatic or bicyclist actuated traffic control signal may be warranted. A suggested means of inducing bicyclists to stop or slow down prior to crossing the roadway is shown in Figure VI-33. Horizontal or vertical deceleration curves are constructed into the path at the approach to the roadway. Low physical barriers are placed to assure confinement to the path and prevent short cuts.

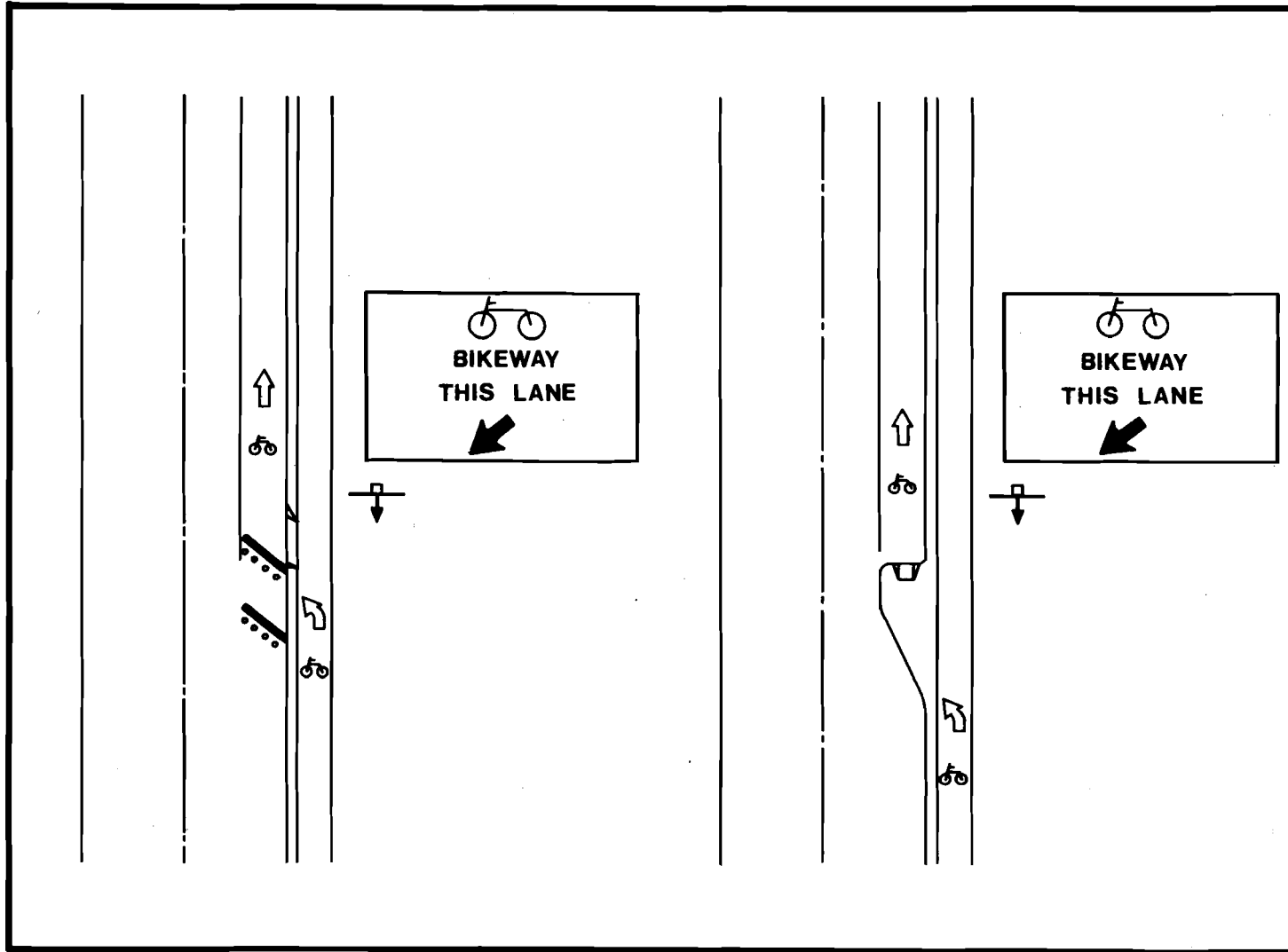

Figure VI-32 SIDEWALK PATH/BIKE LANE
TRANSITIONS-MIDBLOCK

At problem intersections where the bicycle operators must stop, dismount, and cross on foot to assure the highest degree of safety, methods must be devised to guarantee compliance. One way of achieving this goal, in addition to proper signing, is by having the Bike Path terminate at the roadway at a six-inch vertical curb.

Railroad Crossings

Where a designated bicycle facility crosses a railroad track, consideration must be given to the potential for bicycle upset. Not only are the metal rails slippery when wet, but the train wheel flange groove can trap a bicycle tire that approaches at an angle that is too flat. Two suggested methods are shown in Figure VI-34 to permit a more perpendicular crossing of the bikeway path. Figure VI-35 shows a commercially available rubberized crossing which can provide the necessary safety for bicycles. This material is available in three foot segments and includes a flexible filler material for the flange groove which can support the load of a bicycle.

GRADE SEPARATION

The safest and most effective method of solving intersection and crossing problems is by separating the conflicting traffic on different grades. Where the bikeway facility intersects limited access freeways, major roadways, or major railroad lines, consideration of a grade separation or a rerouting of the bikeway is required. No quantitative warrants have yet been established for bikeway grade separation. Some items which should be considered when evaluating the degree of need for a grade separation structure are:

- The availability of alternate routes.
- The desire to maintain continuity of the bikeway.
- The desire to maintain or encourage neighborhood cohesiveness.
- The intersecting motor vehicle volumes.
- The intersecting motor vehicle speeds.
- The intersection sight distance.
- The desire to maintain uninterrupted flow of intersecting motor vehicle traffic.
- The cost of grade separation structure alternatives.
- The expected volume of bicycles.
- The combined number of bicycles and pedestrians expected to use the facility.

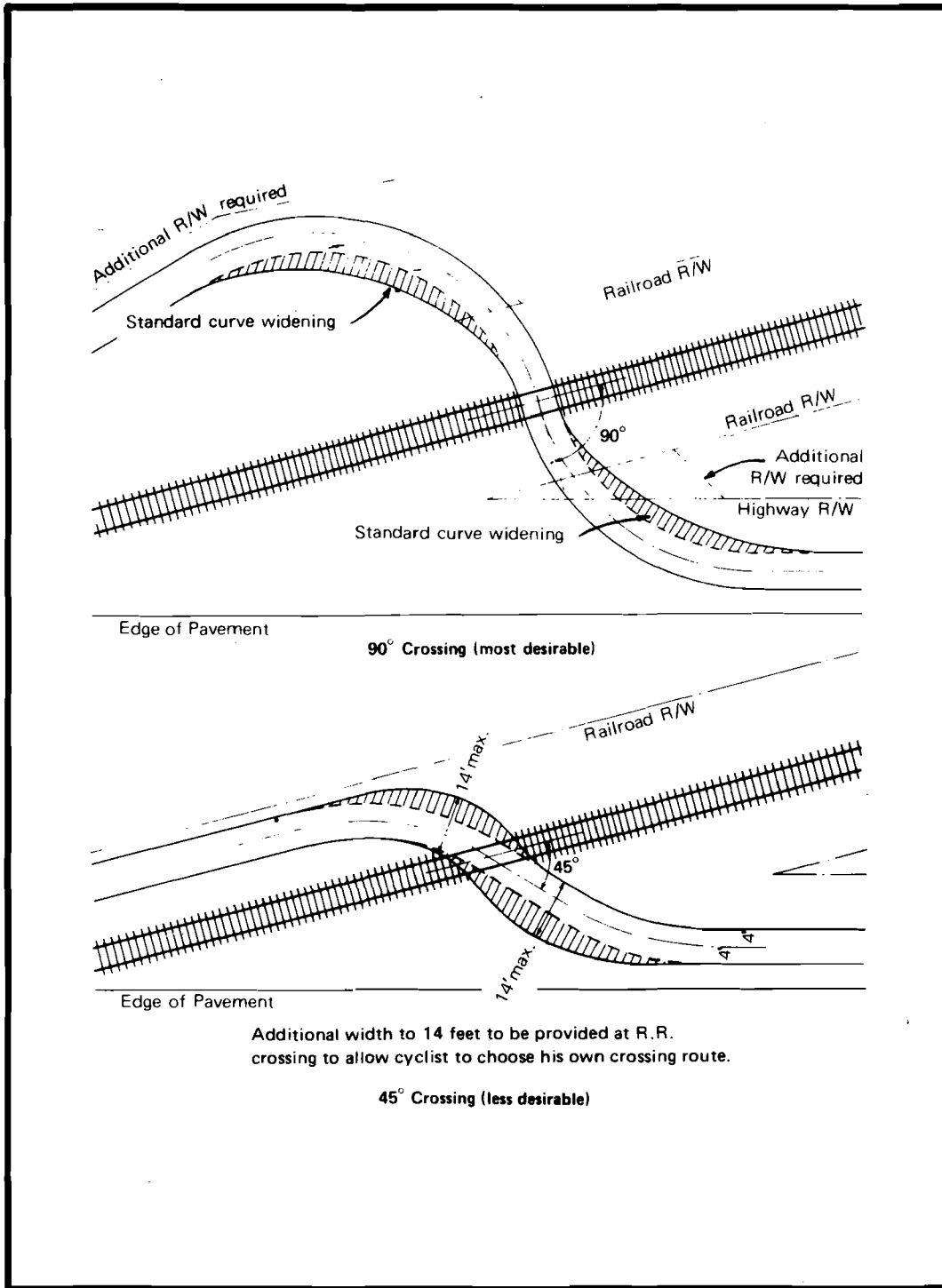

Figure VI-34 BIKEWAY/RAILROAD CROSSINGS
 SOURCE: State of Oregon, Bikeway Design



Figure VI-35 RUBBERIZED RAILROAD CROSSING
Tacoma, Washington

In the case of crossing railroad owned property or other privately owned land, the needs and desires of the owner will be paramount.

The choice of whether grade separation is achieved by an underpass or overpass depends to a large extent on the topography and general soil conditions at the location site. A principal consideration should be to maintain, as well as possible, a level bikeway path. Not only is this advantageous for the bicycle operator, but it can reduce the cost of the structure (Figure VI-36).

In general, the underpass structure will be preferred by bicyclists in spite of the concerns for personal safety due to its confining nature. This is because the bicycle operator can build up speed on the downgrade approach, thus less effort to pedal up the exit grade. The grades can be shallower than those for an overpass because the bikeway vertical clearance requirements are less than those needed above the roadway.

Ramp grades for both underpass and overpass structures should be as shallow as possible; grades over 5 percent can be hazardous in confining situations with large numbers of bicyclists present (25). Approach ramps or stairs on overpasses which require carrying or walking the bicycle should be avoided. Sharply curving ramps can be a safety hazard for the descending bicyclist.

Barriers, channelization and signing should be used to discourage the bicycle operator from continuing to cross a grade. A well designed structure, with the needs of bicyclists in mind, will reinforce the traffic control messages.



A major bikeway grade separation structure.



A simple bikeway grade separation of corrugated pipe. Note minimized adverse grade profile on bikeway made possible by elevation of roadway and use of underpass.

Figure VI-36 GRADE SEPARATION STRUCTURES

SOURCE: U. S. Dept. of Transportation,
Bikeways-State of the Art-1974

SIGNS AND MARKINGS

Signs, pavement delineations and markings are essential to all designated bikeways. The Bike Path can function, in an informal manner, once the path surface has been constructed. However, in order to attain the highest degree of safety and operational efficiency, it too must be signed and marked.

Signs

Signs, through their ability to convey messages to all persons, are a prime consideration in bikeway design. They establish the hierarchy of users on the facility and, thereby, reduce confusion and conflicts. This results in a safer environment for all. Signs also warn pedestrians and motorists of the presence of bicycle traffic. Bikeway signs, stemming from the newness of such facilities in most communities, are additionally educational to all persons that encounter them.

The standard signs approved by the National Joint Committee on Uniform Traffic Control Devices which have the most frequent application on bikeways are shown in Figure VI-37. Other standard signs do have occasional use. Because of the lack of a broad variety of standardized bikeway signs and the need for them, many jurisdictions have developed their own sign designs. The City of Seattle, for example, uses the standard Bike Route sign modified to read BIKEWAY to differentiate between the two types of facilities used in the community (Figure VI-38). It is desired that this difference -- subtle in nomenclature but vastly different in operation -- will be conveyed to the motorists and bicyclists. The State of Oregon authorizes the use of signs directed toward the bicycle operator (Figure VI-39). Many other special signs are in use throughout the country. In all cases, signs with new messages should follow the principles stated in the Manual on Uniform Traffic Control Devices.

Bikeway signs should be located at all significant decision points to inform the roadway or path users of its existence and the direction of the path. However, care must be exercised in spacing the signs to maintain the the highest aesthetic environment while assuring the maximum safety to the bicyclists. The design of special purpose signs requires an awareness of how the size and number of signs will affect the neighborhood and, the need to make sign message concise, understandable, and legible. Figure VI-40 presents the development of a sign to meet those criteria.

WHITE / GREEN



D11-1
24" x 18"
24" x 6"

BLACK / WHITE



R5-3
24" x 12"

BLACK / YELLOW



W11-1
30" x 30"
24" x 18"

Figure VI-37 STANDARD BIKEWAY SIGNS

SOURCE: Manual on Uniform Traffic Control Devices



Figure VI-38 BIKEWAY SIGN

Seattle, Washington

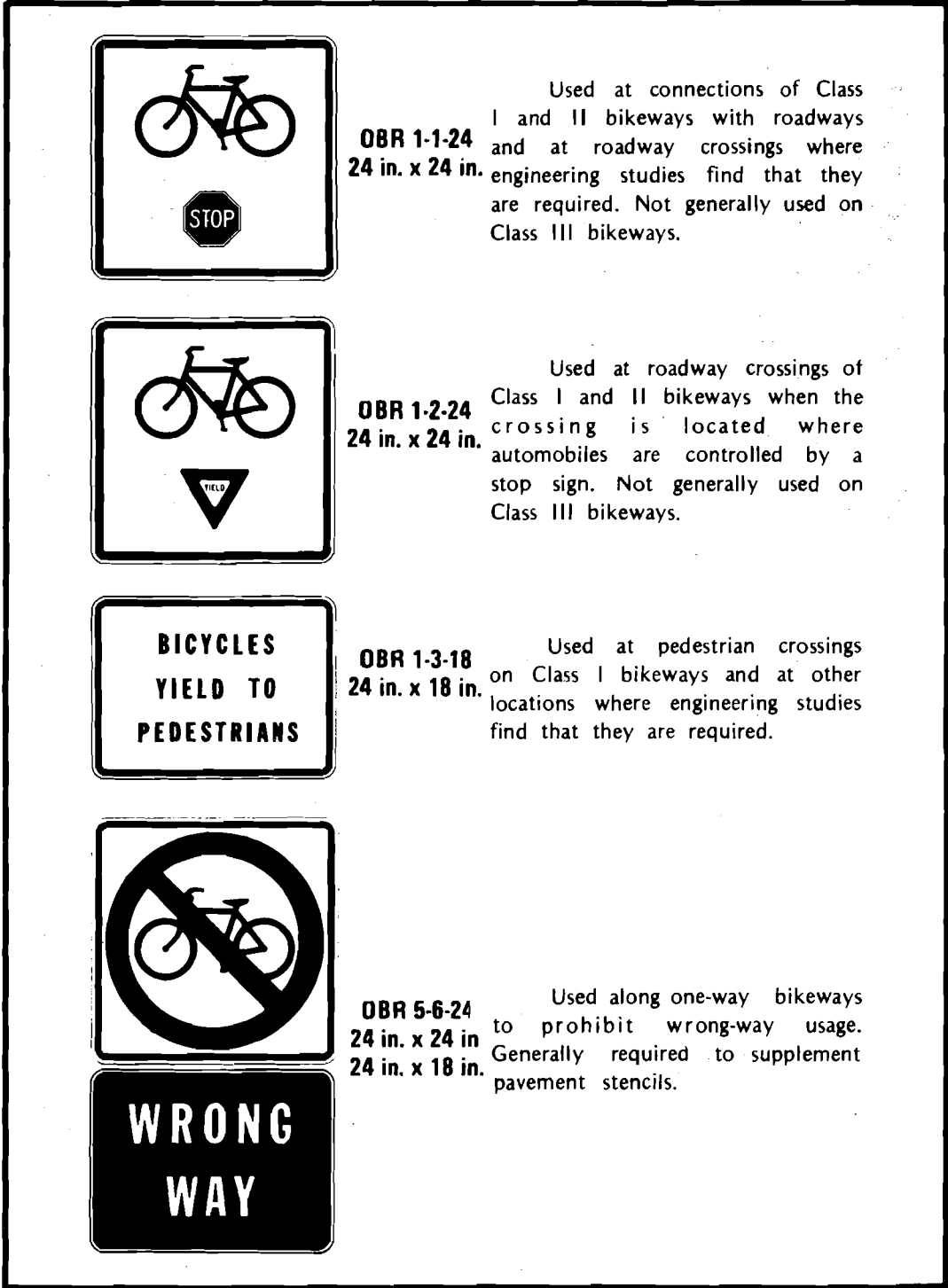

OBR 1-1-24
24 in. x 24 in.
 Used at connections of Class I and II bikeways with roadways and at roadway crossings where engineering studies find that they are required. Not generally used on Class III bikeways.

OBR 1-2-24
24 in. x 24 in.
 Used at roadway crossings of Class I and II bikeways when the crossing is located where automobiles are controlled by a stop sign. Not generally used on Class III bikeways.

OBR 1-3-18
24 in. x 18 in.
 Used at pedestrian crossings on Class I bikeways and at other locations where engineering studies find that they are required.

OBR 5-6-24
24 in. x 24 in.
24 in. x 18 in.
 Used along one-way bikeways to prohibit wrong-way usage. Generally required to supplement pavement stencils.

Figure VI-39 SPECIAL BIKEWAY SIGNS
 SOURCE: State of Oregon, Bikeway Design



BLACK/WHITE

Figure 4.40 Sign Development

Seattle, Washington

Source: City of Seattle, Bikeway System Planning & Design Manual

Sign placement along the roadway or sidewalk should provide sufficient clearance for motor vehicles or pedestrians. The Manual on Uniform Traffic Control Devices (26) specifies a minimum of seven feet of vertical clearance above the elevation of the roadway and a horizontal clearance of two feet. While these specifications reflect the best viewing line-of-sight for most motorists, the vertical dimension can be reduced to five feet when the sign is directed only to the bicyclist. However, it must be positioned where it does not create a sign obstruction, impede pedestrians, is not subject to vandalism or splash from passing motor vehicles, and does not interfere with aesthetic considerations. Such a sign location best considers the bicycle operator's normal downward angling field of vision and eye height of 4 to 5 feet. Lateral placement of the sign should be beyond the bicycle operational envelope shown in Figure VI-13. The signs should be placed to their best advantage for visibility considering such items as lateral offset, trees, shrubs, parked vehicles, and other traffic control signs which could interfere with their being seen. Additionally, signs affecting motorists during hours of darkness should be reflectorized or illuminated.

Bikeway warning signs should be positioned an adequate distance from the hazard to permit appropriate perception and reaction time. While a minimum of 50 feet has been recommended to allow a single wheel panic stop on dry asphalt (27), the topography, the nature of the hazard, and the expected operating conditions should dictate the actual distance needed. Visibility of sign messages directed toward the bicycle operator during hours of darkness should be a concern of the bikeway designer. The anticipated hours of high bikeway usage can aid in the final determination on whether illumination is required.

Pavement Delineation

Where it is necessary to separate the bicycles from other users of the roadway, sidewalk, or path, or where the lanes for two directional flow of bicycles must be defined, various methods are used to delineate the boundary line.

The most common method has been through use of a painted line. Although the Manual of Uniform Traffic Control Devices (28) specifies a solid white line to separate traffic flow in the same direction, some communities have used unique colored paint for this bikeway purpose. The City of Seattle, for example, used an unassigned standard color from the MUTCD (29) for its Bike Lane boundary line delineation. The color, strong yellow/green, was chosen because of a need to provide a means of continuously directing the attention of the roadway users to this novel roadway facility.

The uncommon color commands the attention of roadway users familiar with normal boundary paint line colors and enhances the safety of the bicyclists in the bikeway by discouraging voluntary encroachments, and is thus, a benefit to all roadway users. In conjunction with

proper signing and pavement markings, a distinctive color paint line conveys a clear, concise and simple message which is respected by most motorists and bicyclists. After the initial experience, motorists appear to respond rapidly to other bikeway facilities identified with the same boundary line color. Many motorists may be ignorant of or complacent to the message white pavement boundary lines are supposed to convey. A new color, however, can stimulate interest and increase awareness of the other elements of the bikeway installation.

Reflectorized and nonreflectorized traffic control buttons or bars have been used various size to further delineate bikeway boundaries. The size and spacing has, at times, been chosen to reduce the inadvertent encroachment by motorists. Figure VI-41 shows an application of traffic control buttons within the Bike Lane to decrease accidental use of that part of the roadway by motorists. The decision to use raised markers in conjunction with a bikeway must be balanced against the eventuality of their being struck by bicycles and motor vehicles and any resulting difficulties.



Figure VI-41 TRAFFIC CONTROL BUTTONS
Seattle, Washington

Note: Button size 8" diameter by 1 3/4"

Where a higher level of safety is desired than can be attained through a symbolic barrier, curbing and planter boxes have been employed. It should be kept in mind that any device placed within or in close proximity to the roadway will on occasion be hit by the roadway users. The effect of this obstruction on the users should be carefully weighed. (The State of Washington requires a mountable curbing to separate bicycle traffic from motorized traffic in adjacent lanes when bicyclists and motorists are moving in opposing directions). Any physical barrier control device should provide for customary flow of water and not cause puddles. The barrier must allow normal access and egress by the bicyclists using the facility in addition to access by adjacent property owners.

The bikeway designer must evaluate the possible adverse effects of the inattentive bicycle operator. Figure VI-42 demonstrates an approach used in Seattle, Washington to minimize the possibility of bicycle upset. A pre cast concrete curb was used to establish the edge of a two-way bikeway placed on an existing roadway between the parking lane and the original curb. The asphalt shim provides a slope that deflects the careless bicycle operator back toward the bikeway rather than toward the curb and parked vehicles. It also eliminates the possibility of pedal contact with the curb. Tests indicate that it functions as designed.

Pavement Markings

Symbolic and lettered pavement markings are used to supplement and reinforce the messages of posted signs. The message of the pavement marking must be emphatic and clearly understandable to the motorists traveling at normal operating speeds.

The use of the bicycle symbol to identify the Bike Lane, although conforming to the recommendation of the Uniform Manual for symbolic messages (30) becomes ineffective as the bikeway width approaches the minimum dimension. Either the bicycle symbol must be made very narrow or placed lengthwise; neither solution satisfies the desire for clarity. The words BIKE LANE (31) or BIKE ONLY in five foot letters (32) may be preferable. The BIKE ONLY message conveys a higher degree of exclusivity of the facility for bicycles.

Other pavement markings in use include STOP, YIELD, SLOW, and turn arrows. All painted pavement markings, including ladder and zebra striped crossings, should be evaluated prior to installation for the extent to which they contribute to wet weather slipping. The choice of proper spacing and width of the painted lines or use of abrasive material in the paint can reduce this tendency. In most communities pavement markings are painted white.

SIGNALIZATION

An important consideration during the bikeway location study is whether complex, heavily traveled intersections to be crossed are signalized. Where no signal exists and grade separation is not feasible, studies should be made to determine if a signal installation is warranted. Although no refined bicycle warrants have been established for signalization, the method and volume used to justify a signalized pedestrian crossing can suffice (33).

Another approach to justification is a cost/benefit analysis. The predicted daily bicycle volume and the time and magnitude of the peak period is compared to the volume of motor vehicles on the intersecting roadway. A determination of the number of acceptable gaps in the motorized traffic (34) can provide a measure of the probable frequency of bicycle/motor vehicle accidents caused by bicyclists' acceptance of improper gap size. Observation has shown that as the bicycle queue size approaches six to eight, a "forced crossing" will occur with

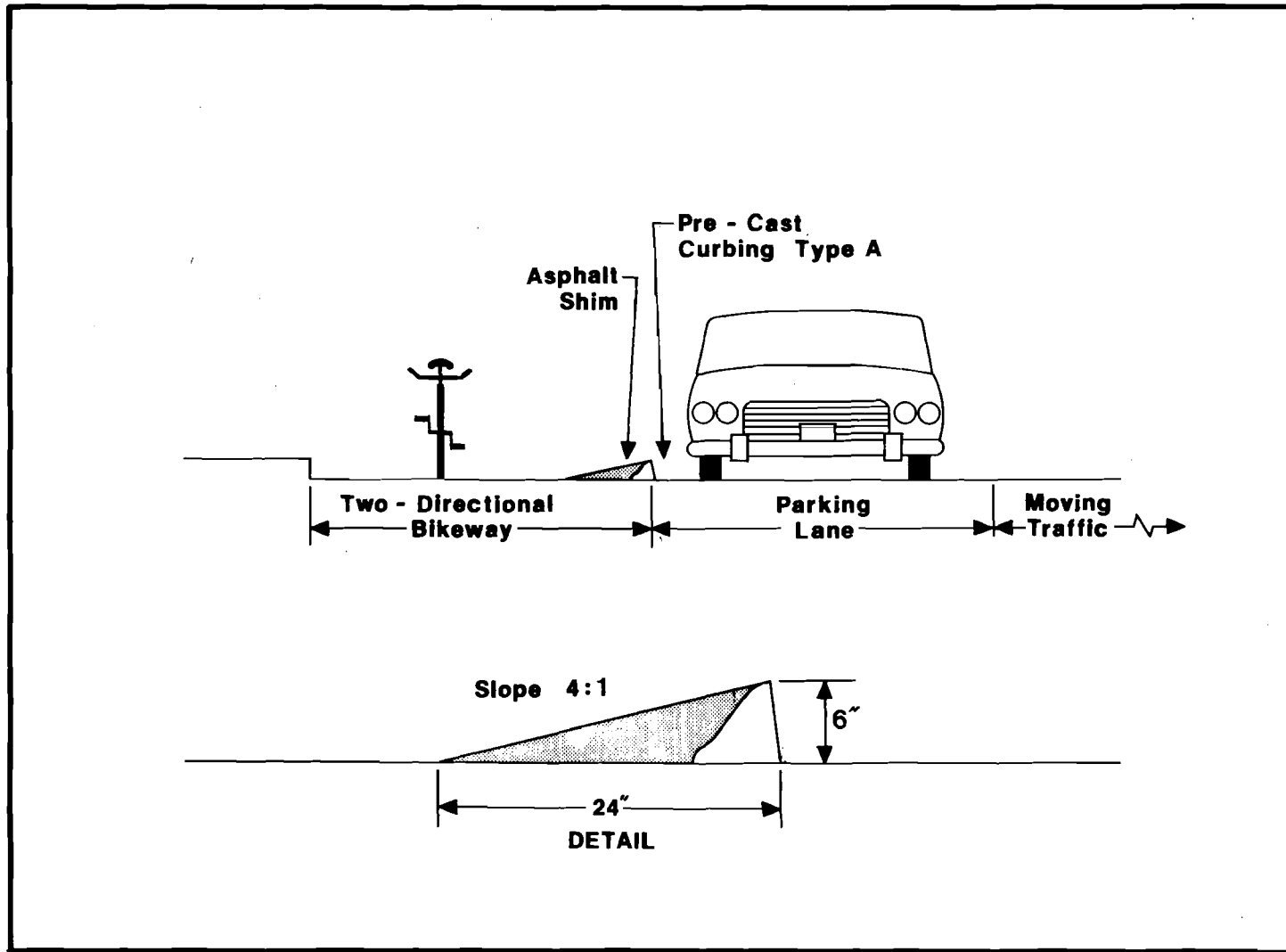

Figure VI-42 "BICYCLE SAFE" CURBING

disruption to the traffic flow and increased collision potential (35).

Using the cost/benefit approach to evaluate signal installation at an intersection, one should consider:

Cost

Installation and Maintenance
Motor Vehicle Delay Time
Increased Noise and Air Pollution

Benefit

Accident Reduction
Bicycle Delay Time
Queue Size "Forced Crossing"

Some of the above items are not easily quantified and will require the judgment of a trained traffic engineer. Where installation of a signal will additionally serve pedestrian and motorized traffic, those benefits should be included.

If the need for signalization cannot be substantiated, an alternative bikeway route should be considered. When a traffic signal exists or one is to be installed on a bikeway, it may be desirable to provide bicycle actuation. This can be accomplished by mounting a standard pedestrian actuation button within easy reach of the bicyclist. Some communities have placed the buttons a distance before the intersection to assist the bicycle operator in a stop free crossing. This practice requires proper sight clearances to assure entry into an unoccupied roadway.

Another means of signal actuation is through the use of magnetic induction loops. These are reportedly in use in Europe (36).

LIGHTING

Bikeway illumination is a requirement for safe traffic operation during hours of darkness. Typical bicycle headlights do not provide the intensity or beam width to fully illuminate the pavement for normal bicycle operating speeds or to adequately inform motorists of the bicycle's presence at intersections. Fixed lighting permits the bicycle operator to identify hazards to bicycling like broken glass, potholes and drainage inlet grates. It also makes construction features of the facility visible, such as curbing, bicycle ramps, traffic control buttons, and the bikeway delineation boundary line. On BIKE PATHS and SIDEWALK PATHS, illumination permits the bicyclists and pedestrians to see each other.

The height and lateral placement of street lights should assure a minimum of 0.5 foot candles on the surface of the bikeway while the spacing meets a uniformity ratio requirement (average horizontal foot-candles divided by the minimum horizontal foot-candles) not to exceed 3:1. Existing lighting may require adjustment in mounting or lense to achieve this goal.

At all intersections, the level of illumination should be the sum of the recommended illumination for all intersecting roadways and paths. Transition illumination should be provided to allow the bicyclist to adjust to the varying light conditions. A minimum distance of 330 feet on each side of the crossing has been recommended to provide 15 seconds of adjustment time for bicyclists traveling at 15 mph (37). Luminaire placement at dimly lit crossings should back light the bicyclists to present a silhouette to the approaching traffic. The use of reflectorized paint for the bikeway delineations and markings could further assist in bikeway crossing identification during darkness.

Where a substantial cost is involved in providing adequate light levels, the decision on whether lighting is required is determined by the amount and difficulties of anticipated night-time use. However, when funds are not available and frequent use is expected, alternative solutions should be considered. One approach is to provide minimal lighting only at high conflict areas or where personal safety is the paramount issue. Another method is full closure of the bikeway by signing or physical barriers, or to allow travel at the users risk.

SUPPORT FACILITIES

The application of support facilities to enhance the utility of a bikeway is recommended. The type of incidental improvements considered will depend, to a large extent, on whether recreational or transportation bicycle use is anticipated to predominate.

Recreational

Parking areas should be provided when large numbers of users are expected to arrive by automobile. Their location and size can encourage a more uniform volume of bicycles along the full length of the bikeway. It is preferable that these sites also have toilets, litter containers and picnic accommodations. Rest areas are desirable along lengthy, isolated urban Bike Paths at 3 to 5 mile intervals. These should have toilets, drinking fountains, benches, litter containers and bicycle racks. An occasional minor rest area at intermediate viewpoints and historic locations will add to the effectiveness of the facility. On isolated paths, directional signing to off-path amenities such as bicycle repair shops, service stations, food or grocery stores, and restaurants will contribute to the bicyclist's enjoyment.

Transportational

The large variety of bicycle trips for utility purposes precludes an examination in this Manual of the support facility needs of each. During the bikeway design, and especially when forecasting the trip generation, many specific facility locations and requirements will become apparent.

The need for terminal facilities for commuter bicyclists will depend on the length and physical difficulty of the journey and the anticipated activity at the destination. A trip as short as three miles in hilly terrain might require a shower for an office worker but be of little concern to a student. Clothing lockers are helpful and may encourage additional bicycle volumes when included with shower accommodations. Bicycle storage which provides security for the bicycle and is convenient to the operator's destination must be supplied to gain the greatest use of the bikeway. The "chicken and egg" argument regarding the relative importance of a bikeway or terminal facility as being the major contribution to increased commuter bicycle usage still continues. Suffice to say, for this Manual, the inclusion of terminal facilities for a commuter bikeway must be made.

When a bikeway terminates at or passes through an activity center with a large parking demand, the development of free "park and pedal" lots at peripheral locations should be considered. This would allow persons living a considerable distance from the bikeway to transport their bicycles by automobile to the lot and complete their trip by bicycle. The most congested part of the usual automobile trip would be eliminated. This type facility, if located within an easy fifteen minute ride of the destination (3 miles at an average speed of 12 mph), could reduce parking demand and increase bicycle volumes.

Another support facility that could have great benefit for the community is the provision of safe bicycle storage at transit stops. It has been estimated that the addition of bicycle lockers or racks will increase the "serviced area" of a stop by a least a factor of 15 and, thereby, substantially increase the potential transit ridership (38). It is important to note that at least ten bicycles can be stored in the space needed for one automobile. Where parking space is in great demand at "park and ride" transit terminals, the encouragement to arrive by bicycle could have a definite cost advantage to the transit company.

MAINTENANCE

The extent to which a bikeway is maintained will determine whether the community purchased a benefit or a liability with its investment. A well maintained facility will encourage greater use while a rundown, cluttered bikeway will cause discontent. The bikeway designer, through judicious selection of design features can facilitate ease of maintenance of the finished bikeway.

The width of Bike Paths, Sidewalk Paths, and Bike Lanes which are contained between permanent physical obstructions should permit use of locally available maintenance vehicles. Street sweepers, paving equipment, snow removal machines, grass mowers, and brush trimmers are but a few of the vehicles which occasionally will be traveling along a well maintained bikeway.

When it is not possible to provide adequate width for mechanized equipment, it should be recognized that higher labor costs will result from the greater amount of hand labor necessary to accomplish the same amount of work.

The frequency of sweeping a bikeway will be dependent on local conditions and needs. Some bikeway locations may experience a periodic increase in objectionable debris which needs removing (e.g., broken glass beverage bottles in the bikeway at the beginning of the week).

Weeds and grass should be kept trimmed at the edge of the bikeway to enhance visual definition, especially if the surface adjacent to the path is not recommended for bicycling. In addition, the lower vegetation height will lessen the tendency to trap wind carried debris and snow.

Repairs to the bikeway surface should be smooth. An elevation difference up to 3/4 inch is acceptable if the transition between the two surfaces is no more abrupt than a 4:1 slope.

Paint lines, signs and other traffic control devices should be renewed or replaced to suit local conditions. Faded paint lines or vandalized signs which jeopardize the safe operation of the facility should be corrected when they are recognized.

REFERENCES (CHAPTER VI)

1. A comparison between the definitions used in this Manual and those from five other publications is given in the Appendix.
2. Washington, State of, Department of Highways, "Highway Design Manual", April, 1975. pp. 3-30.04, 3-30.04 (1)a - 3-30.04(1)c.
3. American Association of State Highway and Transportation Officials, "Guide for Bicycle Routes", (Washington:1974).
4. U.S., Federal Highway Administration, Federal-Aid Highway Program Manual, Vol. 6, Chap. 1, Sec.1, Subsec.1. March 8, 1974.
5. Santa Barbara, City of, Public Works Department, The Proposed Bikeway Master Plan, May, 1974, p.44.
6. U. S., Federal Highway Administration, Deleuw, Cather and Company, Bikeways - State of the Art - 1974, Washington, D.C., July, 1974. p.13.
7. Bikeways - State of the Art - 1974, op. cit., p.7.
8. Oregon, State of, Oregon State Highway Division, Bikeway Design, Salem January, 1975. p.3.
9. Bikeways - State of the Art - 1974, op. cit., p.34.
10. Institute of Traffic Engineers, Traffic Engineers Handbook, Washington D.C., 1965, p.82.
11. Ibid., p.30.
12. Oregon, op. cit., pp. 9-10.
13. ITTE, op. cit., p.22.
14. AASHTO, op. cit., p.20.
15. ITTE, op. cit., p.27.
16. AASHTO, op. cit., p.21.
17. Deleuw, Cather and Company, Davis Bicycle Circulation and Safety Study, San Francisco, August, 1972, pp. 49-50.
18. Walter L. Cook, Bike Trails and Facilities, A Guide to Their Design, Construction, and Operation, American Institute of Park Executives, p.5.
19. AASHTO., op. cit. p.22.
20. Cook, op. cit., p.6

21. Oregon, op.cit., p.6.
22. The basic information presented here and in the following illustration is from the DeLeuw, Cather and Company publication, Davis Bicycle Circulation and Safety Study, cited in Reference 16 above. Liberties have been taken with the original illustration to present different or additional information.
23. Seattle, City of, Bicycle Safety Study, Seattle, May, 1975. p.62.
24. Bikeways - State of the Art - 1974, op. cit., p.50.
25. Davis Study, op. cit., p.49.
26. U. S. Federal Highway Administration, Manual on Uniform Traffic Control Devices, Washington, November, 1970, p.271.
27. ITTE, op. cit., p.124.
28. MUTCD, op. cit., p.179, 186.
29. Ibid., p. 3-9.
30. Bikeways - State of the Art - 1974, op. cit., p.72.
31. Washington, State of, op. cit.
32. Bikeways - State of the Art - 1974, loc. cit.
33. MUTCD, op. cit., pp. 237-238.
34. Ferrara, Thomas C., A Simulation Model of Bicycles Crossing a Two-Lane Two-Way Street, Paper presented at the Annual Meeting of the Transportation Research Board, Washington, D. C., 1975, p.6.
35. Ibid., p.4.
36. Bikeways - State of the Art - 1974, op. cit., p. 61.
37. ITTE, op. cit., p.139.
38. Atlanta Regional Commission, Barton-Aschman Associates, Inc., The Bicycle, St. Paul, July, 1974, p.20.

CHAPTER VII

BIKEWAY EVALUATION

CHAPTER VII

BIKEWAY EVALUATION

A completed bikeway facility will represent a substantial investment of community time and effort. Costs will have resulted from gathering data and developing alternative design solutions for review by the public and the decision makers. Dollars will have been spent to build the bikeway. Some unanticipated impacts to the general public may have occurred public that should be ameliorated. An evaluation of the effectiveness of the the new facility needs to be compared with its costs in order to judge the worth of the community's investment.

This chapter describes some methods for evaluating a completed bikeway. Some data will require a period of time in which to accumulate a sufficient base before being usable. Other information can be gathered and used immediately after construction. However, it should be kept in mind that weather causes seasonal variation in bicycling and, therefore, any direct comparison of a period before bikeway construction and a period after should contain the same months of the year.

The following methods provide a full range of information to aid in an evaluation of a bikeway:

1. Bicycle Volume on Bikeway - Bicycle volume counts taken at several locations along the bikeway route prior to and after construction can measure the change in ridership resulting from the facility.
2. Bicycle Volume Within Area - Bicycle volume counts at selected locations within the bikeway service area before and after construction help to evaluate how well the facility has attracted riders from streets within the corridor.
3. Accident Data - All records of accidents within the corridor, before and after construction, give an indication of the effect on safety resulting from the bikeway.
4. Roadway User Survey - A survey of users of all transportation modes along the route is a measure of the impact resulting from the bikeway.
5. Direct Observation - Observation of the ability of roadway users to accommodate to the changed traffic conditions.
6. Citizen Response - Solicited response of individuals and businesses along the bikeway route are a good source of information about the facility's effect on the community.

Bicycle Volume on Bikeway

Bicycle volume counts should be taken at significant locations along the bikeway route prior to and after construction. The frequency and location of each station will be dependent on the amount of information desired and the complexity of the roadway arrangement where the bikeway is being installed. Both sets of data must be gathered at the same locations and attempt to closely approximate each other in the commuter/recreational orientation of the bicycle operator being counted and the day of the week of the operation. The sex and estimated age of the persons passing the counting stations on the two occasions can indicate a shift in user characteristics caused by the facility.

The bicycle volume data should be collected for a sufficient portion of the day to include the peak volume period. The information should be tabulated at fifteen minute intervals to clearly define the peak period. In addition to total bicycle volumes entering an intersection, all turning movements should be recorded.

A study of the bicycle use information developed in the above fashion allows answers to be given to the following questions:

1. Did the bikeway have an effect on bicycle volumes?
2. Are there volume changes along the entire route or only at some locations?
3. Are the volumes and peak time period in accord with the estimates?
4. Do turning movements indicate an attraction to the bikeway?
5. Does the sex and age of the users conform with the expected client?
(Did a commuter facility generate a strong recreational use or visa versa?)

An analysis of the answers to these questions is one step toward the final bikeway evaluation.

Bicycle Volumes Within The Area

A similar operation to that of the preceding section should be conducted within the serviced area adjacent to the bikeway. The counting station locations should be coincidental with often used bicycle routes identified by surveys or counting techniques. When no information is available, direct observation in the effected area may assist in deciding the locations. The enumerators at the stations should direct their attention toward counting the bicycles that appear headed in a direction serviced by the bicycle route. Counts of all

other bicycle movements should be taken at each station, but may have little value in assessing the attraction of the bikeway facility.

As in the case of comparing tabulations of bicycle movement on the bikeway route, a series of questions can be framed to aid in the evaluation of the bikeway's impact throughout the adjoining neighborhood. However the more remote the counting station location is to the bikeway the greater the probability of error in assessing the influence of the facility.

Accidents

Accident records can be used to indicate the effect on the safety of the roadway users resulting from the bikeway. Accident records involving bicycles and motor vehicles as well as all other motor vehicle accidents should be assembled and analyzed. Direct comparisons can be made between accident frequencies along the bikeway path before and after construction. Inferences can be drawn from the accident data in the surrounding area when used in conjunction with the before and after bicycle volumes.

Although many months will probably be required to build a sufficient data base for comparative purposes, constant surveillance of accidents occurring on the bikeway must be maintained, and corrective action taken as soon as a problem becomes apparent.

Roadway Users Survey

A survey of the users of the roadway and the bikeway can be a valuable aid in evaluating the success of the facility. The roadside interview survey technique described in Chapter III is suggested. A bikeway which appears to have created problems for the motorists or the bicyclists should either be corrected or relocated. Surveys can highlight needed improvements before irrevocable harm has resulted. The information obtained through roadway surveys can document support and opposition to the facility and will be a better gauge than that received from a biased vocal group. Some survey answers can be compared to observed practices along the bikeway route to judge the effectiveness of specific design details. Additionally, data gathered from surveys will indicate the amount of bicycle trips generated by the bikeway, the purposes of the trips, and the feelings of the safety of the bicycle operators.

The surveys should cover at least the following items:

Motorists

1. The extent of understanding of the operational features of the bikeway.
2. The perceived impact of the facility on travel time and safety.

3. The amount of previous use of the route.

4. If and how much respondent bicycles.

Bicyclists

1. Trip purpose (Recreational, Work, Shopping, Exercise, School, Other).

2. The perceived impact of the facility on travel time and safety.

3. The amount of previous use of the route.

4. Opinions on specific bikeway design features.

In addition the interviewer should note the sex and approximate age of the motorist or bicyclist and record the time of day and the direction of travel. It is also helpful to gather information on the years of bicycling experience.

Direct Observation

In the case of specific features, evaluation is best done by observing how bicyclist, automobile drivers, trucks, buses and pedestrians react. The use of a particular design feature can be filmed or video taped and reviewed several times. Where the equipment is available the video taped activity can be played back at increased speed so that several hours of observation can be viewed quickly. Observers should pay particular attention to how well all users obey regulatory signing, signals, channelization and other traffic control devices.

Motor Vehicle Volume and Parking Impacts

In addition to the observation of motorist's behavior changes resulting from the bikeway, comparisons should be made of the facility's impact on traffic volume and speed. This can be done immediately after the bikeway is operational but will be more indicative of the true influence of the facility if a period of adjustment is allowed.

If on-street parking was allowed to remain along the bikeway, studies should be made to assess the bikeways effect. Where parking was removed to provide space for bicycle operation, the impact on the adjacent area should be reviewed and an evaluation made of the total influence.

Citizen Response

Persons who live or own businesses along the bikeway are another source of information necessary to evaluate the effect of the facility on the surrounding community.

Notification should be made to these individuals prior to construction to minimize negative reaction to the change. This will be in addition to the citizen involvement noted in previous chapters. Letters can be hand delivered directly to the properties along the route. Newspapers, including smaller community or neighborhood newspapers, along with radio and television can also be used to inform the neighborhood that the bikeway will be built.

Some of the questions which should be anticipated and for which answers and corrective strategies developed are:

1. Will the bikeway have an effect on on-street parking?
2. Will access to the abutting properties be affected?
3. Will an on-street bikeway cause traffic congestion?
4. Will large numbers of bicyclist riding through a neighborhood increase crime and vandalism?
5. Will the necessary bikeway traffic control devices degrade the attractiveness of the neighborhood?

By soliciting comment to the proposed improvement and reaction to the completed facility, valuable information can be obtained. Not only is the community given an outlet for expressing its concerns, but specific details will be uncovered for corrective action.

The information presented in this Chapter has been structured toward the evaluation of a single bikeway from within a total network. It could be relevant to decision makers to also consider the effectiveness of bikeway expenditures in terms of the entire system. As each bikeway is implemented it will probably enhance the bikeway system in serving urban bicycle travel. Indicators of this improvement may take the form of:

1. Increased bicycle usage.
2. Longer bicycle trips.
3. Lower bicycle/motor vehicle accident rate.
4. Increased bicycle accessibility throughout the community.
5. Improvements in urban recreation, health and environmental values.

Direct quantification of some of these benefits is often difficult. However, the techniques presented here, and in Chapter III, can be utilized to provide an indication of the overall effect of incremental changes.

APPENDIX

1. BICYCLE FACILITY CLASSIFICATION METHODS

2. CURVATURE RELATIONSHIP

APPENDIX A

The following five bicycle facility classification methods are in current use throughout the United States:

Institute of Transportation and Traffic Engineering (1)

- Class I: A completely separate right-of-way designated for the exclusive use of bicycles. Cross flows by pedestrians and motorists are minimized.
- Class II: A restricted right-of-way designated for the exclusive or semi-exclusive use of bicycles. Through travel by motor vehicles or pedestrians is not allowed. However, vehicle parking may be allowed. Cross flows by motorists, for example, to gain access to driveways or parking facilities, is allowed; pedestrian cross-flows, for example, to gain access to parked vehicles or bus stops or associated land use, is allowed.
- Class III: A shared right-of-way designated as such by signs placed on a vertical posts or stenciled on the pavement. Any bikeway which shares its through-traffic right-of-way with either or both moving (not parking) motor vehicles and pedestrians is considered a Class III bikeway.

Atlanta Metropolitan Region (2)

- Bike Route: A road signed for bicycling but with bicyclists sharing the road surface with other vehicles.
- Unprotected Bike Lane: A lane on street pavement separated from motor vehicle traffic only by a stripe marking the lane.
- Protected Bike Lane: A lane on street pavement separated from motor vehicle traffic by a physical barrier.
- Bike Track: A path within a motorized transportation right-of-way but separated from the motor vehicle movement surface by an intervening strip of land.
- Bikeway: A bicycle facility completely separated from a street or highway right-of-way.

State of Washington (3)

- Bicycle Ways:** These are facilities that allow a mixture of motorized vehicle and bicycle traffic in the same lanes, and are relegated to use in areas where low motorized vehicular volumes and low operating speed differentials are prevalent.
- Bicycle Lanes:** As bicycle and motorized vehicle traffic volumes and differential operating speeds increase, it becomes necessary to provide separate lanes for each mode of travel. In rural areas, an 8 foot paved shoulder with proper delineation and pavement marking is normally adequate to be designated as a bicycle lane. In urban areas, the prohibition of parking may be required to develop the bicycle lane concept.
- Bicycle Paths:** A point is reached where motorized vehicular volumes and operating speeds become too great to permit the operation of bicycles and motorized vehicular traffic immediately adjacent to each other. As speeds and volumes go up, greater separation must be provided. The alignment of a bicycle path need not necessarily parallel the alignment of the highway and should generally conform to the topography when possible to do so.

American Association of State Highway and Transportation Officials (4).

- Bicycle Route, Bicycle Way, or Bikeway:**
Any road, street, path or way which in some manner is specifically designated as being open to bicycle travel, regardless of whether such facilities are designated for the exclusive use of bicycles or are to be shared with other transportation modes.
- Bicycle Trail:** A separate trail or path which is for the exclusive use of bicycles. Where such trail or path forms a part of a highway, it is separated from the roadways for motor vehicular traffic by an open space or barrier.
- Bicycle Lane:** A portion of a roadway which has been designated for preferential or exclusive use by bicycles. It is distinguished from the portion of the roadway for motor vehicular traffic by a paint stripe, curb or other similar device.
- Shared Roadway:** A roadway which is officially designated and marked as a bicycle route but which is open to motor vehicular travel and upon which no bicycle lane is designated.

State of the Art (5)

- Bike Route:** A street or system of streets and ways with signs denoting them as a "Bike Route". The signs warn motorists to anticipate bicycles on these streets and indicate to cyclists a desirable routing because of low traffic volumes or good grade profiles, a possibility of scenic views or continuity to activity centers. Most commonly, "Bike Routes" imply streets in mixed usage but they may include segments of the various types of exclusive bicycle facilities described below. In noncapitalized form, "bike route" indicates the bicycle's line of travel to reach a specific destination. (A Class III facility).
- Bikeway, Cycleway:** Generic terms encompassing all of the exclusive bicycle facility treatments described below. Both most commonly denote bicycle facilities which are off the street or highway pavement but not necessarily separate from the roadway right-of-way.
- Bike Lane:** An on-street treatment in which separate auto and bicycle travel lanes are designated visually by signs and street markings. (A Class II facility).
- Protected Lane:** An on-street bike lane in which a positive physical separation is placed between bicycles and moving motor vehicle traffic. Separation may be achieved through striped buffer areas, raised and possibly landscaped median strips or by placing the lane between parked cars and the curb. (A Class I facility).
- Bike Path, Pathway:** Generic terms denoting bicycle facilities off the roadway surface, though not necessarily out of the roadway right-of-way.
- Sidewalk Path or Wide Sidewalk Treatment:**
A bike path within the roadway right-of-way which may be used by pedestrians as well as cyclists.
(May be Class I, II, or III)
- Independent Path:** A cycle facility in its own right-of-way, entirely separate from streets and highways. Includes pathways specially provided for bicycles, park and green belt trails, service roadways along utility rights-of-way, drainage and irrigation canals, etc. (Class I or II).
- Mall Treatment:** A block or blocks of city streets closed to motor vehicle traffic with the exception of emergency and possibly service and public transit vehicles.

TABLE A-1
COMPARISON OF BICYCLE FACILITY DEFINITIONS

This Manual	ITTE (1)	Atlanta (2)	Wash. State (3)	AASHTO (4)	State of the Art (5)
Bike Path	CLASS I	Bikeway	Bicycle Path	Bicycle Trail	Independent Path Bike Path
Bike Lane	CLASS II	Protected Lane Unprotected Lane	Bicycle Lane	Bicycle Lane	Protected Lane Bike Lane
Bike Route	CLASS III	Bike Route	Bicycle Way	Shared Roadway	Bike Route
Sidewalk Path					Sidewalk Path
Bike Street					Mall Treatment

REFERENCES (APPENDIX A)

1. Institute of Transportation and Traffic Engineering,
Bikeway Planning Criteria and Guidelines, University of California,
Los Angeles, April, 1972.
2. Atlanta Metropolitan Region, Barton-Aschman Associates, Inc.,
The Bicycle, St. Paul, July 1973.
3. Washington, State of, Department of Highways,
"Highway Design Manual", April, 1974. pp. 3-30.04,
3-30.04 (1)a - 3-30.04 (1)c.
4. American Association of State Highway Transportation Officials,
"Guide for Bicycle Routes", (Washington: 1974).
5. U. S. Federal Highway Administration, De Leuw, Cather and Company,
Bikeways - State of the Art - 1974, Washington, D.C., July, 1974.

APPENDIX B

CURVATURE RELATIONSHIP

An important area of bikeway design that has not been fully investigated is the relationship between the bicycle velocity and the minimum acceptable curve radius. In most cases, when the bikeway is to be placed on an existing roadway or sidewalk, little or no physical change will be possible to alter the curve radius to suit. However, when constructing a new path facility, opportunities may be present to permit a range of curve radii to be used. In all situations, whether using an existing condition, modifying it, or building to a new design, the design speed of the bicycle, and the curve it is negotiating must be compatible.

The University of California empirically derived an equation for the minimum comfortable unbanked radius using level, dry, paved asphalt (1).

$$R = 1.25V + 1.4$$

where R = Curve radius in feet
V = Speed in MPH

Although this formulation is probably valid within the speed range tested, it becomes impractical at higher speeds. As bicycle velocities increase, the bicycle/bicycle operator combination must assume a greater lean angle to ride safely through a given curve. As the lean angle increases beyond about 25 degrees, the possibility of most bicycles upsetting by "catching a pedal" is great. Sharper angles, smaller radii and higher velocities can be attained by coasting through the curve. As these elements are increased, a "break away" point will be reached at which the bicycle will slide out from under the operator.

The American Association of State Highway and Transportation Officials, on the other hand, provided a table of minimum radii of curvature for paths with token or no superelevation provided (2).

DESIGN RADII

Design Speed MPH	Design Radius Feet
10	15
15	35
20	70
25	90
30	125

The authenticity of this information is questioned, however, because of the erratic increases in radii for uniform steps in speed. Given the formula for determining the minimum curve radius published by the Institute of Traffic Engineers (3) the speed/radius relationship should be consistent:

$$R = \frac{V^2}{15(e+f)}$$

e = Superelevation, ft./ft.

f = Side friction factor

V = Speed, MPH

R = Radius, feet

The relationship between the minimum curve radius and the bicycle maximum speed shown in Figure 9, Chapter VI was developed from calculations using an acceptable bicycle lean angle. The "acceptable bicycle lean angle" was based on the establishment of a "design bicycle" and the premise that the maximum lean would occur with the inner pedal in the lowest position.

The dimensions (Figure B-1) from the center of the frame to the outermost path surface interference point on the pedal (A) and from that point to the riding surface (B) were measured for a large number of bicycles. From this range of information a design bicycle with a A and B combination resulting in a maximum lean of 25 degrees was chosen. The acceptable bicycle lean angle was then selected at 20 degrees to allow about one inch clearance between the pedal and the riding surface for the design bicycle.

This choice permitted all but about 10 percent of the bicycles measured to pedal comfortably through a curve radii derived from Figure VI-9.

Assuming that this angle is the maximum that can occur before the break away point then,

$$v^2 = RG \tan \theta$$

Where v = Speed, ft./sec.

$$\text{OR } V^2 = \frac{RG \tan \theta}{2.151}$$

Where V = Speed, MPH

R = Radius, feet

G = Gravity

and, $f = \tan \theta = .364$

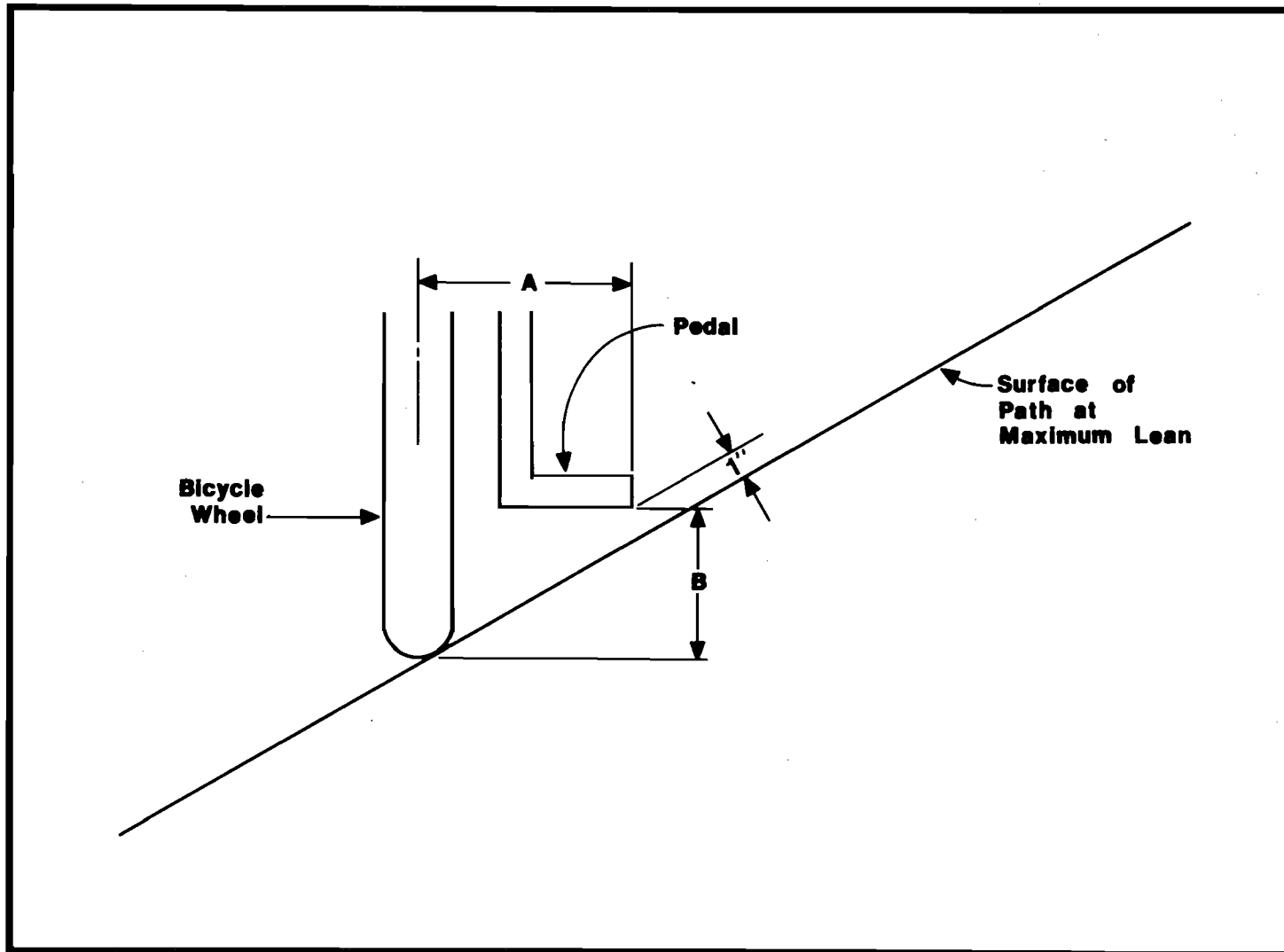

Figure B-1 ACCEPTABLE LEAN ANGLE-DESIGN BICYCLE

In communities where the riding surface may often be wet or locations where the presence of gravel or debris is expected, greater radii than the conservative figures given here are recommended.

Figure B-2 is presented as a comparison between the three radii selection methods discussed above.

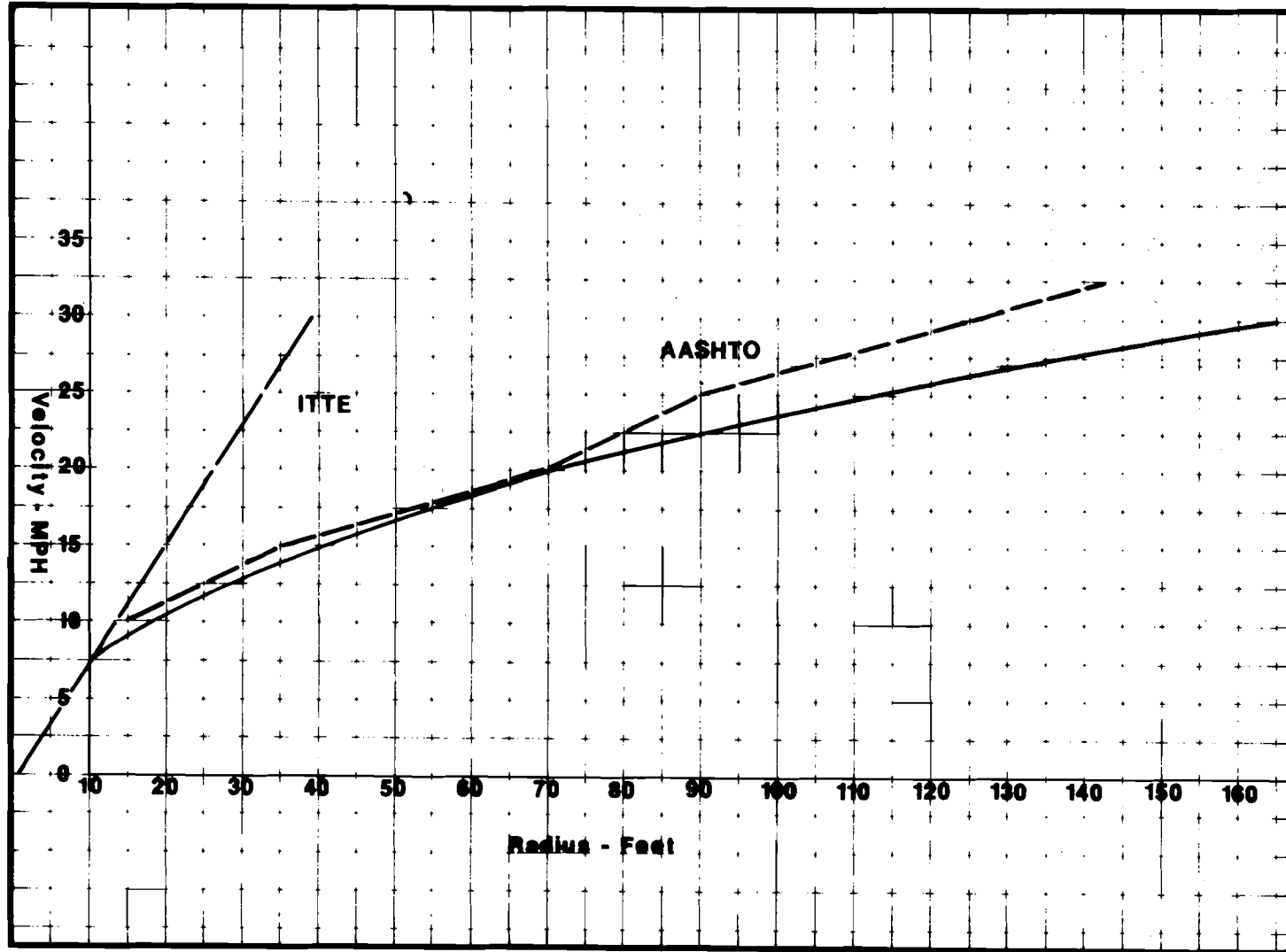

Figure B-2 COMPARISON OF RADII SELECTION CURVES

REFERENCES (APPENDIX B)

1. Institute of Transportation and Traffic Engineering, Bikeway Planning Criteria and Guidelines, University of California, Los Angeles, April, 1972, p. 31.
2. American Association of State Highway and Transportation Officials, Guide for Bicycle Routes, Washington, D.C., 1974, p. 18.
3. Institute of Traffic Engineers, Traffic Engineers Handbook, Washington, D.C., 1965, p. 610.

BIBLIOGRAPHY

Albuquerque, City of. Albuquerque/Bernalillo County Planning Department, Ad Hoc Bikeway Advisory Committee. Preliminary Report Bikeway Study. Albuquerque, New Mexico, April, 1973.

American Association of State Highway and Transportation Officials, Guide for Bicycle Routes, Washington, D.C., 1974.

American Automobile Association, Planning Criteria for Bikeways. Falls Church, Virginia, 1973.

American Automobile Association. Special Survey on Bicycle Safety. Washington; Revised November, 1972.

Atlanta Metropolitan Region. Barton-Aschman Associates Incorporated. The Bicycle. St. Paul, Minnesota, July, 1973.

_____. Technical Appendix. St. Paul, Minnesota, July, 1973.

Berkeley, City of. Berkeley Planning Department. Berkeley Bikeway Plan. Berkeley, California, Revised February, 1971.

Berryhill, James J. Planning for Bikeways. Technical Bulletin Number Two. United States Department of the Interior, Bureau of Outdoor Recreation, Southeast Regional Office. Atlanta, Georgia, July, 1974.

Bicycle Institute of America, Some Facts About The Current Bike Explosion, 1972. cited by Barton-Aschman Associates, Incorporated, The Bicycle, Atlanta Metropolitan Region, St. Paul, Minnesota, July, 1973.

"Bike Power, Bike Paths", Asphalt. January, 1974 pp. 10-11.

"Bikeway Design Provides New Challenge for Cities", The American City. May, 1973.

Buchanan, Lewis S. "The Motorcycle/Bicycle Safety Analogy". Presented at the Bicycles U.S.A. Conference, Cambridge, Massachusetts, May, 1973.

Chicago, City of. Department of Development and Planning. Guidelines for a Comprehensive Bicycle Route System. Chicago, Illinois, March, 1971.

Chlapecka, Tom, National Safety Council, U.S. Department of Transportation, "The Nature of Bicyclist Accidents and Injuries", Presentation at the Third International Congress on Automotive Safety, San Francisco, California, July 15-17, 1974.

Cook, Walter L. Bike Trails and Facilities, A Guide to Their Design Construction and Operation. American Institute of Park Executives. Published by the Bicycle Institute of America, no date.

Creighton, Roger L. Urban Transportation Planning. Urbana: University of Illinois Press, 1970.

Cross, Kenneth D. Identifying Criterial Behavior Leading to Collisions Between Bicycles and Motor Vehicles. Santa Barbara, California, no date.

DeLeuw, Cather and Company. Pleasanton Pedestrian and Bicycle Safety. San Francisco, California, July, 1972.

_____. Davis Bicycle Circulation and Safety Study. San Francisco, California, August, 1972.

Denver, City of. Denver Planning Office. The Bikeway Plan. Denver, Colorado, 1972.

Desimone, Vincent R., P.E. "Planning Criteria for Bikeways". Presented at the American Society of Civil Engineers National Transportation Engineering Meeting, Milwaukee, Wisconsin, July 17-21, 1972.

Dougherty, Nina and William Lawrence. Bicycle Transportation. U.S. Environmental Protection Agency, Office of Planning and Evaluation. Washington, December, 1974.

Everett, Michael K. "Bike-Route Planning Strategies". Unpublished Manuscript.

Ferrara, Thomas C. "A Simulation Model of Bicycles Crossing a Two-Lane Two-Way Street". Presented at the Annual Meeting of the Transportation Research Board. Washington, D.C., January, 1975.

Fink, Ira Stephen. To and From Campus: Changing Student Transportation Patterns. University of California, October, 1974.

Germano, A. Trent, and others. "The Emerging Need of Bicycle Transportation". Paper presented at the Annual Meeting of the Highway Research Board, January, 1973, Washington, D.C.

Gutkowski, Robert. "The Cycle of the Bicycle is Returning", Passages. 6/74 pp. 9-11.

Hamill, James P. "Planning and Development of Bikeway Systems", Management Information Service Report. Washington: International City Management Association, April, 1973.

Hanson, Susan and Perry Hanson. "Problems in Integrating Bicycle Travel into the Urban Transportation Planning Process". A paper presented at the Annual Meeting of the Transportation Research Board, Washington, D.C., January, 1975.

Hawaii, State of. Department of Transportation Highways Division. An Approach to Establishing Bikeways. Honolulu, Hawaii, December, 1970.

- "Honolulu's Bicycle Safety Program", Public Works, January, 1974 pp. 63-65.
- Hunt, John. Bicycle Safety Resource Guide for Middle and Junior High Schools. Seattle Public Schools. Seattle, Washington, 1975.
- Illinois, State of. Illinois Bicycle Rules of the Road. State of Illinois, April, 1971.
- Institute of Traffic Engineers, Traffic Engineers Handbook. Washington, D.C., 1965.
- Institute of Transportation and Traffic Engineering. Bikeway Planning Criteria and Guidelines. University of California, Los Angeles, April, 1972.
- "IIHS Completes Major Bicycle Study". Status Report. Insurance Institute for Highway Safety. Washington, D.C., December 10, 1974. pp.1-5.
- Jilla, Robert J. Effects of Bicycle Lanes on Traffic Flow. Purdue University, June, 1974.
- Kaplan, Jerrold A. "A Highway Safety Standard for Bicycle Facilities". Federal Highway Administration, Office of Highway Safety. Presented at the Annual Meeting of the Transportation Research Board, Washington, D.C., January, 1975.
- Kennedy, Norman, James H. Kell, and Wolfgang S. Homburger, Institute of Traffic and Transportation Engineering, Fundamentals of Traffic Engineering. University of California, Berkeley, 1962.
- King, County of. Department of Planning. A Preliminary Scenic Route System Plan. Seattle, Washington, May, 1970.
- Konski, James L. The Bicycle Anarchy. Transportation Engineering Journal ASCE, Volume 99. New York: American Society of Civil Engineers, 1973.
- _____. Report to Common Council on Bicycle Registration, Safety and Law Enforcement. Madison, Wisconsin, April, 1972.
- Kroll, Bonnie and Robert Sommer. "West Coast Bikeway Survey". Presented at the University of California, Davis Extension Bikeway Workshop, Davis, California, July, 1974.
- Madison, City of. Department of Transportation. A Total Bicycle Program for Madison. Madison, Wisconsin, January, 1972.
- McClure, James D. "Planning Design and Funding of Bike Paths". Presentation to Washington Citizen's Advisory Committee on Bicycling, Portland, Oregon, June, 1974.

McGuire, Phillip and Johnson County Regional Planning Commission. "Bicycle Planning and Development in Iowa City". Paper read at MAUDEP Pedestrian/Bicycle Planning Seminar, San Francisco, California, December, 1972.

Mercer, County of. A Report on Bicycle Facilities for Mercer County, N.J. Professional Engineers Society of Mercer County. No date.

Murphy, Jack. "The Public View". Presentation at MAUDEP Seminar on Bicycles and Pedestrian Planning, San Francisco, California, December, 1972.

Oppenlander, J.C. and J.H. Corazzini. Development of a Planning Process for a Functional and Recreational Bicycle System. University of Vermont, Burlington, Vermont, January, 1975.

Oregon, State of. Oregon State Highway Division. Bikeway Design. Salem, Oregon, January, 1974.

_____. Footpaths and Bike Routes, Standards and Guidelines. Salem, Oregon, January, 1972.

_____. Oregon Department of Transportation, Highway Division. Oregon Bikeways Progress Report. Salem, Oregon 1973.

_____. Oregon Department of Transportation, Motor Vehicles Division. Oregon Bicycle/Motor Vehicle Accidents 1973. Salem, Oregon, February, 1974.

Palo Alto, City of. "Official Bicycle Manual", No date.

Podolske, Richard C. and Carl E. Ohrn. Planning for Improved Bicycle Systems. Barton-Aschman Associates Incorporated. St. Paul, Minnesota, November, 1973.

Ramey, M.R. and R. Sommer and D.F. Lott. "Some Aspects of the Design and Evaluation of Bikeway Facilities". Paper presented at the ASCE National Transportation Engineering Meeting, Tulsa, Oklahoma, July, 1973.

San Diego, City of. City Planning Department. Transportation Element Background Study. San Diego, California, April, 1972.

Santa Barbara, City of. Public Works Department. The Proposed Bikeway Master Plan. Santa Barbara, California, May, 1974.

_____. Public Works Department. City of Santa Barbara Bikeway Planning Surveys. Santa Barbara, California, September, 1973.

Santa Clara, County of. South Bay Transportation Officials Association. Bike Route System in the County of Santa Clara. San Jose, California, April, 1972.

SB 355, State of Washington, 2nd Ex. Session (1972), Chapter 47.30 RCW.

Seattle, City of, Engineering Department, Bicycle Safety Study.
(Seattle, Washington, May, 1975).

_____. Comprehensive Bikeway Plan. Seattle, Washington, December,
1972.

Sommer, Robert and Dale F. Lott. "Behavioral Evaluation of a Bikeway System".
Unpublished Bicycle Manuscript.

Standing Committee on Engineering Operations. Guide for Bicycle Routes.
Washington: The American Association of State Highway and Transportation
Officials, 1974.

Steward, Chuck. Bicycling in Seattle. Seattle: Recreation Consultants,
1971.

Tempe, City of. Tempe Planning Department. Tempe Bikeway Study: Background.
Tempe, Arizona, 1972.

_____. Tempe Planning Department. Tempe Bikeway Study: Preliminary
Plans and Recommendations. Tempe, Arizona, March, 1973.

Thomas, Edwin N. and Joseph L. Schafer, "Strategies for the Evaluation
of Alternative Transportation Plans", HRB Hwy. Res. Report 96,
(Washington: 1970).

Title 23, U.S. Code, Section 217.

Topish, Lloyd M. and Roger B. Lytell. A Study of Bicycle - Motor Vehicle
Accidents. A Report for the City of Santa Barbara, Santa Barbara, California,
June, 1973.

University of Washington. Department of Facilities Planning and Construction.
"Bicycles on Campus". University of Washington, Seattle, Washington, October,
1971.

Urban Bikeway Design Competition, Bikeway Design Atlas, M.I.T., Cambridge,
Ma., December, 1974.

U. S. Consumer Product Safety Commission. Staff Analysis of Bicycles (1202).
May, 1973.

U.S. Department of Transportation. Office of Environmental Affairs.
BART/ TRAILS. Washington, D.C., February, 1974.

U. S. Department of Transportation. National Safety Advisory Committee.
Bicycling as a Highway Safety Problem, Summary of Preliminary Findings
and Recommendations. Washington, May, 1974.

U. S. Department of Transportation, U.S. Department of the Interior.
Bicycling for Recreation and Commuting. Washington:
Government Printing Office.

U.S. Department of Transportation, U.S. Department of the Interior.
Conference Proceedings: Bicycles U.S.A. May 7/8. 1973, Cambridge, Massachusetts.
Washington: Government Printing Office.

U.S. Federal Highway Administration, De Leuw, Cather and Company,
Bikeways - State of the Art - 1974. Washington, D.C., July, 1974.

U.S., Federal Highway Administration, Federal-Aid Highway Program Manual.
Vol. 6, Chap. 1, Sec. 1, Subsec. 1. March 8, 1974.

U.S. Federal Highway Administration, Manual on Uniform Traffic Control
Devices. Washington, November, 1970.

Washington, State of, Department of Highways, "Highway Design Manual".
April, 1974. pp. 3-30.04, 3-30.04 (1) a - 3-30.04 (2)c.

_____. Interagency Committee for Outdoor Recreation.
Washington State Recreation Trails Program. Tumwater, Washington, 1974.

"What about bike tripping?". Sunset. May, 1974.

Wheaton, Virginia. "The Boom in Bicycles", Highway User. May, 1972,
pp. 22-25.

Wilson, S.S. "Bicycle Technology", Scientific American. March, 1973,
pp. 81-91.

Wiseman, Robin. "A Bicycle Made For Who?", Surveyor. June 16, 1972,
pp. 20-21.

Wolfe, Fredrick L. "Exclusive Bike Lane Operating Experience on Denver
Streets". Paper read at the Highway Research Board's 53rd Annual Meeting,
Washington, D.C., January, 1974.

Zimmerman, Mary Ann, Chicago Department of Streets and Sanitation.
Bicycle Facilities Planning. Chicago, Illinois, April, 1973.