



# Oregon

Theodore R. Kulongoski, Governor

**Department of Land Conservation and Development**

635 Capitol Street, Suite 150

Salem, OR 97301-2540

(503) 373-0050

Fax (503) 378-5518

[www.lcd.state.or.us](http://www.lcd.state.or.us)

## NOTICE OF ADOPTED AMENDMENT

June 25, 2007



TO: Subscribers to Notice of Adopted Plan  
or Land Use Regulation Amendments

FROM: Mara Ulloa, Plan Amendment Program Specialist

SUBJECT: City of Independence Plan Amendment  
DLCD File Number 001-07

The Department of Land Conservation and Development (DLCD) received the attached notice of adoption. Copies of the adopted plan amendment are available for review at DLCD offices in Salem, the applicable field office, and at the local government office.

Appeal Procedures\*

### **DLCD ACKNOWLEDGMENT OR DEADLINE TO APPEAL: July 10, 2007**

This amendment was not submitted to DLCD for review prior to adoption. Pursuant to OAR 660-18-060, the Director or any person is eligible to appeal this action to LUBA under ORS 197.830 to 197.845.

If you wish to appeal, you must file a notice of intent to appeal with the Land Use Board of Appeals (LUBA) no later than 21 days from the date the decision was mailed to you by the local government. If you have questions, check with the local government to determine the appeal deadline. Copies of the notice of intent to appeal must be served upon the local government and others who received written notice of the final decision from the local government. The notice of intent to appeal must be served and filed in the form and manner prescribed by LUBA, (OAR Chapter 661, Division 10). Please call LUBA at 503-373-1265, if you have questions about appeal procedures.

**\*NOTE: THE APPEAL DEADLINE IS BASED UPON THE DATE THE DECISION WAS MAILED BY LOCAL GOVERNMENT. A DECISION MAY HAVE BEEN MAILED TO YOU ON A DIFFERENT DATE THAN IT WAS MAILED TO DLCD. AS A RESULT YOUR APPEAL DEADLINE MAY BE EARLIER THAN THE DATE SPECIFIED ABOVE.**

Cc: Gloria Gardiner, DLCD Urban Planning Specialist  
Jason Locke, DLCD Regional Representative  
Matthew Crall, DLCD Transportation Planner  
Bob Cortright, DLCD Transportation & Growth Management Coordinator  
Mike Danko, City of Independence

<paa>

PROP **2**

# DLCD

## Notice of Adoption

THIS FORM **MUST BE MAILED** TO DLCD  
**WITHIN 5 WORKING DAYS AFTER THE FINAL DECISION**  
PER ORS 197.610, OAR CHAPTER 660 - DIVISION 18



Jurisdiction: *Independence, OR*  
Date of Adoption: *6/12/07*

Local file number:  
Date Mailed: *6/19/07*

Was a Notice of Proposed Amendment (Form 1) mailed to DLCD? **Select one** Date:

- |  |  |
|--|--|
| <input type="checkbox"/> Comprehensive Plan Text Amendment | <input type="checkbox"/> Comprehensive Plan Map Amendment                        |
| <input type="checkbox"/> Land Use Regulation Amendment     | <input type="checkbox"/> Zoning Map Amendment                                    |
| <input type="checkbox"/> New Land Use Regulation           | <input checked="" type="checkbox"/> Other: <i>Matt Crall involved in project</i> |

Summarize the adopted amendment. Do not use technical terms. Do not write "See Attached".

*Update of the City Transportation System Plan*

Does the Adoption differ from proposal? Please select one

*No*

DEPT OF

JUN 20 2007

LAND CONSERVATION  
AND DEVELOPMENT

Plan Map Changed from: to:

Zone Map Changed from: to:

Location: Acres Involved:

Specify Density: Previous: New:

Applicable statewide planning goals:

- |                          |                          |                          |                          |                          |                          |                          |                          |                          |                          |                          |                          |                          |                          |                          |                          |                          |                          |                          |
|--------------------------|--------------------------|--------------------------|--------------------------|--------------------------|--------------------------|--------------------------|--------------------------|--------------------------|--------------------------|--------------------------|--------------------------|--------------------------|--------------------------|--------------------------|--------------------------|--------------------------|--------------------------|--------------------------|
| <b>1</b>                 | <b>2</b>                 | <b>3</b>                 | <b>4</b>                 | <b>5</b>                 | <b>6</b>                 | <b>7</b>                 | <b>8</b>                 | <b>9</b>                 | <b>10</b>                | <b>11</b>                | <b>12</b>                | <b>13</b>                | <b>14</b>                | <b>15</b>                | <b>16</b>                | <b>17</b>                | <b>18</b>                | <b>19</b>                |
| <input type="checkbox"/> | <input type="checkbox"/> | <input type="checkbox"/> | <input type="checkbox"/> | <input type="checkbox"/> | <input type="checkbox"/> | <input type="checkbox"/> | <input type="checkbox"/> | <input type="checkbox"/> | <input type="checkbox"/> | <input type="checkbox"/> | <input type="checkbox"/> | <input type="checkbox"/> | <input type="checkbox"/> | <input type="checkbox"/> | <input type="checkbox"/> | <input type="checkbox"/> | <input type="checkbox"/> | <input type="checkbox"/> |

Was an Exception Adopted?  YES  NO

Did DLCD receive a Notice of Proposed Amendment...

45-days prior to first evidentiary hearing?  Yes  No

If no, do the statewide planning goals apply?  Yes  No

If no, did Emergency Circumstances require immediate adoption?  Yes  No

DLCD file No. *001-07 (NOA)*

Please list all affected State or Federal Agencies, Local Governments or Special Districts:

City of Independence, ODOT, Dept. of Aviation, DLCD, Polk County

Local Contact: Mike Danko

Phone: (503) 838-1212 Extension: —

Address: P.O. Box 7

Fax Number: 503-606-3282

City: Independence Zip: 97351

E-mail Address: mdanko@ci.independence.or.us

### ADOPTION SUBMITTAL REQUIREMENTS

This form **must be mailed** to DLCD **within 5 working days after the final decision**

per ORS 197.610, OAR Chapter 660 - Division 18.

1. Send this Form and TWO Complete Copies (documents and maps) of the Adopted Amendment to:

**ATTENTION: PLAN AMENDMENT SPECIALIST**  
**DEPARTMENT OF LAND CONSERVATION AND DEVELOPMENT**  
**635 CAPITOL STREET NE, SUITE 150**  
**SALEM, OREGON 97301-2540**

2. Electronic Submittals: At least **one** hard copy must be sent by mail or in person, but you may also submit an electronic copy, by either email or FTP. You may connect to this address to FTP proposals and adoptions: **webserver.lcd.state.or.us**. To obtain our Username and password for FTP, call Mara Ulloa at 503-373-0050 extension 238, or by emailing **mara.ulloa@state.or.us**.
3. Please Note: Adopted materials must be sent to DLCD not later than **FIVE (5) working days** following the date of the final decision on the amendment.
4. Submittal of this Notice of Adoption must include the text of the amendment plus adopted findings and supplementary information.
5. The deadline to appeal will not be extended if you submit this notice of adoption within five working days of the final decision. Appeals to LUBA may be filed within **TWENTY-ONE (21) days** of the date, the Notice of Adoption is sent to DLCD.
6. In addition to sending the Notice of Adoption to DLCD, you must notify persons who participated in the local hearing and requested notice of the final decision.
7. **Need More Copies?** You can now access these forms online at **http://www.lcd.state.or.us/**. Please print on **8-1/2x11 green paper only**. You may also call the DLCD Office at (503) 373-0050; or Fax your request to: (503) 378-5518; or Email your request to **mara.ulloa@state.or.us** - ATTENTION: PLAN AMENDMENT SPECIALIST.

BEFORE THE CITY COUNCIL OF THE CITY OF INDEPENDENCE  
FOR THE COUNTY OF POLK, STATE OF OREGON

An Ordinance Amending Subchapters 11, 12, )  
20, 21, 22, 30, 32, 40, 41, 42 48, 50, 57, 73, 80 )  
& 90 of the Independence Development Code and ) Council Bill # 2007-02  
Stating an Effective Date )

**ORDINANCE NO. 1460**

WHEREAS, the City of Independence has been engaged in review of the City's  
Transportation System Plan (TSP); and

WHEREAS, after proper legal notice, the Independence City Council conducted a public  
hearing concerning the proposed amendments to the Development Code, reviewed its land use  
regulations and determined that amendments to the Independence Development Code (IDC)  
are necessary not only for compliance with the State of Oregon Transportation Planning Rule  
(TPR), but also to ensure consistency between the TSP and the IDC; and

WHEREAS, the council also has reviewed the record and the recommendations of staff,  
NOW THEREFORE,

THE CITY OF INDEPENDENCE DOES ORDAIN AS FOLLOWS:

Section 1. The attached Exhibit "A" is hereby adopted as amendments to Subchapters  
11, 12, 20, 21, 22, 30, 32, 40, 41, 42 48, 50, 57, 73, 80 and 90 of the Independence  
Development Code.

Section 2. The Transportation System Plan, as updated, is hereby adopted and  
attached as Exhibit "B".

Section 3. Effective Date. The Ordinance shall become effective 30 days after passage  
by the Council and signature of the Mayor.

READ for the first time: June 12, 2007  
READ for the second time: June 12, 2007  
APPROVED and SIGNED  
by the Mayor: June 12, 2007

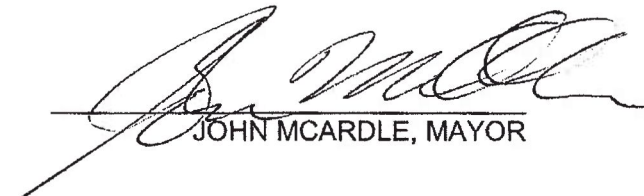
  
JOHN MCARDLE, MAYOR

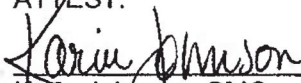
ATTEST:  
  
Karin Johnson, CMC  
City Recorder

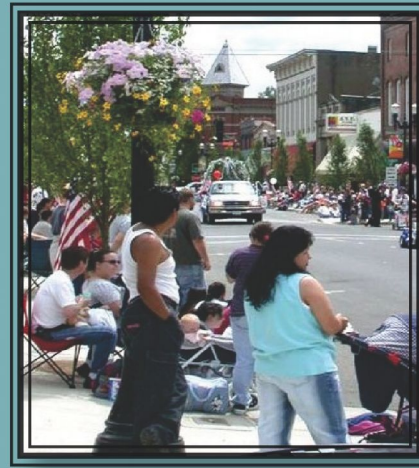
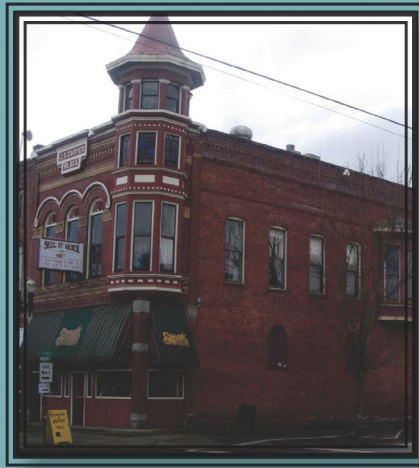
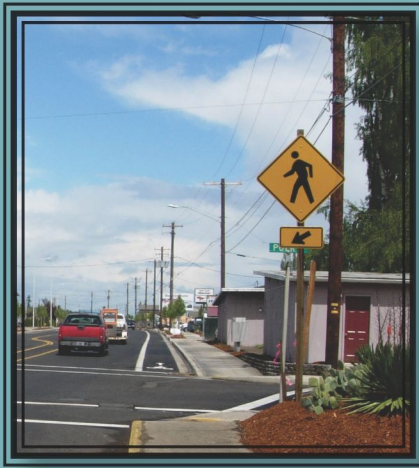

# CITY OF INDEPENDENCE TRANSPORTATION SYSTEM PLAN

Prepared for:

CITY OF INDEPENDENCE  
240 Monmouth Street  
Independence, OR 97351-2424

Prepared by:

**Parametrix**  
700 NE Multnomah Ste. 1000  
Portland, OR 97232-2131

Partially funded by:



JUNE 2007

**This page intentionally left blank.**

# City of Independence Transportation System Plan

*Prepared for*

**City of Independence**  
P.O. Box 7  
Independence, OR 97351

*Prepared by*

**Parametrix**  
700 NE Multnomah, Suite 1000  
Portland, OR 97232-4110  
503-233-2400  
[www.parametrix.com](http://www.parametrix.com)

#### CITATION

This project is partially funded by a grant from the Transportation and Growth Management (TGM) Program, a joint program of the Oregon Department of Transportation and the Oregon Department of Land Conservation and Development. This TGM grant is financed, in part, by federal Safe, Accountable, Flexible, Efficient Transportation Equity Act: A Legacy for Users (SAFETEA-LU), local government, and State of Oregon funds.

The contents of this document do not necessarily reflect views or policies of the State of Oregon.

Parametrix. 2007. City of Independence Transportation System Plan. Prepared by Parametrix, Portland, Oregon. June 2007.



## CERTIFICATION

The technical material and data contained in this document were prepared under the supervision and direction of the undersigned, whose seal, as a professional engineer licensed to practice as such, is affixed below.

  
Prepared by Shelley Oylear - EIT

  
Checked by Anne Sylvester - Senior Transportation Engineer, P.E.

  
Approved by Michael Harrison - Planner, Project Manager

**This page intentionally left blank.**

## **ACKNOWLEDGMENTS**

The following persons are acknowledged for their contributions to the development of this Transportation System Plan:

### **Technical Advisory Committee**

Matt Crall, Oregon Department of Land Conservation and Development  
Jason Locke, Oregon Department of Land Conservation and Development  
Dan Fricke, Oregon Department of Transportation, Region 2  
Dorothy Upton, Oregon Department of Transportation, TPAU  
Austin McGuigan, Polk County  
Mike Danko, City of Independence  
Shawn Irvine, City of Independence

### **City of Independence Planning Commission**

Corby Chappell, Chair  
Eric Puig, Co-Chair  
Katherine Bartlett  
Bill Nicassio  
Vidal Peña  
Andy Scott  
Tom Takacs

### **City of Independence City Council**

John McArdle, Mayor  
Tim Hinds, Councilor  
Jerry Hoffman, Councilor  
Jim Kirkendall, Councilor  
Diana Lindskog, Councilor  
Marilyn Morton, Councilor  
Nancy Lodge, Councilor

### **Technical Assistance Provided by:**

Michael Harrison, Project Manager / Planner  
Anne Sylvester, PTE, Senior Project Advisor  
Shelley Oylear, EIT, Traffic Engineering

**This page intentionally left blank.**

## TABLE OF CONTENTS

<b>1. INTRODUCTION</b> .....	<b>1-1</b>
1.1 PURPOSE OF THE TRANSPORTATION SYSTEM PLAN .....	1-1
1.2 DEVELOPMENT OF THE TRANSPORTATION SYSTEM PLAN .....	1-1
1.3 COMMUNITY DESCRIPTION AND HISTORICAL OVERVIEW .....	1-1
<b>2. TRANSPORTATION SYSTEM PLAN DEVELOPMENT</b> .....	<b>2-1</b>
2.1 REVIEW AND EVALUATION OF EXISTING PLANS, POLICIES, STANDARDS, AND LAWS .....	2-1
Federal Americans with Disabilities Act .....	2-2
Oregon Transportation Planning Rule (1991) .....	2-2
Oregon Transportation Plan (2006) .....	2-3
Oregon Aviation System Plan (2000) .....	2-3
Oregon Bicycle and Pedestrian Plan (1995) .....	2-4
Oregon Transportation Safety Action Plan (1995) .....	2-4
Oregon Public Transportation Plan (1997) .....	2-4
Oregon Highway Plan (1999) .....	2-5
Oregon Rail Freight and Passenger Plan (2001) .....	2-6
Oregon Administrative Rules Regarding Access Management (OAR 734-051) .....	2-6
Freight Moves the Oregon Economy (1999) .....	2-7
Statewide Transportation Improvement Program 2006-2009 .....	2-7
Polk County Comprehensive Plan Transportation Element (2004 Edition) .....	2-7
Polk County Transportation System Plan (1998) .....	2-8
City of Monmouth, Transportation System Plan (1997) .....	2-9
City of Independence Comprehensive Plan (2003) .....	2-9
Independence State Airport, Airport Layout Plan Report (1997) .....	2-11
Independence-Monmouth Comprehensive Master Bicycle Plan (December 1991) .....	2-11
Ash Creek Trail Master Plan (April 2005) .....	2-11
City of Independence Parks and Open Space Master Plan (1996) .....	2-11
City of Independence Goals and Objectives (2005) .....	2-12
City of Independence Strategic Plan (2002) .....	2-12
2.2 ANALYSIS OF EXISTING LAND USES .....	2-12
2.3 EXISTING TRANSPORTATION SYSTEM .....	2-13
Roadway Facilities .....	2-13
Bicycle and Pedestrian Facilities .....	2-33
Public Transit .....	2-39
Air Transportation .....	2-41
Railroad Transportation .....	2-43
Pipeline and Water Transportation .....	2-46
2.4 DEVELOPMENT AND EVALUATION OF ALTERNATIVES .....	2-46
2026 Land Development Expectations .....	2-46
Summary of Alternatives .....	2-51

Future Traffic Operations .....	2-52
<b>3. TRANSPORTATION SYSTEM PLAN .....</b>	<b>3-1</b>
3.1 TRANSPORTATION GOALS, OBJECTIVES AND POLICIES .....	3-1
3.2 ROADWAY ELEMENT.....	3-2
Summary of Street System Deficiencies .....	3-2
Roadway System Improvement.....	3-3
Beyond the 20-year TSP Planning Horizon .....	3-13
3.3 PUBLIC TRANSIT ELEMENT .....	3-13
Public Transit Policies.....	3-14
Public Transit Improvements .....	3-14
3.4 BIKEWAY SYSTEM ELEMENT .....	3-15
Bicycle Transportation System Policies.....	3-15
Bicycle Transportation System Projects.....	3-16
3.5 PEDESTRIAN SYSTEM ELEMENT .....	3-17
Pedestrian Transportation System Policies .....	3-17
Pedestrian Transportation System Projects.....	3-17
3.6 AIR, TRUCK FREIGHT, RAIL, WATER AND PIPELINE TRANSPORTATION ELEMENTS .....	3-18
Air Transportation .....	3-18
Rail Transportation.....	3-19
Truck Freight.....	3-19
Pipeline and Water Transportation .....	3-19
3.7 TRANSPORTATION SYSTEM DEMAND AND MANAGEMENT ELEMENT .....	3-20
3.8 SUMMARY OF TSP IMPROVEMENTS.....	3-20
<b>4. IMPLEMENTATION OF TRANSPORTATION SYSTEM PLAN .....</b>	<b>4-1</b>
4.1 REVIEW AND COORDINATION .....	4-1
4.2 IMPLEMENTING ORDINANCES .....	4-1
4.3 FINANCING AND CAPITAL IMPROVEMENT PROGRAM.....	4-1
Available Funding Methods .....	4-2
Potential Funding Methods .....	4-5
Recommended Funding for TSP Improvements .....	4-6

**LIST OF TABLES**

Table 2-1. Adopted Elements of the Oregon Transportation Plan.....	2-3
Table 2-2. Independence Street Design Standards.....	2-21
Table 2-3. Access Management Spacing Standards for Private and Public Approaches on District Highways <sup>(1)(2)(3)(4)</sup> (Measured in Feet)*.....	2-23
Table 2-4. Access Management Standards for City Streets.....	2-23

## TABLE OF CONTENTS (CONTINUED)

Table 2-5. Volume to Capacity Ratio Description.....	2-27
Table 2-6. Oregon 51 (Hwys 193 & 43) Peak Hour, Maximum V/C Standards.....	2-28
Table 2-7. Level of Service Definitions.....	2-29
Table 2-8. 2006 (30 HV) Operations at Key Intersections in Independence.....	2-30
Table 2-9. 2007 Survey of CARTS Ridership Characteristics.....	2-39
Table 2-10. Recommended Minimum Levels of Service.....	2-40
Table 2-11. Future (2026) Community Development Data.....	2-50
Table 2-12. 2026 No-Action Alternative, Intersection Operations Analysis.....	2-52
Table 2-13. 2026 System Improvement Alternative, Intersection Operations Analysis.....	2-54
Table 2-14. 2042 Full UGB Build-out Alternative (Without Improvements), Intersection Operations Analysis.....	2-56
Table 2-15. 2042 Full UGB Build-out Alternative (With Improvements), Intersection Operations Analysis.....	2-58
Table 3-1. Independence Street Design Standards.....	3-5
Table 3-2. Access Management Spacing Standards for Private and Public Approaches on District Highways <sup>(1)(2)(3)(4)</sup> (Measured in Feet)*.....	3-7
Table 3-3. Oregon 51 (Hwys 193 & 43) Peak Hour, Maximum V/C Standards.....	3-8
Table 3-4. Draft: 2006-2026 Transportation System Capital Improvements.....	3-20
Table 3-5. Full UGB Build Out (2042) Transportation System Capital Improvements Program*.....	3-22
Table 4-1. Summary of the City of Independence Transportation System Needs and Revenues*.....	4-2

## LIST OF FIGURES

Figure 1. Comprehensive Plan Land Use Designations.....	2-15
Figure 2. Street System Functional Classification.....	2-17
Figure 3. Oregon Highway Plan Classifications.....	2-19
Figure 4. Existing Intersection Geometry.....	2-25
Figure 5. 2006 Balanced Traffic Volumes.....	2-31
Figure 6. Existing Bicycle Facilities.....	2-35
Figure 7. Existing Pedestrian Facilities.....	2-37
Figure 8. Independence Traffic Analysis Zones.....	2-47
Figure 9. Capital Improvement Projects.....	3-11

**APPENDICES VOLUME**

APPENDIX A ..... Existing Transportation System Inventory  
APPENDIX B ..... Traffic Data and Analysis  
APPENDIX C ..... Proposed Revisions to City Code



## KEY TERMS AND ACRONYMS

Access Management	Measures regulating access to streets, roads, and highways from public streets or roads and private driveways. Measures may include, but are not limited to, restrictions on the siting of interchanges; restrictions on the type and amount of access to roadways; and the use of physical controls, such as signals and channelization to reduce impact of approaching traffic on the main facility.
ADA: Americans with Disabilities Act of 1990	Federal legislation requiring that public facilities and commercial buildings have doorways, corridors, accessways, elevators, seating, and other facilities that are accessible to the handicapped population.
ADT	Average Daily Traffic volumes
APM	Analysis Procedures Manual
Average Daily Traffic (ADT)	The annual average two-way traffic volume. It represents the total traffic for the year divided by 365.
Bikeway	A bikeway is created when a road has the appropriate design treatment for bicyclists, based on motor vehicle traffic volumes and speeds: shared roadway, shoulder bikeway, bike lane or bicycle boulevard. Another type of facility is separated from the roadway: multi-use path.
Bike Lane	A portion of the roadway which has been designated by striping and pavement markings for the preferential or exclusive use of bicyclists.
Commercial Center (CC)	Commercial Centers are encouraged to locate in a community that is the population center for the region and where the majority of the average daily trips to the center originate. Generally these centers have 400,000 square feet of gross leasable area or public buildings. These centers are intended for commercial or mixed commercial, retail and office activities. They may include public uses. The buildings are clustered with consolidated access to the state highway rather than developed along the highway with multiple accesses. Multi-family residential uses may be located within or adjacent to a center. Major metropolitan areas may have multiple Commercial Centers. The primary objective of the state highway adjacent to a Commercial Center is to maintain through traffic mobility in accordance with its function. Commercial Centers include a high level of regional accessibility and connections to the local road network. The Commercial Center accommodates pedestrian and bicycle access and circulation and, where appropriate, transit movements.

Comprehensive Plan	A local document that guides a community’s land use, conservation of natural resources, economic development, and public services. Plans contain data and information called the inventory, and the policy element. The policy element sets forth the community’s long-range objectives and the policies by which they will be achieved. The plan is adopted by ordinance and has the force of law.
Demand Management:	Actions which are designed to change travel behavior in order to improve performance of transportation facilities and to reduce need for additional road capacity. Methods may include, but are not limited to, land use changes to bring destinations closer, walking, biking, transit, ridesharing and vanpool programs, and trip reduction ordinances.
DLCD	Department of Land Conservation and Development, the State of Oregon’s land use planning agency.
Highway Segment Designations	Highway segment designations are a way of describing segments of Oregon’s highway system that have, or are encouraged to have, more compact adjacent development patterns. Highway segment designations may generally be located within urban growth boundaries and urban unincorporated communities on District, Regional or Statewide Highways that are not on Interstate Highways or Expressways. Highway segment designations may change the applicable Oregon Department of Transportation design standards, mobility standards and access management spacing standards within the segment. Specific highway segment designations include Special Transportation Areas (STAs), Urban Business Areas (UBAs), and Commercial Centers (CCs).
Intermodal	Connecting individual modes of transportation and /or accommodating transfers between such modes.
LOS	Level of Service, a qualitative measure of the effect of a number of factors on transportation service including speed and travel time, traffic interruptions, freedom of movement, safety, driving comfort, and convenience. LOS is typically expressed using letter grades from A through F.
Mobility	Being able to move easily from place to place.
Modes of Transportation	Mass transit, air, water, pipeline, rail, highways, bicycle, pedestrian types of travel and transport. The terms “modes,” “mode connectivity,” and intermodal refer to these types of travel.
MPO	Metropolitan Planning Organization
Multimodal	Involving several modes of transportation.

## KEY TERMS AND ACRONYMS (CONTINUED)

Paratransit	A general term for various types of transit service which differ (in one or more ways) from the standard fixed-route, large-bus service usually provided by transit agencies. Examples include demand-response and contracted fixed route service, among others. Paratransit services usually use smaller vehicles, such as vans, taxicabs, or small buses.
Public Transit	Bus, van, light rail and other surface transportation systems open to the general public which operate frequently and on predetermined routes and schedules.
OAR	Oregon Administrative Rules. A body of law that describes how legislation and other laws will be implemented.
ODOT	Oregon Department of Transportation
OHP	Oregon Highway Plan
RPZ	Runway Protection Zone
Rural	Any area not included in a business, industrial, or residential zone of moderate or high density, whether or not it is within the boundaries of a municipality. Also may refer to any area outside of an Urban Growth Boundary (UGB).
SAFETEA-LU	Safe, Accountable, Flexible, Efficient Transportation Equity Act: A Legacy for Users (2005), authorizing legislation for federal funding of transportation system improvements.
Shared Roadway Bikeway	A type of bikeway where bicyclists and motor vehicles share a travel lane.
Shoulder Bikeway	A type of bikeway where bicyclists travel on a paved shoulder.
SPIS	Safety Priority Index System
Special Transportation Area (STA)	A designated district of compact development located on a state highway within an urban growth boundary in which the need for appropriate local access outweighs the considerations of highway mobility except on designated OHP Freight Routes where through highway mobility has greater importance. While traffic moves through an STA and automobiles may play an important role in accessing an STA, convenience of movement within an STA is focused upon pedestrian, bicycle and transit modes. STAs look like traditional “Main Streets” and are generally located on both sides of a state highway. The primary objective of an STA is to provide access to and circulation amongst community activities, businesses and residences and to accommodate pedestrian, bicycle and transit movement along and across the highway. Direct street connections and shared on-street parking are encouraged. Local auto, pedestrian, bicycle and transit movements to the area are generally as important as the through movement of traffic. Traffic speeds are slow, generally 25 miles per hour or lower.

TAZ	Traffic Analysis Zone, a relatively homogeneous geographic area for which demographic, socio-economic and land use data is aggregated for use in travel demand forecasting.
TGM	Transportation and Growth Management, a joint program of the Oregon Department of Transportation and the Department of Land Conservation and Development to support integrated planning for transportation and land use.
Transportation Disadvantaged	Individuals who have difficulty in obtaining transportation because of their age, income, physical or mental disability. (Oregon Statewide Planning Goal 12)
TPR	The Transportation Planning Rule contained in Oregon's Administrative Rule, Chapter 660, Division 12, which implements the statewide planning Goal 12: Transportation.
Urban Business Area (UBA)	An Urban Business Area is a highway segment designation that may be applied to existing areas of commercial activity or future nodes or various types of centers of commercial activity within urban growth boundaries or urban unincorporated community boundaries on District, Regional or Statewide Highways where vehicular accessibility is important to continued economic viability. Highways that have posted speeds of 35 miles per hour or less are permitted access spacing standards that reflect the dual objectives of providing local access to meet the needs of abutting properties while maintaining existing speeds to move through traffic. For highways posted greater than 35 miles per hour, the UBA designation is available as recognition that vehicular accessibility and circulation are often as important as pedestrian, bicycle and transit accessibility, but a management plan is required to ensure that these objectives are balanced. Safe and regular street connections are encouraged. Transit turnouts, sidewalks and bicycle lanes are accommodated.
UGB	Urban Growth Boundary. A line drawn around a geographic area which separates urban use lands from resource, or rural, use lands; and shows where the City intends to grow.
Urban	Any territory within an incorporated area or with frontage on a highway which is at least 50 percent built-up with structures devoted to business, industry, or residences for a distance of a quarter mile or more. Also can refer to any area within an Urban Growth Boundary (UGB).
V/C	Volume-to-Capacity (ratio)
VMT	Vehicle Miles of Travel

## **1. INTRODUCTION**

### **1.1 PURPOSE OF THE TRANSPORTATION SYSTEM PLAN**

The *Independence Transportation System Plan (TSP)* establishes the City's goals, policies and action strategies for developing and improving the transportation system within the Independence Urban Growth Boundary. The Independence TSP outlines a twenty-year plan to guide transportation improvements and to enhance general mobility throughout this city of over 7,000 residents. The TSP is intended to serve as a blueprint or master plan to guide transportation decisions to address both short and long term needs over the coming decades.

### **1.2 DEVELOPMENT OF THE TRANSPORTATION SYSTEM PLAN**

The 2007 update of the Independence TSP began with an assessment of existing land use and elements of the transportation system, and included a review of the relevant City, county, state, and federal plans and policies. Transportation issues and community concerns were identified by the Technical Advisory Committee (TAC) and were supplemented by discussions with local school district officials, fire and emergency service responders, and police. Two public meetings were conducted to provide Independence citizens opportunities to comment on community transportation concerns and goals with respect to the City's future transportation system. The primary focus of the first public meeting was on the existing and potential future development patterns and transportation issues. The primary focus of the second public meeting was on the transportation projects necessary to address future transportation needs.

An inventory of the existing transportation system was conducted to develop an understanding of the physical, operational, traffic safety, and travel characteristics of all of the major roadways and the existing bicycle and pedestrian systems in the study area, as well as characteristics of the existing public transportation system.

The TSP addresses transportation issues and needs for the entire Independence urban growth boundary (UGB) and includes both incorporated and unincorporated areas. Development of the existing roadway system in the Independence urban area has been significantly influenced by surrounding topographical constraints. Furthermore, the state highway system comprises the only major arterial street serving the urban area. Within the study area, roadways are classified as arterial, collector, or local.

### **1.3 COMMUNITY DESCRIPTION AND HISTORICAL OVERVIEW**

The City of Independence is located in Polk County, in the central part of the Willamette Valley. Independence is located on relatively flat terrace and floodplain areas between the Forks of the Ash Creek and the Willamette River. The City is located on the west bank of the Willamette River and immediately east of Monmouth, Oregon. Salem, the capital of Oregon, is located about 10 miles to the northeast of Independence.

The town was named after Independence, Missouri, and was established on a Donation Land Claim in 1846. A brief summary of Independence's history (Morrison and Pinger, 1985), with a focus on the role and type of transportation, illustrates that the location and prosperity of the town owes much to its function as a central shipping point for the Willamette Valley. This functional history is reflected in the transportation facilities currently present in Independence and illustrates the importance of an efficient transportation system to a community. The change in dominant transportation modes over time is also illustrated by Independence's experience.

E.A. Thorp platted “Old Town” on his Donation Land Claim located north of Ash Creek. A large flood on the Willamette River in 1861 devastated the town and encouraged development of a second core area south of Ash Creek. Henry Hill platted this portion of Independence in 1867. In 1885, “Old Town” and “New Town” were incorporated. Although the “towns” were laid out on similar grid patterns, streets north and south of Ash Creek are slightly misaligned due to a bend in the Willamette River which causes the plats to be offset.

In its early years, Independence served as an important central shipping point on the Willamette River. During this time the river was used to transport foodstuffs and materials out of the Willamette Valley to gold miners in California. Goods were taken from warehouses and docks in Independence, located at River Mile 95.5 (upstream of the confluence with the Columbia River) and shipped by steamboat to Portland. A ferry across the Willamette River was built at Independence in 1885.

The railroad first came to Independence in 1886 and rail freight gradually replaced commercial shipping on the river. The City Council gave the Oregon-Western Railroad right-of-way located in the middle of 2<sup>nd</sup> Street in 1879 and daily rail service to Portland and points south was soon available. These tracks are still used today, though under a different operator. Connecting stage service to Dallas, Salem, Airlie, and King’s Valley existed.

Eventually, two other railroads were built through Independence. One line extended into Monmouth and the stop at a racetrack in the little community of Talmadge was a popular feature. This line was discontinued in 1917 and Oregon 51 was built on the route. The Valley & Siletz Railroad was operating by 1918. This line was originally constructed to haul timber salvaged from a burned area in the Coast Range to mills and other shipping points. Later, the line transported passengers and hops, as well as lumber. The railroad shipped logs to as many as three mills in Independence before it was discontinued in 1982 or 1983.

The advent of the automobile signified another change in the dominant transportation mode which continues to make its mark on Independence. In 1907, a doctor became the first car owner in town. The Oregon “Good Road Movement” promoted improvements to the existing dirt roads in the Willamette Valley and six streets in Independence were paved by 1912. A bridge over Ash Creek was widened to accommodate cars in 1909 and updated again in 1915.

Historically, the agriculture and forest products industries have been the mainstays of the local economy. From the 1890s through the 1940s the economy of Independence was dominated by a particular commodity - hops. The transportation system had to accommodate the annual shipment of thousands of hop bales and the conveyance of up to 25,000 hop pickers in and out of the area during the late summer months. Hops no longer dominate local agricultural production, but they helped to build a prosperous central business district in Independence. This cluster of brick buildings, as well as other structures, constitutes Independence’s Historical District.

The only bridge spanning the Willamette River between Salem and Albany (a distance of about 22 miles), is located at Independence. This bridge was built in 1947 and connects to South River Road in Marion County. South River Road runs along the east side of the Willamette River into Salem. Buena Vista ferry crosses the Willamette River and is located about 5 miles south of Independence at about River Mile 106.3.

Local air and public transit travel modes are relative latecomers to Independence. The journey over the Oregon Trail was reenacted as a part of the Oregon Centennial celebration in 1959. The ceremonial trek began in Independence, Missouri and ended in Independence, Oregon. The airport was built to provide air travel services for this celebration. The Independence State Airport was officially dedicated in 1964. A public bus system operated between Independence, Monmouth, Dallas, and Salem in the 1970s.

## 2. TRANSPORTATION SYSTEM PLAN DEVELOPMENT

This chapter provides an overview of the planning process undertaken to prepare the *Independence Transportation System Plan*. Included in the chapter are the following:

- **A review and evaluation of existing plans, policies, standards and laws** that are relevant to the development of a transportation plan for the Independence UGB. This review was intended to ensure that the City's TSP reflects and is consistent with state transportation planning policies and standards, and is coordinated with the plans of Polk County and the City of Monmouth. In this chapter, transportation planning requirements as articulated by the State of Oregon's Transportation Planning Rule (TPR) and other statewide transportation planning documents and programs are first summarized, followed by an overview of existing transportation plans and policies from the County and its cities.
- **An examination of existing land uses** to identify current development patterns that influence the use of today's transportation system and lay the foundation for future community growth.
- **An analysis of the existing transportation system** including an inventory and evaluation to identify opportunities and constraints and to provide the basis for developing improvement recommendations. The transportation system inventory and assessment includes:
  - Existing street characteristics, including physical features, traffic control and current traffic operations, with primary emphasis on the arterial and collector street systems
  - Bicycle and pedestrian facilities
  - Public transportation focused on local fixed route and paratransit bus service
  - Air transportation
  - Rail transportation
  - Freight transportation systems including trucking, pipeline and water transportation (there is no water-based transportation in Independence)
- **Future projections, development and evaluation of alternatives**, including the identification of traffic implications related to future community development, and an assessment of options for improving the transportation system to accommodate anticipated traffic growth.

### 2.1 REVIEW AND EVALUATION OF EXISTING PLANS, POLICIES, STANDARDS, AND LAWS

The purpose of this section is to identify and review existing plans, policies and programs that were considered in the preparation of the *Independence TSP*. A variety of transportation studies, transportation plans, and other transportation-related documents have been produced in the past. The relevance of each of these documents in relation to the preparation of the Independence TSP varies widely. This chapter provides a synopsis of the following documents:

- Federal Americans with Disabilities Act;
- Oregon Transportation Planning Rule (TPR);
- Oregon Transportation Plan (OTP) including all state modal plans;
- Oregon Administrative Rules (OAR) regarding access management;

- Freight Moves the Oregon Economy Report;
- Statewide Transportation Improvement Program (STIP) 2006-2009;
- Polk County Comprehensive Plan Transportation Element;
- Polk County Transportation System Plan;
- Monmouth Transportation System Plan;
- Independence Comprehensive Plan;
- Independence State Airport, Airport Layout Plan Report;
- Independence-Monmouth Comprehensive Master Bicycle Plan;
- Ash Creek Trail Master Plan;
- Independence Parks and Open Space Master Plan;
- Independence Goals And Objectives; and
- Independence Strategic Plan.

### **Federal Americans with Disabilities Act**

The Federal Americans with Disabilities Act (ADA) and its implementing regulations lay out guidance for the development of pedestrian facilities within public rights-of-way that are “readily accessible to and usable by people who have disabilities.” These regulations apply to all facilities constructed or altered after January 26, 1992, and include sidewalks, street crossings and other elements of the public rights-of-way. The technical provisions of the regulations describe the characteristics of an accessible element, such as the slope of a curb ramp, the turning space required at a landing, mounting heights for operating hardware (such as pedestrian push buttons for a signal), and other features.

In November 2005, the federal Access Board issued new guidelines for public rights-of-way that will address accessibility issues in greater detail than previous guidance. Included are such issues as access for blind pedestrians at street crossings, wheelchair access to on-street parking, and various constraints posed by space limitations, roadway design practices, slope, and terrain. The new guidelines will cover pedestrian access to sidewalks and streets, including crosswalks, curb ramps, street furnishings, and pedestrian signals (including provision for disabled pedestrian crossings at roundabouts, parking, and other components of public rights-of-way). The Access Board developed these draft guidelines based on recommendations from an advisory committee it had chartered. The Public Rights-of-Way Access Advisory Committee was comprised of representatives from disability organizations, public works departments, transportation and traffic engineering groups, the design and civil engineering professions, government agencies, and standards-setting bodies. The draft guidelines were revised in January 2006 and are currently undergoing additional review and comment.

### **Oregon Transportation Planning Rule (1991)**

As applicable to the City of Independence, the Oregon Transportation Planning Rule (TPR) requires local jurisdictions to develop a TSP to accommodate future travel demand resulting from adopted land use. The plan must accommodate all travel modes in use within the City, be consistent with the Oregon Transportation Plan (OTP), and coordinated with federal, state and local agencies, as well as various transportation providers.

In brief, TPR requires every local TSP to assess existing facilities for their adequacy and deficiencies; develop and evaluate system alternatives needed to accommodate land uses in the acknowledged comprehensive plan; and adopt local land use regulations to support



implementation of the preferred alternative. The City TSP must also ensure its functional classification system is consistent or compatible with those applying to facilities maintained by adjacent jurisdictions.

### Oregon Transportation Plan (2006)

The Oregon Department of Transportation (ODOT) utilizes several planning documents to guide transportation planning efforts and transportation system improvements in the state. The OTP is ODOT's overall policy guiding document. The OTP and its modal elements represent the state's TSP and drive all transportation planning in Oregon. The plans provide a framework for cooperation between ODOT and local jurisdictions and offer guidance to cities and counties for developing local modal plans. The following table lists the different modal plans that have been established and the year the plan was adopted by the Oregon Transportation Commission (OTC).

**Table 2-1. Adopted Elements of the Oregon Transportation Plan**

Oregon Transportation Plan or Plan Element	Year Adopted
Aviation System Plan	2000
Bicycle and Pedestrian Plan	1995
Transportation Safety Action Plan	1995
Public Transportation Plan	1997
Highway Plan	1999 with subsequent amendments
Rail Freight and Passenger Plan	2001

The OTC originally adopted the OTP in September 1992, and an update of the OTP was adopted by the OTC in September 2006. The OTP has three elements: (1) Goals and Policies; (2) Transportation System; and (3) Implementation. The OTP meets a legal requirement that the OTC develop and maintain a plan for a multimodal transportation system for Oregon. Further, the OTP implements the Federal Safe, Accountable, Flexible, Efficient Transportation Equity Act: A Legacy for Users (SAFETEA-LU, 2005) requirements for the state transportation plan. The OTP also meets land use planning requirements for state agency coordination and the Goal 12 Transportation Planning Rule. This rule requires ODOT, the cities, and the counties of Oregon to cooperatively plan and develop balanced transportation systems.

### Oregon Aviation System Plan (2000)

The Aviation System Plan provides forecasts and inventories for public access airports in the state. Given expected population growth in the Willamette Valley, the Plan identifies a need to protect and invest in the existing air transportation network. Some of the Plan's Policies and Actions relevant to the Independence TSP include:

**Policy 2.1.** Guide local jurisdictions in implementing the land use and zoning requirements regarding airports contained in Oregon Revised Statute (ORS) 836.600 to 836.630 and in OAR Chapter 660 Division 13.

**Policy 2.2.** Revise, adopt, and implement the state-level Oregon Airport Land Use Compatibility Guidelines, November 1994, to help local jurisdictions establish zoning and land use regulations that preserve airports and avoid future land use conflicts.

**Policy 2.3.** Guide local jurisdictions to develop appropriate zoning as required by the Oregon Department of Land Conservation and Development (DLCD) rules to keep runway protection zones (RPZ) free of all structures.

**Policy 5.2.** Develop a comprehensive approach to airport ground access as part of local and regional transportation system plans, of corridor planning, and of modal planning.

**Policy 5.3.** Provide information to airport owners on highway and other surface mode planning and programming efforts affecting airports.

**Policy 5.4.** Encourage and support the integration of airports into local corridor and regional planning.

**Policy 6.3.** Coordinate with local jurisdictions to ensure that compatible land use is implemented within appropriate distances from airports.

The Plan also includes a matrix of airport deficiencies. The matrix includes nine deficiencies for the Independence State Airport, including deficient length and width for the primary runway.

### **Oregon Bicycle and Pedestrian Plan (1995)**

The Oregon Bicycle and Pedestrian Plan (OBPP) provides guidance for planning, design and operation of facilities for bicycle and pedestrian travel. This Plan is divided into two sections, Policy & Action, and Planning, Design, Maintenance & Safety. Section One, Policy & Action, provides background information and addresses the goals, actions, and implementation strategies ODOT proposes to improve bicycle and pedestrian transportation. Section Two, Bikeway & Walkway Planning, Design, Maintenance & Safety, provides guidelines to ODOT, cities and counties in designing, constructing and maintaining pedestrian and bicycle facilities. The Oregon Bicycle and Pedestrian Plan is often used by local governments as a guide for the planning and design of facilities for these travel modes. The 2003 Highway Design Manual (HDM) also contains sidewalk and bicycle lane standards that are inconsistent, and in some cases more stringent, than those found in the 1995 OBPP. An update of the OBPP is currently underway and is expected to be completed in 2007. This update will modify the standards in the OBPP to bring them into consistency with the HDM.

### **Oregon Transportation Safety Action Plan (1995)**

This plan established the safety priorities for Oregon by identifying 70 actions relating to all modes of transportation and the roadway, driver and vehicle aspects. Included in this plan is a specific action regarding the way safety issues should be considered in local transportation planning.

Local transportation plans, as well as modal and corridor plans should consider the following:

- Involvement in the planning process of engineering, enforcement, and emergency service personnel as well as local transportation safety groups;
- Safety objectives; and
- Resolution of goal conflicts between safety and other issues.

### **Oregon Public Transportation Plan (1997)**

The plan is primarily focused on public transportation in metropolitan and urban areas. The minimum public transportation level of service standards (LOS) for communities with a population of at least 2,500 located within 20 miles of an urban central city that will apply to Independence by 2015 are as follows:

- Coordinate intercity senior and disabled services with intercity bus and van services open to the general public;
- Coordinate local public transportation and senior and disabled services to intercity bus services;
- Provide an accessible ride to anyone requesting services;
- Provide at least 1.7 annual hours of public transportation service per capita with fixed-route, dial-a-ride or other service types;
- Provide at least one accessible vehicle for every 40 hours of service;
- Provide backup vehicle for every 3.5 vehicles;
- Provide daily peak hour commuter service to the core areas of the central city;
- Provide a guaranteed ride home program to all users of the public transportation system and publicize it well;
- Provide park and ride facilities along transit route corridors to meet reasonable peak and off-peak demand for such facilities;
- Maintain vehicles and corresponding facilities in a cost-effective manner and replace vehicles when they reach suggested retirement age;
- Establish ridematching and demand management programs in communities of 5,000 where there are employers with 500 or more workers who are not already covered by a regional ridematching/demand management program; and
- Establish ridematching and demand management programs in communities of 10,000.

In addition to intracity public transportation, the plan also describes minimum LOS standards for intercity bus and passenger rail.

### **Oregon Highway Plan (1999)**

This plan defines policies and investment strategies for Oregon's state highways for the next 20 years. It further refines the goals and policies of the OTP and is part of Oregon's Statewide Transportation Plan. The Oregon Highway Plan (OHP) has three main elements:

- The Vision presents a vision for the future of the state highway system, describes economic and demographic trends in Oregon, describes future transportation technologies, summarizes the policy and legal context of the Highway Plan, and contains information on the current highway system;
- The Policy Element contains goals, policies, and actions in five policy areas: system definition, system management, access management, travel alternatives, and environmental and scenic resources; and
- The System Element contains an analysis of state highway needs, revenue forecasts, descriptions of investment strategies, implementation strategy, and performance measures.

The Highway Plan gives policy and investment direction to corridor plans and transportation system plans that are being prepared around the state, but it leaves the responsibility for identifying specific projects and modal alternatives to these plans.

Specifically relevant to the Independence area are the Highway Plan traffic operational and access management standards that apply to Oregon 51.

### **Oregon Rail Freight and Passenger Plan (2001)**

This plan presents an overview of the rail system in Oregon. It outlines the state rail planning process and examines specific rail lines in detail that may be eligible for state or federal financial assistance. The plan examines the trend of service on low-density rail lines increasingly provided by the short haul (Class III) railroads. In addition, the plan describes minimum LOS standards for freight and passenger rail systems in Oregon. The previously adopted Passenger Policy and Plan (1994) is now a component of the Oregon Rail Freight and Passenger Plan.

Relative to the Independence area, this plan describes use patterns of the Willamette & Pacific Railroad (doing business as the Portland & Western Railroad) that runs through Independence. There is also an abandoned railroad right-of-way in southwestern Independence. Passenger rail service is not presently available in Independence.

In 1994, OTC adopted four policies relating to freight service that are especially relevant to the *Independence TSP*.

**Policy 3:** Protect abandoned rights-of-way for alternative or future use.

#### **Actions**

1. Ensure that political jurisdictions and private groups are familiar with how to preserve and convert abandoned rail rights-of-way for Public Use and Interim Trail Use, as allowed under federal law.
2. Use federal, state and local funds to preserve rail rights-of-way for future transportation purposes.

**Policy 4:** Integrate rail freight considerations into the state's land use planning process.

#### **Actions**

1. Work with communities to minimize conflicts between railroad operations and other urban activities.
2. Assist in removing constraints to improved railroad operating efficiency within urbanized areas. Work with communities to consolidate or close existing grade crossings and prevent the establishment of unjustifiable new grade crossings.

### **Oregon Administrative Rules Regarding Access Management (OAR 734-051)**

ODOT manages access to the highway facilities of the state to the degree necessary to maintain functional use, highway safety, and the preservation of public investment consistent with the 1999 OHP and adopted local comprehensive plans. The purpose of Oregon's Access Management Rules is to govern the issuing of construction, operation, maintenance and use permits for approaches onto state highways, state highway rights-of-way and properties under the state's jurisdiction. These rules also govern closure of existing approaches, spacing standards, medians, variances to the standards, appeal processes, and grants of access.

Through these rules, the state indicates its policy to manage the location, spacing and type of road and street intersections and approaches on state highways to assure the safe and efficient operation of state highways consistent with their classification, and the designation of the particular highway segment. OAR 734-051 contains policies and standards regulating access, and generally holds that access control should be considered where beneficial, such as when:

- Protecting resource lands;
- Preserving highway capacity on land adjacent to an urban growth boundary (UGB); or
- Ensuring safety on segments with sharp curves, steep grades or restricted sight distance or those with a history of accidents.

Legal and policy guidelines for access are also covered in the ORS 374, the OHP, and the OTP. Oregon's access management rules and standards apply to Oregon 51 in Independence.

### **Freight Moves the Oregon Economy (1999)**

This publication succinctly states that "freight plays a major role in moving the Oregon economy. Most freight moves by truck, rail, waterway, air, and pipeline with trucks accounting for the greatest volume." Though the City of Independence is not on the State Highway Freight System, the City of Independence has one highway on the National Highway System, Oregon 51, and one freight rail line. This publication indicates that those highways not on the State Highway Freight System have common problems, including: congestion; access; pavement in poor condition; and inadequate bridges. It also notes that freight haulers experience congestion related problems, including difficulty making turning movements between local roads and highways.

### **Statewide Transportation Improvement Program 2006-2009**

Oregon's STIP is the state's transportation capital improvement program, which fulfills the requirements of the federal Safe, Accountable, Flexible, Efficient, Transportation Equity Act: a Legacy for Users (2005). The STIP lists the schedule of transportation projects for the four-year period from 2006 to 2009. It is a compilation of projects utilizing various federal and state funding programs, and includes projects on the state, county and City transportation systems as well as projects in the National Parks, National Forests, and Indian Reservations. There are no improvement projects programmed in the 2006-2009 STIP for the Independence Urban area, and only two projects near Independence:

- Willamette River/Riverside Road Bridge – Scour Protection/Prevention (this project is underway)
- North Fork Ash Creek (Riddell Road) Bridge – Replace bridge

The STIP is not a planning document; it is a project prioritization and scheduling document developed through various planning processes involving local and regional governments, transportation agencies, and the interested public. Through the STIP, ODOT allocates resources to those projects that have been given the highest priority in these plans.

### **Polk County Comprehensive Plan Transportation Element (2004 Edition)**

The Comprehensive Plan for Polk County establishes the official goals and policies related to future development in the County. These goals and policies are divided into fourteen subject areas:

1. Citizen involvement
2. Agricultural lands
3. Forest lands
4. Natural resources
5. Willamette Greenway
6. Land capability and resource quality

7. Recreational needs
8. Economic development
9. Unincorporated Communities Plan Element
10. Public facilities and services
11. Urban land development
12. Housing
13. Transportation
14. Energy conservation

Per Polk County Ordinance 98-5, the Polk County Transportation System Plan (TSP) is the Transportation Element of the County's Comprehensive Plan.

### **Polk County Transportation System Plan (1998)**

The Polk County Transportation System Plan was adopted by the Polk County Board of Commissioners on July 7, 1998. The Polk County TSP is a multimodal transportation plan that includes automobile, bicycle, rail, transit, air, walking, and transmission systems (for example, pipelines). Per Polk County Ordinance 98-5, the Polk County TSP also serves as the Transportation Element of the County's Comprehensive Plan. The following TSP goals and policies have special bearing on the Independence TSP.

#### **Goal 1**

To provide a convenient, economic, energy efficient, reliable, and safe multimodal (road, rail, air, public transportation, waterway, bicycle, pedestrian and pipeline) transportation systems for all users; including the young, elderly, disabled, and the disadvantaged.

**Policy 1-1.** Polk County will consider the road network as an important and valuable component of the transportation system.

**Policy 1-2.** Polk County will cooperate with the cities of Independence and Monmouth in preventing the construction of structures which intrude into the airspace necessary for the safe operation of aircraft using the Independence State Airport and in preventing uses of the land in the vicinity of the airport which would conflict with noise generated by the aircraft.

**Policy 1-3.** Polk County will discourage direct access from adjacent properties onto those highways designated as arterials whenever alternative access can be made available.

**Policy 1-5.** Polk County shall discourage adding mileage to the system until the following criteria are satisfied:

- The condition of the road proposed for acceptance into the system meets the county road standards; or
- An overall increase in efficiency in the county road network can be demonstrated.

**Policy 1-6.** Polk County shall explore options to reduce road mileage under the county's jurisdiction by working with the cities in Polk County to transfer the jurisdiction of county roads for maintenance and improvement when urbanization occurs. This will occur when the road functions as a City street and/or when the urban type development makes it apparent that City forces are better equipped to do the work.

**Policy 1-7.** Polk County will strive to maintain a Level of Service (LOS) A on all county arterials and collectors, and will initiate corrective action to prevent degradation below LOS

C. LOS C is a range of stable flow, but with delays at signalized or stop sign controlled intersections.

**Policy 1-9.** Polk County does not currently designate any truck routes; however, any load limited bridges or roads may prevent trucks from using some routes from time to time. The county will periodically review the need for designating routings.

**Policy 1-11.** Polk County will work with private companies and public agencies to establish an economically feasible public transportation system appropriate to the needs of its citizens, including the disadvantaged and disabled.

**Policy 1-12.** Polk County will use every practical opportunity to enhance the intermodal connectivity of its transportation system.

**Policy 1-13.** All county bicycle facilities shall be constructed in accordance with county bicycle standards.

### **Goal 2**

To maintain an ongoing transportation planning process keyed to meet the needs of the traveling public and coordinated among the state, regional, and local jurisdictions.

**Policy 2-1.** Polk County will continue to coordinate transportation planning with and consider the needs of its cities, other counties, the region, and the state. The county will support the transportation planning efforts of all its municipalities.

### **Goal 3**

To maintain a transportation system supportive of a sustained, geographically distributed and diversified economy.

**Policy 3-3.** Polk County will resist the abandonment of active railroad lines which contribute to the economic viability of the county.

**Policy 3-5.** Polk County encourages and supports the improvement of rail conditions to maintain rail service as an effective mover of goods. Concurrently, the county supports safety improvements at rail crossings.

### **Goal 4**

To implement a level of transportation development which positively contributes to Polk County's livability.

**Policy 4-1.** Polk County will require setbacks from the public right-of-way of principal arterials (such as Oregon 51) for commercial and industrial uses along such facilities.

### **City of Monmouth, Transportation System Plan (1997)**

The City of Monmouth TSP was adopted in 1997. Given the proximity of Monmouth to Independence, the Monmouth TSP roadway system improvement recommendations map was reviewed for consistency with the proposed roadway system improvement recommendations identified in this City of Independence TSP update.

### **City of Independence Comprehensive Plan (2003)**

The City of Independence Comprehensive Plan was created in 1979 and updated/amended in 1988, 1993, 2001, and 2003. The purpose of the Comprehensive Plan is to provide for orderly growth and to encourage development of a community that meets the needs of its current and

future residents. The Comprehensive Plan is the City's highest tier policy document, and establishes the policy framework for future growth decisions.

The Comprehensive Plan Goals relevant to the Independence TSP include the following.

**Goal: Economy**

To provide for and maintain a viable and diverse economy while preserving the present sense of community and high level of environmental quality.

**Policies:**

4. The City of Independence shall encourage new commercial and industrial development to provide for pedestrian and bicycle traffic, and shall be attractively landscaped.
12. The City of Independence shall develop standards in the Zoning Ordinance to encourage or require, with development or redevelopment, the consolidation of vehicle accesses on arterial streets, where appropriate and practical.

**Goal: Transportation**

To provide and encourage a safe, convenient and economic transportation system.

**Policies:**

1. Independence shall develop a coordinated street network which facilitates the mobility and accessibility of community residents.
2. Independence shall consider access to public transit in making deliberations on residential development patterns.
3. Independence shall promote the development and maintenance of alternative transportation modes, such as bikeways, pedestrian ways, and public transit.
4. Independence shall encourage transportation modes which are energy efficient and enhance the air, noise, and visual environment of the community.
5. Independence shall promote a regional mass transportation system in its planning efforts.
6. Independence shall promote and give high priority to pedestrian ways in the downtown area.
7. Independence shall encourage additional use and development of air and rail facilities in the City.

**Goal: Energy Conservation**

To conserve energy.

**Policies:**

3. Independence shall encourage energy efficient transportation alternatives to the private auto.

The Comprehensive Plan also includes Functional Street Classifications and Street Design Standards for Independence, though the Independence TSP and Development Code are the actual working guidelines for the development of new, or modifications to existing, rights-of-way.

Lastly, the Comprehensive Plan includes discussion of the transportation related infrastructure and needs as assessed in 1979 and 1988 (much of this information is now dated).



### **Independence State Airport, Airport Layout Plan Report (1997)**

Owned by the State of Oregon, the Independence State Airport is the only publicly-owned airport in Polk County. The Oregon Department of Aviation completed an Airport Layout Plan Report for the Independence State Airport in 1997. The Report provides for anticipated aviation facility needs over a twenty-year period. The improvements identified in the Report will allow the airport to continue to provide “safe, efficient, economical, and environmentally acceptable air transportation.” The majority of the Report’s recommendations pertain to aviation related improvements to existing airport-owned property. Report recommendations that affect non-airport-owned property include:

- An area of approximately 41 acres (540 feet wide) located along the west side of Runway 16-34 should be acquired and reserved for future general aviation parking and hangar development;
- The City of Independence and Polk County should maintain airport overlay zoning which coincides with the future approach surfaces and Federal Aviation Regulations (FAR) Part 77 surfaces. The airport overlay zoning should conform with guidelines provided by the Oregon Department of Aviation, regarding airport land use compatibility planning; and
- Safeguard the Runway Protection Zones (RPZs) by acquiring property or aviation easements for portions of the existing and future RPZs located outside airport property, not presently controlled.

### **Independence-Monmouth Comprehensive Master Bicycle Plan (December 1991)**

The Master Bicycle Plan was developed to support the goals of the Polk County Comprehensive Plan to encourage bicycles as a travel mode. The emphasis of the Master Bicycle Plan is to provide a policy and technical framework to develop a network of bikeways that link important community destinations such as neighborhoods, commercial areas, schools, and parks. This is accomplished by providing guidance in the following areas:

- Facility planning and maintenance;
- Responsibilities of participating agencies;
- Programmatic Support and Promotion of Safe Cycling; and
- Resources for Implementation

### **Ash Creek Trail Master Plan (April 2005)**

The Ash Creek Trail Master Plan supports the basic goals of the Master Bicycle Plan to provide a facility for transportation and recreational use. The proposed trail alignment aims to provide an alternative to travel on Oregon 51 and enhance and protect the Ash Creek greenway corridor. The Plan contains specific recommendations and guidelines for trail and greenway design. Also included in the plan are evaluations and resources to develop and implement the trail plan. The cities of Monmouth and Independence are in the process of constructing the first of three phases of the trail.

### **City of Independence Parks and Open Space Master Plan (1996)**

The City of Independence completed the Parks and Open Space Master Plan in 1996. This plan inventories the existing parks, analyzes the need for future parks, and develops a park system plan for the City of Independence. This information was used to identify transportation needs and develop the 1998 Independence TSP.

### **City of Independence Goals and Objectives (2005)**

The City of Independence Goals and Objectives, the product of a 2005 City Council work session, is a non-prioritized list of action items covering a range of issue categories. One issue category is Transportation Infrastructure Improvements, which includes the following Goals and Objectives:

- More [vehicular] routes east-west; and
- Update Transportation Plan & TSP projects.

### **City of Independence Strategic Plan (2002)**

In 2002, the City of Independence contracted with Rural Development Initiatives (RDI) to facilitate the development of a Strategic Plan. To complete this task, the RDI convened a series of meetings with a Strategic Plan planning group, comprised of members of the community such as citizens, elected officials, and City staff. Meetings of the group were open to the public, and public participation was allowed at all meetings. The Plan includes a Vision for the community and an Action Agenda necessary to implement that vision. Elements of the Action Agenda include:

#### **Goal 1**

A pleasant pedestrian experience and increased pedestrian safety in the City of Independence.

- Strategy #1-A: Assess and repair all sidewalks including addressing ADA issues
- Strategy #1-B: Assess and address street lighting for pedestrians
- Strategy #1-C: Assess and address where crosswalk improvements need to be made

#### **Goal 2**

Adequate City Infrastructure.

- Strategy #2-C: Improve streets and curbs

#### **Goal 5**

A safe and healthy environment for City residents.

- Strategy #5-H: Designated truck route to alleviate truck traffic

#### **Goal 7**

Independence is a livable City for its citizens.

- Strategy #7-B: Beautify and improve North Main / Oregon 51
- Strategy #7-C: Complete Ash Creek Multi-purpose Trail

## **2.2 ANALYSIS OF EXISTING LAND USES**

Independence is a growing community, with a 2005 population of 7,515, according to the 2005 Annual Oregon Population Report published by the Portland State University Population Research Center. This represents an approximately 39 percent increase from the 1997 population of 5,405 that was reported in the 1998 Independence TSP.

Based on the City's existing Comprehensive Plan, the majority of land within Independence is designated for residential use (see Figure 1). Residentially-designated land can be found throughout the city, while commercial property is generally clustered along Oregon 51, which

is the route traveling through the historic core area of the City. This historic downtown is located where Oregon 51 turns from a north/south to an east/west street in the central eastern portion of the city. Industrially designated property is found primarily along the rail line, both north and south of Oregon 51. Public service designated land includes the land in use as sewage lagoons, schools, and parks.

## 2.3 EXISTING TRANSPORTATION SYSTEM

This section describes the existing transportation facilities and services within the Independence UGB. These descriptions are based upon updates to the previous Independence TSP which were provided by City of Independence staff. Additional facilities and service information is included in Appendix A. Oregon's TSP preparation guidelines require that each modal element of the transportation system must be inventoried and assessed by function, type, capacity, and condition (OAR 660-12-020). This information is summarized on the following pages.

### Roadway Facilities

The major roadway facility in the Independence UGB is Oregon 51. Oregon 51 enters the UGB on the north side of town and runs parallel to the Willamette River for about 1.3 miles on the Independence Highway No. 193. About halfway through town, the highway turns due west and bisects Independence into northern and southern halves. The route continues as Monmouth-Independence Highway No. 43 through Monmouth, immediately west of the Independence UGB.

Other roads and streets in the Independence UGB include local, collector and secondary arterial facilities which access a variety of neighborhoods and connect the various portions of the city with each other. Streets serve a variety of travel needs ranging from those that provide predominately for through movement to those that offer direct access to adjacent property. In order to serve this wide range of uses effectively, streets are classified (and designed) by function to ensure the predominate types of travel are appropriately accommodated.

Numerous natural and man-made features, including Ash Creek, the Portland Western Railroad, and Sewage lagoons, constrain the ability to connect roadways with one another inside the City of Independence. Despite these constraints, the City of Independence has managed to achieve a street grid which provides a significant level of connectivity for vehicles, bicyclists and pedestrians.

### Functional Classification

As defined by the Federal Highway Administration, functional classification is "...the process by which streets and highways are grouped into classes, or systems, according to the character of service they are intended to provide." Independence has the following hierarchy of functionally classified streets: major arterial, minor arterial, collector, and local. This classification system is described in greater detail in the following paragraphs. Figure 2 illustrates the street functional classification system for Independence.

Independence uses four general classifications to describe its existing and future network of streets. The four functional classifications are defined as follows:

- *Major Arterial*: This is a major facility for moving large volumes of inter-area traffic primarily carrying through traffic. An arterial is intended to provide for the majority of regional travel passing through an area as well as the majority of local trips entering and leaving the urban area. It should also provide continuity for all rural arterials which

intercept the UGB and should include connections to all rural collectors. Arterials generally emphasize mobility over land access. Access to arterials should be managed to protect the mobility function of the street as much as possible.

- *Minor Arterial*: This is a two-lane facility that is designed to carry “through” traffic. Minor arterials place more emphasis on land access and offer a lower level of traffic volume and mobility than major arterials. Although a minor arterial is intended to provide more access than a major arterial, mobility is still the primary function of the street and should be preserved as much as possible.
- *Collector*: This facility connects intra-area traffic to the arterial system. Collectors provide links between an area or neighborhood and the arterial system. They supply abutting property with the same degree of land service as a local street but are usually given priority over local streets in any traffic control installations. Collectors penetrate into all areas of a City. Collectors provide a direct route to many destinations, and for longer trips, collectors connect to arterials or rural collectors.
- *Local*: This type of street primarily provides access to abutting properties and is protected from “through” traffic. Local streets entail all those not otherwise defined as arterials or collectors. While connectivity is encouraged for all streets, through traffic movement is not the intended purpose of a local street.

#### **Oregon Highway Plan Classifications**

Most of the major arterials in Independence are also Oregon State Highway facilities as adopted in the Oregon Highway Plan (OHP). Both Highway 193 and 43 (Oregon 51) have been designated as district level, non-freight routes. In addition, as illustrated in Figure 3, the following highway segment designations apply to portions of these highways:

- **Urban Business Area (UBA)**: Highway 193 (Oregon 51) from Stryker Road to Polk Street
- **Special Transportation Area (STA)**: Highway 193 (Oregon 51) from B Street to Monmouth Street and Highway 43 from Main Street to 4th Street
- **Commercial Center (CC)**: Highway 43 (Oregon 51) from 10th Street to the Independence City Limits

For further explanation of highway segment designations, UBAs, STAs, and CCs, see the Key Terms and Acronyms section on page v.

#### **Polk County Functional Classifications**

The Polk County TSP includes functional classifications for two routes, three roads, and a bridge inside the City of Independence:

##### ***Polk County Minor Arterial***

- Oregon 51 (Main and Monmouth Streets from northern UGB to western UGB) – **City of Independence Major Arterial**
- Main Street and Corvallis Road (from Oregon 51 to southern UGB) – **City of Independence Major Arterial**
- Hoffman Road and Polk Street (from Oregon 51 to western UGB) – **City of Independence Minor Arterial**
- Gun Club Road (from Hoffman Road to Oregon 51) – **City of Independence Minor Arterial**

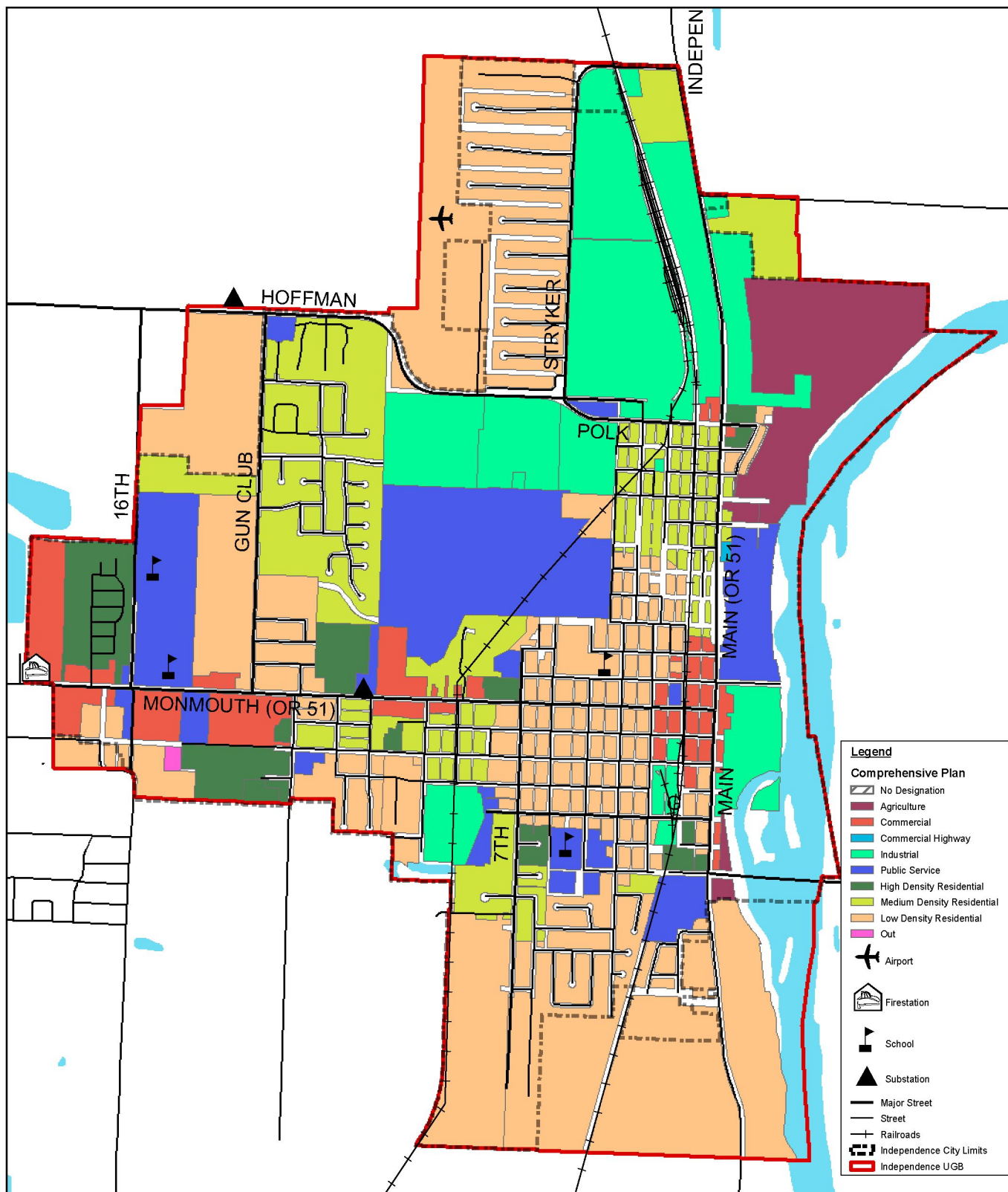

**Parametrix**

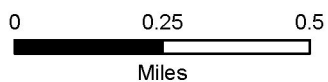

**Geographic Data Standards:**

Projected Coordinate System:  
NAD 1983 HARN StatePlane Oregon North

**Data Source(s):**

Mid-Willamette Valley Council of Governments  
Polk County GIS

Date: November 2006

*This product is for informational purposes and may not have been prepared for legal, engineering or surveying purposes. Users of this information should review or consult the primary data and information source to ascertain the usability of this information.*

**Figure 1**  
**Comprehensive Plan Land Use Designations**

INDEPENDENCE TSP

**This page intentionally left blank.**

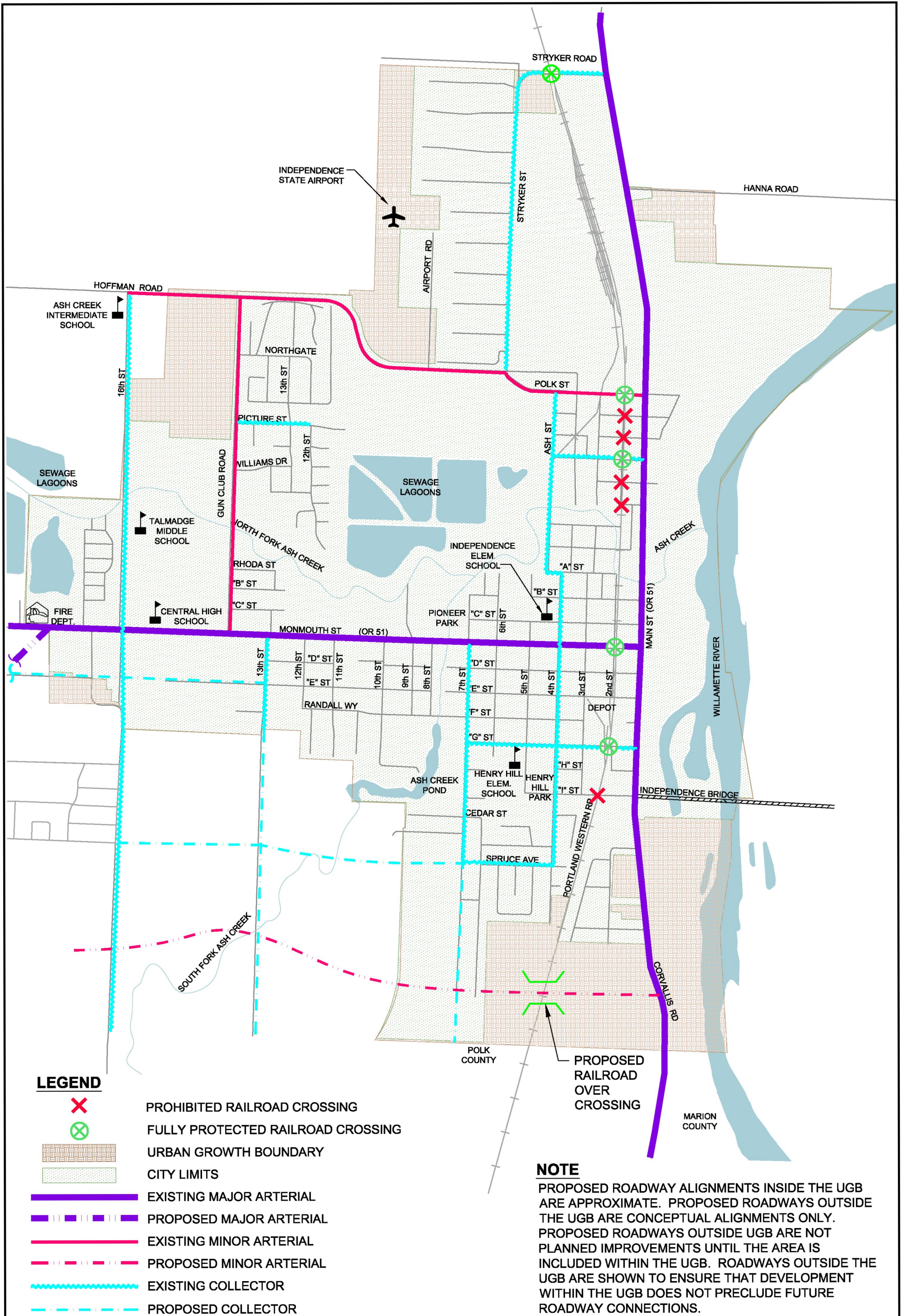

**Figure 2**  
**Independence Street System**

**This page intentionally left blank.**



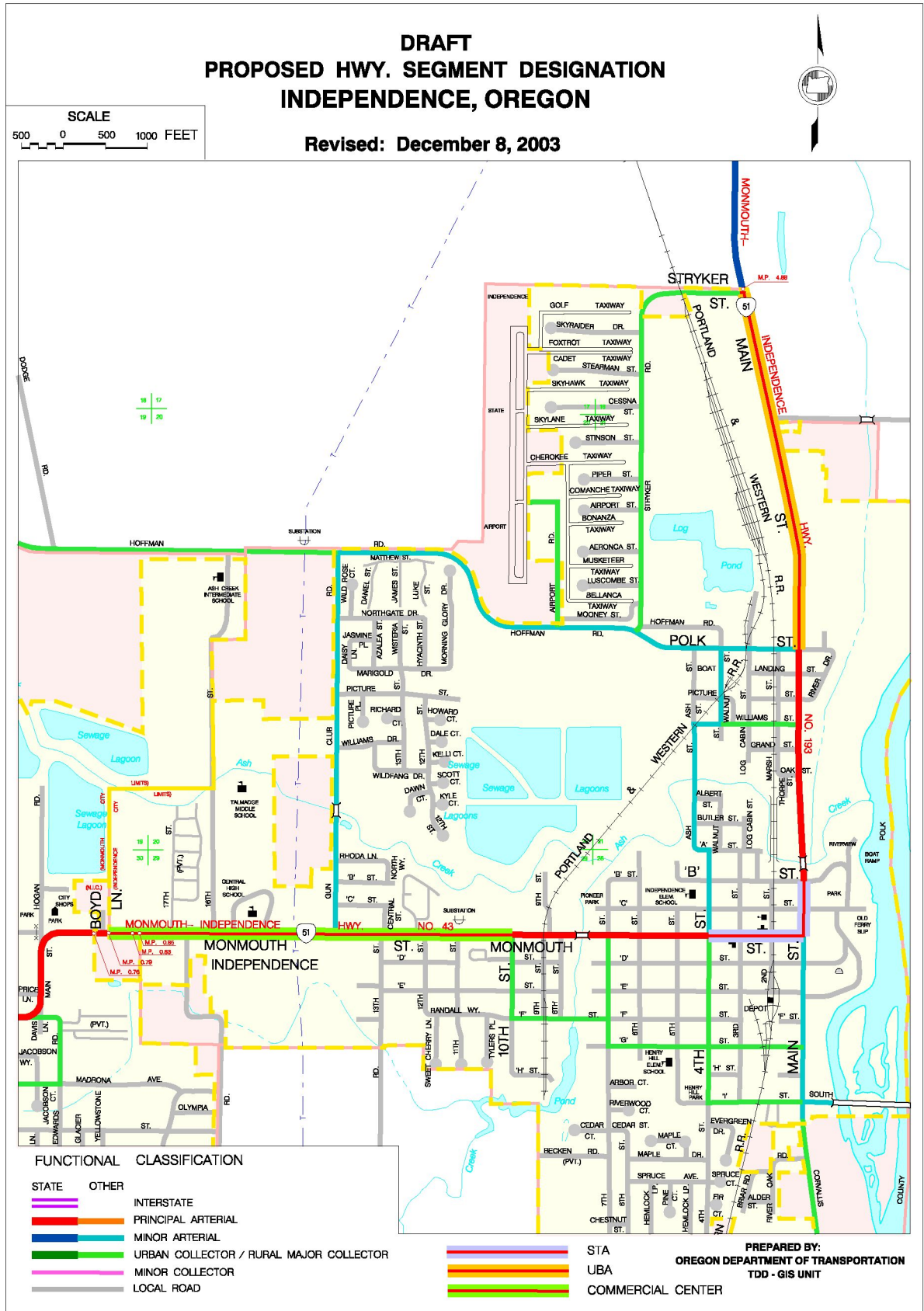

**Figure 3**  
**Oregon Highway Plan Designations**

**This page intentionally left blank.**

**Polk County Major Collector**

- The Independence Bridge (Between Corvallis Road and Marion County) – **not classified by City of Independence**

**Minor Collector**

- Talmadge Road (Between Oregon 51 and southern city limits) – **City of Independence Collector**

The Polk County and City of Independence functional classifications for roads within the City of Independence are fundamentally consistent: County designated Arterials are City designated Arterials and the County designated Collector is a City designated Collector. The two functional classification differences that exist (Oregon 51 and Main Street / Corvallis Road south of Oregon 51) are cases where Polk County designated Minor Arterials are City designated Major Arterials. These differences are the result of scale and are not inconsistencies. Polk County includes roads, such as Oregon 99W and Oregon 22, which carry significantly more traffic and link larger communities than the roads found within Independence. Because of this difference in scale, it is consistent that roads within Independence with the highest City functional classification (Major Arterials) do not receive the highest County functional classification (Principal Arterial).

**Street Standards**

Consistent with the identification of streets by functional classification is the need to develop and utilize street standards that guide the physical design of facilities falling into the four functional classifications. The adoption of street standards provides a city with the means of insuring consistency, safety and aesthetic quality in roadway design. In addition, design standards provide appropriate guidance when roadways are planned and constructed. While it is important to have recognized standards for street design, major street projects often need to be evaluated on an individual basis. Strict adherence to street standards, including such factors as distance between intersections, access points and relationship to adjacent land uses, may not be practical in all situations given existing development patterns or other social, economic or environmental constraints.

Current adopted street standards are summarized in Table 2-2 and text below.

**Table 2-2. Independence Street Design Standards**

Feature	Major Arterial Streets	Minor Arterial Streets	Collector Streets	Local Streets >20 DUs	Local Streets < 20 DUs
Right-of-way width	84 feet <sup>(a)</sup>	66 feet <sup>(a)</sup>	66 feet <sup>(a)</sup>	60 feet	50 feet
Curb-to-curb width	60 feet	36 feet	36 feet	36 feet	28 feet
Moving Lanes	2-4	2	2	2	2
Turn Lanes	<sup>(b)</sup>	<sup>(b)</sup>	<sup>(b)</sup>	0	0
Bike Lanes	2 @ 6'	2 @ 6'	Ph 1: Shared Ph 2: 2 @ 6' <sup>(c)</sup>	Shared	Shared
Parking Lanes	No <sup>(d)</sup>	No	Ph 1: 2 sides Ph 2: No <sup>(c)</sup>	2 sides	1 side
Sidewalks	2 @ 6'	2 @ 6'	2 @ 5'	2 @ 5'	2 @ 5'

Source: City of Independence, 2006

a. Additional right-of-way and roadway improvements may be required at major intersections to provide for turn lanes.

b. At all intersections where separate lanes are needed due to volume of turning movement activity.

c. Collectors with < 2,000 ADT can accommodate on-street parking and shared use of road space by bicyclists and motor vehicles. For collectors with > 2,000 ADT the city will study the need to eliminate on-street parking and provide bike lanes.

d. Parking is currently allowed along some sections of the arterial streets in the downtown business district. Existing on-street parking will be allowed to continue until such time as traffic volumes on roadways increase to a level where significant conflicts between moving traffic and parking occur. Parking needs will be evaluated as a part of roadway projects to improve capacity and meet new design standards.

### **Access Management**

The term access management refers to the process of balancing the need for access to parcels of land adjacent to roadways with the need for safe and efficient through movement of vehicular traffic on the roadway. Access management can be implemented by a variety of means. These include median controls (e.g., raised concrete medians); driveway spacing and/or driveway consolidation (so that there are fewer driveways serving one parcel or multiple parcels); requiring that driveways be placed on lower order streets where a parcel abuts both higher and lower order streets; intersection spacing to reduce the number of conflict points; and signalization restrictions along a street, as the frequency of intersections and signals can reduce the benefits of effective signal timing progression.

Access management is closely related to street functional classification. Typically, when access controls are in place, the frequency of driveways and intersecting streets is more restrictive along state highways and major arterials where the movement of traffic takes a higher priority. Access controls are less restrictive along collector streets where there is greater balance between access and mobility. Access controls are restricted only by safety considerations along local streets, as property access is the primary function of these streets.

Frequent driveway and cross-street access can significantly degrade traffic operations along major streets as motorists must contend with people slowing to turn into adjacent property or attempting to get back onto the major street from a side access location. Not only do frequent driveways adversely affect the operational capacity of a road, they also affect safety in that each driveway or intersecting street represents a potential conflict point for through-moving vehicles. The strip development that often occurs as a result of the lack of access control can also be inhospitable to pedestrians and can be difficult to adequately serve by transit due to the spread out nature of destinations.

Access management can be most effectively implemented during the land development process when access locations and localized street improvements can be adapted to ensure that adjacent street traffic-carrying functions are not degraded. Access management controls are more difficult to implement along streets with developed property due to possible right-of-way limitations and/or the concerns of property owners about business or on-site circulation impacts. In these cases, access controls can be incorporated into a roadway improvement project.

#### ***Access Management along State Highways***

In Independence, most major arterial streets are also state highways (e.g., Oregon 51). The exception is Main Street between Monmouth Street and the southern edge of the UGB. ODOT has sole responsibility for approval and permitting of access to state highways and Independence must coordinate this design element with ODOT for all access points along Oregon 51.

New access to/from a state highway is provided consistent with the standards adopted in the Oregon Highway Plan and the Access Management Administrative Rule (OAR 734-051-0115) for each highway classification, its location within an urban or rural area, and its posted speed (see Table 2-3 and Appendix A). Oregon 51 has been designated as a District highway and the following access management standards would apply within Independence.

**Table 2-3. Access Management Spacing Standards for Private and Public Approaches on District Highways<sup>(1)(2)(3)(4)</sup> (Measured in Feet)\***

Posted Speed <sup>(5)</sup>	Urban**	STA
55	700	
50	550	
40 & 45	500	
30 & 35	350	(6)
≤25	350	(6)

\* Measurement of the approach road spacing is from center to center on the same side of the roadway.

\*\*These standards also apply to Commercial Centers.

Notes on Tables 2-3:

- (1) These access management spacing standards are for unsignalized approaches only. Signal spacing standards supersede access management spacing standards for approaches.
- (2) These access management spacing standards do not apply to approaches in existence prior to April 1, 2000, except as provided in OAR 734-051-0115(1)(c) and 734-051-0125(1)(c).
- (3) For infill and redevelopment, see OAR 734-051-0135(4).
- (4) For deviations to the designated access management spacing standards see OAR 734-051-0135.
- (5) Posted (or Desirable) Speed: Posted speed can only be adjusted (up or down) after a speed study is conducted and that study determines the correct posted speed to be different than the current posted speed. In cases where actual speeds are suspected to be much higher than posted speeds, the Department reserves the right to adjust the access management spacing accordingly. A determination can be made to go to longer access management spacing standards as appropriate for a higher speed. A speed study will need to be conducted to determine the correct speed.
- (6) Minimum access management spacing for public road approaches is the existing city block spacing or the city block spacing as identified in the local comprehensive plan. Public road connections are preferred over private driveways and in STAs driveways are discouraged. However, where driveways are allowed and where land use patterns permit, the minimum access management spacing for driveways is 175 feet (55 meters) or mid-block if the current city block spacing is less than 350 feet (110 meters).

In developed areas the city will work with ODOT and property owners to minimize the number of access points and to provide optimum access spacing as the opportunity arises. The city and ODOT may develop access management guidelines that enable the city and ODOT to achieve certain operational and safety objectives for specific roadway segments.

#### **Access Management along City Streets**

The City of Independence has established access management standards in its Development Code and these standards for minor arterial and collector roadways are summarized in Table 2-4 below. As indicated previously, much of the major arterial street system in the city is Oregon 51 and the city's access management standards for Oregon 51 are consistent with ODOT requirements.

**Table 2-4. Access Management Standards for City Streets**

Functional Class	Minimum Speed Posted	Minimum Spacing Between Driveways	Spacing Between Intersections
Major Arterial	35-50	250 feet	¼ mile
Minor Arterial	35-50	250 feet	250 feet
Major Collector	25-40	100-150 feet	250 feet
Collector	25-40	100-150 feet	250 feet

Source: City of Independence Development Code, 2007.

In addition to the information contained in Table 2-4, the City's access management standards included in the 1998 TSP encourage the following:

- **For major and minor arterials** – When pre-existing patterns of land ownership preclude the application of spacing standards, the city will encourage property owners to share private drives or to obtain access via the local and/or collector street system wherever feasible.
- **For collector streets** – Access to collectors is permitted by both streets and private drives. However, the city will encourage property owners to minimize access to collector streets according to the following guidelines: on-site vehicle turn-arounds, adequate off-street parking, safe intersection sight distance, and safe off-set distance between intersections on opposing sides of the street. The city will encourage combined access to collector streets wherever practical.
- **For local streets** – A well-connected local street network is important for convenient bicycle and pedestrian access. Cul-de-sac streets will continue to be discouraged in favor of establishing connections with existing or planned streets. Because local streets serve a wide range of uses, including neighborhood play areas, the city will explore options to discourage “through” traffic and speeds in excess of 25 mph. Local streets that include design features such as curves and “T” intersection may be a useful means of reducing conflicts and discouraging through traffic.

#### **Analysis of Traffic Operations**

The analysis of existing traffic conditions within the City of Independence focuses on eight key intersections located throughout the City, and a County intersection located outside the City UGB (Hoffman Road at 16th Street). These intersections are:

- Hoffman Road at 16th Street (unsignalized);
- Hoffman Road at Gun Club Road (unsignalized);
- Monmouth Street (Oregon 51) at 16th Street (signalized);
- Monmouth Street (Oregon 51) at Gun Club Road (signalized);
- Monmouth Street (Oregon 51) at 7th Street (unsignalized);
- Main Street (Oregon 51) at Polk Street (unsignalized);
- Main Street (Oregon 51) at Stryker Road (unsignalized);
- Main Street at ‘G’ Street (unsignalized); and
- Main Street (Oregon 51) at Monmouth Street (Oregon 51) (3-way stop controlled).

Each of the unsignalized intersections is stop-controlled on the minor street approach. Two of the intersections operate with traffic signals, one as a three way stop. Existing lane configurations and traffic control for the nine study area intersections are shown in Figure 4.

#### **Intersection Operating Standards**

Within the state of Oregon, traffic operations are evaluated based on two sets of criteria or standards. The operative standard used by ODOT for state highways is the volume-to-capacity (V/C) ratio, and is expressed in terms of a ratio between traffic volumes and the roadway or intersection's capacity. Many local communities assess the quality of traffic performance in terms of intersection or roadway levels of service (LOS). These two operational standards are described below.

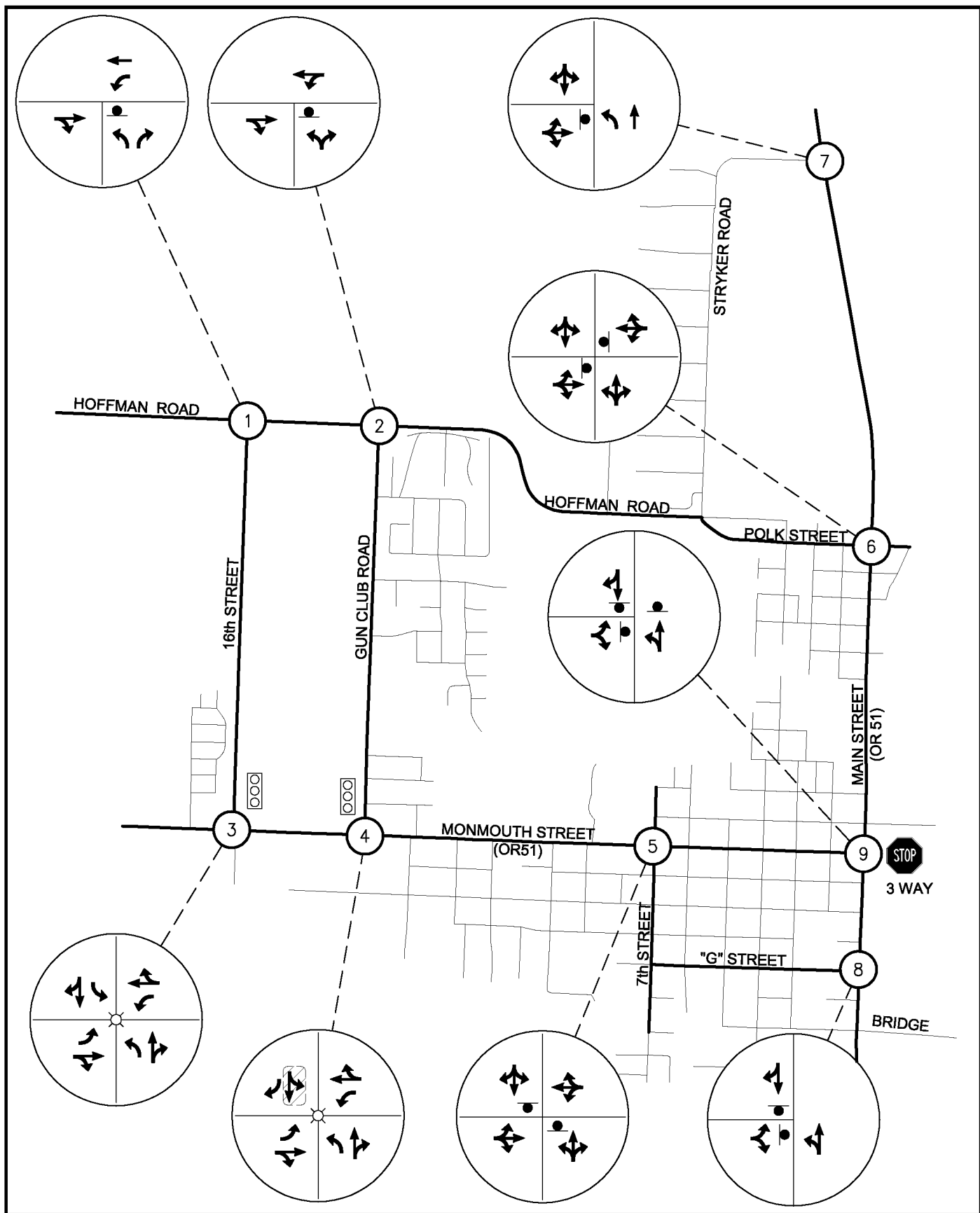

Parametrix DATE: May 01, 2007 FILE: PO2396051P05F-11

**LEGEND**

- SIGNALIZED INTERSECTION
- STOP CONTROLLED
- EXISTING TRAFFIC MOVEMENT
- MOVEMENT ADDED AFTER TRAFFIC ANALYSIS

**Figure 4**  
Existing Intersection Geometry  
INDEPENDENCE, OREGON

**This page intentionally left blank.**



**Volume to Capacity Ratios**

As adopted in the 1999 Oregon Highway Plan (OHP), ODOT uses V/C ratios to measure state highway performance rather than intersection or roadway LOS. A V/C ratio expresses the relationship between traffic volumes and a roadway or intersection’s theoretical capacity. Various V/C thresholds are applied to all state highways based on functional classification of these facilities.

Table 2-5 provides a short summary of volume-to-capacity ranges as presented in the Highway Capacity Manual published by Transportation Research Board, Washington DC, 2000. The V/C ratio (and average delay) is calculated differently for signalized and unsignalized intersections. At signalized intersections, V/C ratios are calculated separately for each lane group, as well as for the intersection as a whole.<sup>1</sup>

In contrast, at unsignalized intersections both delay and V/C ratios are calculated for each traffic movement affected by right-of-way controls like stop signs. A V/C ratio above 1.0 often accompanies level of service LOS E or LOS F conditions, indicating that there is inadequate capacity for one or more movements. At intersections operating at LOS D or better, v/c ratios above 1.0 are indicators of such issues as sub-optimal signal timing or inadequate turn lane storage. For unsignalized intersections, low levels of service (e.g., LOS E or F) and/or high v/c ratios typically indicate that there is a side street movement that faces substantial conflicting traffic or inadequate gaps on the major street where traffic does not have to stop. The v/c standard can, at times, indicate potential intersection operational problems even when the delay (and LOS) is acceptable.

**Table 2-5. Volume to Capacity Ratio Description**

Volume to Capacity Ratio	Description of Condition
0.00-0.60	<b>Free Flow/Insignificant Delays:</b> No approach phase is fully utilized by traffic and no vehicle waits longer than one red indication. Most vehicles do not stop at all. Progression is extremely favorable and most vehicles arrive during the green phase.
0.61-0.70	<b>Stable Operation/Minimal Delays:</b> An occasional approach phase is fully utilized. Many drivers begin to feel somewhat restricted within platoons of vehicles. This level generally occurs with good progression, short cycle lengths, or both.
0.71-0.80	<b>Stable Operation/Acceptable Delays:</b> Major approach phases fully utilized. Most drivers feel somewhat restricted. Higher delays may result from fair progression, longer cycle lengths, or both. Individual cycle failures may begin to appear at this level, and the number of vehicles stopping is significant.
0.81-0.90	<b>Approaching Unstable/Tolerable Delays:</b> The influence of congestion becomes more noticeable. Drivers may have to wait through more than one red signal indication. Longer delays may result from some combination of unfavorable progression, long cycle lengths, or high v/c ratios. The proportion of vehicles not stopping declines, and individual cycle failures are noticeable.

<sup>1</sup> A lane group is a combination of one or more left, through and/or right turn lanes that move together at an intersection.

**Table 2-5. Volume to Capacity Ratio Description**

Volume to Capacity Ratio	Description of Condition
0.91-1.0	<b>Unstable Operation/Significant Delays:</b> Volumes at or near capacity. Vehicles may wait through several signal cycles. Long queues form upstream from intersection. These high delay values generally indicate poor progression, long cycle lengths, and high v/c ratios. Individual cycle failures are a frequent occurrence.
>1.00	<b>Forced Flow/Excessive Delays:</b> Represents jammed conditions. Queues may block upstream intersections. This level occurs when arrival flow rates exceed intersection capacity, and is considered to be unacceptable to most drivers. Poor progression, long cycle lengths, and v/c ratios approaching 1.0 may contribute to these high delay levels.

Source: Highway Capacity Manual, Transportation Research Board, 2000.

Oregon 51 is a district level, non-freight route inside a non-MPO municipal UGB. In addition, the following highway segment designations apply to portions of Oregon 51 inside Independence:

- Urban Business Area (UBA): Oregon 51 (Main Street) from Stryker Road to Polk Street
- Special Transportation Area (STA): Oregon 51 (Main Street) from B Street to Monmouth Street and Oregon 51 (Monmouth Street) from Main Street to 4th Street
- Commercial Center (CC): Oregon 51 (Monmouth Street) from 10th Street to the Independence City Limits

The peak hour, maximum V/C standards for various portions of Oregon 51 are summarized in Table 2-6.

**Table 2-6. Oregon 51 (Hwys 193 & 43) Peak Hour, Maximum V/C Standards**

District Highway, Inside UGB, Non-MPO Designations	Maximum V/C Ratio
STA	0.95
Posted speed ≤35 mph or UBA	0.90
Posted speed >35 mph	0.85
Posted speed ≥45 mph	0.80

Source: Oregon Highway Plan, Policy 1F Mobility Standards, Table 6.

### **Intersection Levels of Service**

Another measure of intersection operating performance during peak travel periods is based on average control delay per vehicle entering the intersection. This delay is calculated using equations that take into account turning movement volumes, intersection lane geometry and traffic signal features, as well as characteristics of the traffic stream passing through the intersection, including time required to slow, stop, wait, and accelerate to move through the intersection. Various levels of delay are then expressed in terms of levels of service for either signalized or unsignalized intersections. The various LOS range from LOS A (free-flow conditions) through LOS F (operational breakdown). Between LOS A and LOS F, progressively higher LOS grades reflect increasingly worse intersection performance, with

higher levels of control delay and increased congestion and traffic queues. Characteristics of each LOS are briefly described below in Table 2-7.

**Table 2-7. Level of Service Definitions**

Level of Service	Average Delay/Vehicle (sec.)		Description
	Signalized	Unsignalized	
A (Desirable)	<10 seconds	<10 seconds	Very low delay; most vehicles do not stop.
B (Desirable)	>10 and <20 seconds	>10 and <15 seconds	Low delay resulting from good progression, short cycle lengths, or both.
C (Desirable)	>20 and <35 seconds	>15 and <25 seconds	Higher delays with fair progression, longer cycle lengths, or both.
D (Acceptable)	>35 and <55 seconds	>25 and <35 seconds	Noticeable congestion with many vehicles stopping. Individual cycle failures occur.
E (Unsatisfactory)	>55 and <80 seconds	>35 and <50 seconds	High delay with poor progression, long cycle lengths, high V/C ratios, and frequent cycle failures.
F (Unsatisfactory)	>80 seconds	>50 seconds	Very long delays, considered unacceptable by most drivers. Often results from over-saturated conditions or poor signal timing.

Source: 2000 Highway Capacity Manual, Transportation Research Board.

### **Existing Traffic Operations**

The City of Independence and ODOT staff selected nine study intersections shown in Figure 5 for analysis. These intersections were chosen to update existing conditions as reflected in the 1998 Independence Transportation System Plan, to incorporate the new study areas, and to address areas of noted concern. Traffic counts, Level of Service calculation sheets, descriptions of Level of Service for signalized / unsignalized intersections and analysis methodology can be found in the Appendix B of this report.

ODOT provided turning movement counts for seven of the study intersections, the two remaining were supplied by the City of Independence. A review of traffic count data indicated that City streets traffic activity peaked from 5 pm to 6 pm. Independence traffic is characterized as commuter, with some seasonal changes in traffic and commuting patterns. Accordingly, adjustments to count data taken outside of the peak season were required to ensure that they reflect appropriate conditions for use in assessing conceptual design for improvement options. The count data, turning movement volumes, intersection analysis worksheets and traffic analysis methodology are included in Appendix B. Currently the intersections generally experience minimal delays.

Table 2-8 summarizes the results of intersection operations analysis for existing conditions. As noted in the table, the northbound approach at the intersection of Monmouth Street with 7th Street experiences the greatest delay.

**Table 2-8. 2006 (30 HV) Operations at Key Intersections in Independence**

Signalized Intersections		V/C Ratio	Average Delay (sec/vehicle)	LOS
Monmouth St. (OR 51) @ 16th Street		0.56	36.7	D
Monmouth St. (OR 51) @ Gun Club Road		0.70	31.1	C
Unsignalized Intersections	Critical Movement	Critical V/C Ratio	Critical Delay (seconds/vehicle)	Critical LOS
Hoffman Road @ Gun Club Road	Northbound	0.33	15.6	C
Hoffman Road @ 16th Street	Northbound	0.10	14.3	B
Monmouth St. (OR 51) @ 7th Street	Northbound	0.52	48.0	E
	Southbound	0.07	17.1	C
Main St. (OR 51) @ Polk Street	Eastbound	0.38	18.9	C
	Westbound	0.05	17.0	C
Main St. (OR 51) @ Stryker Road	Northbound	0.01	8.4	A
	Eastbound	0.28	18.2	C
Main St. (OR 51) @ Monmouth St. (OR 51)	All-Way Stop		17.1	C
Main St. @ 'G' Street	Eastbound	0.35	20.6	C

Note 1: LOS means intersection level of service.

Note 2: "Critical Delay" and "Critical LOS" refers to the delay or LOS experienced for the specific intersection traffic movement listed.

### **Summary of Existing Roadway System Needs and Deficiencies**

The following paragraphs provide a brief summary of existing roadway system needs and deficiencies in the Independence UGB which provides the basis for short-term improvement recommendations.

### **Summary of Traffic Operational Needs**

There are no significant roadway traffic operational problems within the Independence UGB. However, some noticeable delay is presently being experienced during peak periods for stop-controlled northbound traffic at the intersection of Monmouth Street (Oregon 51) with 7th Street. In addition, efficiency issues are caused by the existence of east/west stop signs on G Street. G Street is a designated collector street, providing an alternative route for local traffic seeking to avoid portions of Monmouth Street (Oregon 51). Replacing G Street's east/west stop signs with north/south stop signs would increase the usefulness of this road as a local traffic alternative route.

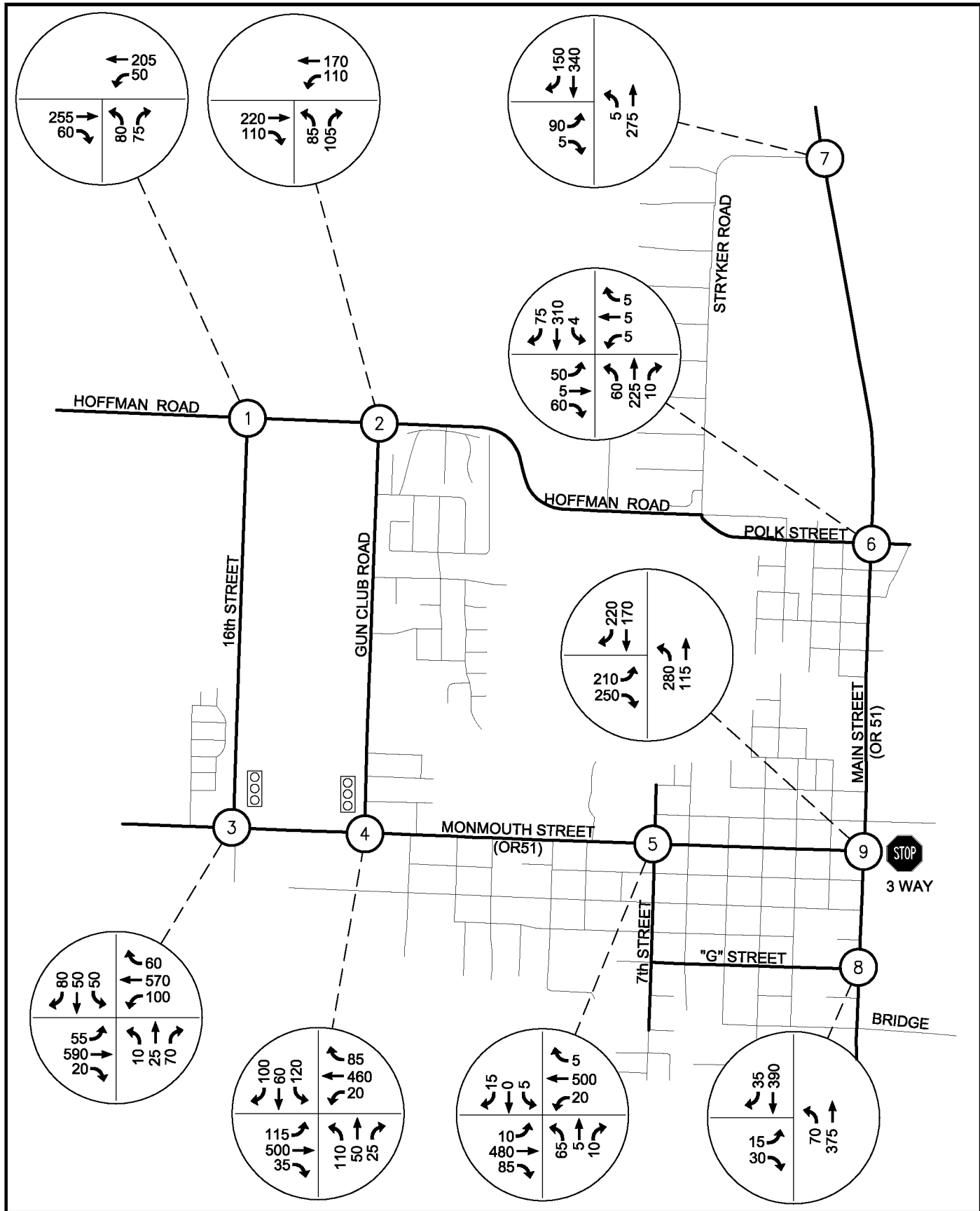

Parametrix DATE: Apr 04, 2007 FILE: PO2396051P05F-02



**LEGEND**

↪ 105 TURNING MOVEMENT BY DIRECTION OF TRAFFIC

**Figure 5**  
**2006 Balanced Traffic Volumes**

INDEPENDENCE, OREGON

**This page intentionally left blank.**

### **Summary of Roadway Safety Issues**

The analysis of existing transportation system conditions included as assessment of existing safety problems within the Independence UGB. In summary, as of 2006 there were no locations along Oregon 51 in the UGB in the top 10 percent of ODOT's Safety Priority Index System (SPIS). This indicates that there are no significant, high priority roadway improvement needs based on crash experience. Additionally, no major traffic safety issues were reported on the City road network. There are three primary roadway safety issues in the City of Independence:

- **Railroad crossings.** The Willamette & Pacific (W&P) Railroad operates rail transportation services inside the Independence city limits. Safety issues related to railroad operations include four at-grade, unprotected crossings, and pedestrian tripping and bicycling hazards resulting from deteriorated asphalt along the rail line on 2<sup>nd</sup> Street, between "B" and "E" Streets.
- **Sidewalk and bicycle lane deficiencies.** As noted in the following Bicycle and Pedestrian Facilities section, gaps in sidewalks and bicycle lanes exist in various areas within the city, including along the west side of Gun Club Road, a minor arterial within a well populated residential area. These gaps pose a hazard to pedestrians and bicyclists, as well as potential conflicts with auto traffic. Sidewalk deficiencies also include obstructions, such as power poles, blocking portions of some sidewalks and intersections with missing curb cuts, issues which force some wheelchair users into the roadway.
- **Safety conflicts near Central High School.** Highway safety and congestion problems are caused by significant numbers of Central High School students crossing Monmouth Street during the lunch break, including some students who fail to use approved crossings and/or obey traffic signals.

### **Bicycle and Pedestrian Facilities**

This section provides a brief summary of the existing bicycle and pedestrian circulation systems and a general assessment of improvement needs.

Bicycle facilities can generally be categorized as bicycle lanes; shared facilities, including widened shoulders; and bicycle paths (also known as multi-use paths). Bicycle lanes are defined as that portion of a street that is designated by striping and pavement markings for the preferential or exclusive use of bicyclists. Shared facilities include locations where the bicyclist and the motorist must share a travel lane, as well as roadway shoulders contiguous to a travel lane where space is shared by bicyclists, pedestrians, emergency use by vehicles and for lateral support of the roadway pavement section. Bicycle paths are physically separated from the vehicle travel lane by an open space or barrier. A bicycle path may be located within the roadway right-of-way or on a separate right-of-way. Bicycle paths are also known as multi-use paths as they can be used by bicyclists, as well as pedestrians, joggers, skaters, and other non-motorized travelers.

The inventory of bicycle and pedestrian facilities in Independence is based on a visual assessment completed by City of Independence staff in the spring of 2007. Bikeway facilities in Independence include bike lanes, shared facilities and 500 feet of a multi-use path (see discussion of Ash Creek Trail, below). Although bicycle facilities are located on the majority of Major and Minor Arterial streets in the Independence UGB (see Figure 6), some portions of these streets presently lack bicycle amenities. Major and Minor Arterials with bike lanes include Monmouth Street (Oregon 51) from the South Fork of Ash Creek Bridge (located between 7th and 8th Street) to the western city limits, and along the entire east side of Gun Club Road. Main Street (Oregon 51) was reconstructed in 2007, and bike lanes now exist on

the east and west sides of Main Street, from Polk Street to Hanna Road, and on the west side of Main Street from Hanna Road to Stryker Road, which is the urban growth boundary. Bike lanes also exist on the east and west sides of the Hoffman Road / Polk Street Corridor, between Ash Street and 16th Street. Currently, the only other roadway with bike lanes in Independence is 16th Street, which has a Collector street designation. 16th Street has bike lanes on its east and west side from Monmouth Street (Oregon 51) to Hoffman Road, and a bike lane on its west side from Monmouth Street to Talmadge Road. The remaining Collector streets, and the Local Service streets, in Independence are shared facilities.

The City of Independence sidewalk system varies from neighborhood to neighborhood (see Figure 7). Sidewalks exist in some of the downtown area and adjacent older neighborhoods, particularly to the north and south of the core area. Additionally, sidewalks are provided in many of the newer subdivisions in the northwestern portion of the city, and along Monmouth Street and the majority of Main Street (Oregon 51). These sidewalks provide connections linking many of the residential areas to such pedestrian attractors as schools, commercial areas and employment opportunities. However, many of the older neighborhoods south of Monmouth Street and in the northeastern portion of the City either do not have sidewalks or have only a limited and disconnected sidewalk system. On the City's two minor arterials (Gun Club Road and Hoffman Road), sidewalks are limited to one side of the street or not available at all. Sidewalks, meeting ADA standards, are now required as part of all land development projects in Independence, so these facilities will become a part of the future transportation system. Sidewalk deficiencies also include obstructions, such as power poles, blocking portions of some sidewalks and intersections with missing curb cuts. Impacts of sidewalk deficiencies include forcing pedestrians, especially wheelchair users, into the roadway along some travel route. Future development will not in and of itself lead to the removal of obstacles and the addition of future curb cuts.

One significant bicycle and pedestrian amenity that has been proposed for the City is the Ash Creek Trail. Once complete, the trail will be developed as a multi-use facility for bicycles and pedestrians only and will run along the Ash Creek Greenway corridor north of, and generally parallel to, Oregon 51. The proposed trail alignment aims to provide a transportation alternative to Oregon 51 and Hoffman Road, with connections to other Independence and Monmouth roadways. This trail is more fully defined in the Ash Creek Trail Master Plan. Though the cities of Monmouth and Independence are in the process of constructing the first of three phases of the trail, thus far only 500 feet of trail have been built in Independence, from 16th Street to the east, just north of Talmadge Middle School.

Figure 6 shows those areas of the City which have bicycle lanes and Figure 7 shows those areas that lack sidewalks. The proposed Ash Creek Trail is also shown in both figures. As noted above, most streets in Independence have sidewalks in fair condition while bike lanes exist only along some arterial roadways.

The construction of additional bicycle and pedestrian facilities in Independence is required as streets are improved, if such facilities are unconstrained by physical conditions or existing buildings. Additions of bicycle lanes to higher speed Major and Minor Arterials (>25mph) and high volume Collector streets (>2,000 ADT) are top priority. Additions of sidewalks to arterial and collector streets are a top priority, particularly those near existing schools.



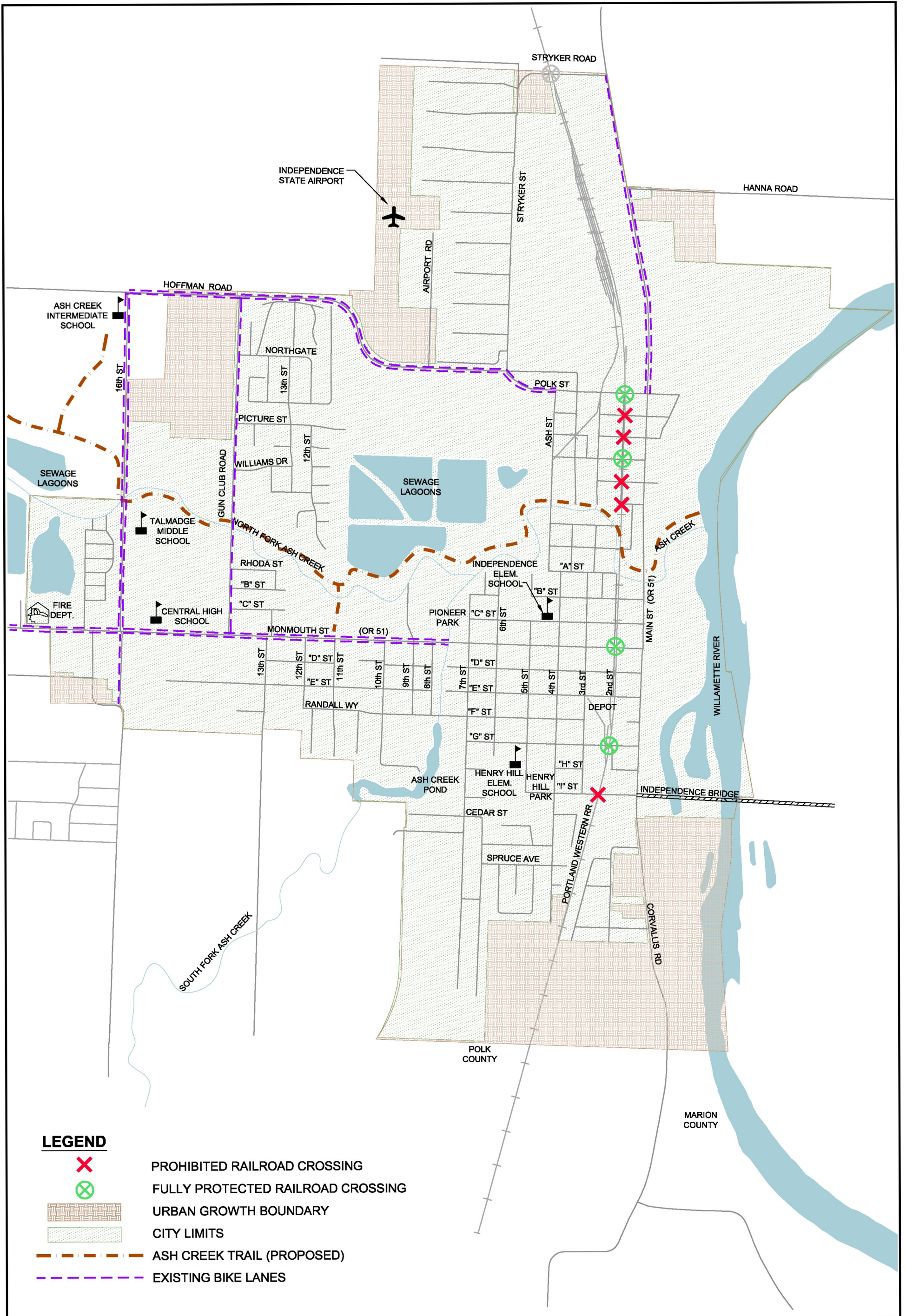

**LEGEND**



PROHIBITED RAILROAD CROSSING



FULLY PROTECTED RAILROAD CROSSING



URBAN GROWTH BOUNDARY



CITY LIMITS

--- ASH CREEK TRAIL (PROPOSED)

--- EXISTING BIKE LANES



**Figure 6  
Bicycle Facilities**

**This page intentionally left blank.**

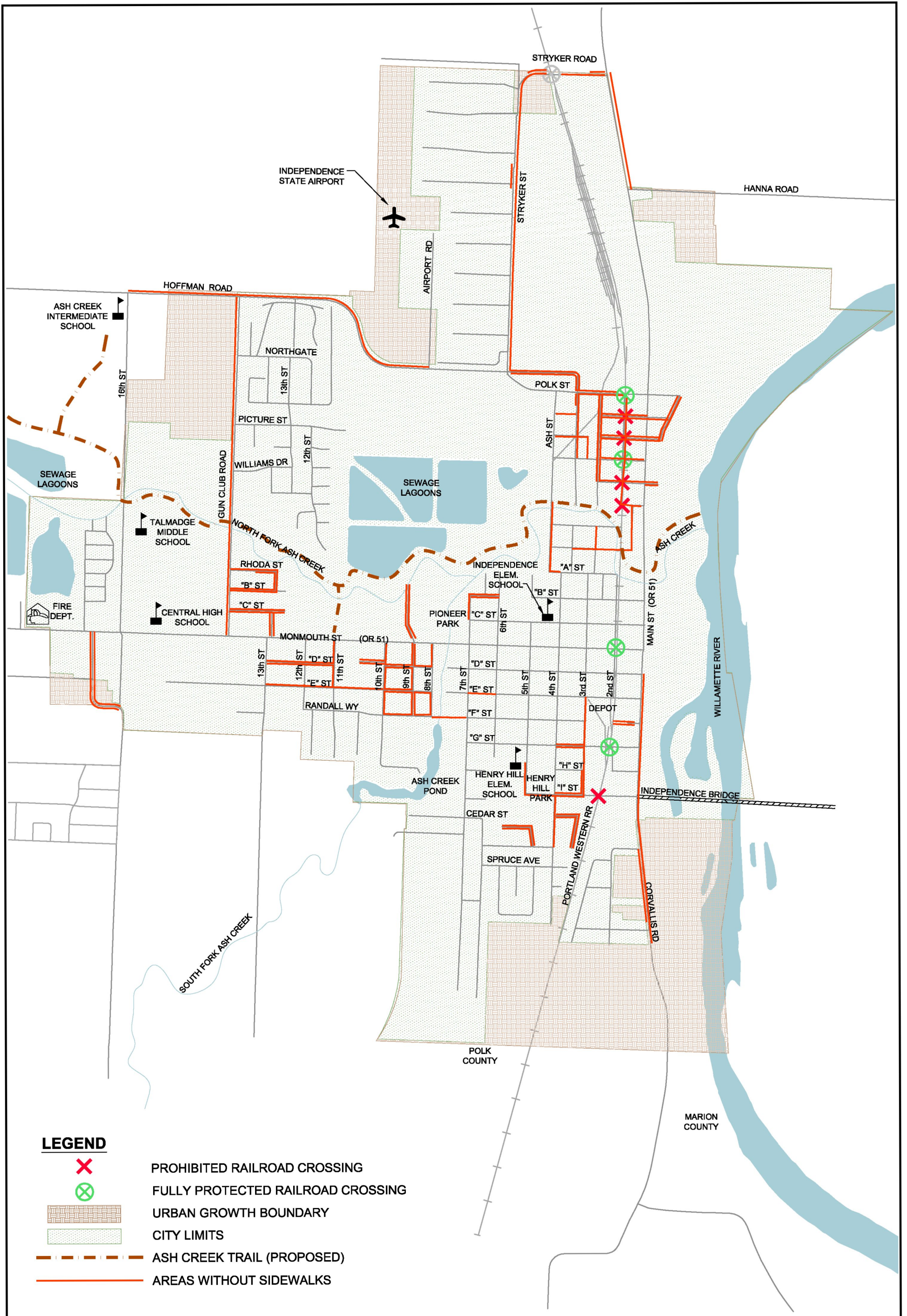

**Figure 7  
Pedestrian Facilities**



**This page intentionally left blank.**

## Public Transit

### Existing Services

This section describes existing public transit services available in the Independence UGB, including local and intercity public transit service and paratransit services for the elderly and/or people with disabilities.

Within the community, public transit services fulfill dual roles. On one hand, these services provide transportation for those who cannot or choose not to drive their own automobile. On the other hand, the provision of good local transit service is a key measure of quality of life within a community in that, along with walking and bicycling, it provides an alternative to driving. The 1998 Independence TSP identifies goals to encourage the use of alternative travel modes to conserve energy and enhance air quality. Transit can be an important element in the toolbox of strategies to encourage higher density, mixed use development and a more compact form of urban development where driving to meet basic travel needs becomes optional.

Those living within the Independence UGB can access three public transit services through the Oregon Housing and Associated Services, Inc. (OHAS). Polk and Marion Counties are served by the OHAS deviated, fixed-route transit system known as the Chemeketa Area Regional Transportation System (CARTS). While service is available to all members of the public, CARTS service is primarily focused on meeting the inter-regional connectivity needs of senior citizens, disabled and economically disadvantaged residents. CARTS service presently connects the City of Independence with Salem, Monmouth and Dallas. Though CARTS' fixed-route is on Oregon 51 in Independence, CARTS will deviate up to 3/4 mile from their route to provide curb-to-curb service to seniors and those with disabilities.

OHAS surveyed riders on the CARTS system in 2007, but has yet to publish the results. The survey showed that while existing users largely represent low-income populations, CARTS riders come from a variety of age groups and use this service to reach a variety of destination types. The results of this survey, as shown in table 2-9 below, also indicates the mobility importance of the CARTS service. When surveyed while riding on the CARTS system, 51 percent of those surveyed indicated they would not have made the trip they were on if CARTS were not available.

**Table 2-9. 2007 Survey of CARTS Ridership Characteristics**

User Characteristic	Percent	User Characteristic	Percent
<i>Income Level</i>		<i>Mode to/from Bus Stop</i>	
Under 15,000	59%	Walk	57%
15,000-35,000	26%	Transfer from other service	23%
36,000-50,000	8%	Bike	5%
Other/No Response	7%	Other/No Response	15%
<i>Age</i>		<i>Trip Purpose</i>	
19-30	26%	Work	36%
31-59	44%	Shopping	13%
60+	18%	Recreation	12%
Other/No Response	12%	Medical	9%
		Personal	8%
		School	7%
		Other/No Response	15%

Source: Unpublished survey of CART ridership, Mary Renneke, Oregon Housing and Associated Services, Inc., 2007.

In addition to CARTS, OHAS provides a Dial-A-Ride service for seniors and people with disabilities who require door-to-door assistance or who live outside the 3/4 mile CART deviated service boundaries. OHAS also manages the Triplink Brokerage, a call center coordinating transit services operated by private providers. The Triplink Brokerage operators provide curb-to-curb service to Medicaid clients traveling to medical trips in Polk, Marion and Yamhill Counties.

There are currently no privately operated bus or rail passenger services in Independence. There are no taxi companies located in Independence, though there is taxi service available to and from Salem. Based on a phone survey of the two Salem taxi companies listed on the internet, taxi service between downtown Independence and downtown Salem costs between \$25 and \$30, one-way.

### **Needs**

Written in 1998, the Polk County TSP concluded that the need for paratransit services for Polk County residents, including Independence residents, would grow as “baby boomers” aged. This has shown to be true, as in 2006, 14.3 percent (or 9,501), of Polk Counties residents were 65 years of age or over, resulting in an increased need for public transit service that provides for basic mobility and commuter service needs.

The Oregon Public Transportation Plan (ODOT, 1997) establishes a transit service vision and specific goals relevant to the City of Independence and Polk County. The plan identifies minimum levels of public transit which provide a range of services intended to keep pace with Oregon’s changing and increasing transit needs. Minimum level of service recommendations are identified by types of service, size of community, and distance from other major intermodal transportation centers (e.g. Portland). For planning purposes, communities are divided into large urban areas, small communities of 25,000 or more, small communities of 2,500 to 25,000, communities of 2,500 or more within 20 miles of an urban central city, and rural and frontier (<2,500) communities.

Table 2-10 below includes the recommended minimum levels of service for Independence (a community of 2,500 to 25,000 within 20 miles of an urban central city-Salem), with an indication of whether the recommendation is met, partially met, or unmet.

**Table 2-10. Recommended Minimum Levels of Service**

Coordinate intercity senior and disabled services with intercity bus and van services open to the general public	Partially Met
Connect local public transportation and senior and disabled service to intercity bus services	Partially Met
Provide an accessible ride to anyone requesting service	Partially Met
Provide 1.7 annual hours of public transportation service per-capita with fixed-route, dial-a-ride, or other service types	Partially Met
Provide at least one accessible vehicle for every 40 hours of service	Partially Met
Provide one backup vehicle for every 3.5 vehicles	Partially Met
Provide daily peak hour commuter service to the core areas of the central city (Salem, Corvallis, or Albany)	Partially met
Provide a guaranteed ride home program to all users of the public transportation system and publicize it well	Unmet
Provide park-and-ride facilities along the transit corridors to meet reasonable peak and off-peak demand for such facilities	Unmet

**Table 2-10. Recommended Minimum Levels of Service**

Maintain vehicles and corresponding facilities in a cost-effective manner and replace vehicles when they reach suggested retirement age	Partially Met
Establish ridematching and demand management programs in communities of 5,000 where there are employers with 500 or more workers who are not already covered by a regional ridematching/demand management program	Not applicable

As shown in Table 2-10 above, several recommended transit services are partially available in Independence.

Recommended services not currently provided include daily peak-hour commuter services to Corvallis and Albany, a guaranteed ride home to users of public transportation, and park-and-ride facilities. Additionally, it is unlikely that the per capita hours of public transit service and fleet requirements are met. Unless additional services are provided, future predicted growth trends will result in an increase in unmet transit needs over time.

## Air Transportation

### Existing Facilities

The Independence State Airport is located on the northern edge of the City and accommodates light single- and multi-engine aircraft weighing less than or equal to 12,500 pounds<sup>2</sup> (see Figure 2 for the location of this airport). The airport is owned, operated, and maintained by the Oregon Department of Aviation. The airport has a design capacity of 103,000 aircraft operations per year and about 32,773 operations occurred from October 1995 through 1996 (Aron Faegre & Associates, 1997). The single north-south paved runway is 2,935 feet long by 60 feet wide and had medium intensity runway edge lights. As of 2005, approximately 142 aircraft were based at the airport, consisting of 134 single-engine, 3 multi-engine and 5 ultralights. As of 1999, the airport averaged 87 operations per day, with 71 percent being transient general aviation, 25 percent local general aviation and 4 percent air taxi.<sup>3</sup>

The airport does not have an instrument landing system, so operations are limited to visual flight rules (VFR). There is no scheduled service provided by commercial air carriers.

There is a highly successful residential airpark development located on the east side of the airport. The airpark currently has 90 homes with hangars and has attained national recognition. The zoning within the residential airpark includes a Residential Single Family Airpark Overlay zone, designed to minimize “exposure to crash hazards and high noise levels generated by air field operations by encouraging development which is compatible with the continued operation of airfields, and established airpark development” (Independence Development Code).

The City of Independence also has an Airport Safety and Compatibility Overlay Zone, intended to “support the continued operation and vitality of public use airports with only visual approaches by establishing compatibility and safety standards to promote air navigational safety at Independence State Airport and to reduce potential safety hazards for

<sup>2</sup> Source: Independence State Airport, Airport Layout Plan Report, Aron Faegre & Associates, 1997.

<sup>3</sup> Oregon Department of Aviation website database for Independence State Airport, March 15, 2007.

persons living, working or recreating near such public use airports.” The Overlay Zone includes an airport approach zone, a fan-shaped area extending from the end of the runway for a distance of 4,000 feet and to a width of 1,250. The Overlay Zone also includes an airport clear zone, a fan-shaped area extending from the edge of the airport for a distance of 1,000 feet and to a width of 312.5 feet. The width of both zones at the end of the runway is 250 feet. The northern zones are located mainly in Polk County but the southern zones extend over Independence. The southerly clear zone extends to about 500 feet south of Hoffman Road and the southerly approach zone extends to Monmouth Street (Oregon 51).

### **Existing and Future Airport Needs**

The Draft Independence State Airport: Airport Layout Plan (Aaron Faegre & Assoc., 1997) recommended a variety of improvements to the existing facility and projected future aircraft operations at the airport. Improvements needed to accommodate increased use of the airport were also given. The report should be consulted for complete information regarding the existing and future airport needs and recommendations.

The Airport Layout Plan forecast airport operations to increase from 32,773 to 50,400 per year, an increase of 54 percent. This level of operation corresponds to 7,560 operations per peak month, and 252 operations on an average day in the peak month. The total capacity of the airport was estimated at 97,000 operations, which means that by 2015 the airport will be operating at 56 percent of facility capacity.

A variety of maintenance, reconstruction, and new construction activities were also recommended including pavement maintenance, taxiway and main apron expansions, and the extension of Runway 16-34. The extension would involve adding 540 feet to the north end of Runway 16.

Currently, the airport is at capacity for land side facilities, with all available airport owned property utilized, including all available hangar space. It was recommended in the Airport Layout Plan that the airport owner acquire and reserve about 41 acres along the west side of Runway 16-34 for future general aviation parking and hangar development.

Other recommendations, as excepted from the 1998 TSP, would require specific actions by the City of Independence. They involve maintaining an airport overlay zone which coincides with the future approach surfaces and FAR Part 77 surfaces. Airport overlay zoning should conform with the Oregon Department of Aviation’s guidelines.

- Incorporate the Airport Layout Plan into the City of Independence Comprehensive Plans; and
- Designate Runway 34 as the calm wind runway in order to minimize noise exposure on nearby residential areas south of the airport. In addition to designating a calm wind runway, a review of airport operating procedures should be conducted to ensure that appropriate noise abatement procedures and standard traffic pattern elevations and locations are being utilized at the airport.

Independence supports the Independence Airport, but given the anticipated increase in future operations, which will reach approximately half of the airport capacity, the City believes that the conflicts between the airport and adjacent land uses will increase. As aircraft operations increase, so do the noise contour boundaries. While the City can discourage new inappropriate land uses from locating too close to the airport, existing residential areas will ultimately be affected by increases in airport operations. Independence believes there is a need to evaluate the impact of airport growth on the community and plan to minimize conflicts. Given such concerns, the City strongly supports reviews of, and changes in, operating procedures that result in lower noise impacts to the community.



## **Railroad Transportation**

### **Existing Rail Facilities and Operations**

Rail transportation service is currently provided in the City of Independence by the Willamette & Pacific (W&P) Railroad, which generally runs north-south through the community in the middle of the 2<sup>nd</sup> Street alignment. In 1993, W&P signed a 20-year lease covering 185 miles of Union Pacific (UP) Railroad branch lines in the western Willamette Valley. In 1995, Portland & Western (P&W) Railroad, a sister company, was formed to lease additional UP branches in the valley. The two railroads, which do business under the P&W banner, have since grown to operate 576 miles of railroad in northwestern Oregon, representing 20 percent of the state's rail system.

According to ODOT, in 1998, the line through Independence handled about 1 million gross ton miles yearly (a gross ton mile is one ton hauled one mile), a measurement that includes the weight of cars, contents, and locomotives. Since late 2002, when P&W leased the parallel Oregon Electric line on the east side of the Willamette River from BNSF Railway, traffic through Independence has declined somewhat from the 1998 level.

P&W's (and W&P's) goal is to maintain its Independence trackage, at a minimum, to Federal Railroad Administration Class 2 standards, which permits freight train operation at 25 mph, and passenger train operation at 30 mph. No rail passenger service is currently provided in Independence. The line provides freight service for a large variety of commodities including forest products, iron and steel products, feed grains, fertilizers, and some manufactured consumables, including food products.

During 2006 and entering into 2007, W&P has consistently operated one southbound and one northbound train daily, seven days each week along the line through Independence. The railroad operations are dictated by the needs of customers and actual schedules may vary from week-to-week. According to ODOT, the average size of these trains is around 50 cars and three locomotives, or 4,000 feet in length.

Due to the condition of the track, rail operations along the 2<sup>nd</sup> Street alignment are currently limited to 10 mph along this portion of the line. According to ODOT's Rail Division, the optimal train speed through Independence would be 25 mph. Any train speed increases in Independence will raise the importance of the road crossing safety issues described below.

### **Rail Crossings**

There are approximately 2.5 miles of track within the Independence UGB (see Figure 2), with nine at-grade street crossings. The rail line runs along the eastern edge of town, traversing some of the oldest sections of the City. The track runs down 2<sup>nd</sup> Street, and this section is about ¼ mile in length. At-grade crossings are located at:

- Stryker Road (gated with flashing lights);
- Polk Street (gated with flashing lights);
- Williams Street (gated with flashing lights);
- 'B' Street (passive-sign protected);
- 'C' Street (passive-sign protected);
- Monmouth Street (gated with flashing lights);
- 'D' Street (passive-sign protected);
- 'E' Street (passive-sign protected); and
- 'G' Street (gated with flashing lights).

The rail route runs parallel to one arterial (Main Street) and crosses two other arterials (Monmouth Street and Polk Street) and a collector street (Stryker Road). The configuration of the railroad, and arterial and collector streets does result in temporary interruptions on the

major east-west routes when trains pass through Independence. Interruptions in east-west traffic on Monmouth Street (Oregon 51) also leads to interruptions to north-south traffic on Main Street (Oregon 51).

Historically, there have been problems between the community of Independence and the railroad operators regarding line maintenance, especially pavement maintenance on 2<sup>nd</sup> Street. The community has long endured minimal response to its concerns from the former railroad owners. The trackway down the middle of 2<sup>nd</sup> Street is of particular importance to the community because of safety concerns and due to wear and tear on the roadway surface. Other community issues include the speed of trains through town; the frequency of railroad crossings, particularly the passively protected crossings; and compromised emergency response capabilities should a train become stalled on the tracks and block crossings. The fire and police stations are located west of the track, which gives them access to most of the city. However, trains can delay and / or cause detours for emergency vehicles trying to reach the eastern edge of town, including the downtown, waterfront park, residences and businesses.

#### **Rail Improvement Needs**

This section is largely excerpted from the 1998 TSP that evaluated the rail freight and rail passenger needs in Independence during the 20-year planning period. This information can be used to suggest ways that conflict between adjacent land uses and other transportation modes can be minimized and the future function of the railroad can be protected.

#### **Existing Improvement Needs**

Existing railroad needs include trackage improvement, at-grade crossing closures, minimization of future at-grade crossings, and minimization of conflicts with other transportation modes (mainly auto) and adjacent land uses. Particularly, 2<sup>nd</sup> Street between “B” and “E” downtown contains trackage that runs down the center of the roadway. The impact of heavy trains and insufficient pavement structure results in the rapid deterioration and poor condition of the pavement. Public safety, maintenance improvements, property access and emergency response capability have been identified as existing concerns.

#### **Growth in Freight Rail**

Rail freight traffic through Independence is predicted to increase marginally during the next 20 years. While P&W expects to see significant overall growth in traffic on its system, the Oregon Electric line across the river from Independence has displaced the western Willamette Valley line via Independence as the core north-south route. For the next 10 years, ODOT-Rail expects the west side Independence line to be the preferred conduit for rail transportation into and out of Polk and Yamhill Counties, even though a northern route exists between Newberg and the Portland area via Rex Hill. Rex Hill, however, is beset with heavy grades and curvature and various degrees of deferred track and bridge maintenance. P&W keeps the line serviceable as a detour for the Oregon Electric line; otherwise Rex Hill does not see regular daily use. Consequently, rail traffic through Independence is expected to mirror current volumes of one daily through train each direction seven days a week, augmented with switch engine visits from either Corvallis or McMinnville as dictated by needs of local businesses receiving freight by rail.

Longer term, 2027 and later, regional expansion of Portland-area commuter rail service can be expected to reach McMinnville via Rex Hill, and possibly be extended to Independence and Corvallis. If commuter rail service reaches Independence, the west side rail line through Independence will be upgraded from a slow-speed freight-only railroad into a relatively high-speed, well-maintained passenger line. In its improved state, the line will continue to carry freight indigenous to Polk and Yamhill Counties. Some additional through freight is likely to use the route as well, as public capital invested for passenger improvements will mitigate barriers that discourage through freight movements today.

The Oregon Transportation Plan (OTP) estimated rail freight increases for the state system at 2.5% per year for an increase of 60% in 20 years. How much of this rail freight growth Independence might see will depend mainly upon what public policies for improving rail passenger transportation are adopted and where they are applied. Public policies aside, projections of freight movement and volume are difficult because they are based on many unpredictable factors such as international trade patterns, competition, federal policies, foreign events, and customer needs.

#### **Future Rail Improvement Needs**

Although railroad activity should remain relatively flat or increase slightly during the next 20 years, increases in vehicular traffic could result in more railroad-related conflicts and could impair the function of the railroad and other elements of the transportation system. Railroads are beneficial to communities and careful planning can minimize conflicts. Typically, conflicts between railroad and urban area activities fall into six general types:

1. Safety;
2. Delays and increased operating costs for highway users;
3. Community barriers;
4. Environmental degradation;
5. Incompatible or inappropriate land use; and
6. Increased railroad operating costs and reduced efficiency (ODOT, 1994).

Future railroad needs are similar to existing railroad needs and include trackage improvement, minimization of future at-grade crossings, and minimization of conflicts with other transportation modes (mainly auto) and certain adjacent land uses. Public safety, property access, and emergency response capability will be future concerns. Given existing growth in Independence and rail freight volume, the issues and needs will increase over time.

Presently, it is expected that vacant industrial lands in Independence will be used by smaller businesses that typically do not ship by rail. Independence does not envision much local business and industrial use of the railroad during the next twenty years. However, the community recognizes the importance of rail to the regional economy and the potential public transportation uses, and other unforeseen uses that may develop during the next 40 years. Therefore, the community believes that current and future needs center around conflict minimization that protects the future functionality of the railroad and reduces ongoing conflicts with through-town train travel.

#### **Potential for Passenger Rail Service**

The Oregon Rail Passenger Policy and Plan (Cambridge Systematics, Inc., 1992) is a comprehensive long-range plan for rail passenger service that focused on intercity rail options, including commuter rail. One of the service corridors evaluated connected communities along the west side of the Willamette Valley. This route, called the Willamette Valley Interurban Service corridor, is the existing W&P / P&W Railroad which, at one time, connected Eugene and Portland via Monroe and Corvallis. The proposed service was planned to have more frequent stops, operate at lower speeds, and use electric propulsion. The study concluded by favoring improved conventional rail service and upgrading the high-speed rail corridor on Southern Pacific's (now UP's) main line, located east of the Willamette River. However, the study recommended the Interurban Service corridor should be considered in more depth as a part of transportation planning for the Willamette Valley. Cost-benefit comparisons between interurban train service and intercity bus service should be made. As mentioned earlier, while it is unlikely that rail passenger service to Independence will become viable during this planning period, it is logical and far-sighted to allow for the possibility in the future.

### **Pipeline and Water Transportation**

There are no regional pipelines in Independence. Monmouth's water mainline is carried on the Independence Bridge (owned and maintained by Marion County) across the Willamette River and traverses across the City on easements located on the old Valley and Siletz Railroad right-of-way. The sewage outfall lines of Monmouth and Independence join near the sewage lagoons. The outfall line is located north of Ash Creek and discharges to the Willamette River.

Independence does not currently have water transportation modes within the UGB. The City has a grant to study the feasibility of developing water transportation services as a part of recreational use of the Willamette River. The recreational planning focuses on connections between the riverfront parks in downtown Independence and Salem. The grant is supporting a bathymetric survey of the river to identify shoaled areas between Salem and Independence. This information will be used to identify suitable water-transport craft types and evaluate the location and amount of dredging that would be required to develop channels for larger crafts.

## **2.4 DEVELOPMENT AND EVALUATION OF ALTERNATIVES**

This section documents the analysis of anticipated future land development activities within the Independence UGB, and the growth in traffic volumes associated with this development. Included in this section are the following:

- Assessment of future growth for the planning horizon year of 2026 by land use type for each traffic analysis zone established within the UGB. A traffic analysis zone (or TAZ) is a relatively homogeneous geographic area for which demographic, socio-economic and land use data is aggregated for use in travel demand forecasting.
- Development of future intersection turning movement projections for the PM peak hour in 2026 at nine key intersections identified and previously discussed under "Existing Conditions."
- Evaluation of traffic operating performance at each intersection and identification of improvement needs.
- Assessment of two TSP alternatives including: No-Action and a System Improvement Alternative. An additional, longer-term alternative was also developed and assessed based on more intense and expansive land development assumptions.

### **2026 Land Development Expectations**

The purpose of this section is to provide a summary of potential future land use and development expectations in the City over the next 20 years to the planning horizon of 2026. The section includes a description of proposed traffic analysis zones (TAZs) for use in developing traffic projections, and provides data tables that describe future land use and development expectations.

#### **Traffic Analysis Zones**

The area within the City of Independence's UGB has been divided into 16 TAZs (see Figure 8). Polk County tax assessor data, along with the Independence Comprehensive Plan designations, have been gathered for each TAZ for the 2005 analysis base year. This data formed the foundation for estimating expected growth in residential, commercial, and industrial development within each TAZ between 2005 and 2026. This development data was used to generate estimated future trips, traveling to and from each TAZ, which were subsequently assigned to the surrounding street system to assess the impacts of traffic volume growth. The boundaries of each TAZ were selected based upon a variety of factors, including the location of major streets, the location of study intersections, and existing land uses.

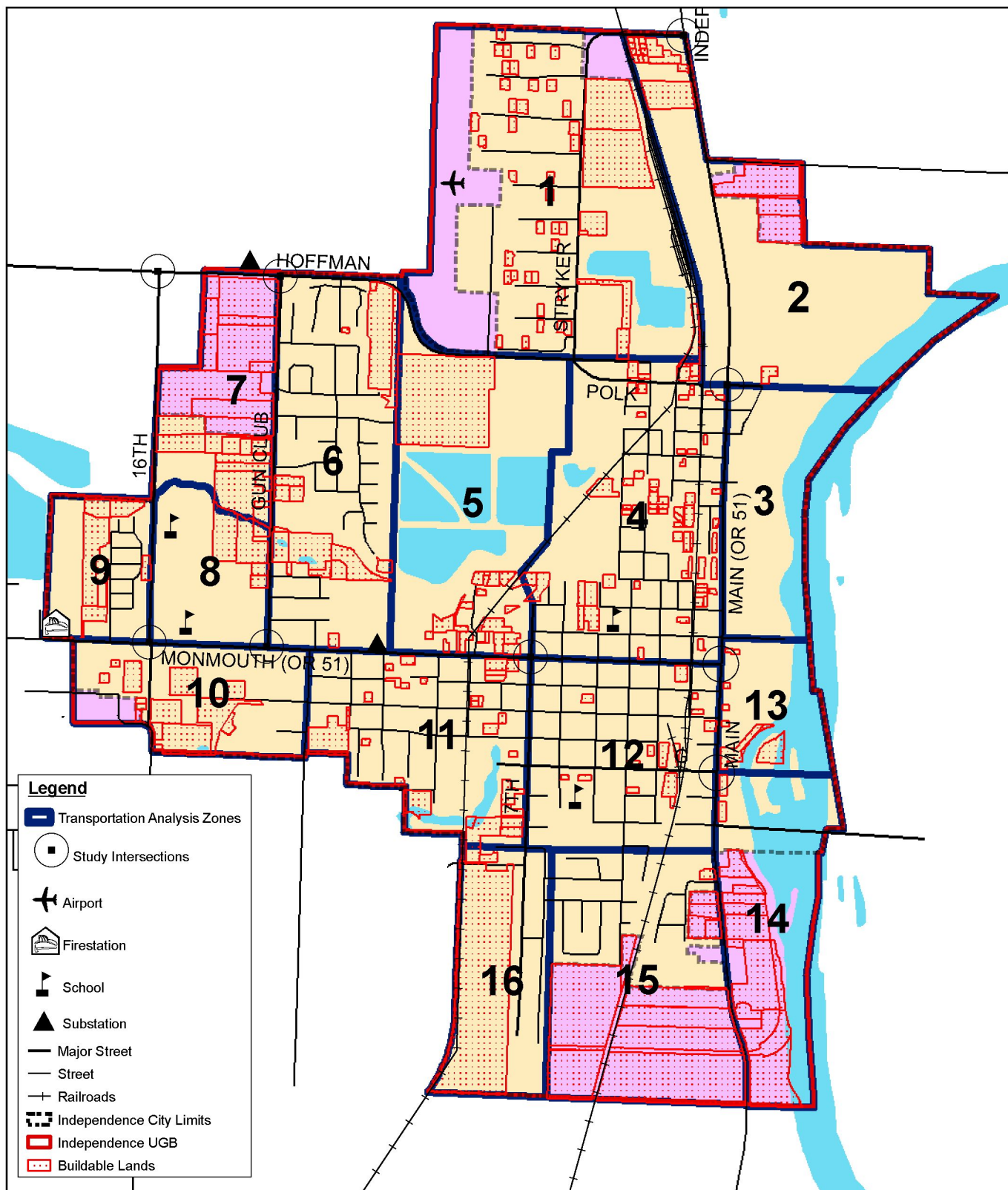

**Legend**

- Transportation Analysis Zones
- Study Intersections
- ✈ Airport
- 🏠 Firestation
- 🎓 School
- ▲ Substation
- Major Street
- Street
- + Railroads
- Independence City Limits
- Independence UGB
- Buildable Lands

**Parametrix**



**Geographic Data Standards:**  
 Projected Coordinate System:  
 NAD 1983 HARN StatePlane Oregon North

**Data Source(s):**  
 Mid-Willamette Valley Council of Governments  
 Polk County GIS

Date: November 2006

*This product is for informational purposes and may not have been prepared for legal, engineering or surveying purposes. Users of this information should review or consult the primary data and information source to ascertain the usability of this information.*

**Figure 8**  
**Traffic Analysis Zones**

INDEPENDENCE TSP

**This page intentionally left blank.**

### **Development of 2026 Community Data**

The development of 2026 community land use data was based on the methodology and constrained land information contained in the City of Independence Buildable Lands and Land Needs Report published by the Mid-Willamette Valley Council of Governments (COG) in 2000, coupled with data from the City of Independence and Polk County. Local government data sources included the 2005 Polk County tax assessor data, Polk County's estimate of future (2026) population for Independence, the Independence Comprehensive Plan designations, and aerial reconnaissance. This data and methodology were used to estimate future acreage of residential, commercial, and industrial development by TAZ.

The steps in this analysis process included:

1. Calculating the number of gross vacant acres by Comprehensive Plan designation,
2. Calculating the number of gross buildable acres by subtracting:
  - Physically constrained land that preclude future development, and
  - Land currently utilized for commercial, residential, or industrial buildings or uses, as identified through aerial reconnaissance and the Polk County tax assessor data.
3. Calculating the number of net residential buildable acres by:
  - Subtracting land for future public facilities, such as rights-of-way, and
  - Reducing the estimate of net buildable residential acres to be consistent with Polk County's 2026 Independence population estimate.

The following definitions and assumptions, borrowed from the COG report, were used in this analysis:

- Vacant land includes all commercial, industrial and residential parcels that are at least 5,000 square feet (.11 acres) in size with improvement values of less than \$5,000, as indicated by Polk County Tax Assessor data and the City of Independence Comprehensive Plan.
- Within the City limits, partially vacant land consists of residential parcels that are at least .5 acres in size with an improvement value of at least \$5,000, as indicated by Polk County Tax Assessor data. This analysis assumes that .25 acres of each of these residential parcels is devoted to the existing house, with the remainder considered vacant.
- Within the UGB but outside the City limits, partially vacant land consists of residential parcels that are at least 1 acre in size with improvement values of at least \$5,000, as indicated by Polk County Tax Assessor data. This analysis assumes that .5 acres of each of these residential parcels is devoted to the existing house, with the remainder considered vacant. The larger area attributed to these existing homes is intended to account for the presence of larger homes and an adjacent septic system serving the residences outside the City limits.
- Physically constrained land is considered unbuildable and is subtracted from the amount of gross vacant acres. For this analysis, physically constrained land includes wetlands, riparian buffers along Ash Creek, floodways identified on FEMA's Flood Insurance Rate Map, and areas with slopes in excess of 25 percent, as identified in the COG report.
- Public lands include land for public facilities such as municipal buildings and schools, and land for right-of-way, utilities, parks and open space. This analysis assumes that 27 percent of the gross buildable residential land will be dedicated for use as public facilities.

The following additional assumption was utilized for this report:

- Commercial and industrial development is assumed to occur on all appropriately planned gross buildable acreage.
- Residential development is assumed to occur on all appropriately planned gross buildable acreage, minus a population adjustment. The 2026 Polk County population estimate is 10,803, a 3,288 increase over the 2005 population of 7,515. Full residential buildout on all appropriately planned gross residential buildable acreage, utilizing the COG report's assumed 3.17 people per residential unit estimate, would produce a 2026 population increase of 7,553 (for a total 2026 population of 15,068). To make this development analysis consistent with the official Polk County 2026 population estimate, the net residential buildable acreage for each TAZ was reduced by 43.5 percent.

Table 2-11 shows the estimated acres of gross buildable and net buildable acreage, by Comprehensive Plan designation and TAZ, based on the above data sources, assumptions, and methodology. TAZ number 3 had no estimated development. Section B-4 of Appendix B identifies the net buildable acreage within each TAZ as "Buildable Lands." It is important to note that many of the residential parcels identified as "Buildable Lands" are partially vacant parcels which include an existing residence.

**Table 2-11. Future (2026) Community Development Data**

Traffic Analysis Zone	Comprehensive Plan Designation	Gross Buildable Acreage	Net Buildable Acreage
1	Low Density Residential	12.37	3.93
	Industrial	28.90	28.90
2	Medium Density Residential	20.13	6.40
	Low Density Residential	0.77	0.24
	Industrial	1.45	1.45
4	Medium Density Residential	7.34	2.33
	Low Density Residential	6.86	2.18
	Industrial	2.10	2.10
	Commercial	0.84	0.84
5	High Density Residential	0.57	0.18
	Medium Density Residential	5.19	1.65
	Industrial	29.37	29.37
	Commercial	0.78	0.78
6	Medium Density Residential	18.13	5.76
	Low Density Residential	4.74	1.50
7	Medium Density Residential	10.08	3.20
	Low Density Residential	53.53	17.01
8	Low Density Residential	9.57	3.04
9	High Density Residential	9.19	2.92
10	High Density Residential	4.67	1.49
	Low Density Residential	10.34	3.29
	Commercial	3.43	3.43



**Table 2-11. Future (2026) Community Development Data**

Traffic Analysis Zone	Comprehensive Plan Designation	Gross Buildable Acreage	Net Buildable Acreage
11	High Density Residential	0.15	0.05
	Medium Density Residential	8.44	2.68
	Low Density Residential	7.26	2.31
	Commercial	0.61	0.61
12	High Density Residential	0.17	0.05
	Low Density Residential	1.86	0.59
	Industrial	2.20	2.20
	Commercial	1.04	1.04
13	Industrial	3.44	3.44
	Commercial	0.59	0.59
14	Low Density Residential	23.77	7.55
	Commercial	1.01	1.01
15	Low Density Residential	91.02	28.92
16	Medium Density Residential	0.27	0.08
	Low Density Residential	44.69	14.20
<b>Total</b>		<b>426.85</b>	<b>187.33</b>

In addition to the 2026 estimate of buildable acreage, an estimate of buildable acreage was also developed assuming full build-out of all industrial, commercial, and residentially designated land within the existing Independence UGB. The difference between the 2026 estimate and the full build-out estimate is that the full build-out estimate is not constrained by Polk County’s official population projections for the City of Independence. The full build-out estimate assumes that the 43.5 percent of net residential buildable acreage that remained vacant in the 2026 projections would actually be developed for a target year beyond the planning horizon of the TSP (2042 was identified as the likely year of build-out). As discussed later in this section, full build-out analysis was used to determine what additional transportation improvements might be needed beyond the 20-year time frame of the TSP.

**Summary of Alternatives**

As noted above, two alternatives were evaluated for this TSP: a No Action Alternative and a System Improvement Alternative, both of which are focused on the 2026 planning horizon year. In addition, a land use alternative was developed to assess the implications of community development beyond the TSP’s planning period. The 2026 System Improvement Alternative represents full build-out of available industrial and commercial designated developable lands, and partial build-out of available developable residentially designated lands. The additional alternative represents full build-out of all developable land with commercial, industrial and residential designations. For planning purposes, this alternative was forecasted to occur by 2042.

Key elements of the No-Action and System Improvement Alternatives are presented below.

**No-Action Alternative**

This alternative assumes that no changes would occur to existing goals and policies, roadway functional classification, and roadway design standards. Local roads will be built as development occurs and the existing ordinances and standards would apply. Roadway maintenance will occur as needed in the community, but no significant improvements to the arterial or collector roadway system would be included. Bikeway, walkway, public transportation, airport, and water transportation needs will be guided by existing language in the Comprehensive Plans and other planning documents.

**System Improvement Alternative**

The system improvement alternative is intended to meet transportation system needs by formulating an overall plan that the City implements as growth and funding allows. Although the focus is on the street network, the other modes are also considered. This alternative includes long-term incremental improvements and expansion of all facets of the existing system. Independence would also continue to work closely with Monmouth, Polk County and ODOT in the development and implementation of the system improvement alternative.

**Future Traffic Operations**

Future traffic operations analysis was conducted for the two TSP alternatives, as well as for the 2042 land development alternative, both with and without necessary and appropriate improvements.

Future traffic volumes were estimated according to the Oregon Department of Transportation’s (ODOT) Transportation Analysis Procedures Manual (APM) (2006) guidelines for cumulative analysis. A more detailed discussion of the traffic forecasting methodology, key assumptions and copies of intersection analysis worksheets are included in Appendix B.

**No-Action Alternative Improvement Needs**

Table 2-12 summarizes the analysis results associated with the No-Action Alternative for the key study area intersections in the 2026 PM peak hour. Included in the table are the anticipated volume-to-capacity ratios based on projected future volumes and assuming no roadway system improvements; average delay per vehicle; level of service based on average delay; and a comparison between the projected traffic operations and the applicable threshold for identifying an operational problem. These thresholds vary depending upon roadway jurisdiction (e.g., City, County and/or ODOT) and location of the intersection based on the ODOT highway classification system for Oregon 51 (see Figure 3 for these classifications and Table 2-5 for specific standards). It should be noted that for city operated intersections, a volume-to-capacity ratio of 0.80 has been used to identify operational problems. This standard is recommended for adoption based on this TSP as described in Chapter 3.

As indicated in the table, six of the nine key study intersections would likely experience operational failure resulting in long delays to the traveling public. Locations that exceed their applicable threshold are identified in bold.

**Table 2-12. 2026 No-Action Alternative, Intersection Operations Analysis**

<b>Signalized Intersections</b>	<b>V/C Ratio</b>	<b>Average Delay (sec/veh.)</b>	<b>LOS</b>	<b>Operations Threshold</b>
Monmouth St. (OR 51) @ 16th Street	0.70	63.3	E	0.90
<b>Monmouth St. (OR 51) @ Gun Club Road</b>	<b>&gt;1.00</b>	<b>&gt;80.0</b>	<b>F</b>	<b>0.90</b>

**Table 2-12. 2026 No-Action Alternative, Intersection Operations Analysis**

Unsignalized Intersections	Critical Movement	Critical V/C Ratio	Critical Delay (sec/veh,)	Critical LOS	Operations Threshold
<b>Hoffman Road @ Gun Club Road</b>	<b>Northbound</b>	<b>0.81</b>	<b>45.4</b>	<b>E</b>	<b>0.80<sup>(1)</sup></b>
Hoffman Road @ 16th Street	Northbound	0.31	14.5	B	LOS C
<b>Monmouth St. (OR 51) @ 7th Street</b>	<b>Northbound</b>	<b>&gt;1.00</b>	<b>&gt;80.0</b>	<b>F</b>	<b>0.80</b>
	<b>Southbound</b>	<b>&gt;1.00</b>	<b>&gt;80.0</b>	<b>F</b>	<b>0.80</b>
<b>Main St. (OR 51) @ Polk Street</b>	<b>Eastbound</b>	<b>0.99</b>	<b>94.0</b>	<b>F</b>	<b>0.90</b>
	<b>Westbound</b>	<b>0.72</b>	<b>&gt;80.0</b>	<b>F</b>	<b>0.90</b>
Main St. (OR 51) @ Stryker Road	Northbound	0.04	9.0	A	0.90
	Eastbound	0.42	29.1	D	0.90
<b>Main St. (OR 51) @ Monmouth St. (OR 51)</b>	<b>Northbound</b>	<b>&gt;1.00</b>	<b>&gt;80.0</b>	<b>F</b>	<b>0.95</b>
	<b>Eastbound</b>	<b>&gt;1.00</b>	<b>&gt;80.0</b>	<b>F</b>	<b>0.95</b>
<b>Main St. @ 'G' Street</b>	<b>Eastbound</b>	<b>&gt;1.00</b>	<b>&gt;80.0</b>	<b>F</b>	<b>0.80<sup>(1)</sup></b>

Note 1: LOS means intersection level of service.

Note 2: "Critical Delay" and "Critical LOS" refers to the delay or LOS experienced for the specific intersection traffic movement listed

<sup>(1)</sup> Recommended standard.

Following is a summary of each intersections anticipated to experience operational problems based on 2026 traffic forecasts for the No Action Alternative:

- Monmouth Street (Oregon 51) at Gun Club Road: As an intersection located on a district level highway with a posted speed limit of <35 mph, the applicable operation standard is a maximum .90 V/C. Anticipated operations would exceed a V/C of >1.00. Major problem movements include all westbound and southbound movements at this signalized intersection.
- Hoffman Road at Gun Club Road: This location would only slightly exceed the proposed V/C threshold of 0.80 for the northbound, stop-controlled movement and is not considered to be a problem due to the potential variability of the forecasts. However, this location should be monitored over time to ensure that operational problems do not develop.
- Monmouth Street (Oregon 51) at 7th Street. As an intersection located on a district level highway with a posted speed limit of <35 mph, the applicable operation standard is a maximum .90 V/C. Anticipated operations would result in unacceptable northbound and southbound critical movements that exceed a V/C of 1.00.
- Main Street (Oregon 51) at Polk Street. As an intersection located on a district level highway with an Urban Business Area (UBA) segment designation, the applicable operation standard is a maximum V/C of 0.90. The No-Action Alternative would result in an unacceptable eastbound critical movement V/C of 0.99 and an acceptable westbound critical movement V/C of 0.72.

- Main Street (Oregon 51) at Monmouth Street (Oregon 51). As an intersection located on a district level highway with a Special Transportation Area (STA) segment designation, the applicable operation standard is a maximum V/C of 0.95. Anticipated operations would result in an unacceptable northbound and eastbound critical movement V/C of >1.00.
- Main Street (Oregon 51) at “G” Street. As a City of Independence major arterial, the recommended operational standard is a maximum V/C of 0.80. As shown on Table 2-11, the No-Action Alternative would result in an unacceptable V/C of >1.00.

**System Improvement Alternative**

Table 2-13 summarizes the analysis results associated with the 2026 System Improvement Alternative for the key study area intersections in the planning horizon PM peak hour. A key element of this improvement alternative is the development of a new east/west arterial street connecting Corvallis Road in Independence with Oregon 99W in Monmouth. This new east/west arterial street would be south of, and parallel to, Monmouth Street (Oregon 51). Currently, about half of the traffic volume on Monmouth Street (Oregon 51) represents through trips with origins and destinations outside of Independence. The development of this new east/west arterial, along with some anticipated traffic diversion to the Polk Street/Hoffman Road corridor, will result in a potentially significant diversion of existing and future traffic away from Monmouth Street (Oregon 51), thus reducing many of the anticipated operational problems. It is estimated that 80 percent of the through trips would divert from Monmouth Street (Oregon 51), which would represent about 70 percent of the traffic volume using the new arterial roadway.

Another significant project is a new directional circulator that will divert southbound to westbound Oregon 51 traffic away from the Main and Monmouth Street Intersection. The diverted traffic would travel westbound down “C” street, an existing one-way street, then turn southbound, somewhere between 2nd Street and 5th Street, to reconnect with Oregon 51 (Monmouth Street) west of the intersection with Main Street. This project protects the operations of the Monmouth Street / Main Street (Oregon 51) intersection.

As indicated in the table, all nine key study intersections would likely meet ODOT and City operating standards, including the intersection of Hoffman Road at 16th Street for which the applicable Polk County standard is assumed to be LOS C per the current county TSP.

A discussion of the proposed improvements along with a comparison between expected operations and street standards for the intersections follows:

- Monmouth Street (Oregon 51) at 16<sup>th</sup> Street: As an intersection located on a district level highway with a posted speed limit of ≤35 mph, the applicable operation standard is a maximum .90 V/C. With the significant diversion of traffic away from Monmouth Street, the anticipated V/C would be 0.52. No improvements are recommended at this location.

**Table 2-13. 2026 System Improvement Alternative, Intersection Operations Analysis**

Signalized Intersections	V/C Ratio	Average Delay (sec/veh.)	LOS	Operations Threshold
Monmouth St. (OR 51) @ 16th Street	0.52	29.3	C	0.90
Monmouth St. (OR 51) @ Gun Club Road	0.65	31.5	C	0.90

**Table 2-13. 2026 System Improvement Alternative, Intersection Operations Analysis**

Unsignalized Intersections	Critical Movement	Critical V/C Ratio	Critical Delay (sec/veh,)	Critical LOS	Operations Threshold
Hoffman Road @ Gun Club Road	Northbound	0.51	32.6	D	0.80 <sup>(1)</sup>
Hoffman Road @ 16th Street	Northbound	0.28	14.3	C	LOS C
Monmouth St. (OR 51) @ 7th Street	Northbound	0.57	37.1	E	0.80
	Southbound	0.49	27.3	D	0.80
Main St. (OR 51) @ Polk Street	Eastbound	0.47	36.7	E	0.90
	Westbound	0.47	48.8	E	0.90
Main St. (OR 51) @ Stryker Road	Northbound	0.02	8.9	A	0.90
	Eastbound	0.51	28.7	D	0.90
Main St. (OR 51) @ Monmouth St. (OR 51)	Northbound	0.71	19.8	C	0.95
	Eastbound	0.35	12.4	B	0.95
Main St. @ 'G' Street	Eastbound	0.43	22.0	C	0.80 <sup>(1)</sup>

Note 1: LOS means intersection level of service.

Note 2: "Critical Delay" and "Critical LOS" refers to the delay or LOS experienced for the specific intersection traffic movement listed

<sup>(1)</sup> Recommended standard.

- Monmouth Street (Oregon 51) at Gun Club Road: As an intersection located on a district level highway with a posted speed limit of <35 mph, the applicable operation standard is a maximum .90 V/C. With the addition of a southbound left turn lane, an acceptable V/C of 0.65 is anticipated. [Note: a southbound left turn lane was added to this intersection after this analysis was completed].
- Hoffman Road at Gun Club Road: As a City of Independence minor arterial, the recommended operational standard is a maximum V/C of 0.80. The addition of a northbound left turn lane at this intersection would result in an acceptable V/C of 0.51.
- Hoffman Road at 16th Street. As a Polk County roadway, the applicable operation standard is a minimum of LOS C, which is met. No improvements are recommended at this location.
- Monmouth Street (Oregon 51) at 7th Street. As an intersection located on a district level highway with a posted speed limit of <35 mph, the applicable operation standard is a maximum V/C of 0.80. The addition of a northbound left turn lane and a reduction in through traffic volumes along Monmouth Street associated with the new east/west arterial road would result in an acceptable V/C of 0.57 for northbound traffic and 0.49 southbound for southbound traffic.
- Main Street (Oregon 51) at Polk Street. As an intersection located on a district level highway with a Urban Business Area (UBA) segment designation, the applicable operation standard is a maximum V/C of 0.90. The addition of an eastbound left turn lane would result in an acceptable eastbound critical movement V/C of 0.47 and an acceptable westbound critical movement V/C of 0.47.

- Main Street (Oregon 51) at Stryker Road. As an intersection located on a district level highway with an Urban Business Area (UBA) segment designation, the applicable operation standard is a maximum V/C of 0.90. While no improvements would be required at this intersection, a reduction in through traffic volumes along Main Street would result in an acceptable northbound critical movement V/C of 0.02 and an acceptable eastbound critical movement V/C of 0.51.
- Main Street (Oregon 51) at Monmouth Street (Oregon 51). As an intersection located on a district level highway with a Special Transportation Area (STA) segment designation, the applicable operation standard is a maximum V/C of 0.95. Development of the proposed directional circulator would help to reduce southbound right turning volumes at this location along with the reduction in through volumes along Monmouth Street attributable to the proposed east/west arterial road on the south side of town. It is anticipated that these improvements would result in an acceptable northbound critical movement V/C of 0.71 and acceptable eastbound critical movement V/C of 0.35.
- Main Street (Oregon 51) at “G” Street. As a City of Independence major arterial, the recommended operational standard is a maximum V/C of 0.80. With the addition of an eastbound left turn lane and the diversion of through traffic to the new east/west arterial, it is expected that this intersection would operate at an acceptable V/C of 0.43.

**2042 Full Build-out Alternative (Without Improvements)**

Table 2-14 summarizes the analysis results associated with the Full UGB Build-out Alternative (without Improvements) for the key study area intersections in the 2042 PM peak hour. As indicated in the table, only three key study intersections would likely meet ODOT and City operating standards. This alternative would likely result in operational failure in many locations, resulting in long delays to the traveling public.

Following is a summary of each intersections anticipated to experience operational problems based on 2042 traffic forecasts for the No Action Alternative:

- Monmouth Street (Oregon 51) at Gun Club Road: As an intersection located on a district level highway with a posted speed limit of  $\leq 35$  mph, the applicable operation standard is a maximum .90 V/C. Anticipated operations would exceed a V/C of  $>1.00$ . Major problem movements include all westbound and southbound movements at this signalized intersection.

**Table 2-14. 2042 Full UGB Build-out Alternative (Without Improvements), Intersection Operations Analysis**

Signalized Intersections		V/C Ratio	Average Delay (sec/veh.)	LOS	Operations Threshold
Monmouth St. (OR 51) @ 16th Street		0.83		F	0.90
<b>Monmouth St. (OR 51) @ Gun Club Road</b>		<b>&gt;1.00</b>	<b>&gt;80.0</b>	<b>F</b>	<b>0.90</b>
Unsignalized Intersections	Critical Movement	Critical V/C Ratio	Critical Delay (sec/veh.)	Critical LOS	Operations Threshold
<b>Hoffman Road @ Gun Club Road</b>	<b>Northbound</b>	<b>&gt;1.00</b>	<b>&gt;80.0</b>	<b>F</b>	<b>0.80<sup>(1)</sup></b>
Hoffman Road @ 16th Street	Northbound	0.38	16.3	C	LOS C

**Table 2-14. 2042 Full UGB Build-out Alternative (Without Improvements), Intersection Operations Analysis**

Monmouth St. (OR 51) @ 7th Street	Northbound	>1.00	>80.0	F	0.80
	Southbound	>1.00	>80.0	F	0.80
Main St. (OR 51) @ Polk Street	Eastbound	>1.00	>80.0	F	0.90
	Westbound	>1.00	>80.0	F	0.90
Main St. (OR 51) @ Stryker Road	Northbound	0.08	9.5	A	0.90
	Eastbound	0.70	63.1	F	0.90
Main St. (OR 51) @ Monmouth St. (OR 51)	Northbound	>1.00	>80.0	F	0.95
	Eastbound	>1.00	>80.0	F	0.95
Main St. @ 'G' Street	Eastbound	>1.00	>80.0	F	0.80 <sup>(1)</sup>

Note 1: LOS means intersection level of service.

Note 2: "Critical Delay" and "Critical LOS" refers to the delay or LOS experienced for the specific intersection traffic movement listed

<sup>(1)</sup> Recommended standard.

- Hoffman Road at Gun Club Road: As a City of Independence minor arterial, the recommended operation standard is a maximum V/C of 0.80. With the expected increase in traffic volumes by 2042, this intersection is anticipated to operate with an unacceptable V/C of >1.00 for the northbound stop-controlled movement.
- Monmouth Street (Oregon 51) at 7th Street. As an intersection located on a district level highway with a posted speed limit of <35 mph, the applicable operation standard is a maximum V/C of 0.80. With Full UGB Build-out Alternative (without Improvements) an unacceptable V/C of >1.00 would be experienced for northbound and southbound critical movements.
- Main Street (Oregon 51) at Polk Street. As an intersection located on a district level highway with a Urban Business Area (UBA) segment designation, the applicable operation standard is a maximum V/C of 0.90. With the Full UGB Build-out Alternative (without improvements) this intersection is expected to operate with a V/C of > 1.00 for the critical eastbound and westbound movements.
- Main Street (Oregon 51) at Monmouth Street (Oregon 51). As an intersection located on a district level highway with a Special Transportation Area (STA) segment designation, the applicable operation standard is a maximum V/C of 0.95. With the Full UGB Build-out Alternative (without improvements) this intersection would operate for a V/C in excess of 1.00 for both the northbound and eastbound critical movements.
- Main Street (Oregon 51) at "G" Street. As a City of Independence major arterial, the recommended operational standard is a maximum V/C of 0.80. With Full UGB Build-out and no system improvements, the intersection is expected to operate with an unacceptable V/C of >1.00.

**2042 Full Build-out Alternative (With Improvements)**

Table 2-15 summarizes the analysis results associated with the Full Build-out Alternative (With Improvements) for key study area intersections in the 2042 PM peak hour. As indicated in the table, all nine key study intersections would likely meet ODOT and City operating standards.

A discussion of the proposed improvements along with a comparison between expected operations and street standards for the intersections follows:

- Monmouth Street (Oregon 51) at 16th Street: With the significant diversion of traffic away from Monmouth Street onto the proposed new east/west arterial, the anticipated V/C would be 0.61. No improvements are recommended at this location.
- Monmouth Street (Oregon 51) at Gun Club Road: To mitigate anticipated 2026 traffic operational problems the addition of a southbound left turn was proposed. This improvement would be sufficient to meet the expected increase in traffic volumes by 2042. Analysis results show an acceptable V/C of 0.74. [Note: a southbound left turn lane was added to this intersection after this analysis was completed].
- Hoffman Road at Gun Club Road: As a City of Independence minor arterial, the recommended operational standard is a maximum V/C of 0.80. The addition of a northbound left turn lane at this intersection would result in an acceptable V/C of 0.64.
- Hoffman Road at 16th Street. As a Polk County roadway, the applicable operation standard is a minimum of LOS C, which is met. No improvements are recommended at this location.

**Table 2-15. 2042 Full UGB Build-out Alternative (With Improvements), Intersection Operations Analysis**

Signalized Intersections		V/C Ratio	Average Delay (sec/veh.)	LOS	Operations Threshold
Monmouth St. (OR 51) @ 16th Street		0.61	31.5	C	0.90
Monmouth St. (OR 51) @ Gun Club Road		0.74	35.0	D	0.90
Main St. (OR 51) @ Polk Street		0.79	18.6	B	0.90
Main St. (OR 51) @ Monmouth St. (OR 51)		0.79	15.6	B	0.95

Unsignalized Intersections	Critical Movement	Critical V/C Ratio	Critical Delay (sec/veh.)	Critical LOS	Operations Threshold
Hoffman Road @ Gun Club Road	Northbound Left	0.64	48.1	E	0.80 <sup>(1)</sup>
Hoffman Road @ 16th Street	Northbound	0.33	16.4	C	LOS C
Monmouth St. (OR 51) @ 7th Street	Northbound Left	0.61	80.2	F	0.80
	Southbound	0.71	49.3	E	0.80
Main St. (OR 51) @ Stryker Road	Northbound	0.04	9.3	A	0.90
	Eastbound	0.71	52.6	F	0.90
Main St. @ 'G' Street	Eastbound Left	0.49	41.3	E	0.80 <sup>(1)</sup>

Note 1: LOS means intersection level of service.

Note 2: "Critical Delay" and "Critical LOS" refers to the delay or LOS experienced for the specific intersection traffic movement listed  
(1) Recommended standard.



- Monmouth Street (Oregon 51) at 7th Street. As an intersection located on a district level highway with a posted speed limit of <35 mph, the applicable operation standard is a maximum V/C of 0.80. The addition of a northbound left turn lane and a reduction in through traffic volumes along Monmouth Street associated with the new east/west arterial road would result in an acceptable V/C of 0.61 for northbound traffic and 0.71 southbound for southbound traffic.
- Main Street (Oregon 51) at Polk Street. As an intersection located on a district level highway with an Urban Business Area (UBA) segment designation, the applicable operation standard is a maximum V/C of 0.90. Analysis indicates that the appropriate improvement to accommodate 2042 peak hour traffic volumes would be the installation of a traffic signal. This improvement would result in an acceptable V/C of 0.79 for the overall intersection.
- Main Street (Oregon 51) at Monmouth Street (Oregon 51). As an intersection located on a district level highway with a Special Transportation Area (STA) segment designation, the applicable operation standard is a maximum V/C of 0.95. Development of the proposed directional circulator would help to reduce southbound right turning volumes at this location along with the reduction in through volumes along Monmouth Street attributable to the proposed east/west arterial road on the south side of town. In addition, to accommodate 2042 peak period volumes, installation of a traffic signal would be appropriate. It is anticipated that these improvements would result in an acceptable V/C of 0.79 for the overall intersection.
- Main Street (Oregon 51) at “G” Street. As a City of Independence major arterial, the recommended operational standard is a maximum V/C of 0.80. With the addition of an eastbound left turn lane and the diversion of through traffic to the new east/west arterial, it is expected that this intersection would operate at an acceptable V/C of 0.49.

#### **Summary of Future Roadway Capacity Improvement Needs**

The analysis of existing and future transportation needs showed that as growth and development occur in Independence and the Willamette Valley, improvements to and expansions of the existing transportation system will be necessary. Identified needs include:

- Increasing capacity on the street network;
- Developing alternative collector / arterial routes to move traffic across and through town;
- Providing access to new developments, reducing conflicts between adjacent land uses and rail and air modes;
- Protecting the function of rail and air modes;
- Improving the existing walkways;
- Amending and implementing the bikeway plan; and
- Meeting growing and changing public transportation needs.

The No-Action Alternative is unacceptable because it fails to provide a safe, convenient, and economic transportation system. Independence is projected to grow significantly during the next twenty years and a piecemeal approach to transportation system planning will not result in the integrated network that is needed. It is crucial that Independence develop collector and arterial routes that provide alternatives for through and cross-town traffic and coordinate with the Monmouth, Polk County and ODOT systems. Railroad and airport modes and adjacent land uses and other transportation modes will also be better accommodated by the System Improvement Alternative.

**This page intentionally left blank.**

### 3. TRANSPORTATION SYSTEM PLAN

This section changes existing transportation goals and policies, and transportation system elements, which will improve the transportation system and meet the transportation needs of the community for the next twenty years. The section begins with the general transportation goals and objectives, followed by a plan for each system element.

#### 3.1 TRANSPORTATION GOALS, OBJECTIVES AND POLICIES

The following goals and policies were developed from the transportation goals and policies articulated in the Independence Comprehensive Plan, and were included nearly verbatim in the 1998 Independence Comprehensive Plan. They reflect state and federal legislation, as well as growth-related changes that have occurred in the City over the past few years. These goals and policies represent the community's vision of a system of transportation facilities and services that provide for local needs and maintain the City's commitment to managing growth and preserving quality of life. These transportation goals and objectives provided the overall guidance necessary to produce all other elements of this study. These goals and policies have guided the development of specific recommendations in the TSP.

Specific recommendations for each mode of transportation are presented in the following sections. A synopsis of all recommendations along with estimated costs is summarized at the end of this chapter.

**Goal: To provide a balanced, multi-modal, safe, convenient, and efficient transportation system for Independence.**

**Objectives:**

1. Independence shall develop a coordinated transportation system which facilitates the mobility and accessibility of community residents, and encourages alternatives to and reduced reliance upon the automobile.
2. Independence will protect the character of the Historic District from adverse impacts related to changes in the transportation system.
3. Independence shall consider access to public transit in making deliberations on residential development patterns.
4. Independence shall promote the development and maintenance of all transportation modes including bikeways, pedestrian ways, and public transportation to all planned land uses.
5. Independence shall encourage transportation modes which are energy efficient and enhance the air, noise, and visual environment of the community.
6. Independence shall cooperate with and support regional public transportation planning efforts.
7. Independence shall promote and give high priority to bike and pedestrian ways in the downtown area, and in the vicinity of schools and parks.
8. Independence shall protect the function of air and rail facilities in the City and develop and implement strategies that minimize conflicts with other transportation modes and adjacent land uses.
9. Independence shall cooperate with the Oregon Department of Aviation in the development and implementation of the goals of the Independence State Airport Layout Plan, 1998-2015.

10. Independence will coordinate with the Oregon Department of Transportation and Polk County in the planning and provision of transportation services and in the implementation of the ODOT State Transportation Improvement Program.
11. Independence will coordinate with affected transportation facility or service providers whenever a proposal for a plan or regulation amendment or development action would significantly affect a transportation facility.
12. Independence shall utilize the Transportation System Plan for guidance in all land use planing and project development activities.
13. Independence shall use tools such as performance standards to protect transportation facilities, corridors, and sites for their intended functions as identified in this plan.
14. Independence shall develop land use regulations and subdivision ordinances that allow needed transportation facilities and improvements and encourage development patterns that are friendly to pedestrians, bicyclists and public transportation users.

The goals and objectives of the Independence-Monmouth Comprehensive Bicycle Master Plan, adopted December 1991, are included by reference.

### 3.2 ROADWAY ELEMENT

This section documents an assessment of needs, deficiencies, policies and improvement recommendations affecting the street system within the Independence Urban Growth Boundary (UGB). Included is an evaluation of needs and deficiencies in the existing and projected future (2026) system, a discussion of longer-term roadway improvement needs based on full community build-out (2042), and a summary of specific recommendations for managing, enhancing and expanding the roadway system. More specifically, this chapter addresses:

- Summary of street system deficiencies
- Recommendations for:
  - Street standards
  - Access management
  - Traffic impact analysis
  - New roadway recommendations
  - Roadway capacity improvements
  - Roadway safety improvements
- Discussion of potential improvement needs beyond the 20-year TSP planning horizon

#### **Summary of Street System Deficiencies**

Analysis of the current road system and an assessment of potential future growth in traffic volumes has indicated that there are many existing and likely future roadway system needs and deficiencies. Segregated into different time periods, these needs and deficiencies can be summarized as follows.

#### **Roadway System Needs**

##### ***Existing***

In general, the existing Independence roadway system meets local and through trip traffic needs with minimal delays. However, several traffic safety issues have been identified related to the existing rail tracks on 2nd Street, pedestrian issues at Central High School, and gaps in the pedestrian and bike networks.

### **Future 2026**

By 2026, population and job increases within the Independence UGB will result in significant increases in local and commuter traffic. The impacts of these new local trips, when combined with an increase in trips through the community, are expected to result in significant congestion at several locations in the Independence road network. To avoid these future congestion problems, a new east/west arterial roadway was evaluated, along with north/south collector road extensions and/or improvements to connect the new arterial with the rest of the City's road network. Additionally, several intersection-specific improvement options have been considered.

### **Future 2042**

By 2042, additional population growth and an expected further increase in through trips will strain the traffic network. In addition to a new east-west arterial, collector roads, and the intersection-specific improvements mentioned above, traffic signal installation will be needed at the intersections of Main Street and Polk Street and Main Street and Monmouth Street.

## **Roadway System Improvement**

This section presents roadway system improvement recommendations for the 20-year planning horizon of this TSP. The section also includes possible additional improvements that may be needed to accommodate 2042 traffic volumes. Recommendations in this chapter cover the following topics:

- Street standards
- Access management
- Traffic impact analysis
- New roadway recommendations
- Roadway capacity improvements
- Roadway safety improvements
- Other roadway system policy recommendations

### **Street Standards**

The 1998 City of Independence TSP established street standards for Major and Minor Arterials, Collector and Local Service streets. These standards covered right-of-way and curb-to-curb widths, and regulations pertaining to moving lanes, turn lanes, bike lanes, parking lanes and sidewalks by street designation. The standards did not make reference to planting strips. With adoption of this TSP update, parking along Major and Minor Arterials is no longer prohibited, and is instead subject to City approval. Local Service street standards have also been updated, to encourage narrower streets and allow parking on both sides (see below and Table 3-1). To provide a safer and more convenient pedestrian environment, as well as to ensure compliance with ADA requirements, sidewalk widths on Collector Streets and Local Service Streets were increased from five feet to six feet, and planting strips are now required for all streets other than Local Service streets. The remaining street standards are unchanged. Table 3-1 reflects these changes and will be incorporated into an amended Independence Development Code.

### **Major Arterial Streets**

Oregon 51 comprises the majority of Major Arterial streets within the City of Independence. Because Oregon 51 is a state highway, state highway standards, rather than local street standards, apply to this roadway. South of Monmouth Street (Oregon 51), Main Street / Corvallis Road comprises the only non-highway roadway with a Major Arterial designation,

and local street standards apply to it. Major Arterial street standards include 84 feet of right-of-way; 60 feet of curb-to-curb width; between two to four moving lanes; turn lanes where needed to meet intersection V/C standards; two six foot bike lanes; parking subject to City approval; two six foot sidewalks; and two six foot planting strips.

#### **Minor Arterial Streets**

Two travel routes within Independence have Minor Arterial designations: the Polk Street / Hoffman Road corridor and Gun Club Road. The Polk Street / Hoffman Road corridor provides an alternate connection between Oregon 51 (Main Street) in Independence and Oregon 99W in Monmouth. Gun Club Road connects the Polk Street / Hoffman Road corridor with Oregon 51 (Monmouth Street).

Minor Arterial street standards include 66 feet of right-of-way; 36 feet of curb-to-curb width; two moving lanes; turn lanes where needed to meet intersection V/C standards; two six foot bike lanes; parking subject to City approval; two six foot sidewalks; and two six foot planting strips.

#### **Collector Streets**

A network of Collector streets exist throughout the City of Independence. Collector street standards include 66 feet of right-of-way; 36 feet of curb-to-curb width; two moving lanes; and turn lanes where needed to meet intersection V/C standards. Bicyclists and vehicles share the roadway on Collector streets with less than 2,000 Average Daily Traffic (ADT) volumes, and parking is allowed on both sides of the roadway. The City of Independence determines, on a case-by-case basis, whether to remove parking and create bike lanes on Collector streets with greater than 2,000 ADT volumes. Collector streets are required to have two six foot sidewalks and two five foot planting strips.

#### **Local Service Streets**

The TPR [660-12-045(7)] requires local governments to establish street standards that minimize pavement width and total right-of-way, consistent with the operational needs of the facility. The intent of this standard is to encourage local government to consider and reduce excessive standards in order to reduce construction costs, provide for more efficient use of urban land, provide emergency vehicle access while discouraging inappropriate traffic volumes and speeds, and accommodate convenient bicycle and pedestrian circulation.

In the 1998 TSP, Local Service street standards in Independence varied significantly depending on the operational needs of the roadways. The standards were a 36 foot wide curb-to-curb standard (60 foot right-of-way) for Local Service streets serving over 20 dwelling units and a 28 foot wide curb-to-curb standard (50 foot right-of-way) for Local Service streets and cul-de-sacs serving less than 20 dwelling units. Local Service streets serving over 20 dwelling units allowed parking on both sides of the street, whereas Local Service streets serving under 20 dwelling units allowed parking on only one side of the street. All Local Service streets had a shared travel lane for bicyclists and vehicles and two, five foot sidewalks. Turn lanes were not allowed on Local Service streets.

Based on a review of the operations of Local Service streets, it has become apparent that 28 foot curb-to-curb width Local Service streets do a better job of meeting TPR goals than their 36 foot wide counterparts. These goals include reducing construction costs, providing for more efficient use of urban land, providing emergency vehicle access while discouraging inappropriate traffic volumes and speeds, and accommodating convenient bicycle and pedestrian circulation. It has also become apparent that allowing parking on both sides of these streets reduces travel speeds, improves pedestrian and bicyclist safety, provides more convenient access to parking, and reduces the need for police enforcement. Therefore, a new 28 foot wide (52 foot right-of-way) street design standard, with parking on both sides of the

street, will apply to all Local Service streets, except as noted below. The City may require up to 36 foot wide (60 foot right-of-way) Local Service streets in or along high density residential, industrial or commercially zoned areas, or those expected to exceed 400 ADT. As discussed above, Local Service streets are also required to have two six foot sidewalks and are allowed, but not required, to have planting strips.

**Table 3-1. Independence Street Design Standards**

	Major Arterial Streets	Minor Arterial Streets	Collector Streets	Local Streets <sup>(1)</sup>
Right-of-way width	84 feet <sup>(2)</sup>	66 feet <sup>(2)</sup>	66 feet <sup>(2)</sup>	52 feet
Curb-to-curb width	60 feet	36 feet	36 feet	28 feet
Moving Lanes	2-4	2	2	2
Turn Lanes	<sup>(3)</sup>	<sup>(3)</sup>	<sup>(3)</sup>	0
Bike Lanes	2 @ 6'	2 @ 6'	<sup>(4)</sup>	Shared
Parking Lanes	<sup>(5)</sup>	<sup>(5)</sup>	<sup>(4)</sup>	2 sides
Sidewalks	2 @ 6'	2 @ 6'	2 @ 6'	2 @ 6'
Planting Strips <sup>(6)</sup>	2 @ 6'	2 @ 6'	2 @ 5'	Allowed

(1) The City may require up to 36 foot wide (60 foot right-of-way) Local Service streets in or along high density residential, industrial or commercially zoned areas, or those expected to exceed 400 ADT.

(2) Additional right-of-way and roadway improvements may be required at major intersections to provide for turn lanes.

(3) At all intersections where separate lanes are needed due to volume of turning movement activity.

(4) Collectors with < 2,000 ADT can accommodate on-street parking and shared use of road space by bicyclists and motor vehicles. These shared roadways will be designated with "sharrows." "Sharrows" are markings painted directly onto the road to promote the awareness that the road is a shared traffic lane to be used by both motorists and bicyclists. For collectors with > 2,000 ADT the city will study the need to eliminate on-street parking and provide bike lanes.

(5) The City of Independence may allow parking along sections of Major and Minor Arterial Streets, balancing the needs for accessibility to property, public safety, bicycle facilities, and roadway congestion. Parking allowances will be evaluated on an on-going basis as a part of roadway projects.

(6) Planting strips are encouraged, but not required, along Local Service streets. If built along Local Service streets, planting strips should be at least 4 feet wide, to accommodate tree plantings. In commercially zoned areas, the City may require wider sidewalks which encroach into the planting strip area.

### **Access Management Policy**

The goal of access management is to protect a street for its intended function by reducing the potential for conflicts between through-moving and local property access traffic. In Independence, access management is a tool that can be used to ensure that the TSP goals and objectives related to mobility and safety are preserved for the city's arterial and collector system.

The City, in cooperation with ODOT and Polk County, can achieve the following objectives through a coordinated approach to access management:

- Maintain an acceptable level of service (good mobility)
- Minimize capital costs
- Improve safety by minimizing potential conflict points
- Improve bicycle/pedestrian mobility

### **Access Management Policies**

Guidelines for access management are previously defined in the street design standards. The City achieves access management objectives through application of its development code. While existing spacing may already vary from recommended guidelines, the city will require the standards described in the TSP of all new development and encourage the consolidation of accesses in developed areas wherever possible.

The following are examples of access management techniques that will be used to accomplish the above objectives:

- Common driveways (sharing access with adjacent properties);
- Providing access to collector and local streets;
- Encourage connections between adjacent properties;
- Construct local service roads; and
- Align opposing driveways.

The City will remain flexible in its response to future development proposals on its Arterial/Collector streets, considering creative access solutions but maintaining a firm commitment to negotiating agreements that uphold the objectives of safety and mobility.

#### **Action Strategies for Access Management**

Oregon 51 presents important challenges related to reconciling the needs of past and future commercial development along the roadway with their intended function of carrying through traffic. In light of these competing demands on the arterial, the city will work with adjacent property owners to develop creative approaches to access management.

Although the state has jurisdiction over the highway itself, the city has control over land adjacent to the highway, and thus, has significant influence over access demands. Because of the overlapping jurisdictions, all development proposals that impact the state highways will be submitted to ODOT for review.

Coordination with Polk County and the City of Monmouth will also be important to develop a coordinated access management strategy for Hoffman Road, a minor arterial that provides a significant level of east/west mobility to both cities including the northern portion of City of Independence's UGB.

While the street network plan identifies certain future collector, minor arterial, and arterial streets of particular importance for traffic circulation, most local streets will be built as development occurs. The City will require local streets to connect with existing and planned streets wherever possible. Multiple access points, achieved through a well connected street network, are important to ensure that emergency services are not cut off and that local access is not eliminated or greatly lengthened in the event that one access is closed. Further, a well connected street network, with numerous alternative routes, reduces the volume of traffic on any one route and provides a more bicycle/pedestrian friendly environment.

This TSP includes the following access management standards that are continued from the 1998 TSP:

- **For major and minor arterials** – When pre-existing patterns of land ownership preclude the application of spacing standards, the city will encourage property owners to share private drives or to obtain access via the local and/or collector street system wherever feasible.
- **For collector streets** – Access to collectors is permitted by both streets and private drives. However, the city will encourage property owners to minimize access to collector streets according to the following guidelines: on-site vehicle turn-arounds, adequate off-street parking, safe intersection sight distance, and safe off-set distance between intersections on opposing sides of the street. The city will encourage combined access to collector streets wherever practical.
- **For local streets** – A well-connected local street network is important for convenient bicycle and pedestrian access. Cul-de-sac streets will continue to be discouraged in favor of establishing connections with existing or planned streets. Because local streets serve a



wide range of uses, including neighborhood play areas, the city will explore options to discourage “through” traffic and speeds in excess of 25 mph. Local streets that include design features such as curves and “T” intersection may be a useful means of reducing conflicts and discouraging through traffic.

These standards are largely absent from the Independence Development Code and should be added. The state highway access standards in the Independence Development Code are not consistent with current standards as found in the Oregon Highway Plan and the Access Management Administrative Rule (OAR 734-051-0115). Therefore, it is recommended that the Independence Development Code be updated to include the following access management standards:

**Table 3-2. Access Management Spacing Standards for Private and Public Approaches on District Highways<sup>(1)(2)(3)(4)</sup> (Measured in Feet)\***

Posted Speed <sup>(5)</sup>	Urban**	STA
55	700	
50	550	
40 & 45	500	
30 & 35	350	(6)
≤25	350	(6)

\* Measurement of the approach road spacing is from center to center on the same side of the roadway.

\*\*These standards also apply to Commercial Centers.

Notes on Tables 3-2:

- (1) These access management spacing standards are for unsignalized approaches only. Signal spacing standards supersede access management spacing standards for approaches.
- (2) These access management spacing standards do not apply to approaches in existence prior to April 1, 2000, except as provided in OAR 734-051-0115(1)(c) and 734-051-0125(1)(c).
- (3) For infill and redevelopment, see OAR 734-051-0135(4).
- (4) For deviations to the designated access management spacing standards see OAR 734-051-0135.
- (5) Posted (or Desirable) Speed: Posted speed can only be adjusted (up or down) after a speed study is conducted and that study determines the correct posted speed to be different than the current posted speed. In cases where actual speeds are suspected to be much higher than posted speeds, the Department reserves the right to adjust the access management spacing accordingly. A determination can be made to go to longer access management spacing standards as appropriate for a higher speed. A speed study will need to be conducted to determine the correct speed.
- (6) Minimum access management spacing for public road approaches is the existing city block spacing or the city block spacing as identified in the local comprehensive plan. Public road connections are preferred over private driveways and in STAs driveways are discouraged. However, where driveways are allowed and where land use patterns permit, the minimum access management spacing for driveways is 175 feet (55 meters) or mid-block if the current city block spacing is less than 350 feet (110 meters).

### **Traffic Management Recommendations**

This section presents a discussion of various strategies that can be implemented to clarify, improve and preserve traffic operations within the Independence UGB. Included in this discussion are the development of roadway intersection performance standards, and the preparation of traffic impact studies to assess the impacts associated with specific development applications and to define appropriate mitigation strategies and responsibilities.

### **Performance Standards**

The TPR [660-12-045(2)(b)] requires local governments to adopt standards to protect future operation of roads, transit ways and major transit corridors. The OHP similarly calls for the creation of performance standards to protect the mobility of state owned transportation facilities. These performance standards apply to TSP projects and amendments to TSPs, comprehensive plans and development codes.

### **State Highways**

The 1998 Independence TSP applied a level of service threshold of LOS D to major arterials, including Oregon 51. This standard for Oregon 51 is inconsistent with the performance

standards as found in the 1999 Oregon Highway Plan (OHP). ODOT currently uses V/C ratios to measure state highway performance rather than intersection or roadway LOS. The peak hour, maximum V/C standards that will be applied to various portions of Oregon 51 are summarized in Table 3-3.

**Table 3-3. Oregon 51 (Hwys 193 & 43) Peak Hour, Maximum V/C Standards**

District Highway, Inside UGB, Non-MPO Designations	Maximum V/C Ratio
STA	0.95
Posted speed <=35 mph or UBA	0.90
Posted speed >35 mph	0.85
Posted speed >=45 mph	0.80

Source: Oregon Highway Plan, Policy 1F Mobility Standards, Table 6.

### City Streets

The 1998 Independence TSP applied an intersection level of service threshold of LOS B or better to guide municipal roadway design of minor arterials, collectors and local streets. Using LOS standards for municipal roadways is problematic for two reasons:

- Using an LOS standard is not consistent with the V/C measure used by ODOT for state highway facilities (e.g., Oregon 51 in Independence). If the City of Independence used an LOS standard for their municipal roadways, some confusion could result between the use of the two standards.
- The V/C standard can at some times identify potential problems with intersection operations even when the level of service (as measured in terms of delay per average vehicle) is considered to be acceptable.

Therefore, it is recommended that the City of Independence adopt performance standards for all municipal roadways inside the Independence UGB that are measured based on volume-to-capacity (V/C) ratios.

To maintain a relatively low V/C standard (e.g., 0.70 or lower) would likely require construction of more roadway and/or intersection improvements than would be the case if the standard were higher. Correspondingly, implementation of a relatively high standard (e.g., 0.90 or greater) could lead to potential congestion and/or safety problems that might be considered to be inappropriate for a small city such as Independence. Each community must balance factors related to costs and mobility when identifying an appropriate and affordable service level for users.

To preserve infrastructure investments and ensure adequate capacity for new development, the City of Independence establishes a V/C standard of 0.80 as a threshold in determining the need for improvements. This standard would apply to:

- Existing intersections when development related mitigation is required, and
- Creation of new intersections resulting from the development of new streets and/or street connections.

A successful downtown tends to have greater congestion, with intersections with higher V/C ratios. A requirement to maintain .80 V/C standards on City streets in downtown Independence could lead to the installation of turn lanes at downtown intersections. Turn lanes would lead to greater pedestrian crossing distances, therefore making downtown less safe for pedestrians, as well as altering the traditional feel of this historic district. To avoid

these impacts, a V/C standard of .95 will be the established standard for city-owned intersections bounded by B Street to E Street and 2nd Street to Main Street.

The OHP's V/C standards as they pertain to Oregon 51, and the proposed V/C standards for city streets, shall be incorporated into the City's Development Code.

### **Traffic Impact Studies**

The TPR [660-12-045(2)(e)] requires local governments to adopt land use regulations that create a process for applying conditions to development proposals to minimize impacts and protect transportation facilities, corridors, or sites. The Independence Development Code addresses this requirement by providing clear authority to require Traffic Impact Analysis to determine the traffic impact of land use actions and to allow the assignment of conditions of approval on land use actions. However, while the City can require Traffic Impact Analysis, there is no language establishing a threshold for when Traffic Impact Analysis should be prepared. Therefore, it is recommended that the following language be added to the Independence Development Code:

*"Traffic Impact Analysis. The City Manager or designee may require a traffic impact analysis report, prepared by an Oregon professional traffic engineer or an Oregon registered Professional Engineer with expertise in traffic engineering, for any development permit or land use application. A traffic impact analysis report shall be required for all development permits and land use applications which:*

- 1. Generate a net increase of 200 or more vehicle trips per day; or*
- 2. Are likely to increase the V/C ratio or decrease the safety of a State transportation facility.*

*Traffic Impact Analysis Reports shall include:*

- 1. The total estimated vehicular, pedestrian, bicycle and other transit service trips to be generated from the proposed development;*
- 2. The impact of the total estimated vehicular, pedestrian, bicycle and other transit service trips on the existing street, sidewalk, bicycle and other transit systems within the City; and*
- 3. Identification of improvement necessary to mitigate the total impact from the proposed development as identified in item 2."*

### **New Roadway Improvements**

The inventory of existing conditions showed that most roads in Independence are currently operating at acceptable performance levels. However, as traffic volumes increase in the future, congestion will occur. Increasing the capacity of existing street and intersections, and developing alternative routes will be needed. Some approaches to relieving congestion will also be realized by improving intersection operations through traffic control enhancements, and employing access management techniques. Any proposed improvements on the State Highway require approval by ODOT.

Figure 9 illustrates the conceptual roadway improvements. The street network plan is intended to be used as a guide to assure the dedication, or in some cases, the acquisition of adequate rights-of-way for streets and related facility improvements in appropriate locations. While exact alignments may require more detailed refinement studies, this plan identifies the general alignments and connections that need to be made in order for the City to provide a safe, convenient, and economic transportation system with adequate access to all planned land uses.

The centerpiece of improvements is a new minor arterial roadway running parallel to, and to the south of, Monmouth Street (Oregon 51). This new arterial would provide a new travel

route for those living and working in the southern portion of the Independence UGB, and is anticipated to draw through traffic currently using Oregon 51 to travel from South Salem to the City of Monmouth.

To be an effective alternate route to Monmouth Street (Oregon 51), the new Arterial Roadway must:

- Be free of on-street parking and driveways
- Have limited intersections (e.g., Corvallis Road, 7th Street, 13th Street, and Talmadge Road/16th Street)
- Maintain travel speeds with minimal delay at intersections (no signals are anticipated at the intersections with 7th or 13th Streets and roundabouts are recommended)
- Continue west and connect with OR 99W in the City of Monmouth

The design and alignment of the roadway will be the subject of a future refinement plan. However, for planning purposes, the roadway will be classified as a Minor Arterial according to City of Independence standards and will be located somewhere north of Stapleton Road. The Minor Arterial standard includes two 12 foot travel lanes, bike lanes and sidewalks, with a posted speed of 35 mph or higher. It is also important that the new Minor Arterial roadway be designed consistent with State Highway standards, in case the City of Independence and Oregon Transportation Commission agree to a jurisdictional transfer between the existing Oregon 51 (Monmouth Street) and this new Minor Arterial (which could serve as a bypass to Oregon 51).

Another significant project is a new directional circulator that will divert southbound to westbound Oregon 51 traffic away from the Main and Monmouth Street Intersection. The diverted traffic would travel westbound down "C" street, an existing one-way street, then turn southbound, somewhere between 2nd Street and 5th Street, to reconnect with Oregon 51 (Monmouth Street) west of the intersection with Main Street. Without this diverter, new turn lanes would be needed at the Main and Monmouth Street Intersection, which would result in the removal of the existing curb extensions and potential right-of-way acquisition.

#### **Capacity Improvements to Existing Roadways**

To accommodate future trip growth, new turn lanes will be added at the intersections of Hoffman Road and Gun Club Road and Polk Street and Main Street. These turning lane locations are discussed further on Table 3-4. In addition, G Street is a designated collector street, providing an alternative route for local traffic seeking to avoid portions of Monmouth Street (Oregon 51). G Street's east/west stop signs will be replaced with north/south stop signs, to increase the usefulness of this road as a local traffic alternative route.

#### **Safety Improvements**

The existing conditions analysis identified locations where safety enhancements or improvements are needed. These include improving rail crossings and both street pavement and trackage along 2<sup>nd</sup> Street, filling gaps in the bicycle and pedestrian network, and minimizing conflicts between traffic and pedestrians crossing Oregon 51 near Central High School over the lunch hour.

Projects to address 2nd Street issues and gaps in the bicycle and pedestrian network are included in Table 3-4 and Figures 7, 8, and 9 in this report. Regarding the school issue, the following structural solutions to this safety and congestion problem were considered and rejected:

- Pedestrian overcrossing: rejected based on likelihood that many students would still cross at street level and the significant cost of an overcrossing.

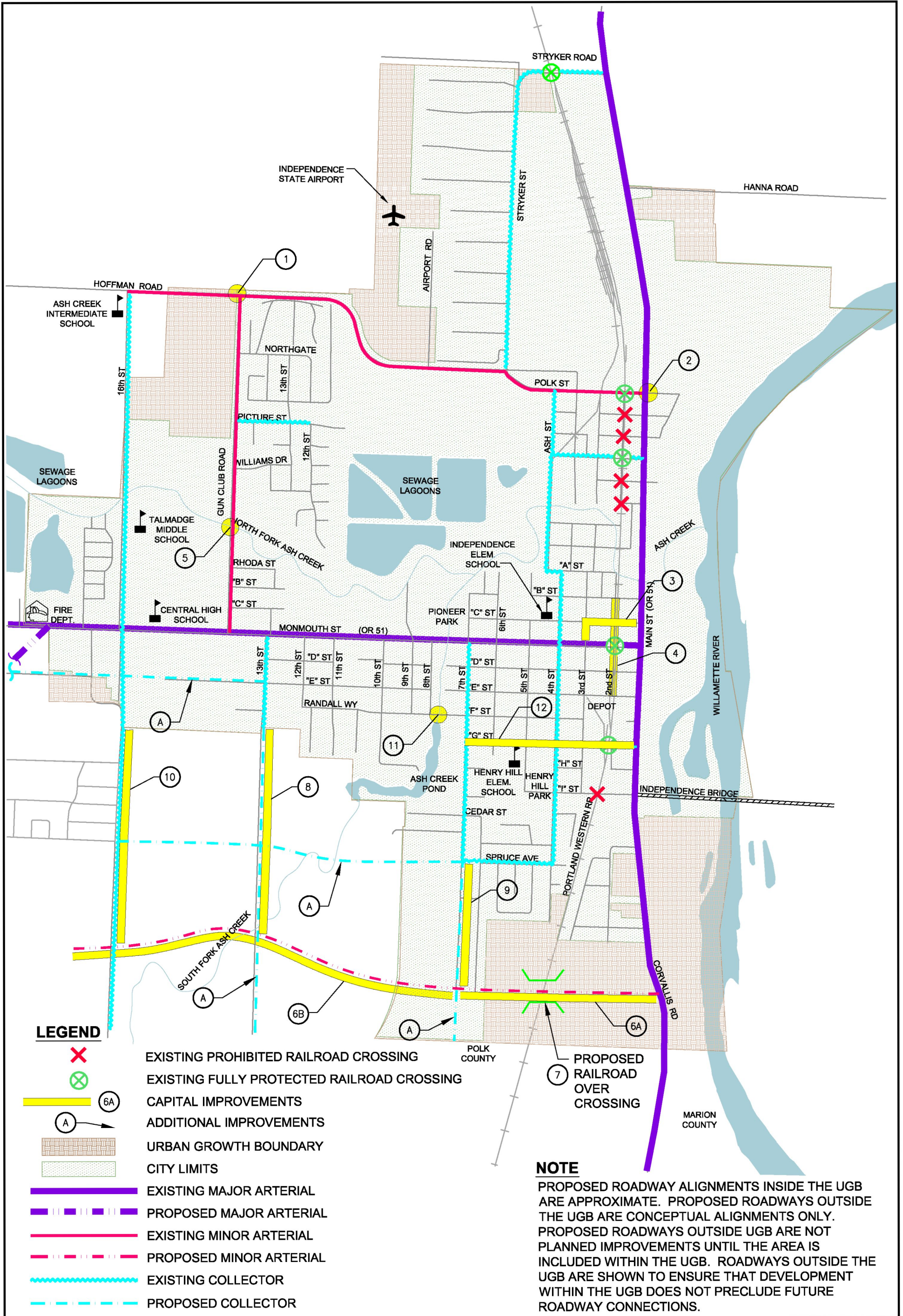

**Figure 9**  
**Capital Improvement Projects**

**This page intentionally left blank.**

- Fencing on school property to prevent mid-block crossings: rejected based on the need to keep school fire lanes open and because it fails to address the primary problems – number of students crossing at or near approved crossings and failure by some to obey traffic signals.
- Additional pedestrian crossing: rejected because it fails to address one of the primary problems – number of students crossing at or near approved crossings and failure by some to obey traffic signals. Also rejected based on the close proximity of existing fully signalized intersection at 16th and Monmouth Street and Pedestrian crossing between 16th Street and Gun Club Road on Monmouth Street.

The Central School District 13J will address highway safety and congestion problems caused by significant numbers of Central High School students crossing Monmouth Street during the lunch break, including some students who fail to use approved crossings and/or obey traffic signals. To alleviate these problems, the Central School District 13J is considering a phased plan to close Central High School's campus at lunch and/or the use of crossing guards. The City of Independence supports the school district's efforts to address safety issues, and this TSP does not contemplate capital improvements at this time.

#### **Other Roadway System Policies**

Polk County maintains the County road system, which exists largely outside of urban areas, to a rural standard. Traditionally, as city limits expand to encompass County road segments, ownership of these road segments are transferred to the city, so the roads may be maintained to urban standards. The following policy will help ensure County road segments are transferred to the City of Independence as city limits are expanded:

- The city will simultaneously annex land and the county roads found within, or bordering, the newly annexed land.

The following additional policies, excerpted from the 1998 TSP, are incorporated below:

- The city will manage the supply, operations, and demand for parking in the public right-of-way to encourage the economic vitality, traffic safety, and livability.
- The city will consider the use of traffic management devices (signs, signals, curb extensions, and markings), consistent with sound engineering and planning practices, to improve safety and livability in neighborhoods and in the commercial district.

#### **Beyond the 20-year TSP Planning Horizon**

Additional road improvements are anticipated to be needed when full build-out of the Independence UGB occurs, predicted to occur in approximately 2042. These improvements, as detailed in Table 3-5, include new turn lanes at Monmouth Street and 7th Street and Main Street and G Street, plus new signals at the Main Street and Polk Street and Monmouth Street and Main Street intersections. In addition, roundabouts will need to be added to intersections on the new east-west arterial, to ensure enough traffic capacity.

### **3.3 PUBLIC TRANSIT ELEMENT**

This section documents an assessment of needs, deficiencies, policies and improvements affecting the public transit system within the Independence Urban Growth Boundary (UGB). Included is a discussion of public transit policy guidance, an evaluation of needs and deficiencies, and a summary of specific policy changes.

## Public Transit Policies

The Polk County TSP inventoried the existing public transit system and evaluated the public transit needs for the entire county. The TSP concluded that due to the small size of the urban centers, excepting West Salem, public transit planning and implementation should be a coordinated, regional process, particularly with respect to the fixed-route bus service or commuter services.

The TPR requires (OAR 660-12-020) requires that the TSP include a Public Transit Plan which:

1. Describes public transit services for the transportation disadvantaged and identifies service inadequacies.
2. Describes inter-city bus and passenger rail service and identifies the location of terminals.

For urban areas where the area is already served by a public transit system, the TPR [660-12-045(4)] requires support of transit by requiring a variety of land use regulations. Given the population and location of the City of Independence, as well as the limited nature of transit currently serving the City of Independence, it was determined that only select sections of TPR [660-12-045(4)] should apply [(a), (b) & (e)]. These include the requirements that:

- Transit routes and facilities shall be supported through appropriate measures such as bus stops, pullouts, optimum road geometrics, or parking restrictions;
- New retail, office and institutional developments should include transit routes and facilities and convenient pedestrian access to transit through walkways and connections; and
- Allow existing developments to redevelop portions of parking areas for transit oriented uses where appropriate.

The following policy for public transit was included in the existing City of Independence TSP (1998) and is incorporated herein:

- The City shall coordinate with governmental and private agencies in the planning and provision of public transportation services and shall ensure that a given level of service is adequate for the costs incurred.

The following policy for public transit was included in the existing City of Independence TSP (1998):

- The City will coordinate with other jurisdictions when the need for park-and-ride facilities is studied.

This policy is replaced by the following policy:

- The City will coordinate with willing private property owners to establish park-and-ride facilities for public transit and carpool users.

## Public Transit Improvements

Existing public transit services and needs are described in Chapter 2.3 of this TSP. OHAS, the operator of CARTS, is currently developing alternatives for enhancing transit services in Polk and Marion Counties. The City of Independence will review the alternatives that will be proposed by OHAS, Inc., and work with this agency and other local governments to improve public transit options within the UGB. In particular, the City of Independence will encourage an expansion of peak-period commuter service to the Salem area, and look for park-and-ride lot locations to support this commuter service. Potential park-and-ride locations include the parking lots for the:



- Central Plaza;
- Riverview Park;
- Cornerstone Christian Center;
- Independence Cinema 8; and
- First Baptist Church.

The City of Independence will also develop the following land use requirements, when the population or available transit service warrants:

- Transit routes and facilities shall be supported through appropriate measures such as bus stops, pullouts, optimum road geometrics, or parking restrictions; and
- New retail, office and institutional developments should include transit routes and facilities and convenient pedestrian access to transit through walkways and connections.

The following provision be incorporated into the City of Independence Development Code to support the use of transit service within the community:

- Allow existing developments to redevelop portions of parking areas for transit oriented uses where appropriate

As population increases or modal trends allow, the City of Independence will encourage private long-haul bus, passenger rail, and taxi service operations within the Independence UGB.

### 3.4 BIKEWAY SYSTEM ELEMENT

This section documents an assessment of needs, deficiencies, policies and improvements affecting the bicycle transportation system within the Independence Urban Growth Boundary (UGB). Included is a discussion of policy guidance for the bicycle circulation system, an evaluation of needs and deficiencies, and a summary of specific improvements.

#### **Bicycle Transportation System Policies**

The TPR requires (OAR 660-12-020) requires development of a bicycle and pedestrian plan for a network of bicycle and pedestrian routes throughout the planning area as a part of the TSP.

The TPR also requires that, when developing the bicycle and pedestrian circulation plans, local governments shall identify improvements to facilitate bicycle and pedestrian trips to meet local travel needs in developed areas. Appropriate improvements will provide for more direct, convenient and safer bicycle or pedestrian travel within and between residential areas and neighborhood activity centers (i.e., schools, shopping, transit stops). Specific measures include, for example, constructing walkways between cul-de-sacs and adjacent roads, providing walkways between buildings, and providing direct access between adjacent uses.

The TSP's bikeway system element is described in detail in the Independence-Monmouth Comprehensive Master Bicycle Plan (1991). Network and facility improvements are described in the Master Bicycle Plan. The TSP amends the Plan to add bikeways to the entire collector street network. The bikeway facilities requirements for the entire street network are found in the street design standards (Table 3-1).

The following three goals are taken from the Master Bicycle Plan. The TSP incorporates these goals, and the thirteen objectives associated with the goals, by reference.

- Goal. To provide and maintain a safe, convenient, and pleasing citywide bicycle system that is integrated with other transportation systems.
- Goal. To encourage and support bicycle safety, education, and enforcement programs.
- Goal. To develop a comprehensive system of through routes, a perimeter beltline loop, secondary connecting routes, and recreational routes.

As a matter of policy, it is recommended that when traffic volumes on collector streets exceed 2,000 ADT, the City shall consider the removal of on-street parking and the addition of bicycle lanes.

### **Bicycle Transportation System Recommendations**

The Bicycle Element has received only slight updates since adoption of the 1998 City of Independence TSP. The City of Independence is contemplating updating the Independence-Monmouth Comprehensive Master Bicycle Plan (1991) in the next few years to reflect changes that have occurred in the community over the past decade. For purposes of the TSP, priority bicycle facility improvements have been identified below. It is important to note that the costs are planning level estimates only.

#### **New Facilities**

New bicycle infrastructure will include bicycle lanes on all new city-owned Arterials and Collector roadways over 2,000 ADT, as required by the TPR. Changes are not proposed for those portions of the state-owned Oregon 51 which currently have parking, lack bicycle lanes and are posted for  $\leq 25$  mph travel (Main and Monmouth Streets near the Downtown Business District). These portions of Oregon 51 have low travel speeds and significant congestion, allowing a shared roadway designation to safely accommodate both bicyclists and vehicles. Priority locations for bicycle lane improvements include (estimated costs in parenthesis):

- Main Street from Polk Street to the Ash Creek Bridge and from “D” Street to the Independence Bridge (\$600);
- The west side of Gun Club Road (\$880k);
- Polk Street from Ash Street to Main Street (Oregon 51) (\$180); and
- Stryker Road from Hoffman Road to Main Street (Oregon 51) (\$800).

Gun Club Road requires widening to accommodate the addition of a bicycle lane and sidewalk, resulting in a project of significant cost. The remaining priority bicycle lane projects are expected to only require new road striping, and therefore have a rough planning level cost estimate of only .15 cents per linear foot.

Priority bicycle improvements also include the proposed Ash Creek Trail, which is expected to cost roughly \$3.25 million and includes the pedestrian element of the trail.

The costs of the priority bicycle infrastructure above, and the priority pedestrian infrastructure below, are included in the “Various Locations – Priority Bicycling and Pedestrian Projects” line item in Table 3-4.

#### **Shared Bicycle Facilities**

This TSP amends the master Bicycle Plan to add shared roadway bikeways to all existing and planned collector streets which currently lack bicycle lanes, including the following:

- 4th Street between Spruce Avenue and Polk Street;
- Ash Street (including the west end of “A” Street) between “A” and Polk Street;

- Williams Street between Ash Street and Main Street;
- Talmadge Road between Monmouth Street and the southern UGB;
- 13th Street between Monmouth Street and southern UGB;
- 7th Street between Monmouth Street and southern UGB;
- ‘G’ Street between 7th Street and Main Street;
- Picture Street between Gun Club Road and east end; and
- Stryker Road between Hoffman Road and Main Street.

### 3.5 PEDESTRIAN SYSTEM ELEMENT

This section documents an assessment of needs, deficiencies, policies and improvements affecting the pedestrian transportation system within the Independence Urban Growth Boundary (UGB). Included is a discussion of policy guidance for the pedestrian circulation system, an evaluation of needs and deficiencies, and a summary of specific improvements.

#### **Pedestrian Transportation System Policies**

The following policies for the pedestrian transportation system in the Independence UGB have been excerpted from the 1998 TSP and are incorporated below. Pedestrian system planning requirements under the TPR have been identified and discussed in the Bikeway System Element:

- Low curb crosswalks shall be built as a part of all intersection projects, consistent with ADA guidelines, to facilitate use by the transportation disadvantaged, the elderly, and people with disabilities.
- The City shall remove physical obstruction of sidewalks such as utility poles, sign posts or guy wires, to ensure 4’ of passable sidewalk (consistent with ADA guidelines).
- Visibility and unobstructed views shall be promoted for all areas of high pedestrian use.
- Bicycle traffic on sidewalks shall be prohibited.

#### **Pedestrian Transportation System Recommendations**

The Pedestrian Element has received only slight updates since the 1998 City of Independence TSP.

The street design standards (Table 3-1) include sidewalk standards. These standards apply to new construction and reconstruction. The City shall give consideration to the arterials, collector streets, and school routes lacking sidewalks when prioritizing and planning for road improvement and maintenance projects. Priority locations for sidewalk improvements include the:

- West side of Gun Club Road;
- East side of Ash Street (including the west end of A Street);
- North side of Williams Street between Log Cabin Street and Main Street;
- Both sides of “G” Street between 4th Street and 3rd Street;
- West Side of 5th Street between Henry Hill Elementary and “I” Street;
- South side of “I” Street between 5th Street and 4th Street;
- East side of 4th Street between “I” Street and Maple Drive;

- South side of Polk Street between rail tracks and Walnut Street; and
- Two northerly segments and one western segment of Stryker Road.

Priority pedestrian improvements also include the proposed Ash Creek Trail.

The costs for improvements to Gun Club Road and the creation of the Ash Creek Trail were discussed in the Bikeway System Element. The remaining priority pedestrian projects are expected to cost \$540 per linear foot, for a total cost of approximately \$2.94 million. This rough planning level cost estimate includes curbs, gutters, six foot sidewalks, landscaping, and storm drains. This estimate assumes that road widening to accommodate the sidewalks will not be needed, and that a stormwater conveyance system to tie into already exists. The estimated costs of these improvements are included in the “Various Locations – Priority Bicycling Projects” line item in Table 3-4.

Improving connectivity and circulation patterns of pedestrian facilities will be considered in new development and in improvements to the existing system, where possible. Examples of ways to improve connectivity and circulation include constructing walkways between cul-de-sacs and adjacent roads, providing walkways between buildings, providing walkways to parks and school sites, and constructing curb ramps.

### **3.6 AIR, TRUCK FREIGHT, RAIL, WATER AND PIPELINE TRANSPORTATION ELEMENTS**

The TPR requires that TSPs include elements related to air, freight, rail, water and pipeline transportation systems. Collectively, these elements should identify where public use airports, mainline and branch line railroads and railroad facilities, port facilities, and major regional pipelines and terminals are located or planned within the Independence UGB. Additionally, for airports, the planning area shall include all areas within the airport’s imaginary surfaces and other areas covered by state and federal regulations. Each of these modes is discussed in the paragraphs below. In most cases, text has been excerpted from the 1998 Transportation System Plan as the relevant modal plans have not been updated and the issues identified in 1998 remain current.

#### **Air Transportation**

##### **Policies**

The following policies for air transportation were excerpted from the City’s 1998 TSP:

- The City shall protect and maintain the Independence Airport site and coordinate with Polk County and the Oregon Department of Aviation in protection and maintenance efforts.
- The City, in cooperation with Polk County, shall maintain an airport overlay zoning which coincides with the future approach surfaces and FAR Part 77 surfaces. Airport overlay zoning should conform with Oregon Department of Aviation guidelines.
- City supports designating Runway 34 as the calm wind runway in order to minimize noise exposure on nearby residential areas south of the airport. The City also supports a review of airport operating procedures to ensure that appropriate noise abatement procedures and standard traffic pattern elevations and locations are being utilized at the airport.

## **Rail Transportation**

### **Policies**

Independence will utilize the following policies to minimize conflicts, improve safety, and protect the railroad transportation mode:

- Improve safety by continuing to work with the W&P Railroad and the Rail Division of ODOT to identify crossing closures and safety improvements to existing crossings.
- Improve the trackage on 2nd Street to decrease pedestrian tripping and bicycling hazards, and vehicular and rail conflicts, between “B” and “E” Streets. Since its inception in 1993, W&P has encouraged Independence to consider a median strip on 2nd Street to separate train and vehicular traffic such as was done on 6th Street in Corvallis. The City will keep all design solutions to the existing railroad subgrade failure along 2nd Street open for discussion.
- Work with the railroad to identify, and evaluate the financial feasibility of, alternatives that would improve public safety, reduce roadway wear and tear, and reduce conflicts. For instance, a track alignment that ran down the eastern edge of the City adjacent to the Willamette River would reduce the number of at-grade crossings and improve access and emergency response capabilities. A small roadway underpass located on the south end of the City might also permit passage of emergency response vehicles.
- Reduce environmental degradation (noise impacts) and conflicts by requiring residential development adjacent to the railroad to use sound mitigation structures or planting buffers.
- Promote safe and efficient operation of the railroad and road system by allowing no new at-grade crossings by local roads and minimize the number of arterial and collector street at-grade crossings.
- Identify and evaluate the economic feasibility of various alternatives to provide for emergency access and response capabilities to the entire City. Some alternatives include building an overpass at an existing at-grade crossing or an unbuilt collector or arterial crossing, constructing an underpass near the existing trestle near Ash Street, or providing a satellite emergency response capability for the east side of Independence.

## **Truck Freight**

Trucks bring freight to and through the City of Independence. The roadway from the intersection of Oregon 51 (Main Street) and Polk Street, west along Polk Street and Hoffman Road, to the intersection of Hoffman Road and Oregon 99W in Monmouth, currently operates as the major truck route. This operation is enforced through passive measures; curb extensions in place at the intersection of Main Street and Monmouth Street make truck turning movements difficult, providing a disincentive for trucks to remain on Oregon 51 when traveling through Independence.

## **Pipeline and Water Transportation**

Independence has no major regional pipeline facilities within the UGB. Monmouth has water and sewer mains that traverse Independence. Independence will cooperate with Monmouth regarding their sewer and water line needs.

Independence is located on the Willamette River, which has functioned as transportation facility in the past. Currently, no freight shipping or passenger service occurs on the river, and a limited amount of recreational use of the river occurs. Independence is presently investigating the possibility of recreational use of the river oriented towards water transportation. Independence will continue to investigate the feasibility of river transportation and promote recreational use of the river.

### 3.7 TRANSPORTATION SYSTEM DEMAND AND MANAGEMENT ELEMENT

Due to its size (<25,000 people) and location (not part of a Metropolitan Planning Organization area), Independence is not required to include a Transportation System Demand and Management Element in this TSP. Independence is supportive of public transportation services and facilities (rideshare facilities and regional demand management programs) that would reduce commuter traffic and promote carpooling programs at large employers.

### 3.8 SUMMARY OF RECOMMENDED IMPROVEMENTS

Table 3-4 summarizes the transportation system improvement recommendations as discussed in the preceding sections. Information in the table includes the project location, a short project description, a listing of who has responsibility for implementing the project, an identified funding source(s), and a planning level cost estimate.

For planning purposes, these projects have been divided into short-term (0-10 year implementation, highlighted in Gray) and long term (11-20 year) priorities. However, the need for, and funding of, many of these projects is tied to the timing of future development. While assumptions about development likely to occur by 2026 and 2042 have been made, an analysis of the timing of the development of individual properties at various locations throughout the City was outside the scope of this TSP update. Therefore, the relative priority of the projects is a rough guide only.

The new East-West Arterial project and associated collector street improvements (projects numbered 6, 8, 9, 10) were determined to be short-term priorities due to the positive impact they have on the rest of the transportation system. One-half of the bicycling and pedestrian projects (project 13) were listed as short-term priorities given the positive impact that filling gaps in the bicycle lane and sidewalk will have on bicyclist and pedestrian safety. Replacing east/west facing stop signs with north/south facing stop signs on “G” Street were prioritized given the low cost of the project and the immediate need.

The improvement recommendations for 2006-2026 are illustrated in Figure 9. Also depicted on Figure 9 is a proposed realignment of a short portion of Monmouth Street (Oregon 51) located within the Monmouth UGB. This realignment of Monmouth Street is advisory only, and was included in the 1998 Independence TSP.

**Table 3-4. 2006-2026 Transportation System Capital Improvements**

Map Key	Location	Project Description	Project Partners	Funding Source	Cost Estimate
1	Hoffman Road @ Gun Club Road	Add NB left turn lane	City	100% City	\$21,500
2	Polk Street @ Main Street	Add EB left turn lane	City / ODOT	100% City	\$21,500
3	Monmouth Street @ Main Street	Install directional circulator (Main Street to Monmouth – OR 51) to accommodate SB to WB traffic.	City / ODOT	100% City	\$42,900
4	2nd Street between B and E Streets	Improve street pavement and trackage conditions, including railroad crossing treatments.	City / ODOT / Railroad	60% Railroad / 40% City	\$3,043,200

**Table 3-4. 2006-2026 Transportation System Capital Improvements**

Map Key	Location	Project Description	Project Partners	Funding Source	Cost Estimate
5	Gun Club Road Bridge	Replace existing bridge	City	100% City	\$806,200
6	New East/West Arterial Road from Corvallis Road to OR 99W	Build new 2-lane arterial road with bike lanes, sidewalks and limited access. Left turns at major intersections:  Phase A: Corvallis to 7th  Phase B: 7th to Talmadge	City / ODOT / Railroad	50% City / 50% Private	Phase A: \$1,319,300  Phase B: \$2,852,700
7	New East/West Arterial Roadway	Build grade-separated overcrossing at W&P tracks	City / ODOT / Railroad	33% City / 33% Private / 33% Railroad	\$3,674,600
8	New North-South Collector Road between new arterial and Monmouth at 13th Street	Build new 2-lane collector road with bike lanes and sidewalks.	City / County / ODOT	50% City / 50% Private	\$1,668,000
9	New North-South Collector Road between new arterial and Monmouth at 7th Street	Build new 2-lane collector road with bike lanes and sidewalks.	City / ODOT	50% City / 50% Private	\$394,400
10	Talmadge Road between 16th and new arterial	Improve to Collector Road standards	City / County / ODOT	50% City / 50% Private	\$1,947,700
11	F Street Bridge	Replace existing bridge	City	100% City	\$806,200
12	G Street between Main Street and 7th Street	Replace E/W facing stop signs with N/S facing stop signs	City	100% City	\$1,600
13	Various Locations	Priority Bicycling and Pedestrian Projects	City	100% City	\$7,070,000

Note 1: Project costs represent construction and engineering costs only and do not include costs of right-of-way.

Note 2: Projects highlighted in gray are considered short-term (0-10 year) projects, all others are considered long-term projects (11-20 year). One half of Project #13, composed of multiple bicycle and pedestrian projects, is considered to be among the short-term priorities.

Note 3: Estimated project funding sources for rail projects provide by City of Independence.

Note 4: NB means northbound, SB means southbound, EB means eastbound, and WB means westbound.

Table 3-5 summarizes the transportation system improvement recommendations as discussed in the roadway element for the period beyond the TSP's 20-year planning horizon. These improvements would be needed with full build-out of the community, anticipated to occur by 2042. Information in the table includes type or purpose of each project and a short description of the project's elements.

**Table 3-5. Full UGB Build Out (2042) Transportation System Capital Improvements Program\***

Location	Project Description
Monmouth Street @ 7th Street	Add northbound left turn lane.
Main Street @ Polk Street	install signal **
Monmouth Street @ Main Street	install signal **
Main Street @ 'G" Street	Add eastbound left turn lane
Various locations	Install traffic control at new arterial intersections

\*These projects are in addition to the 2026 With Arterial Transportation System Capital Improvements Program.

\*\*Preliminary Signal Warrants were calculated and met, and are included in Appendix Section B-4.

Portions of the proposed system of new streets, street extensions, and other street-related improvements identified on Table 3-4 and 3-5 are currently located outside of the Independence UGB, and are, therefore, only recommendations. These portions of projects outside the Independence UGB are not planned facilities within this TSP. However, these improvements have been referenced in this TSP as they are logical extensions to the planned roadway network. These projects may be constructed by another jurisdiction, or may be constructed by the City of Independence if they are authorized by a subsequent land use decision such as a UGB expansion or a goal exception. Improvements such as the new east/west arterial and its collector street connections offer significant benefits to the City of Monmouth, as well as to ODOT, the current owner/operator on Oregon 51 along Monmouth Street. These road network enhancements will improve traffic flow on Oregon 51 and Oregon 99W, and will require coordination with Polk County, the City of Monmouth, and ODOT in their design and construction.



## **4. IMPLEMENTATION OF TRANSPORTATION SYSTEM PLAN**

### **4.1 REVIEW AND COORDINATION**

This TSP has been reviewed by staff from the City of Independence, Polk County, ODOT and the Department of Land Conservation and Development (DLCD) to ensure consistency with other plans and compliance with the TPR.

### **4.2 IMPLEMENTING ORDINANCES**

The TPR requires cities to adopt policies and land use regulations for implementing the TSP as provided for in OAR 660-12-045. A review of Independence's development code and Comprehensive Plan has been completed and changes and additions made. The existing ordinances, and indicated changes and additions, are shown in Appendix C. The implementing ordinances were reviewed and adopted during review and adoption of the TSP.

### **4.3 FINANCING AND CAPITAL IMPROVEMENT PROGRAM**

The City of Independence had a shortfall in its transportation investment budget prior to adoption of this TSP, one that has grown with the adoption of the TSP identified projects from Table 3-4. Nonetheless, through the TSP's public outreach program, residents have indicated a strong desire for improvements to the transportation system to keep pace with growth and maintain a high quality of life. This TSP presents a detailed assessment of available funding and what it will cost to deal with the shortfall, all in 2006 adjusted dollars. Options are provided for increased funding, but project implementation will entail difficult decisions and significant competition for funds.

The \$23,669,800 (with \$15,290,848 as the estimated City share) in projects identified in Table 3-4 will likely be funded through a combination of City, private, and State funding sources. The City does not currently maintain a capital improvement program, other than tracking and facilitating the projects that will be completed by the private sector and with system development charge (SDC) revenue. While the TSP focuses primarily upon the financing and completion of new capital improvement projects, the City is also charged with the maintenance of existing transportation investments, composed primarily of streets and bridges.

In general, capital and maintenance expenditures are tied to specific revenue types. For example, fees collected for system maintenance cannot be used for capital expenditures without modifying the fee's enabling legislation. State gas tax revenues are able to be used for capital improvements, operations and maintenance, and bond payments. SDCs cannot be used for operations and maintenance, and street utility fees cannot be used for capital improvements.

Fees assessed to fund existing operations and maintenance costs can be enacted, increased and decreased by the City Council without a vote, provided statutory requirements are met for public comment. If statutory requirements are met for public comment and a public hearing is held, the City Council can also increase or decrease fees collected for capital expenditures, such as SDCs, without voter approval. Table 4-1 presents a summary of anticipated revenues and baseline costs related to the Independence transportation system over the 20-year planning period. For budget estimating purposes, the cost of short-term projects (0-10 year) was divided evenly between years 1-5 and years 6-10, and the cost of long-term priority projects was divided evenly over years 11-15 and years 16-20.

**Table 4-1. Summary of the City of Independence Transportation System Needs and Revenues\***

	<b>Years 1-5 2006-2011</b>	<b>Years 6-10 2011-2016</b>	<b>Years 11-15 2016-2021</b>	<b>Years 16-20 2021-2026</b>	<b>Total 2006-2026</b>
<b>Revenue Estimates (Ex. Sources)</b>					
Gas Tax	\$2,200,121	\$2,661,944	\$2,939,001	\$3,244,895	\$11,045,961
Transportation SDCs	\$1,256,920	\$1,256,920	\$1,256,920	\$1,256,920	\$5,027,680
Interest	\$25,000	\$25,000	\$25,000	\$25,000	\$100,000
Cash carried forward from prior year	<u>\$101,365</u>	<u>\$0</u>	<u>\$0</u>	<u>\$0</u>	<u>\$101,365</u>
<b>Total</b>	<b>\$3,583,406</b>	<b>\$3,943,864</b>	<b>\$4,220,921</b>	<b>\$4,526,815</b>	<b>\$16,275,006</b>
<b>Cost Estimates</b>					
Maintenance & Operations	\$2,608,294	\$3,105,807	\$3,415,934	\$3,771,467	\$12,901,502
Cash Reserves (year end)	\$0	\$0	\$0	\$0	\$0
Debt Service	\$1,157,915	\$0	\$0	\$0	\$1,157,915
Capital Outlay	<u>\$3,535,800</u>	<u>\$3,535,800</u>	<u>\$4,109,624</u>	<u>\$4,109,624</u>	<u>\$15,290,848</u>
<b>Total</b>	<b>\$7,302,009</b>	<b>\$6,641,607</b>	<b>\$7,525,558</b>	<b>\$7,881,091</b>	<b>\$29,350,265</b>
<b>Shortfall</b>	<b>(\$3,718,603)</b>	<b>(\$2,697,743)</b>	<b>(\$3,304,637)</b>	<b>(\$3,354,276)</b>	<b>(\$13,075,259)</b>

\*Revenue estimates and all cost estimates other than Capital Outlay's provided by City of Independence staff

The following portion of the TSP describes methods that the City may use, and in some cases does use, to fund proposed projects. These finance methods may be used individually or in combination to fund projects, or to contribute the City's share of joint agency transportation projects. Funding methods are categorized as follows:

- Available Funding Methods. These funding sources are either currently in use in the City of Independence or could be administered without a change in Independence municipal code.
- Potential Funding Methods. These funding sources are not in use in the City of Independence and would require either City Council action or a vote of the people to initiate.

### Available Funding Methods

Existing available funding for local transportation safety or capacity improvements primarily comes from four sources:

- Federal/State Funds (funds and loans distributed through ODOT);
- City of Independence; (through fee assessments or approved bond measures);

- Private property owners and developers (through special assessment districts or advanced financing arrangements); and
- The railroad.

Large complex capital improvements such as the proposed new east/west arterial road often involve some combination of these four funding sources to leverage federal/state funding with local match requirements. A brief description of existing state/federal and local funding sources is provided below.

### **State and Federal Funding**

#### ***Federal Surface Transportation Program/State Highway Funding***

As the recipient and distributor of Federal Highway Administration funding, the Oregon Department of Transportation (ODOT) is the primary distributor of federal and state transportation funding. ODOT allocates funding through updates to the Statewide Transportation Improvement Program (STIP).

Independence is included within Region 2 of the ODOT STIP. Projects selected for inclusion in the STIP must be consistent with the goals and objectives of the Oregon Transportation Plan, and its modal plans for highways, public transportation, freight and passenger rail, and bicycle and pedestrian facilities. Eligible projects are usually selected from a list of prioritized improvements included in the Independence Transportation System Plan (TSP) and other related refinement plans or studies. Input and testimony from the general public, the local Area Commission on Transportation, and local government representatives play an important role in getting specific projects on the STIP.

The current 2006-2009 STIP includes assumptions for ongoing federal funding that is authorized by the Safe, Accountable, Flexible, Efficient, Transportation Efficiency Act: A Legacy for Users (known as SAFETEA-LU) which was authorized by the U.S. Congress in and signed into law by President Bush in August 2005.

ODOT has assumed that existing federal and state transportation funds will remain relatively constant over the 2005-2015 time period. However, ODOT assumes project costs will be subject to escalation to reflect rising land/right-of-way (ROW) costs, labor rates, and material costs (such as oil and steel). The combined result of fixed federal/state funding allocations and annual project cost escalation means fewer improvements can be implemented over time.

It should be noted that the state has begun to require contributions from local jurisdictions for some projects when development has significant traffic impacts. An example of this are improvements on U.S. Highway 101 near Lincoln City, and Highway 18 near Valley Junction. Cost sharing may become more common if federal funds decrease in the future. It is expected that local contribution to or cost sharing for projects such as interchanges and bridges will continue.

#### ***Community Development Block Grants***

The Federal Department of Housing and Urban Development administers the Community Development Block Grant Program (CDBG). Funds are allocated based on city size and demographics such as income levels and housing standards. In some areas, street reconstruction projects in older neighborhoods have been funded by this program. Many other cities use these funds to provide or improve the sidewalk system in older neighborhoods, particularly in the vicinity of schools.

### ***State Motor Vehicle Fund***

The State of Oregon collects gas taxes, vehicle registration fees, overweight/overheight fines and weight/mile taxes and distributes a portion of these revenues to counties and cities using an allocation formula. The State distributes a local share to cities based on a per capita rate. Revenues vary from year to year as the allocation formula can vary. Funds can be used for capital improvements or maintenance.

### ***Special Public Works Funds (SPWF Lottery Program)***

The Special Public Works Fund provides grants and loans for public works that support private projects resulting in creation or retention of permanent jobs. Loans are emphasized in this program and are available for amounts up to \$11,000,000 for a maximum of 25 years unless the project life is shorter. The maximum grant amount is \$500,000 and may not exceed 85 percent of the project cost. Loans are typically available at below market rates.

### ***Oregon Transportation Infrastructure Bank***

The OTIB is a statewide revolving fund available to local governments to provide long-term (up to 30-years) low interest loans designed to promote innovative transportation funding solutions. Project must be Federal-Aid eligible (this may require re-designation of access road to achieve appropriate status). Eligible costs include engineering, environmental permitting, right-of-way, construction and project management. Applications are accepted on an on-going basis.

### ***Oregon Immediate Opportunity Fund***

The Immediate Opportunity Fund program, managed by ODOT and the Oregon Department of Economic and Community Development (OECD), provides a maximum of \$500,000 for public road work associated with an economic development related project of regional significance, provided the project creates primary employment. Additionally, although lesser shares will be considered, the grantee should provide an equal local match.

### ***Bicycle and Pedestrian Grant Program***

Grant funds for highways, county roads and local streets where improvements are needed for bicycle and pedestrians and/or bicyclists. Eligible project types include: ADA upgrades; completing short sections of missing sidewalks or bike lanes; street crossing improvements; intersection improvements; and minor widening for bike lanes or shoulders. Grant awards up to \$200,000 based on past trends. Applications are taken periodically.

## **Local Funding**

### ***System Development Charges***

This method collects an equitable share from new developments to help pay for the capital costs of improvements needed to support growth. Cities that use this System Development Charge (SDC) method are required (ORS 223.297) to complete a plan that lists the capital improvements that can be funded by SDCs and the estimated timing and cost for each improvement. SDCs are limited to those capital improvements that will be or were required to increase capacity because of increased demand due to current or expected development. This method is commonly acceptable to the public because new residents, rather than current residents, pay for the improvements. The method is less acceptable to developers because it is argued that it makes new development unaffordable. Revenues provided by this method are variable because they are linked to the amount of new development. The City of Independence currently has an SDC in place, which raised \$252,139 in funds during the 2005-2006 fiscal year.

### ***Full/Partial Private Contributions***

Under this method the developer builds the road to City standards and then deeds the road to the City as a condition of development.

## **Potential Funding Methods**

### **City Gas Tax**

The City could levy a per gallon tax on fuel sold in Independence. Typical taxes range from \$0.01 to 0.03 per gallon and Woodburn, Tillamook, and The Dalles are examples of a communities with such a tax. The City could contract with the State Fuel Tax Branch to collect and administer the tax.

### **Local Vehicle Registration Fee**

This would operate similarly to the existing statewide system. Although the method has been discussed, no City or county governments have implemented such a program.

### **Local Property Tax Levies/Street Bonds**

This method is typically used to fund road improvements that will benefit an entire community. General obligation bonds are supported by a property tax levy on assessed value of property. This method requires voter approval of bond issues and is not usually a viable of funding for single projects that cost less than \$2,000,000.

### **Local Improvement Districts**

This method assesses property owners in an area where capital improvements, such as road and utility projects, are required. Local Improvement Districts (LIDs) have typically been applied in new or developing industrial areas, but could also be used to fund improvements in developed areas through increases in property taxes or other assessments. LIDs can be initiated by property owners or the City, and the collected funds are commonly used to repay debt on bonds incurred to undertake the infrastructure improvements. These bonds are guaranteed by payments from the affected properties through a property lien that sunsets when the LID share is paid off. LIDs typically require at least 51 percent of the affected properties to approve the LID. Costs can be determined based on road frontage or square footage. LIDs are most suitable for individual local street improvement projects.

### **Reimbursement District or Zone of Benefit District**

Public or private entities that build road systems can be compensated by future property owners at a proportional rate, as development occurs. Usually limited to private construction of roads, this mechanism can be useful for public/private developments. Implementation of these districts requires local legislative action.

### **Road User, or Street Utility, Fees**

This method would charge City residents and nonresidential users a monthly or yearly fee for use of the City road system, similar to water and sewer utility fees. User fees go to maintenance activities and have been instituted in a number of communities. The City of Medford's TSP, for example, recommends that the Medford user fee generate over \$100 million over the 20-year life of the plan.

## **Recommended Funding for TSP Improvements**

To implement the TSP, it is estimated that the City will need to raise an additional \$13,075,259 in local revenue and/or grants over the 20-year planning horizon, an annual budget gap of more than \$650,000. This is an ambitious goal, one that can best be achieved by raising the existing SDC fees, creating a road user fee, and vigorously pursuing State and Federal grant sources. Ensuring the TSP identified projects are built also requires vigilance on the part of the City, ensuring that, to the greatest extent allowable by law, private developers (and the railroad, as appropriate) fully participate in project funding.

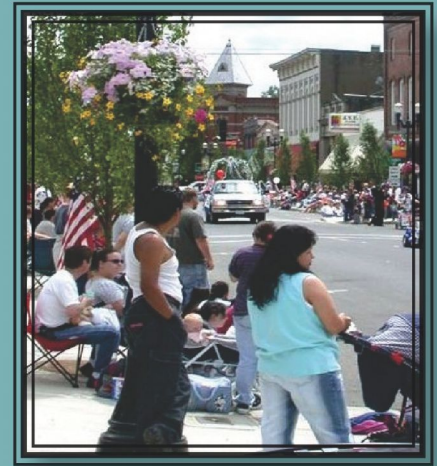
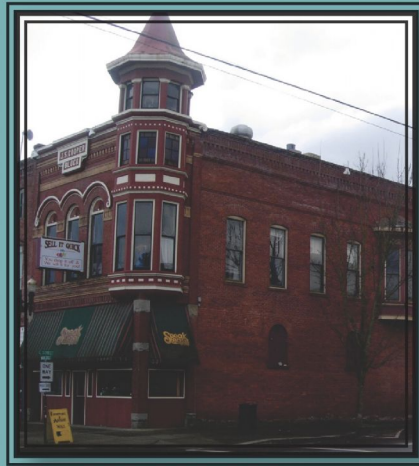

# TECHNICAL APPENDICES



# CITY OF INDEPENDENCE TRANSPORTATION SYSTEM PLAN

Prepared for:

CITY OF INDEPENDENCE  
240 Monmouth Street  
Independence, OR 97351-2424

Prepared by:

**Parametrix**  
700 NE Multnomah Ste. 1000  
Portland, OR 97232-2131

Partially funded by:



JUNE 2007





**APPENDIX A**  
**Existing Transportation System Inventory**



## 1988 TSP Inventory Data, Updated by the City of Independence

**Table A-1 EXISTING STREET CLASSIFICATIONS AND STANDARDS**

Feature	Major Arterial Streets	Minor Arterial Streets	Collector Streets	Local Streets >20 DUs	Local Streets < 20 DUs
Right-of-way width	84 feet <sup>(a)</sup>	66 feet <sup>(a)</sup>	66 feet <sup>(a)</sup>	60 feet	50 feet
Curb-to-curb width	60 feet	36 feet	36 feet	36 feet	28 feet
Moving Lanes	2-4	2	2	2	2
Turn Lanes	<sup>(b)</sup>	<sup>(b)</sup>	<sup>(b)</sup>	0	0
Bike Lanes	2 @ 6'	2 @ 6'	Ph 1: Shared Ph 2: 2 @ 6' <sup>(c)</sup>	Shared	Shared
Parking Lanes	No <sup>(d)</sup>	No	Ph 1: 2 sides Ph 2: No <sup>(c)</sup>	2 sides	1 side
Sidewalks	2 @ 6'	2 @ 6'	2 @ 5'	2 @ 5'	2 @ 5'

a. Additional right-of-way and roadway improvements may be required at major intersections to provide for turn lanes.

b. At all intersections where separate lanes are needed due to volume of turning movement activity.

c. Collectors with < 2,000 ADT can accommodate on-street parking and shared use of road space by bicyclists and motor vehicles. For collectors with > 2,000 ADT the city will study the need to eliminate on-street parking and provide bike lanes.

d. Parking is currently allowed along some sections of the arterial streets in the downtown business district. Existing on-street parking will be allowed to continue until such time as traffic volumes on roadways increase to a level where significant conflicts between moving traffic and parking occur. Parking needs will be evaluated as a part of roadway projects to improve capacity and meet new design standards.

**Table A-2. Existing Street Network: Allocation by Functional Classes**

Functional Class	Linear Feet	Average Width <sup>1</sup>	Percent of Network
Local	87,339	29.1	60
Collector	21,486	23.5	15
Arterial	38,149	34.1	25
<b>TOTAL</b>	<b>146,974</b>	<b>29.6</b>	

Table data is from ODOT inventory information, updated by the City of Independence

<sup>1</sup> This is a "weighted" average for paved roads only and is based on the width of segments of a certain length compared to the entire length.

**Table A-3. Summary of Existing Arterial/Collector Streets**

Street Name	Functional Class	Intersections <sup>1</sup>	Length (ft)	Jurisdiction	Pavement Width (ft)	1993 Condition <sup>2</sup>
"A" St. (Ash to 4th)	Collector	2	142	City	22	100 New
Ash St. (Polk to "A")	Collector	7	2,200	City	36	100 New
13th St. (Monmouth to S UGB)	Collector	4	1,109	City	26-36	100 New pavement
Corvallis Hwy. (southern city limits to southern UGB)	Arterial	2	3,700	County		Fair
Gun Club Rd. (Hoffman to Monmouth)	Arterial	9	4,450	City	24-30	73-97 Fair/Poor
Hoffman Rd. (West UGB to Stryker)	Arterial	3	5,255	City	36	New construction
				County	24	Good
Main St. (Northern UGB to Monmouth)	Arterial	11	7,778	ODOT	32-42	Northern UGB to Polk St. is new
Main St. (Monmouth to southern city limits)	Arterial	6	1,746	City	34 to 52	Good
Monmouth St. (Main to western UGB)	Arterial	19	7,763	ODOT	34-46	Fair to Good
Polk St. (Stryker to Main)	Arterial	5	1,907	City	29-30	100 New pavement
South River Rd. (Main to eastern UGB)	Collector	1	375	City		
Stryker Rd. (Hoffman to Main)	Collector	9	5,395	City	22-29	90
Talmadge (Monmouth to southern city limits)	Collector	1	975	City	36	95
Walnut St. (Polk to Williams)	Collector	4	838	City	36	95

**Table A-3. Summary of Existing Arterial/Collector Streets (Continued)**

Street Name	Functional Class	Intersections <sup>1</sup>	Length (ft)	Jurisdiction	Pavement Width (ft)	1993 Condition <sup>2</sup>
Williams St. (Ash to Walnut)	Arterial	2	275	City	36	95
4th St. ("A" to southern city limits)	Collector	14	2,385	City	30-36	59-95 Fair/Poor
7th St. (Monmouth to UGB)	Collector	12	6,000	City	13-38	59-95

<sup>1</sup> Intersection number includes the crossroads at the ends of the segments evaluated.

<sup>2</sup> Conditions have improved on certain streets since the 1993 inventory due to a street improvement program.

<sup>3</sup> Interpreting the condition rating: 0 - 30 reconstruction, 30 - 80 patching and overlay, and 80 - 100 routine maintenance. Some of these conditions have changed due to the street improvement program of 1995-96 and others.

**Table A-4. Bridges and Culverts**

Structure (Ownership in parentheses)	Location	Construction Date (Dimensions)	Condition
Bridge No. 53B002 (City of Independence)	Ash St. crossing of Ash Creek	1998/1999	Done
Bridge No. 53B001 (City of Independence)	Gun Club Rd. crossing of North Fork of Ash Creek	1983 (32' wide by 56' long)	Sufficiency rating of 81.4. Fair. Needs replacement or widening of ped/bike
Bridge No. 53B003 (City of Independence)	"F" St. crossing of South Fork of Ash Creek.	1968 (32' wide by 61' long)	Sufficiency rating of 67.7. Structurally Deficient. Scheduled for replacement
Bridge / culvert (City of Independence)	13 <sup>th</sup> St. crossing of tributary to the Middle Fork of Ash Creek.		Fair. Needs replacement w/13th improvement
Ash Ck. Bridge (ODOT)	Oregon 51 (Main St.) crossing of Ash Creek.		
South Fork of Ash Ck. Bridge (ODOT)	Oregon 51 (Monmouth St.) crossing of South Fork of Ash Creek.		
South Fork of Ash Ck. Bridge #53C099 (Polk County)	Talmadge Rd. crossing of South Fork of Ash Creek.	1965 (24' wide by 53' long)	70.9
Independence Bridge over Willamette River (#5789A) (Marion County)	"I" St. crossing of Willamette River, "Independence Bridge".	1947 (35' wide by 2,214' long)	Done

**Table A-5. Bike Way Facilities**

Location	Segment Location	Type <sup>1</sup>	Width (feet)	Condition	Ownership/ Jurisdiction
Gun Club Rd.	Picture St. to Monmouth St.	BL: east side SB: west side	4	Good	City
Talmadge Rd.	Monmouth to South UGB	BL: east side SR: west side	5	Good	City
Hoffman Rd.	West UGB to Stryker	SB	5	Good	City
Stryker Rd.	Polk to Main	SB	<4	Good	City
Polk St.	Stryker to Main	SB	<4		City
"I" St.	4 <sup>th</sup> to Main	SB	<4 (partial)		City
Spruce St.	4 <sup>th</sup> to west end	SB	5-6		City
16th St.	Monmouth to north end	SR	<4		City
4th St.	'I' to Spruce	SB	5		City

<sup>1</sup> Type: BL = bike lane, BP = bicycle path, SR = shared roadway, SB = shoulder bikeway

**Table A-6. Arterial or Collector Streets Without Bikeways**

Street Name	Segment
<b>ARTERIALS</b>	
Main Street	No bikeway between Polk St. and south UGB
<b>COLLECTORS</b>	
13th Street	No bikeway between Monmouth and UGB
17th (?) Street	No bikeway between Monmouth and south end
4 <sup>th</sup> Street	No bikeway between "A" and south end
Walnut Street	No bikeway between Polk and Williams
Williams Street	No bikeway between Ash and Main
South River Rd.	No bikeway between Main and the UGB

**Table A-7. Arterial and Collector Streets Without Sidewalks**

Street Name	Segment
<b>ARTERIALS</b>	
Main Street	Stryker (east side) to Hanna Rd
Polk Street	Cabin to Stryker (both sides) = 2,664 feet; Cabin to Marsh (south side) = 300 feet TOTAL: 2,994 feet
Hoffman Road	Airport Rd to UGB (north side)
Gun Club	Hoffman to Monmouth (west side) = 4,450 feet, Picture to Williams (east side) = 652 feet TOTAL: 5,102 feet
<b>COLLECTORS</b>	
Talmadge	Monmouth to UGB (east side)
4th Street	Evergreen to Spruce (east side) = 625 feet
Walnut Street	Williams to Polk (west side) = 1,051, Williams to Picture (east side) = 287 TOTAL: 1,338 feet

## Table A-8. Transportation Facility Data



Street	Section	Existing Functional Class	Future Functional Class	Jurisdiction	Length (ft)	Pavement Width (ft)	Surface	Lane Number	Right* Sidewalk	Left* Sidewalk	Right* Curb	Left* Curb	Right* Bike Facility	Left* Bike Facility	Other/Notes	1993 Rt Sidewalk Condition	1993 Lt Sidewalk Condition	1993 Street Condition	2006 Street Condition	
Mt Fir Ave	Phase 1 East/West	Local	Local		450	36			Y		Y				Additions since 1998, all shared roadway bike use				95	
Rose St	6th to 7th	Local	Local		200	36			Y		Y				Additions since 1998, all shared roadway bike use				95	
Chestnut	6th to just past 7th	Local	Local		350	36			Y		Y				Additions since 1998, all shared roadway bike use				95	
Sweet Cherry Ln	Randall Way to south UGB	Local	Local		550	36			Y		Y				Additions since 1998, all shared roadway bike use				95	
Falcon Lp	West of F St	Local	Local		1200	36			Y		Y				Additions since 1998, all shared roadway bike use				95	
Marigold Dr	Gun Club Rd to cul-de-sac	Local	Local		2150	36			Y		Y				Additions since 1998, all shared roadway bike use				95	
Jasmine Circle	Marigold East/West	Local	Local		700	36			Y		Y				Additions since 1998, all shared roadway bike use				95	
Wisteria St	13th to Northgate Dr	Local	Local		650	36			Y		Y				Additions since 1998, all shared roadway bike use				95	
Hyacinth St	Marigold to Northgate Dr	Local	Local		650	36			Y		Y				Additions since 1998, all shared roadway bike use				95	
Northgate Dr	Gun Club Rd to Hyacinth	Local	Local		800	36			Y		Y				Additions since 1998, all shared roadway bike use				90	
Wild Rose Ct	Northgate Dr to cul-de-sac	Local	Local		350	36			Y		Y				Additions since 1998, all shared roadway bike use				90	
Independence Way	Briar Rd to Convallis Rd	Local	Local		1050	36			Y		Y				Additions since 1998, all shared roadway bike use				95	
Mooney St	Stryker Rd to cul-de-sac	Local	Local		600	36			Y		Y				Additions since 1998, all shared roadway bike use				90	
Luscumbe St	Stryker Rd to cul-de-sac	Local	Local		600	36			Y		Y				Additions since 1998, all shared roadway bike use				90	
Aerona St	Stryker Rd to cul-de-sac	Local	Local		600	36			Y		Y				Additions since 1998, all shared roadway bike use				90	
Conair Dr	Stryker Rd to cul-de-sac	Local	Local		1000	36			Y		Y				Additions since 1998, all shared roadway bike use				95	
Kbel Yeliniemi Ln	Stryker Rd to cul-de-sac	Local	Local		150	36			Y		Y				Additions since 1998, all shared roadway bike use				100	
Taylor Pl	Randall Way to cul-de-sac	Local	Local		550	36			Y		Y				Additions since 1998, all shared roadway bike use				95	
Independence Hwy 51	Stryker to Hanna	Arterial	Arterial	ODOT	1600	32	AC	3	Y		N		Y	Y	L&R bikelines	100	100	New		
Independence Hwy ?	Hanna to Polk	Arterial	Arterial	ODOT	2798	42/32	AC	3	Y		Y		Y	Y	L&R bikelines proposed	100	100	New		
Main (Hwy 193?)	Polk to boat landing	Arterial	Arterial	ODOT	317	42	AC	2	Y		Y		Y	Y	L&R bikelines proposed			Poor		
Main (Hwy 193?)	Boat landing to Picture	Arterial	Arterial	ODOT	264	42	AC	2	Y		Y		Y	Y	L&R bikelines proposed			Poor		
Main (Hwy 193?)	Picture to Williams	Arterial	Arterial	ODOT	264	42	AC	2	Y		Y		Y	Y	L&R bikelines proposed			Poor		
Main (Hwy 193?)	Williams to Grand	Arterial	Arterial	ODOT	370	42	AC	2	Y		Y		Y	Y	L&R bikelines proposed			Poor		
Main (Hwy 193?)	Grand to Oak	Arterial	Arterial	ODOT	317	42	AC	2	Y		Y		Y	Y	L&R bikelines proposed			Poor		
Main (Hwy 193?)	Oak to B	Arterial	Arterial	ODOT	1267	42	AC	2	Y		Y		Y	Y	L&R bikelines proposed			Poor		
Main (Hwy 193?)	B to C	Arterial	Arterial	ODOT	317	42	AC	2	Y		Y		Y	Y	L&R bikelines proposed			Good		
Main (Hwy 193?)	C to Monmouth	Arterial	Arterial	ODOT	264	42	AC	2	Y		Y		Y	Y	L&R bikelines proposed			Good		
<b>Hwy 193 Subtotal</b>																				
<b>UGB Monmouth</b>																				
Main	Monmouth to D	Arterial	Arterial	Independence	7778	288	AC	2	Y	90%	Y		Y	Y	L&R bikelines proposed	96	80	68		
Main	D to E	Arterial	Arterial	Independence	288	45	AC	2	Y	65%	Y		Y	Y	L&R bikelines proposed	90	30	67		
Main	E to F	Arterial	Arterial	Independence	297	34	AC	2	Y	N	30%	N	N	N	L&R bikelines proposed	30	-	59		
Main	F to G	Arterial	Arterial	Independence	297	34	AC	2	Y	N	Y	N	N	N	L&R bikelines proposed	20	-	67		
Main	G to H	Arterial	Arterial	Independence	288	34	AC	2	Y	N	Y	N	N	N	L&R bikelines proposed	22	-	54		
Main	H to I	Arterial	Arterial	Independence	288	34	AC	2	Y	N	Y	N	N	N	L&R bikelines proposed	58	-	61		
Convallis Hwy (Main)	I to south UGB	Arterial	Arterial	County	3700		AC	2	Y		Y		Y	Y	L&R bikelines proposed	-	-	-	With no improvement	
Walnut	Polk to boat landing	Collector	Collector	Independence	13224	24	AC	2	N	N	N	N	N	N		-	-	-	73	
Walnut	Boat landing to Picture	Collector	Collector	Independence	275	24	AC	2	N	N	N	N	N	N		-	-	-	60	
Walnut	Picture to Williams	Collector	Collector	Independence	287	23	AC	2	N	N	N	N	N	N		-	-	-	63	
<b>838</b>																				

Street	Section	Existing Functional Class	Future Functional Class	Length (ft)	Pavement Width (ft)	Surface	Lane Number	Right* Sidewalk	Left* Sidewalk	Right* Curb	Left* Curb	Right* Bike Facility	Left* Bike Facility	Other/Notes	1993 Rt Sidewalk Condition	1993 Lt Sidewalk Condition	1993 Street Condition	2006 Street Condition
4th	A to B	Collector	Collector	302	30	AC	2	Y	Y	Y	Y	N	N		95	65	59	Fair
4th	B to C	Collector	Collector	301	30	AC	2	Y	Y	Y	Y	N	N		95	92	Fair	Fair
4th	C to Memmouth	Collector	Collector	295	30	AC	2	Y	Y	Y	Y	N	N		96	100	Fair	Fair
4th	Memmouth to D	Collector	Collector	297	30	AC	2	Y	Y	Y	Y	N	N		96	20	Poor	Poor
4th	D to E	Collector	Collector	297	30	AC	2	Y	Y	Y	Y	N	N		100	75	90	90
4th	E to F	Collector	Collector	302	30	AC	2	Y	Y	Y	Y	N	N		100	88	84	84
4th	F to G	Collector	Collector	299	30	AC	2	Y	Y	Y	Y	N	N		96	88	84	84
4th	G to H	Collector	Collector	292	30	AC	2	Y	Y	Y	Y	N	N		100	50	87	87
4th	H to I	Collector	Collector	260	30	AC	2	Y	Y	Y	Y	N	N		100	98	87	87
4th	I to Evergreen	Collector	Collector	226	34	AC	2	N	N	Y	25%	N	N	Shoulder bikeway proposed	-	-	95	95
4th	Evergreen to Maple	Collector	Collector	402	34	AC	2	N	N	Y	Y	N	N	Shoulder bikeway proposed	-	-	94	94
4th	Maple to Spruce	Collector	Collector	223	33	AC	2	40%	40%	Y	Y	N	N	Shoulder bikeway proposed	75	100	96	96
4th	Spruce to Fir	Collector	Local	211	35	AC	2	Y	Y	Y	Y	N	N	Shoulder bikeway proposed	100	100	96	96
4th	Fir to south end	Collector	Local	506	36	AC	2	Y	20%	Y	Y	N	N	Shoulder bikeway proposed	96	100	92	92
<b>4213</b>																		
Ash	Williams to Albert	Collector	Collector	903	36	AC	2	N	N	N	N	N	N		-	-	64	64
Ash	Albert to Butler	Collector	Collector	275	36	AC	2	N	N	N	N	N	N		-	-	61	61
Ash	Butler to A	Collector	Collector	290	24	AC	2	N	N	N	N	N	N		-	-	69	69
<b>1468</b>																		
Stryker	Hoffman to Airport St	Collector	Collector	22	22	AC	2	N	N	3%	N	N	N	Shoulder bikeway proposed	-	-	-	-
Stryker	Airport St to Piper	Collector	Collector	22	22	AC	2	N	N	3%	N	N	N	Shoulder bikeway proposed	-	-	-	-
Stryker	Piper to Stinson	Collector	Collector	22	22	AC	2	N	N	3%	N	N	N	Shoulder bikeway proposed	-	-	-	-
Stryker	Stinson to Cessna	Collector	Collector	22	22	AC	2	N	N	3%	N	N	N	Shoulder bikeway proposed	-	-	-	-
Stryker	Cessna to Stearman	Collector	Collector	3015	22	AC	2	N	N	3%	N	N	N	Shoulder bikeway proposed	-	-	96	96
Stryker	Stearman to Skyrider	Collector	Collector	29	29	AC	2	N	N	50%	N	N	N	Shoulder bikeway proposed	-	-	-	-
Stryker	Skyrider to Main	Collector	Collector	2380	29	AC	2	N	N	50%	N	N	N	Shoulder bikeway proposed	-	-	-	-
<b>5395</b>																		
7th	Memmouth to D	Collector	Collector	297	36	AC	2	Y	Y	Y	Y	N	N		100	100	82	82
7th	D to E	Collector	Collector	300	34	AC	2	Y	Y	Y	Y	N	N		90	88	97	97
7th	E to F	Collector	Collector	297	36	AC	2	Y	Y	Y	Y	N	N		85	30	96	96
7th	F to G	Collector	Collector	296	36	AC	2	Y	Y	Y	Y	N	N		90	100	64	64
7th	G to Arbor	Collector	Collector	440	18	AC	2	Y	Y	N	Y	N	N		90	90	59	59
7th	Arbor to Riverwood	Collector	Collector	253	20	AC	2	Y	Y	N	Y	N	N		100	100	72	72
7th	Riverwood to Becken	Collector	Collector	420	13	AC	2	Y	N	N	Y	N	N		0	-	95	95
<b>South end to s UGB</b>																		
<b>Extension to 7th</b>																		
<b>2775</b>																		
<b>2303</b>																		
13th	Memmouth to D	Collector	Collector	291	36	AC	2	10%	Y	Y	Y	N	N		100	100	73	73
13th	D to E	Collector	Collector	294	36	AC	2	N	N	Y	Y	N	N		-	-	74	74
13th	E to F	Collector	Collector	242	26	AC	2	N	N	N	N	N	N		-	-	76	76
13th	F to south UGB	Collector	Collector	182	26	AC	2	Y	N	Y	N	N	N		100	-	77	77
<b>1109</b>																		
Gun Club	Hoffman to Picture	Arterial	Minor Arterial	1692	26	AC	2	N	N	N	Y	N	N	Shoulder bikeways proposed	-	-	97	97
Gun Club	Picture to Williams	Arterial	Minor Arterial	652	30	AC	2	N	N	N	Y	Bike lane	N	Shoulder bikeways proposed	-	-	96	96
Gun Club	Williams to Rhoda	Arterial	Minor Arterial	1330	30	AC	2	N	N	N	50%	Bike lane	N	Shoulder bikeways proposed	-	-	77	77
Gun Club	Rhoda to B	Arterial	Minor Arterial	225	24	AC	2	N	N	N	Y	Bike lane	N	Shoulder bikeways proposed	-	-	74	74
Gun Club	B to C	Arterial	Minor Arterial	236	24	AC	2	N	N	N	Y	Bike lane	N	Shoulder bikeways proposed	-	-	73	73
Gun Club	C to Memmouth	Arterial	Minor Arterial	315	26	AC	2	N	N	N	Y	Bike lane	N	Shoulder bikeways proposed	-	-	83	83

Street	Section	Existing Functional Class	Future Functional Class	Jurisdiction	Length (ft)	Pavement Width (ft)	Surface	Lane Number	Right* Sidewalk	Left* Sidewalk	Right* Curb	Left* Curb	Right* Bike Facility	Left* Bike Facility	Other/Notes	1993 Rt Sidewalk Condition	1993 Lt Street Condition	1993 Street Condition	2006 Street Condition
4450																			
Hoffman	West UGB to Gun Club	Arterial	Minor Arterial	County	1050	24	AC	2	N	N	N	N	Y	N	Proposed shoulder bikeways	-	-	-	-
Hoffman	Gun Club to James	Arterial	Minor Arterial	Independence	740	36	AC	2	N	N	N	N	Y	N	Proposed shoulder bikeways	-	100	100	100
Hoffman	James to Airport Rd	Arterial	Minor Arterial	Independence	3450	36	AC	2	Y	N	Y	Y	Y	N	Proposed shoulder bikeways	-	100	100	100
Hoffman	Airport Rd to Stryker	Arterial	Minor Arterial	Independence	1065	36	AC	2	Y	Y	Y	Y	Y	Y	Proposed shoulder bikeways	100	100	100	100
6305																			
Polk	Stryker to Walnut	Arterial	Minor Arterial	Independence	1020	36	AC	2	Y	Y	Y	Y	Y	Y	Proposed shoulder bikeways	10	100	100	100
Polk	Walnut to Log Cabin	Arterial	Minor Arterial	Independence	312	30	AC	2	N	N	Y	Y	N	N	Proposed shoulder bikeways	-	-	82	82
Polk	Log Cabin to Marsh	Arterial	Minor Arterial	Independence	300	26	AC	2	50%	N	Y	Y	N	N	Proposed shoulder bikeways	100	-	80	80
Polk	Marsh to Main	Arterial	Minor Arterial	Independence	275	29	AC	2	N	N	Y	Y	N	N	Proposed shoulder bikeways	-	-	80	80
1907																			
Williams	Ash to Walnut	Collector	Collector	Independence	275	36	AC	2	N	N	N	N	N	N	-	-	-	62	62
Williams	Walnut to Log Cabin	Collector	Collector	Independence	297	36	AC	2	N	N	N	N	N	N	-	-	-	61	61
Williams	Log Cabin to Marsh	Collector	Collector	Independence	318	36	AC	2	Y	N	N	N	N	N	100	100	-	79	79
Williams	Marsh to Main	Collector	Collector	Independence	278	36	AC	2	Y	Y	N	N	N	N	57	57	96	75	75
1168																			
A	Ash to 4th	Collector	Collector	Independence	142	22	AC	2	N	Y	N	N	N	N	-	-	0	78	78
142																			
Monmouth (Hwy 43)	Main to 2nd	Arterial	Arterial	ODOT	264	48	AC	2	Y	Y	Y	Y	Bike lane	Bike lane	-	-	-	Fair	Fair
Monmouth (Hwy 43)	2nd to 3rd	Arterial	Arterial	ODOT	370	38	AC	2	Y	Y	Y	Y	Bike lane	Bike lane	-	-	-	Fair	Fair
Monmouth (Hwy 43)	3rd to 4th	Arterial	Arterial	ODOT	370	38	AC	2	Y	Y	Y	Y	Bike lane	Bike lane	-	-	-	Fair	Fair
Monmouth (Hwy 43)	4th to 5th	Arterial	Arterial	ODOT	370	38	AC	2	Y	Y	Y	Y	Bike lane	Bike lane	-	-	-	Fair	Fair
Monmouth (Hwy 43)	5th to 6th	Arterial	Arterial	ODOT	422	38	AC	2	Y	Y	Y	Y	Bike lane	Bike lane	-	-	-	Fair	Fair
Monmouth (Hwy 43)	6th to 7th	Arterial	Arterial	ODOT	370	38/34	AC	2	Y	Y	Y	Y	Bike lane	Bike lane	-	-	-	Fair	Fair
Monmouth (Hwy 43)	7th to 8th	Arterial	Arterial	ODOT	422	34	AC	2	Y	Y	Y	Y	Bike lane	Bike lane	Built in summer of 1997	-	-	Fair	Fair
Monmouth (Hwy 43)	8th to 9th	Arterial	Arterial	ODOT	106	34/36	AC	2	Y	Y	Y	Y	Bike lane	Bike lane	Built in summer of 1997	-	-	Fair	Fair
Monmouth (Hwy 43)	9th to 10th	Arterial	Arterial	ODOT	422	46	AC	3	Y	Y	Y	Y	Bike lane	Bike lane	Built in summer of 1997	-	-	Fair	Fair
Monmouth (Hwy 43)	10th to 11th	Arterial	Arterial	ODOT	634	46	AC	3	Y	Y	Y	Y	Bike lane	Bike lane	Built in summer of 1997	-	-	Fair	Fair
Monmouth (Hwy 43)	11th to 12th	Arterial	Arterial	ODOT	370	46	AC	3	Y	Y	Y	Y	Bike lane	Bike lane	Built in summer of 1997	-	-	Fair	Fair
Monmouth (Hwy 43)	12th to 13th	Arterial	Arterial	ODOT	528	46	AC	3	Y	Y	Y	Y	Bike lane	Bike lane	Built in summer of 1997	-	-	Fair	Fair
Monmouth (Hwy 43)	13th to Gun Club	Arterial	Arterial	ODOT	581	46	AC	3	Y	Y	Y	Y	Bike lane	Bike lane	Built in summer of 1997	-	-	Fair	Fair
Monmouth (Hwy 43)	Gun Club to 16th	Arterial	Arterial	ODOT	1478	46	AC	3	Y	Y	Y	Y	Bike lane	Bike lane	Built in summer of 1997	-	-	Fair	Fair
Monmouth (Hwy 43)	16th to Talmadge Rd	Arterial	Arterial	ODOT	317	46	AC	3	Y	Y	Y	Y	Bike lane	Bike lane	Built in summer of 1997	-	-	Fair	Fair
Monmouth (Hwy 43)	Talmadge to 17th	Arterial	Arterial	ODOT	317	46	AC	3	Y	Y	Y	Y	Bike lane	Bike lane	Built in summer of 1997	-	-	Fair	Fair
Monmouth (Hwy 43)	Talmadge to west UGB	Arterial	Arterial	ODOT	422	46	AC	3	Y	Y	Y	Y	Bike lane	Bike lane	Built in summer of 1997	-	-	Fair	Fair
7763																			
16th	Main to Ash Creek	Local	Collector	Independence	1343	36	AC	2	Y	Y	Y	Y	Shared roadway	Shared roadway	100	100	100	100	100
Extension of 16th																			
3000																			
1343																			
South River Rd	Main to bridge	Collector	Collector	Independence	375	36	AC	2	Y	Y	Y	Y	Y	Y	N/A	-	-	100	100
375																			
Talmadge Road	Monmouth to south UGB	Collector	Collector	Independence	975	36	AC	2	Y	N	Y	N	Shoulder bikeway	Shoulder bikeway	100	N/A	100	100	100
975																			
722																			
238																			
437																			
1997																			
James St	Hoffman to Matthew	Local	Collector	Independence	437	36	AC	2	Y	Y	Y	Y	Y	Y	94	93	80	98	98
James St	Matthew to south end	Local	Collector	Independence	437	36	AC	2	Y	Y	Y	Y	Y	Y	94	93	80	98	98

Street	Section	Existing Functional Class	Future Functional Class	Jurisdiction	Length (ft)	Pavement Width (ft)	Surface	Lane Number	Right* Sidewalk	Left* Sidewalk	Right* Curb	Left* Curb	Right* Bike Facility	Left* Bike Facility	Other/Notes	1993 Rt Sidewalk Condition	1993 Lt Sidewalk Condition	1993 Street Condition	2006 Street Condition
<b>Extension of James St</b>																			
G Street	S end to Picture	Unbuilt	Collector	Independence	800	36	AC	2	Y	Y	Y	Y			N/A	N/A	N/A	N/A	
G Street	7th to 6th	Local	Collector	Independence	409	25	AC	2	N	Y	N	N							
G Street	6th to 5th	Local	Collector	Independence	410	23	AC	2	N	Y	N	N							
G Street	5th to 4th	Local	Collector	Independence	345	24	AC	2	N	Y	N	N							
G Street	4th to 3rd	Local	Collector	Independence	350	24	AC	2	N	Y	N	N							
G Street	3rd to 2nd	Local	Collector	Independence	230	36	AC	2	Y	Y	Y	Y							
G Street	2nd to Main	Local	Collector	Independence	403	36	AC	2	Y	Y	Y	Y							
<b>Spruce St</b>																			
Spruce St	4th to Hemlock Ln E	Local	Collector	Independence	204	36	AC	2	Y	Y	Y	Y							
Spruce St	W end to Pine Ct	Local	Collector	Independence	280	36	AC	2	Y	Y	Y	Y							
Spruce St	Pine Ct to Hemlock Ln E	Local	Collector	Independence	198	36	AC	2	Y	Y	Y	Y							
<b>Extension of Spruce St</b>																			
<i>Construct unnamed Southern collector</i>																			
	W end to w UGB (Talmadge)	Unbuilt	Collector	Independence	4950	36	AC	2	Y	Y	Y	Y			N/A	N/A	N/A	N/A	
	7th St extension to Conwallis Rd	Unbuilt	Collector	Independence	2700	36	AC	2	Y	Y	Y	Y			N/A	N/A	N/A	N/A	

\* Left or right is determined by following the direction of travel indicated by the sequence of segments

**Future Network**

Street	Section	Existing Functional Class	Future Functional Class	Jurisdiction	Length (ft)	Pavement Width (ft)	Surface	Lane Number	Right* Sidewalk	Left* Sidewalk	Right* Curb	Left* Curb	Right* Bike Facility	Left* Bike Facility	Other/Notes	1993 Rt Sidewalk Condition	1993 Lt Sidewalk Condition	1993 Street Condition	2006 Street Condition
<b>Existing Network</b>																			
SUMMARY		Total Linear Feet	Area	Ave Width	% of Total Length	Total Linear	% of Total												
Arterial		33,649	1,146,189	34.1	29	20,987	43												
Minor Arterial		17,986	423,521	23.5	15	12,662	26												
Local		65,579	1,905,401	28.1	56	15,256	31												
<b>Total</b>		<b>117,214</b>	<b>3,475,111</b>	<b>28.9</b>		<b>48,907</b>													
River	Polk to boat landing	Local			304	30	AC		N	N	Y	Y							74
River	Boat landing to Picture	Local			293	30	AC		Y	Y	Y	Y							100
Thorpe	Oak to Ash Creek	Local			100		G		N	N	N	N							100
Marsh	Polk to boat landing	Local			274	12	AC		N	N	N	N							100
Marsh	Boat landing to Picture	Local			284	12	AC		N	N	N	N							100
Marsh	Picture to Williams	Local			288	12	AC		N	N	N	N							100
Marsh	Williams to Grand	Local			285	12	AC		N	N	N	N							100
Marsh	Grand to Oak	Local			270	12	AC		N	N	N	N							100
2nd	B to C	Local			289	50	AC		Y	Y	Y	Y							59
2nd	C to Monmouth	Local			287	44	AC		Y	Y	Y	Y							70
2nd	Monmouth to D	Local			294	44	AC		Y	Y	Y	Y							64
2nd	D to E	Local			298	41	AC		Y	70%	Y	Y							68
Log Cabin	Polk to boat landing	Local			274	24	AC		60%	20%	N	N							63
Log Cabin	Boat landing to Picture	Local			273	24	AC		N	Y	N	N							100
Log Cabin	Picture to Williams	Local			279	22	AC		N	N	N	N							100
Log Cabin	Grand to Ash Creek	Local			214	21	AC		85%	N	N	N							79
Log Cabin	Butler to A	Local			305	21	AC		Y	95%	N	N							100
3rd	A to B	Local			302	30	C		Y	Y	90%	Y							66
3rd	B to C	Local			295	30	C		Y	Y	Y	Y							74
3rd	C to Monmouth	Local			295	29	C		Y	Y	Y	Y							88
3rd	Monmouth to D	Local			296	29	C		Y	Y	Y	Y							75
3rd	D to E	Local			302	29	C		Y	Y	Y	Y							80
3rd	E to F	Local			288	29	C		Y	N	Y	Y							91
3rd	F to G	Local			311	29	C		Y	N	Y	50%							70
3rd	G to H	Local			322	23	AC		Y	N	Y	50%							65
3rd	H to I	Local			319	24	AC		Y	N	N	N							92
Walnut	Hoffman to Polk	Local			213	30	AC		N	N	75%	Y							84
Walnut	Williams to Ash Creek	Local			247	26	AC		N	N	N	N							84
Walnut	Albert to Butler	Local			268	29	AC		Y	Y	Y	Y							68
Walnut	Butler to A	Local			293	29	AC		Y	Y	Y	Y							80
Evergreen	Evergreen to >>>>	Local			756	34	AC		N	N	N	N							100
Ash	Picture to Williams	Local			285	13	G		N	N	N	N							Gravel
5th	A to B	Local			262	30	AC		Y	Y	Y	Y							96
5th	C to Monmouth	Local			294	30	AC		Y	Y	Y	Y							95



Street	Section	Existing Functional Class	Future Functional Class	Jurisdiction	Length (ft)	Pavement Width (ft)	Surface	Lane Number	Right* Sidewalk	Left* Sidewalk	Right* Curb	Left* Curb	Right* Bike Facility	Left* Bike Facility	Other/Notes	1993 Rt Sidewalk Condition	1993 Lt Sidewalk Condition	1993 Street Condition	2006 Street Condition
Boat landing	Log Cabin to Marsh	Local	Local		317	20	AC		81%	N	N	N	N	N		96		75	
Boat landing	Marsh to Main	Local	Local		276	20	AC		N	N	N	N	N	N				Gravel	82
Boat landing	Main to River Dr	Local	Local		253	15	G		N	N	N	N	N	N				92	
Picture Pl	Gun Club to 13th	Local	Local		722	36	AC		Y	Y	Y	Y	Y	Y		86	86	98	
Picture Pl	13th to 12th	Local	Local		236	36	AC		Y	Y	Y	Y	Y	Y		94	93	70	
Picture Pl	12th to >>>>	Local	Local		437	36	AC		Y	Y	Y	Y	Y	Y				89	
Picture Pl	Ash to Walnut	Local	Local		263	24	AC		N	N	N	N	N	N				88	
Picture Pl	Log Cabin to Marsh	Local	Local		316	24	AC		N	N	N	N	N	N				88	
Picture Pl	Marsh to Main	Local	Local		276	24	AC		N	N	N	N	N	N				89	
Picture Pl	Main to River Dr	Local	Local		144	30	AC		N	N	N	N	N	N				93	
Howard	<<<<<< to 12th	Local	Local		263	30	AC		Y	Y	Y	Y	Y	Y		100		67	
Richard	<<<<<< to 13th	Local	Local		241	28	AC		Y	Y	Y	Y	Y	Y		88	98	76	
Williams	Gun Club to Wildfang	Local	Local		492	34	AC		Y	Y	Y	Y	Y	Y		100	100	82	
Williams	Wildfang to 13th	Local	Local		236	34	AC		Y	Y	Y	Y	Y	Y		100	100	83	
Dale	12th to >>>>	Local	Local		262	34	AC		80%	80%	Y	Y	Y	Y		100	100	87	
Kelli	12th to >>>>	Local	Local		260	30	AC		Y	Y	Y	Y	Y	Y		85	95	87	
Grand	Log Cabin to Marsh	Local	Local		318	24	AC		Y	N	81%	N	N	N		100		83	
Grand	Marsh to Main	Local	Local		274	30	AC		Y	N	Y	Y	Y	Y				78	
Scott	12th to >>>>	Local	Local		239	30	AC		Y	Y	Y	Y	Y	Y		100	100	95	
Dawn	<<<<<< to 12th	Local	Local		132	34	AC		Y	Y	Y	Y	Y	Y		100	100	96	
Kyle	12th to >>>>	Local	Local		187	28	AC		Y	Y	Y	Y	Y	Y		100	100	96	
Oak	Marsh to Main	Local	Local		255	24	AC		N	N	N	N	N	N				86	
Butler	Ash to Walnut	Local	Local		261	30	AC		94%	70%	Y	Y	Y	Y		96	23	68	
Butler	Walnut to Log Cabin	Local	Local		285	19	AC		Y	Y	N	N	N	N		95	83	60	
A	4th to Walnut	Local	Local		97	30	AC		Y	Y	Y	Y	Y	Y		95	100	79	
A	Walnut to 3rd	Local	Local		220	30	AC		Y	Y	Y	Y	Y	Y		90	80	80	
A	3rd to Log Cabin	Local	Local		185	30	AC		N	N	Y	Y	Y	Y				86	
Rhoda	Gun Club to North Way	Local	Local		582	34	AC		N	N	Y	Y	Y	Y				96	
B	Gun Club to North Way	Local	Local		582	34	AC		N	N	Y	Y	Y	Y				78	
B	7th to 6th	Local	Local		340	20	AC		N	N	N	N	N	N				84	
B	5th to 4th	Local	Local		349	30	AC		Y	Y	Y	Y	Y	Y		96	94	87	
B	4th to 3rd	Local	Local		347	30	C		Y	Y	Y	Y	Y	Y		97	94	Fair	
B	3rd to 2nd	Local	Local		343	32	AC		Y	Y	Y	Y	Y	Y		84	60	Fair	
B	2nd to Main	Local	Local		331	42	AC		Y	Y	Y	Y	Y	Y		93	95	58	
C	Gun Club to 13th	Local	Local		547	34	AC		N	N	Y	Y	Y	Y				80	
C	7th to 6th	Local	Local		346	30	AC		Y	Y	Y	Y	Y	Y		85	96	82	
C	6th to 5th	Local	Local		412	30	AC		Y	Y	Y	Y	Y	Y		80	75	67	
C	5th to 4th	Local	Local		345	30	AC		Y	Y	Y	Y	Y	Y		50	50	Poor	
C	4th to 3rd	Local	Local		350	30	AC		Y	Y	Y	Y	Y	Y		92	89	Fair	
C	3rd to 2nd	Local	Local		343	30	AC		Y	Y	Y	Y	Y	Y		95	50	Poor	
C	2nd to Main	Local	Local		335	44	C		Y	Y	Y	Y	Y	Y		100	100	Fair	
D	13th to 12th	Local	Local		475	34	AC		N	N	Y	Y	Y	Y				75	
D	12th to 11th	Local	Local		371	34	AC		N	N	N	N	N	N				72	
D	<<<<<< to 10th	Local	Local		332	20	G		N	N	N	N	N	N				Good	
D	10th to 9th	Local	Local		346	24	AC		95%	N	N	N	N	N				95	
D	9th to 8th	Local	Local		184	24	AC		N	50%	N	N	N	N		100	100	86	
D	Ash Cr to 7th	Local	Local		214	25	AC		N	N	N	N	N	N				80	
D	7th to 6th	Local	Local		345	24	AC		N	40%	N	N	N	N				80	
D	6th to 5th	Local	Local		410	36	AC		Y	Y	Y	Y	Y	Y				69	
D	5th to 4th	Local	Local		345	30	C		Y	Y	Y	Y	Y	Y		92	98	88	
D	4th to 3rd	Local	Local		350	30	AC		Y	Y	Y	Y	Y	Y		96	65	64	
D	3rd to 2nd	Local	Local		337	38	AC		Y	Y	Y	Y	Y	Y		94	40	63	
D	2nd to Main	Local	Local		334	38	AC		Y	Y	Y	Y	Y	Y				76	
E	13th to 12th	Local	Local		478	34	AC		N	N	Y	Y	Y	Y				77	
E	12th to 11th	Local	Local		363	36	AC		Y	N	Y	Y	Y	Y		100		95	
E	11th to 10th	Local	Local		640	36	AC		15%	25%	Y	Y	Y	Y		100	100	94	
E	10th to 9th	Local	Local		351	24	AC		Y	N	N	N	N	N				80	
E	9th to 8th	Local	Local		178	24	AC		Y	N	N	N	N	N		35	35	92	
E	Ash Cr to 7th	Local	Local		221	24	AC		Y	N	N	N	N	N		95	79	79	
E	7th to 6th	Local	Local		345	23	AC		Y	N	N	N	N	N		90	80	79	
E	6th to 5th	Local	Local		408	36	AC		Y	Y	Y	Y	Y	Y		87	85	75	

Street	Section	Existing Functional Class	Future Functional Class	Jurisdiction	Length (ft)	Pavement Width (ft)	Surface	Lane Number	Right* Sidewalk	Left* Sidewalk	Right* Curb	Left* Curb	Right* Bike Facility	Left* Bike Facility	Other/Notes	1993 Rt Sidewalk Condition	1993 Lt Sidewalk Condition	1993 Street Condition	2006 Street Condition
E	5th to 4th	Local			344	30	AC		Y	Y	Y	Y			100	97	65		
E	4th to 3rd	Local			347	30	AC		Y	Y	Y	Y			94	98	53		
E	3rd to 2nd	Local			301	30	AC		60%	Y	Y	Y			80	80	57		
E	2nd to Main	Local			334	38	AC		Y	50%	Y	Y			65	85	58		
F	10th to 9th	Local			347	18	AC		Y	Y	N	N					75		
F	9th to 8th	Local			195	19	AC		N	N	N	N					79		
F	8th to 7th	Local			551	34	AC		Y	N	Y	Y			90		72		
F	7th to 6th	Local			346	32	AC		Y	30%	Y	Y			100	100	69		
F	6th to 5th	Local			409	32	AC		Y	Y	Y	Y			90	100	72		
F	5th to 4th	Local			346	32	AC		Y	50%	Y	Y			95	100	79		
F	4th to 3rd	Local			351	32	AC		Y	10%	Y	Y			50	100	84		
G	Ash Cr to 7th	Local			249	25	AC		Y	N	N	N			100		77		
G	7th to 6th	Local			409	23	AC		N	Y	N	N				90	73		
G	6th to 5th	Local			410	24	AC		N	Y	N	N				55	73		
G	5th to 4th	Local			346	24	AC		N	Y	N	N				94	80		
G	4th to 3rd	Local			350	24	AC		Y	Y	N	N			90	70	66		
G	3rd to 2nd	Local			230	24	AC		N	Y	N	N					80		
G	2nd to Main	Local			403	24	AC		N	Y	N	N				90	84		
H	4th to 3rd	Local			355	22	AC		Y	Y	Y	Y			100	100	100		
H	2nd to Main	Local			190	17	AC		Y	Y	Y	Y			100	100	100		
H	7th to >>>>	Local			356	30	AC		Y	Y	Y	Y			100	100	79		
I	5th to 4th	Local			331	26	AC		N	40%	50%	N				85	85		
I	4th to 3rd	Local			355	24	AC		N	N	N	N					85		
I	2nd to Main	Local			494	34	AC		Y	N	Y	Y			90	100	94		
I	7th to >>>>	Local			304	30	AC		Y	60%	Y	Y			100	100	75		
Evergreen	4th to Evergreen	Local			756	34	AC		N	N	Y	Y					80		
Maple Ct	<<<<< to Maple	Local			661	34	AC		N	N	Y	Y					Poor		
Hemlock Ln	W Spruce >> E Spruce	Local			1697	0	AC		Y	Y	Y	Y			88	94	Poor		
Spruce	<<<<< to Hemlock E	Local			280	36	AC		Y	Y	Y	Y			100	75	92		
Spruce	Pine to Hemlock E	Local			196	36	AC		Y	Y	Y	Y			100	75	87		
Spruce	Hemlock to 4th	Local			204	36	AC		Y	Y	Y	Y			100	100	92		
Spruce	4th to >>>>	Local			206	34	AC		Y	Y	Y	Y			100	91	87		
Fir	4th to >>>>	Local			148	34	AC		Y	Y	Y	Y			100	94	91		





## **APPENDIX B**

**Traffic Data and Analysis  
Sections B-1 through B-6**



**APPENDIX SECTION B-1**  
**Traffic Operations Summary**



# Traffic Operations

The purpose of this Chapter is to document traffic operations for the TSP roadways and intersections for the following scenarios:

- 2006 (Balanced 30 HV)
- 2026 Without Improvements
- 2026 With Improvements
- Full UGB Build-Out Without Improvements (2042)
- Full UGB Build-Out With Improvements (2042)

This includes an examination of traffic control and geometrics, traffic volumes, intersection levels of service and V/C analysis.

## 1.1 OPERATIONAL STANDARDS

Within the state of Oregon, traffic operations are evaluated based on two sets of criteria or standards. For many local communities, the quality of traffic performance is assessed in terms of intersection or roadway levels of service (LOS). For state highways, the operative standard is expressed in terms of a volume to capacity (V/C) ratio which is the ratio between traffic volumes and the roadway or intersection's capacity. The City of Independence currently uses LOS standards, however a change to V/C standards is being considered as part of the TSP update. The two operational standards are described below.

### Volume-to-Capacity Ratios

As adopted in the 1999 OHP, ODOT uses volume-to-capacity (V/C) ratios to measure state highway performance rather than intersection or roadway levels of service. Various V/C thresholds are applied to all state highways based on the functional classification and highway segment designation of these facilities. Both Highway 193 and 43 (Oregon 51) are district level, non-freight routes inside a non-MPO municipal UGB. In addition, the following highway segment designations apply to portions of these highways:

- Urban Business Area (UBA): Highway 193 (Oregon 51) from Stryker Street to Polk Street (milepoint 4.86 to 5.70)
- Special Transportation Area (STA): Highway 193 (Oregon 51) from B Street to Monmouth Street (milepoint 6.23 to 6.34) and Highway 43 from Main Street to 4th Street (milepoint 2.35 to 2.14)
- Commercial Center (CC): Highway 43 (Oregon 51) from 10th Street to the Independence City Limits (milepoint 1.70 to 0.76)

The peak hour, maximum V/C standards for the various sections of Highway 193 and 43 (Oregon 51) are summarized below.

### Highway 193 and 43 (Oregon 51) Peak Hour, Maximum V/C Standards

District Highway, Inside UGB, Non-MPO Designations	Maximum V/C Ratio
STA	0.95
Posted speed ≤35 mph or UBA	0.90
Posted speed >35 mph	0.85
Posted speed ≥45 mph	0.80

Source: Oregon Highway Plan, Policy 1F Mobility Standards, Table 6.

### Intersection Levels of Service

Intersection traffic volumes are evaluated to determine the level of operating performance that occurs within peak travel periods. Operating performance is based on an assessment of average control delay per vehicle entering the intersection. This delay is calculated using equations that take into account turning movement volumes, intersection lane geometry and traffic signal features, as well as characteristics of the traffic stream passing through the intersection, including time required to slow, stop, wait, and accelerate to move through the intersection. Various levels of delay are then expressed in terms of levels of service (LOS) for either signalized or unsignalized intersections. The various levels of service range from LOS A (which reflects free-flow conditions) through LOS F (which reflects operational breakdown). Between LOS A and LOS F, progressively higher LOS grades reflect increasingly worse intersection performance, with higher levels of control delay and increased congestion and queues. Characteristics of each LOS are briefly described below.

#### Level of Service Definitions

Level of Service	Average Delay/Vehicle (sec.)		Description
	Signalized	Unsignalized	
A (Desirable)	<10 seconds	<10 seconds	Very low delay; most vehicles do not stop.
B (Desirable)	>10 and <20 seconds	>10 and <15 seconds	Low delay resulting from good progression, short cycle lengths, or both.
C (Desirable)	>20 and <35 seconds	>15 and <25 seconds	Higher delays with fair progression, longer cycle lengths, or both.
D (Acceptable)	>35 and <55 seconds	>25 and <35 seconds	Noticeable congestion with many vehicles stopping. Individual cycle failures occur.
E (Unsatisfactory)	>55 and <80 seconds	>35 and <50 seconds	High delay with poor progression, long cycle lengths, high V/C ratios, and frequent cycle failures.
F (Unsatisfactory)	>80 seconds	>50 seconds	Very long delays, considered unacceptable by most drivers. Often results from over-saturated conditions or poor signal timing.

Source: 2000 Highway Capacity Manual, Transportation Research Board.

The analysis of traffic operations was conducted using a Synchro traffic simulation model which was developed specifically for study area intersections. This model includes the field-verified geometrics and other relevant physical data for each intersection, as well as existing traffic control. Analysis procedures follow the ODOT Transportation Planning and Analysis Unit's (TPAU) guidelines.

## 1.2 EXISTING OPERATIONS

### Intersection Traffic Control

The analysis of existing traffic conditions within the City of Independence focuses on nine key intersections located throughout the City. These intersections are:

1. Hoffman Road at 16th Street (unsignalized)
2. Hoffman Road at Gun Club Road (unsignalized)
3. Monmouth Street (OR 51) at 16th Street (signalized)
4. Monmouth Street (OR 51) at Gun Club Road (signalized)
5. Monmouth Street (OR 51) at 7th Street (unsignalized)
6. Main Street (OR 51) at Polk Street (unsignalized)
7. Main Street (OR 51) at Stryker Street (unsignalized)
8. Main Street at 'G' Street (unsignalized)
9. Main Street (OR 51) at Monmouth Street (OR 51) (3-way stop controlled)

Each of the unsignalized intersections is stop-controlled on the minor street approach. Two of the intersections operate with traffic signals, one as a three way stop. Existing lane configurations and traffic control for the nine study area intersections are shown in Section B-3.

### Traffic Volumes

ODOT provided turning movement counts for seven of the study intersections, the two remaining were supplied by the City of Independence. A review of traffic count data indicated that City streets traffic activity peaked from 5 pm to 6 pm. Independence traffic is characterized as commuter with some season changes in traffic patterns and commuting between cities. Traffic volumes vary with the seasons and adjustments are required for the counts taken outside of the peak season to ensure that they reflect appropriate conditions for use in assessing design/improvement options. The turning movement volume figures in Section B-3 reflects the raw traffic count data and volumes with the application of a seasonal adjustment to ensure that analysis of current operating performance is based on the 30th highest hour conditions. See Section B-4, for a summary of the assumptions used in preparing the traffic volume seasonal adjustments and growth rates.

## 1.3 2006 TRAFFIC OPERATIONS

### Summary of Existing Traffic Operations

Intersection analysis worksheets and traffic analysis methodology are included in Section B-3 and Section B-4, respectively. Currently the intersections generally experience minimal delays and operate within the acceptable LOS standards. The northbound approach of 7th Street experiences the greatest delay.

### 2006 (30 HV) Operations at Key Intersections in Independence

Signalized Intersections		V/C Ratio	Average Delay (sec/vehicle)	LOS
Monmouth St. (OR 51) @ 16th Street		0.56	36.7	D
Monmouth St. (OR 51) @ Gun Club Road		0.70	31.1	C
Unsignalized Intersections	Critical Movement	Critical V/C Ratio	Critical Delay (seconds/vehicle)	Critical LOS
Hoffman Road @ Gun Club Road	Northbound	0.33	15.6	C
Hoffman Road @ 16th Street	Northbound	0.17	12.7	B
Monmouth St. (OR 51) @ 7th Street	Northbound	0.52	48.0	E
	Southbound	0.07	17.1	C
Main St. (OR 51) @ Polk Street	Eastbound	0.38	18.9	C
	Westbound	0.05	17.0	C
Main St. (OR 51) @ Stryker Street	Northbound	0.01	8.4	A
	Eastbound	0.28	18.2	C
Main St. (OR 51) @ Monmouth St. (OR 51)	All-Way Stop		17.1	C
Main St. @ 'G' Street	Eastbound	0.35	20.6	C

Note 1: LOS means intersection level of service.

Note 2: "Critical Delay" and "Critical LOS" refers to the delay or LOS experienced for the specific intersection traffic movement listed

## 1.4 FUTURE TRAFFIC OPERATIONS

Future traffic operations analysis was conducted for four alternatives, two alternatives for the year 2026 and two for full UGB build-out, which is estimated to occur in 2042.

- Alternative 1 – 2026 Without Improvements
- Alternative 2 – 2026 With Improvements
- Alternative 3 – Full UGB Build-Out Without Improvements (2042)
- Alternative 4 – Full UGB Build-Out With Improvements (2042)

### Intersection Improvements

Alternative 1 and 3 retain the same intersection geometry and traffic control as the existing conditions. Alternative 2 and 4 includes the following improvements (see next page).



**Alternative 2–2026 With Arterial Transportation System Capital Improvements Program**

<b>Project Type</b>	<b>Project Description</b>	<b>Source</b>
Safety/Multimodal	Hoffman/Gun Club Road intersection add NB left turn lane	Analysis
Safety/Multimodal	Hoffman/16th Intersection add NB left turn lane	Analysis
Congestion Relief Safety/Multi-modal	Polk Street/Main add EB left turn lane	Analysis
Congestion Relief	Monmouth/Gun Club Road Intersection add SB left turn lane	Analysis
Congestion Relief	Monmouth/Main-install directional circulator ('C' Street to Monmouth) to accommodate SB to WB traffic.	Analysis
Congestion Relief/High Capital	New Arterial Roadway from Corvallis Rd to OR 99 with limited access	Analysis
Congestion Relief/High Capital	New Arterial Roadway overcrossing at W&P tracks	Analysis
Congestion Relief/High Capital	New North-South Collector Roadways between new arterial and Monmouth at Talmadge, 13th and 7th	Analysis

**Alternative 4–Full UGB Build Out (2042) With Arterial Transportation System Capital Improvements Program\***

<b>Project Type</b>	<b>Project Description</b>	<b>Source</b>
Congestion Relief/Safety/Multi-modal	7 <sup>th</sup> /Monmouth add NB left turn lane.	Analysis
Congestion Relief Safety/Multi-modal	Polk Street/Main install signal	Analysis
Congestion Relief Safety/Multi-modal	Monmouth/Main install signal	Analysis
Safety/Multimodal	'G" Street/Main Street Intersection add left turn lane	Analysis
Safety/Multimodal	Install roundabouts at new arterial intersections	

\*These projects are in addition to the Alternative 2-2026 With Arterial Transportation System Capital Improvements Program

The centerpiece of improvements is a new Arterial Roadway running parallel to, and to the South of, Monmouth Street (OR 51). This new Arterial would provide a new travel route for those living and working in Southern Independence, and draw through traffic from South Salem to Monmouth.

To be an effective alternate route in lieu of Monmouth Street (OR 51), the new Arterial Roadway must:

- Be free of on-street parking and driveways
- Have limited intersections (Corvallis Rd, 7th, 13th, Talmadge/16th)
- Maintain travel speeds with minimal delay at intersections (no signals at 7th and 13th)
- Continue west and connect with OR 99 in the City of Monmouth

The design and alignment of the roadway will be the subject of a future refinement plan however, for planning purposes the roadway will in the interim be classified as a minor arterial according to the City of Independence standards. This standard includes two 12 foot travel lanes, bike lanes and sidewalks, with a posted speed of 35 mph or higher.

To protect function at Monmouth and Main, a directional circulator is needed from Main Street to Monmouth Street at 'C' Street. This improvement would divert the southbound (Main Street) to westbound (Monmouth Street) traffic from Oregon 51 and reroute it west onto 'C' Street, then south somewhere between 2<sup>nd</sup> and 5<sup>th</sup> Streets to rejoin Monmouth Street west. Because of existing constraints at Monmouth and Main Street, adding additional turn lanes are not feasible.

The improvements to intersection lane configurations and traffic control, and new roadway connections, are shown in figures found in Section B-4. Supporting analysis for signal warrants are also included in Section B-4.

### **Future Traffic Volumes and Distribution**

Future traffic volumes were estimated according to the Oregon Department of Transportation's (ODOT) Transportation Analysis Procedures Manual (APM) (2006) guidelines for cumulative analysis. The area within the City of Independence's Urban Growth Boundary (UGB) has been divided into 16 Traffic Analysis Zones (TAZs). Parametrix estimated the net buildable acreage for each TAZ, and used the acreage estimates to generate the estimated growth in trips to and from each TAZ by the year 2026 and at full UGB build-out (2042). Through trip growth was estimated using the growth method. Section B-4 describes the methodology in more detail. Future volumes are contained in Section B-5 for Alternative 1 and Alternative 2 and Section B-6 for Alternative 3 and Alternative 4.

Based on existing traffic patterns and discussions with City Staff, a redistribution of through trips was conducted for future scenarios. Hoffman Road is assumed to attract more trips for destinations north of Independence because of congestion along Monmouth (Oregon 51), attractiveness as a freight route, and lack of signals. The proposed new arterial is assumed to have little impact to volumes along Hoffman Road. The proposed new arterial would attract east/west through trips that would otherwise travel on Oregon 51 and trips destined for adjacent properties. Eighty percent of the through trips were reassigned to the new arterial. The remaining trips are internal to external or external to internal trips associated with the properties adjacent to the new arterial.

## Summary of Future Traffic Operations

The following tables summarize the operations for each of the alternatives.

### Alternative 1: 2026 without Improvements

#### Operations at Key Intersections in Independence

Signalized Intersections		V/C Ratio	Average Delay (sec/vehicle)	LOS
Monmouth St. (OR 51) @ 16th Street		0.70	63.3	E
Monmouth St. (OR 51) @ Gun Club Road		>1.00	>80.0	F
Unsignalized Intersections	Critical Movement	Critical V/C Ratio	Critical Delay (seconds/vehicle)	Critical LOS
Hoffman Road @ Gun Club Road	Northbound	0.81	45.4	E
Hoffman Road @ 16th Street	Northbound	0.31	14.5	B
Monmouth St. (OR 51) @ 7th Street	Northbound	>1.00	>80.0	F
	Southbound	>1.00	>80.0	F
Main St. (OR 51) @ Polk Street	Eastbound	0.99	94.0	F
	Westbound	0.72	>80.0	F
Main St. (OR 51) @ Stryker Street	Northbound	0.04	9.0	A
	Eastbound	0.42	29.1	D
Main St. (OR 51) @ Monmouth St. (OR 51)	Northbound	>1.00	>80.0	F
	Eastbound	>1.00	>80.0	F
Main St. @ 'G' Street	Eastbound	>1.00	>80.0	F

Note 1: LOS means intersection level of service.

Note 2: "Critical Delay" and "Critical LOS" refers to the delay or LOS experienced for the specific intersection traffic movement listed

### Alternative 2: 2026 with Improvements

#### Operations at Key Intersections in Independence

Signalized Intersections		V/C Ratio	Average Delay (sec/vehicle)	LOS
Monmouth St. (OR 51) @ 16th Street		0.52	29.3	C
Monmouth St. (OR 51) @ Gun Club Road		0.65	31.5	C
Unsignalized Intersections	Critical Movement	Critical V/C Ratio	Critical Delay (seconds/vehicle)	Critical LOS
Hoffman Road @ Gun Club Road	Northbound	0.51	32.6	D
Hoffman Road @ 16th Street	Northbound	0.28	14.3	C
Monmouth St. (OR 51) @ 7th Street	Northbound	0.57	37.1	E
	Southbound	0.49	27.3	D

**Alternative 2: 2026 with Improvements (Continued)**

**Operations at Key Intersections in Independence**

<b>Unsignalized Intersections</b>	<b>Critical Movement</b>	<b>Critical V/C Ratio</b>	<b>Critical Delay (seconds/vehicle)</b>	<b>Critical LOS</b>
Main St. (OR 51) @ Polk Street	Eastbound	0.47	36.7	E
	Westbound	0.47	48.8	E
Main St. (OR 51) @ Stryker Street	Northbound	0.02	8.9	A
	Eastbound	0.51	28.7	D
Main St. (OR 51) @ Monmouth St. (OR 51)	Northbound	0.71	19.8	C
	Eastbound	0.35	12.4	B
Main St. @ 'G' Street	Eastbound	0.43	22.0	C

Note 1: LOS means intersection level of service.

Note 2: "Critical Delay" and "Critical LOS" refers to the delay or LOS experienced for the specific intersection traffic movement listed

**Alternative 3: Full UGB Build-out without Improvements (2042)**

**Operations at Key Intersections in Independence**

<b>Signalized Intersections</b>	<b>V/C Ratio</b>	<b>Average Delay (sec/vehicle)</b>	<b>LOS</b>
Monmouth St. (OR 51) @ 16th Street	0.83	>80.0	F
Monmouth St. (OR 51) @ Gun Club Road	>1.00	>80.0	F

<b>Unsignalized Intersections</b>	<b>Critical Movement</b>	<b>Critical V/C Ratio</b>	<b>Critical Delay (seconds/vehicle)</b>	<b>Critical LOS</b>
Hoffman Road @ Gun Club Road	Northbound	>1.00	>80.0	F
Hoffman Road @ 16th Street	Northbound	0.38	16.3	C
Monmouth St. (OR 51) @ 7th Street	Northbound	>1.00	>80.0	F
	Southbound	>1.00	>80.0	F
Main St. (OR 51) @ Polk Street	Eastbound	>1.00	>80.0	F
	Westbound	>1.00	>80.0	F
Main St. (OR 51) @ Stryker Street	Northbound	0.08	9.5	A
	Eastbound	0.70	63.1	F
Main St. (OR 51) @ Monmouth St. (OR 51)	Northbound	>1.00	>80.0	F
	Eastbound	>1.00	>80.0	F
Main St. @ 'G' Street	Eastbound	>1.00	>80.0	F

Note 1: LOS means intersection level of service.

Note 2: "Critical Delay" and "Critical LOS" refers to the delay or LOS experienced for the specific intersection traffic movement listed

**Alternative 4: Full UGB Build-out with Improvements (2042)**

**Operations at Key Intersections in Independence**

<b>Signalized Intersections</b>		<b>V/C Ratio</b>	<b>Average Delay (sec/vehicle)</b>	<b>LOS</b>
Monmouth St. (OR 51) @ 16th Street		0.61	31.5	C
Monmouth St. (OR 51) @ Gun Club Road		0.74	35.0	D
Main St. (OR 51) @ Polk Street		0.79	18.6	B
Main St. (OR 51) @ Monmouth St. (OR 51)		0.79	15.6	B
<b>Unsignalized Intersections</b>	<b>Critical Movement</b>	<b>Critical V/C Ratio</b>	<b>Critical Delay (seconds/vehicle)</b>	<b>Critical LOS</b>
Hoffman Road @ Gun Club Road	Northbound Left	0.64	48.1	E
Hoffman Road @ 16th Street	Northbound	0.33	16.4	C
Monmouth St. (OR 51) @ 7th Street	Northbound Left	0.61	80.2	F
	Southbound	0.71	49.3	E
Main St. (OR 51) @ Stryker Street	Northbound	0.04	9.3	A
	Eastbound	0.71	52.6	F
Main St. @ 'G' Street	Eastbound Left	0.49	41.3	E

Note 1: LOS means intersection level of service.

Note 2: "Critical Delay" and "Critical LOS" refers to the delay or LOS experienced for the specific intersection traffic movement listed

Intersection analysis worksheets are contained in Section B-5 for Alternative 1 and Alternative 2 and Section B-6 for Alternative 3 and Alternative 4.



**APPENDIX SECTION B-2**  
**Volume-to-Capacity Thresholds**





Table 6: Maximum volume to capacity ratios for peak hour operating conditions \*

Maximum Volume to Capacity Ratios Outside Metro**							
Highway Category	Inside Urban Growth Boundary					Outside Urban Growth Boundary	
	STAs	MPO	Non-MPO Outside of STAs where non-freeway posted speed <= 35 mph, or a Designated UBA	Non-MPO outside of STAs where non-freeway speed > 35 mph	Non-MPO where non-freeway speed limit >= 45 mph	Unincorporated Communities	Rural Lands
Interstate Highways	N/A	0.80	N/A	0.70	0.70	0.70	0.70
Statewide Expressways	N/A	0.80	0.70	0.70	0.70	0.70	0.70
Freight Route on a Statewide Highway	0.85	0.80	0.80	0.75	0.70	0.70	0.70
Statewide (not a freight route)	0.90	0.85	0.85	0.80	0.75	0.75	0.70
Freight Route on a Regional or District Highway	0.90	0.85	0.85	0.80	0.75	0.75	0.70
Expressway on a Regional or District Highway	N/A	0.85	N/A	0.80	0.75	0.75	0.70
Regional Highways	0.95	0.85	0.85	0.80	0.75	0.75	0.70
District / Local Interest Roads	0.95	0.90	0.90	0.85	0.80	0.80	0.75

\* For Portland Metro and the Rogue Valley MPO see also OHP Amendment 00-04 amended Table 7 regarding Metro and established Alternative Mobility Standards for the RVMPO. Where there is a conflict between the Table 6 standards and the established alternative mobility standards, the more tolerant standard (higher v/c ratio) applies. The OHP amendments establishing the RVMPO and Metro alternative standards are located on the web at:

<http://www.oregon.gov/ODOT/TD/TP/docs/orhwyplan/registry/0004.pdf>

\*\* National Highway System (NHS) highway design requirements are addressed in the Highway Design Manual (HDM)



## **APPENDIX SECTION B-3**

### **Data and Analysis**



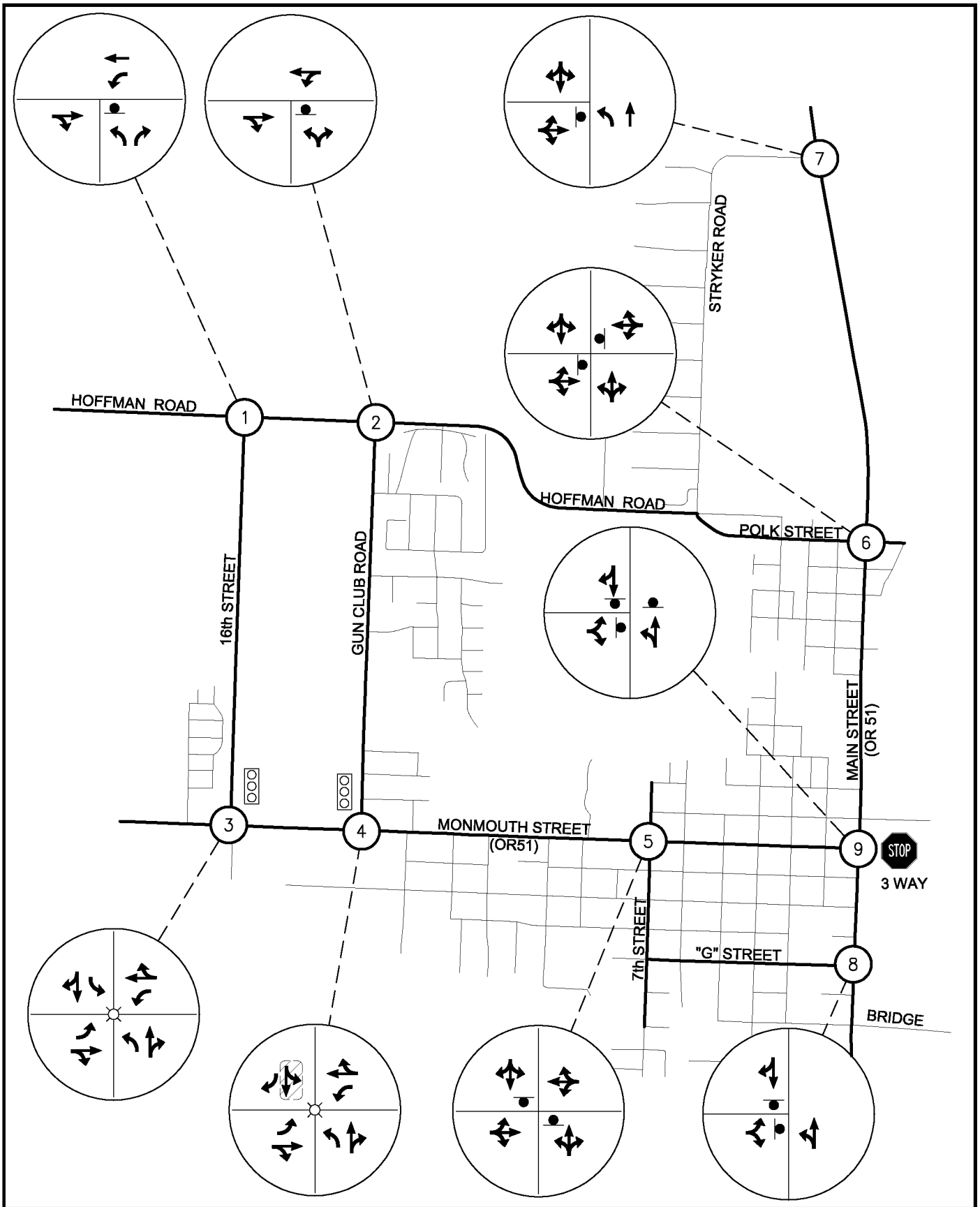

Parametrix DATE: May 01, 2007 FILE: PO2395051P05F-11

**LEGEND**

- SIGNALIZED INTERSECTION
- STOP CONTROLLED
- EXISTING TRAFFIC MOVEMENT
- MOVEMENT ADDED AFTER TRAFFIC ANALYSIS



**Figure 4**  
**Existing Intersection Geometry**  
 INDEPENDENCE, OREGON

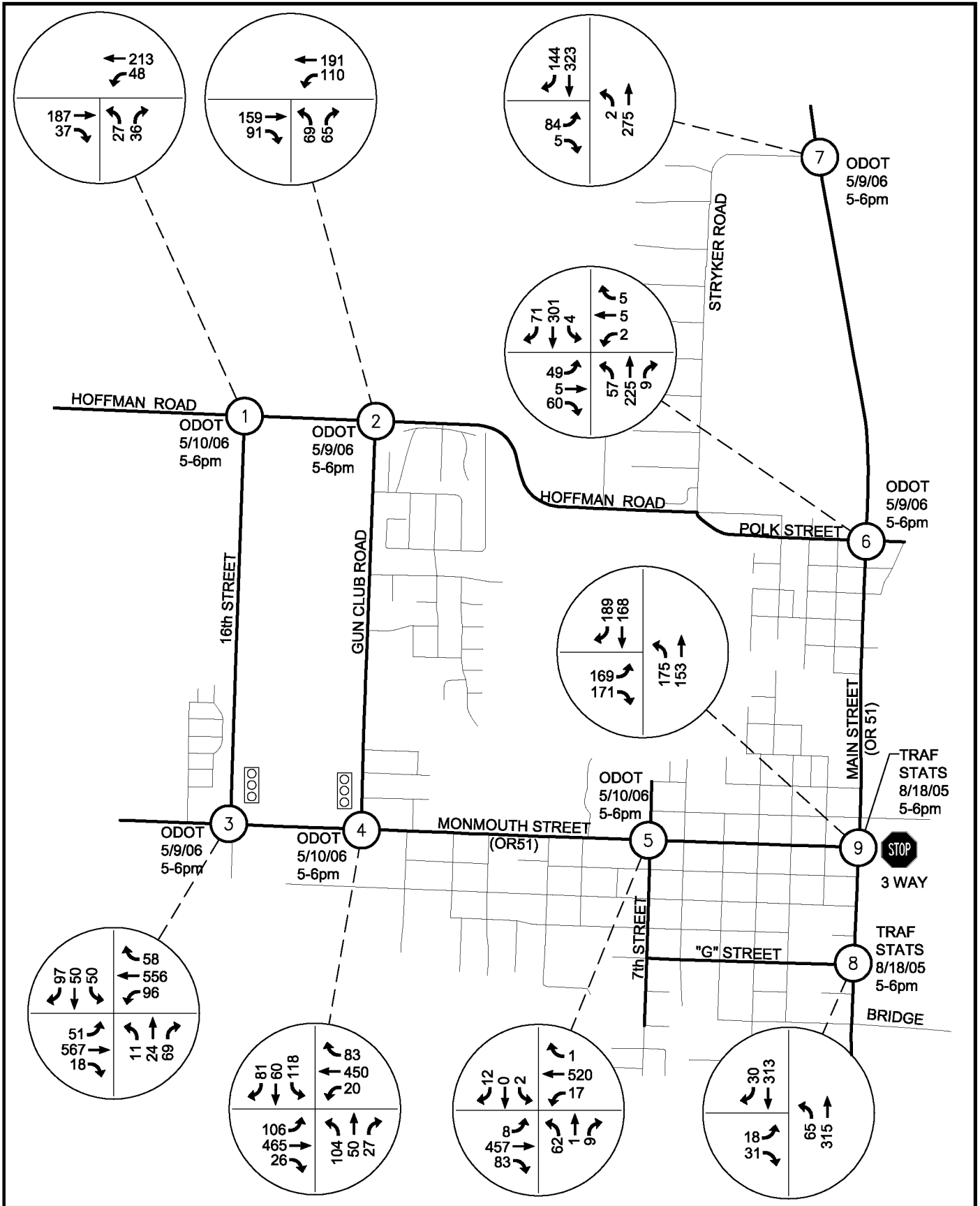

**LEGEND**

105 TURNING MOVEMENT BY DIRECTION OF TRAFFIC

**PM Peak Traffic Volumes Counts (Raw)**

INDEPENDENCE, OREGON

# Video Survey Field Sheet

TRAFSTATS PROJECT #

SURVEY DATE

05-202

8-18-05

LOCATION:

Main and G St

MAP PAGE

GRID

CITY:

Independence

TIME

4p-6p

WEATHER:  Sunny  Overcast  Rain  Snow  Fog

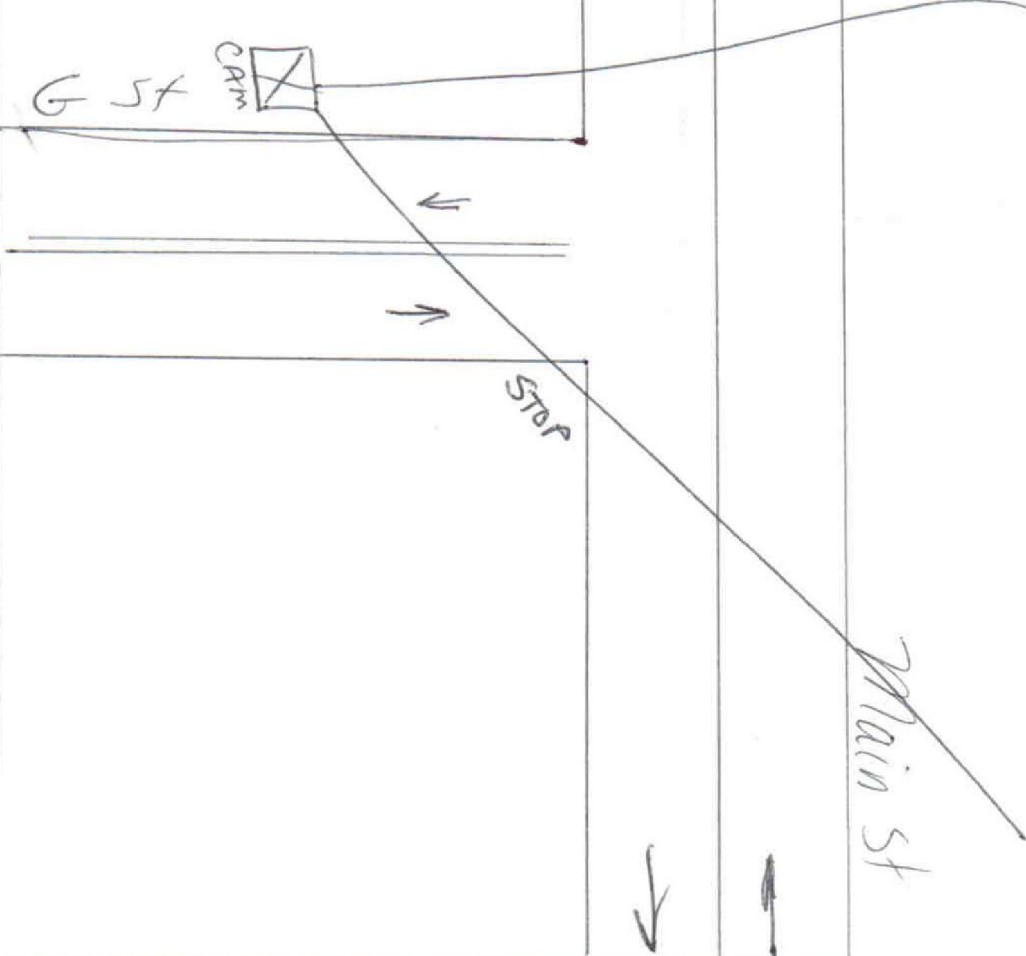

CAMERA - A		R
Number	C14	
Start 1st Film	Date: 8-18-05	
	Time: 2:49p	
	Film: T17	
	Batt: B5	
Start 2nd Film	Date:	
	Time:	
	Film:	
	Batt:	
Start 3rd Film	Date:	
	Time:	
	Film:	
	Batt:	
Start 4th Film	Date:	
	Time:	
	Film:	
	Batt:	
Start 5th Film	Date:	
	Time:	
	Film:	
	Batt:	
CAMERA - B		R
Number		
Start 1st Film	Date:	
	Time:	
	Film:	
	Batt:	
Start 2nd Film	Date:	
	Time:	
	Film:	
	Batt:	
Start 3rd Film	Date:	
	Time:	
	Film:	
	Batt:	
Start 4th Film	Date:	
	Time:	
	Film:	
	Batt:	
Start 5th Film	Date:	
	Time:	
	Film:	
	Batt:	

REMARKS:

Surveyed By:

DH / NB



1225 SW Murray Rd Suite 110  
Portland, OR 97229



## Intersection Turning Movement Summary Report

**Location** G STREET AT MAIN STREET  
**Date** 8/18/2005  
**Day of Week** Thursday  
**Time Begin** 16:00  
**Reviewed By:** BV

Time Period	Eastbound			Westbound			Northbound			Southbound			Totals
	Right	Thru	Left	Right	Thru	Left	Right	Thru	Left	Right	Thru	Left	
16:00 - 16:15	2	0	2	0	0	0	0	55	5	4	65	0	133
16:15 - 16:30	5	0	4	0	0	0	0	68	5	3	65	0	150
16:30 - 16:45	5	0	2	0	0	0	0	80	7	10	60	0	164
16:45 - 17:00	8	0	1	0	0	0	0	86	19	6	77	0	197
17:00 - 17:15	6	0	3	0	0	0	0	76	11	2	83	0	181
17:15 - 17:30	5	0	3	0	0	0	0	85	15	11	83	0	202
17:30 - 17:45	10	0	5	0	0	0	0	85	21	12	77	0	210
17:45 - 18:00	10	0	7	0	0	0	0	69	18	5	70	0	179
<b>Movement Totals</b>	<b>51</b>	<b>0</b>	<b>27</b>	<b>0</b>	<b>0</b>	<b>0</b>	<b>0</b>	<b>604</b>	<b>101</b>	<b>53</b>	<b>580</b>	<b>0</b>	<b>1416</b>
Enter Totals	78			0			705			633			
Exit Totals	0			154			631			631			

**Two-Hour Totals**

Light Trucks	0	0	1	0	0	0	0	5	2	1	6	0	15
Medium Trucks	0	0	0	0	0	0	0	12	0	0	11	0	23
Heavy Trucks	1	0	0	0	0	0	0	4	0	1	2	0	8
% Trucks	2.0%	NA	3.7%	NA	NA	NA	NA	3.5%	2.0%	3.8%	3.3%	NA	3.2%
Buses	0	0	0	0	0	0	0	0	0	0	0	0	0
Bicycles	0	0	0	0	0	0	0	6	0	0	12	0	18

	South	West	East	North	
Pedestrians	0	12	0	0	12

### Peak Hour Information

**Peak Hour 16:45 17:45**

	Eastbound			Westbound			Northbound			Southbound			Totals
	Right	Thru	Left	Right	Thru	Left	Right	Thru	Left	Right	Thru	Left	
Movement Total	29	0	12	0	0	0	0	332	66	31	320	0	790
Peak Hour Factor	0.73	NA	0.60	NA	NA	NA	NA	0.97	0.79	0.65	0.96	NA	0.94
Enter Totals	41			351			398			0			
Peak Hour Factor	0.68			0.93			0.94			NA			
Exit Totals	0			349			344			97			
Peak Hour Factor	NA			0.98			0.96			0.73			
Light Trucks	0	0	1	0	0	0	0	2	0	1	2	0	6
Medium Trucks	0	0	0	0	0	0	0	5	0	0	5	0	10
Heavy Trucks	1	0	0	0	0	0	0	2	0	0	1	0	4
% Trucks	3.4%	NA	8.3%	NA	NA	NA	NA	2.7%	0.0%	3.2%	2.5%	NA	2.5%
Buses	0	0	0	0	0	0	0	0	0	0	0	0	0
Bicycles	0	0	0	0	0	0	0	5	0	0	10	0	15

	South	West	East	North	
Pedestrians	0	3	0	0	3





## Intersection Turning Movement Peak Hour Diagram

**Location** G STREET AT MAIN STREET  
**Date** 8/18/2005  
**Day of Week** Thursday  
**Time Begin** 16:00  
**Reviewed By:** BV

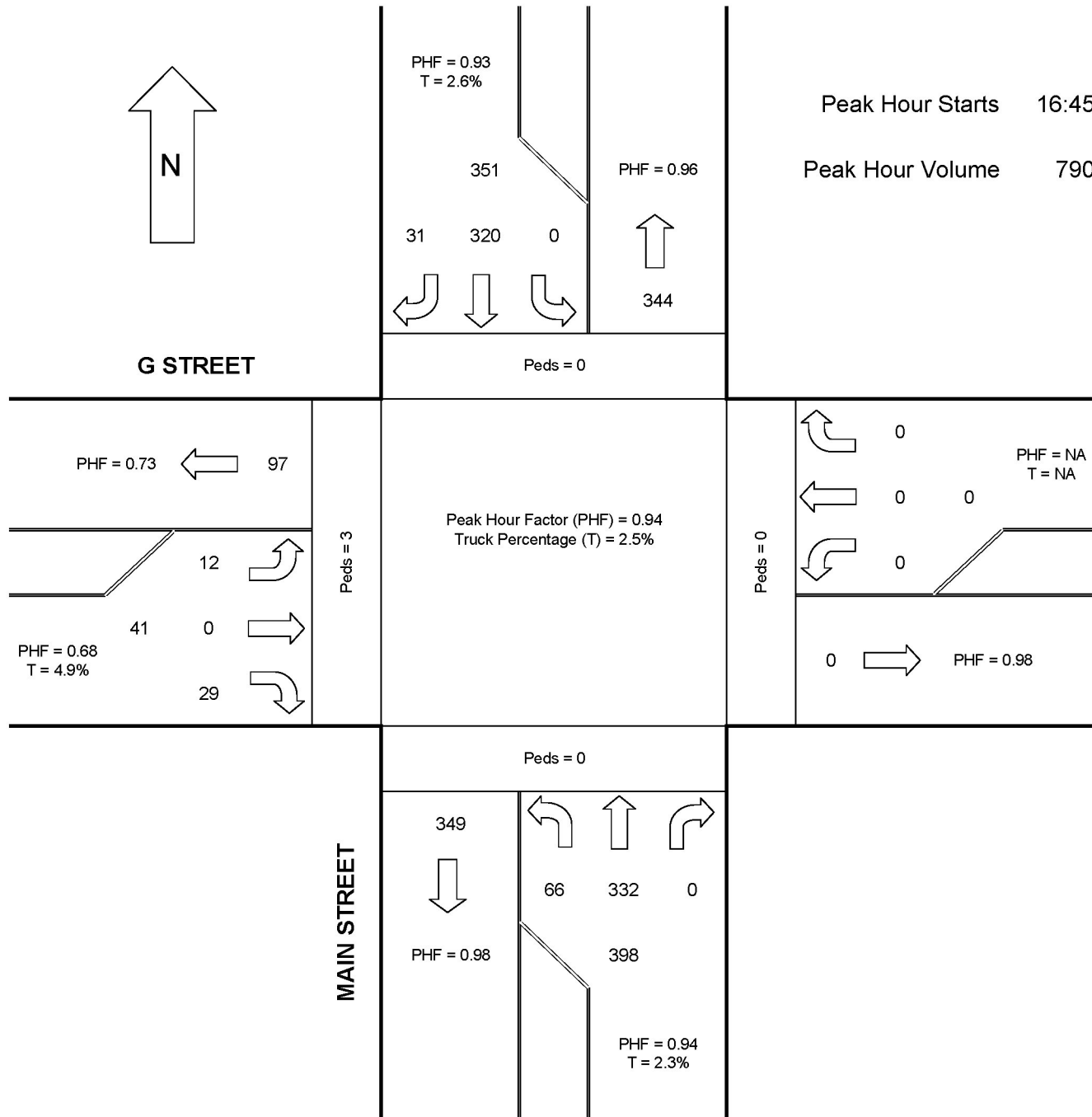

# Video Survey Field Sheet

TRAFSTATS PROJECT #

SURVEY DATE

05-202

8-18-05

LOCATION:

Main St and Monmouth

MAP PAGE

GRID

CITY:

Independence

TIME

4p-6p

WEATHER:  Sunny  Overcast  Rain  Snow  Fog

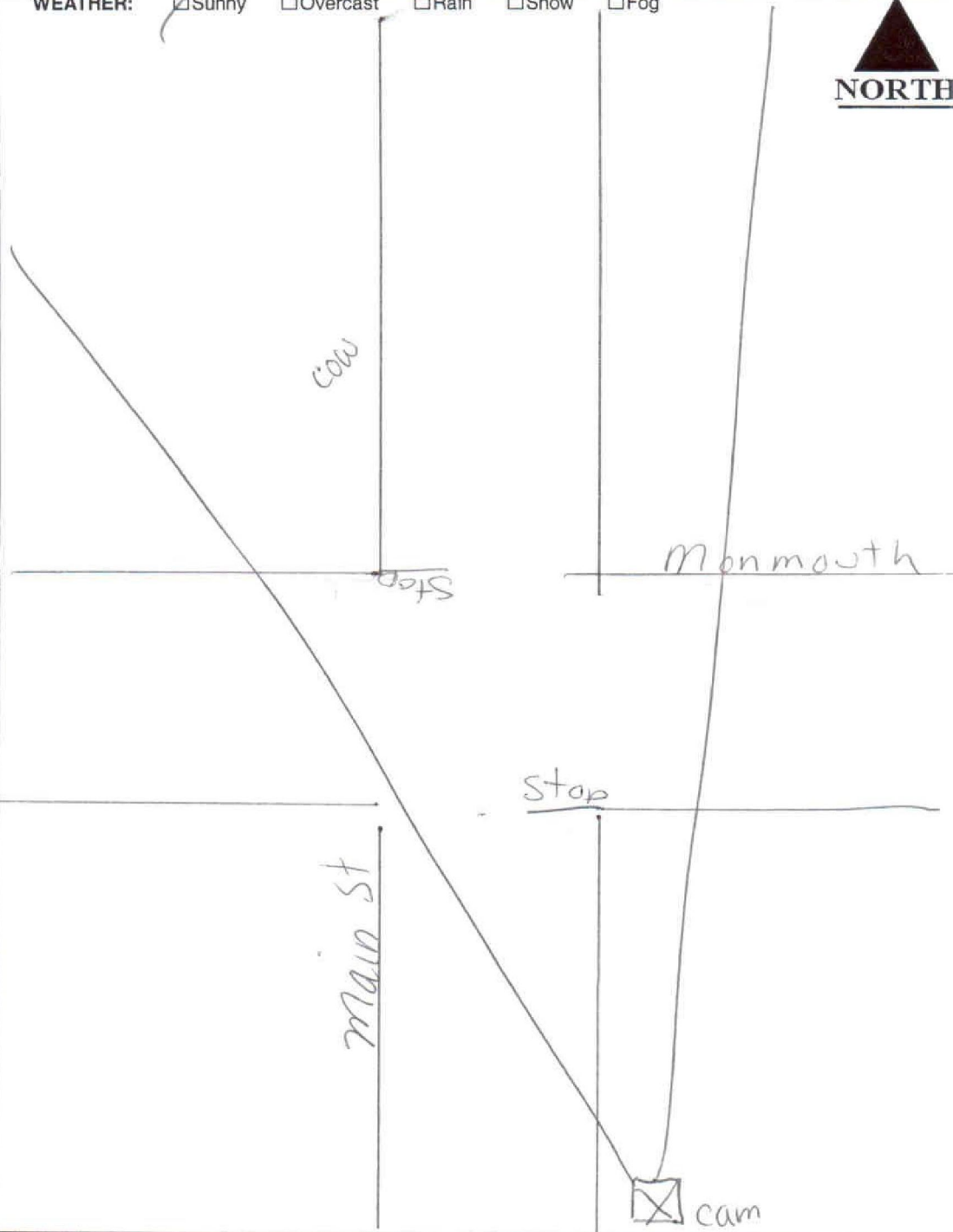

REMARKS:

Surveyed By:

DH / NA



1225 SW Murray Rd Suite 110  
Portland, OR 97229

## CAMERA - A | R

Number	C04
Start 1st Film	Date: 8-18-05
	Time: 2:24p
	Film: T26
	Batt: B17
Start 2nd Film	Date:
	Time:
	Film:
	Batt:
Start 3rd Film	Date:
	Time:
	Film:
	Batt:
Start 4th Film	Date:
	Time:
	Film:
	Batt:
Start 5th Film	Date:
	Time:
	Film:
	Batt:

## CAMERA - B | R

Number	
Start 1st Film	Date:
	Time:
	Film:
	Batt:
Start 2nd Film	Date:
	Time:
	Film:
	Batt:
Start 3rd Film	Date:
	Time:
	Film:
	Batt:
Start 4th Film	Date:
	Time:
	Film:
	Batt:
Start 5th Film	Date:
	Time:
	Film:
	Batt:



## Intersection Turning Movement Summary Report

**Location** MONMOUTH STREET AT MAIN STREET  
**Date** 8/18/2005  
**Day of Week** Thursday  
**Time Begin** 16:00  
**Reviewed By:** JW

Time Period	Eastbound			Westbound			Northbound			Southbound			Totals
	Right	Thru	Left	Right	Thru	Left	Right	Thru	Left	Right	Thru	Left	
16:00 - 16:15	43	0	41	0	1	0	0	22	38	27	27	0	199
16:15 - 16:30	34	0	39	0	1	0	0	32	41	43	37	0	227
16:30 - 16:45	30	0	38	0	0	0	0	34	49	36	41	0	228
16:45 - 17:00	36	0	47	0	0	0	0	45	45	38	37	0	248
17:00 - 17:15	48	0	45	0	0	0	0	31	49	43	39	0	255
17:15 - 17:30	42	0	38	0	0	0	0	41	45	55	49	0	270
17:30 - 17:45	42	0	40	0	0	0	0	44	41	59	38	0	264
17:45 - 18:00	39	0	46	0	0	0	0	37	40	32	42	0	236
<b>Movement Totals</b>	<b>314</b>	<b>0</b>	<b>334</b>	<b>0</b>	<b>2</b>	<b>0</b>	<b>0</b>	<b>286</b>	<b>348</b>	<b>333</b>	<b>310</b>	<b>0</b>	<b>1927</b>
Enter Totals	648			2			634			643			
Exit Totals	0			683			620			624			

**Two-Hour Totals**

Light Trucks	2	0	9	0	0	0	0	7	3	8	6	0	35
Medium Trucks	0	0	1	0	0	0	0	13	0	0	12	0	26
Heavy Trucks	0	0	2	0	0	0	0	3	1	1	3	0	10
% Trucks	0.6%	NA	3.6%	NA	0.0%	NA	NA	8.0%	1.1%	2.7%	6.8%	NA	3.7%
Buses	0	0	0	0	0	0	0	0	0	0	0	0	0
Bicycles	0	0	0	0	0	0	0	0	0	0	0	0	0

	South	West	East	North	
Pedestrians	15	32	0	18	65

### Peak Hour Information

**Peak Hour 16:45 17:45**

	Eastbound			Westbound			Northbound			Southbound			Totals
	Right	Thru	Left	Right	Thru	Left	Right	Thru	Left	Right	Thru	Left	
Movement Total	168	0	170	0	0	0	0	161	180	195	163	0	1037
Peak Hour Factor	0.88	NA	0.90	NA	NA	NA	NA	0.89	0.92	0.83	0.83	NA	0.96
Enter Totals	338			358			341			0			
Peak Hour Factor	0.91			0.86			0.95			NA			
Exit Totals	0			331			331			375			
Peak Hour Factor	NA			0.91			0.90			0.94			
Light Trucks	1	0	5	0	0	0	0	4	2	3	1	0	16
Medium Trucks	0	0	0	0	0	0	0	5	0	0	5	0	10
Heavy Trucks	0	0	2	0	0	0	0	2	0	1	1	0	6
% Trucks	0.6%	NA	4.1%	NA	NA	NA	NA	6.8%	1.1%	2.1%	4.3%	NA	3.1%
Buses	0	0	0	0	0	0	0	0	0	0	0	0	0
Bicycles	0	0	0	0	0	0	0	0	0	0	0	0	0

	South	West	East	North	
Pedestrians	6	22	0	5	33



## Intersection Turning Movement Peak Hour Diagram

**Location** MONMOUTH STREET AT MAIN STREET  
**Date** 8/18/2005  
**Day of Week** Thursday  
**Time Begin** 16:00  
**Reviewed By:** JW

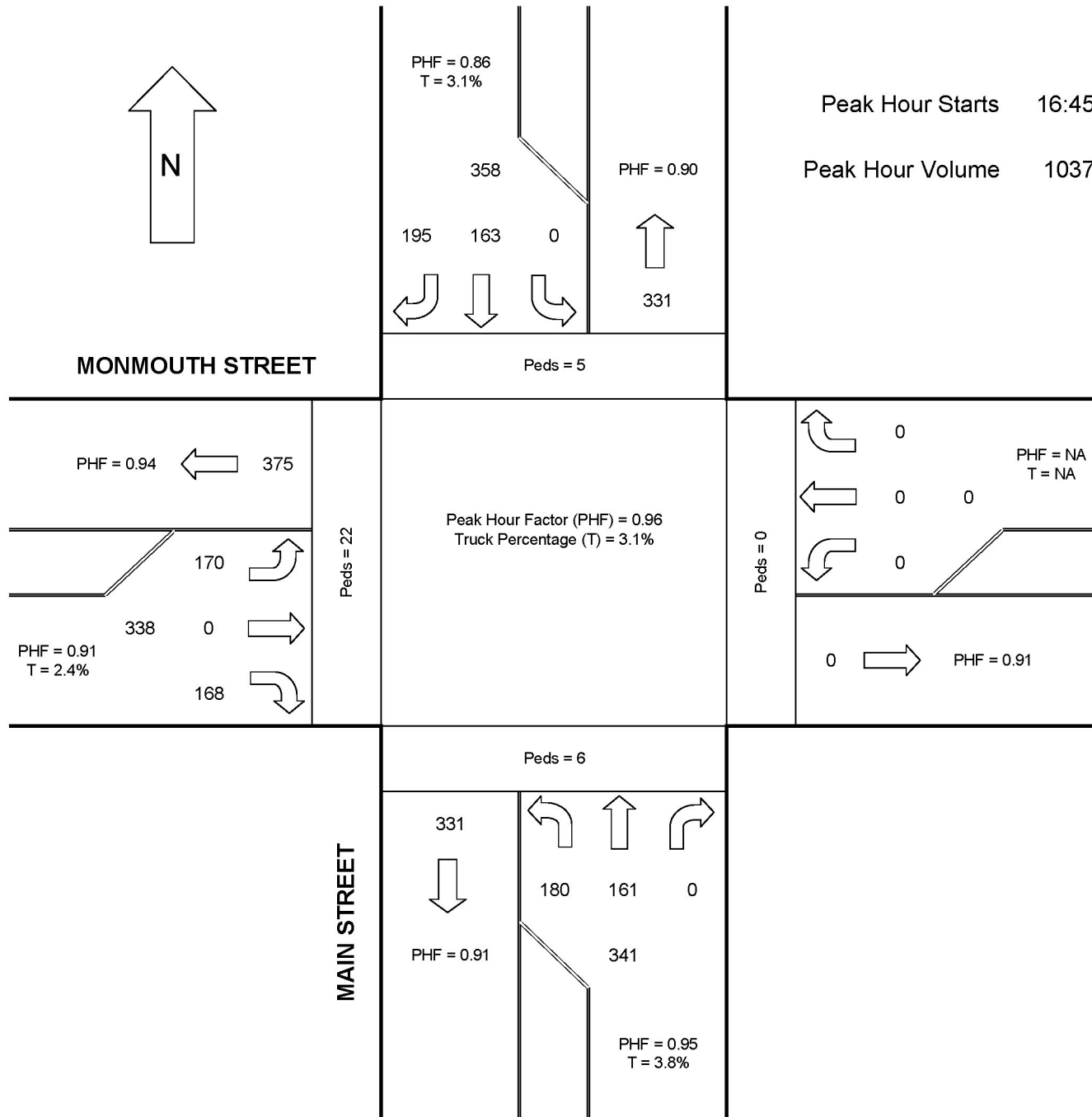

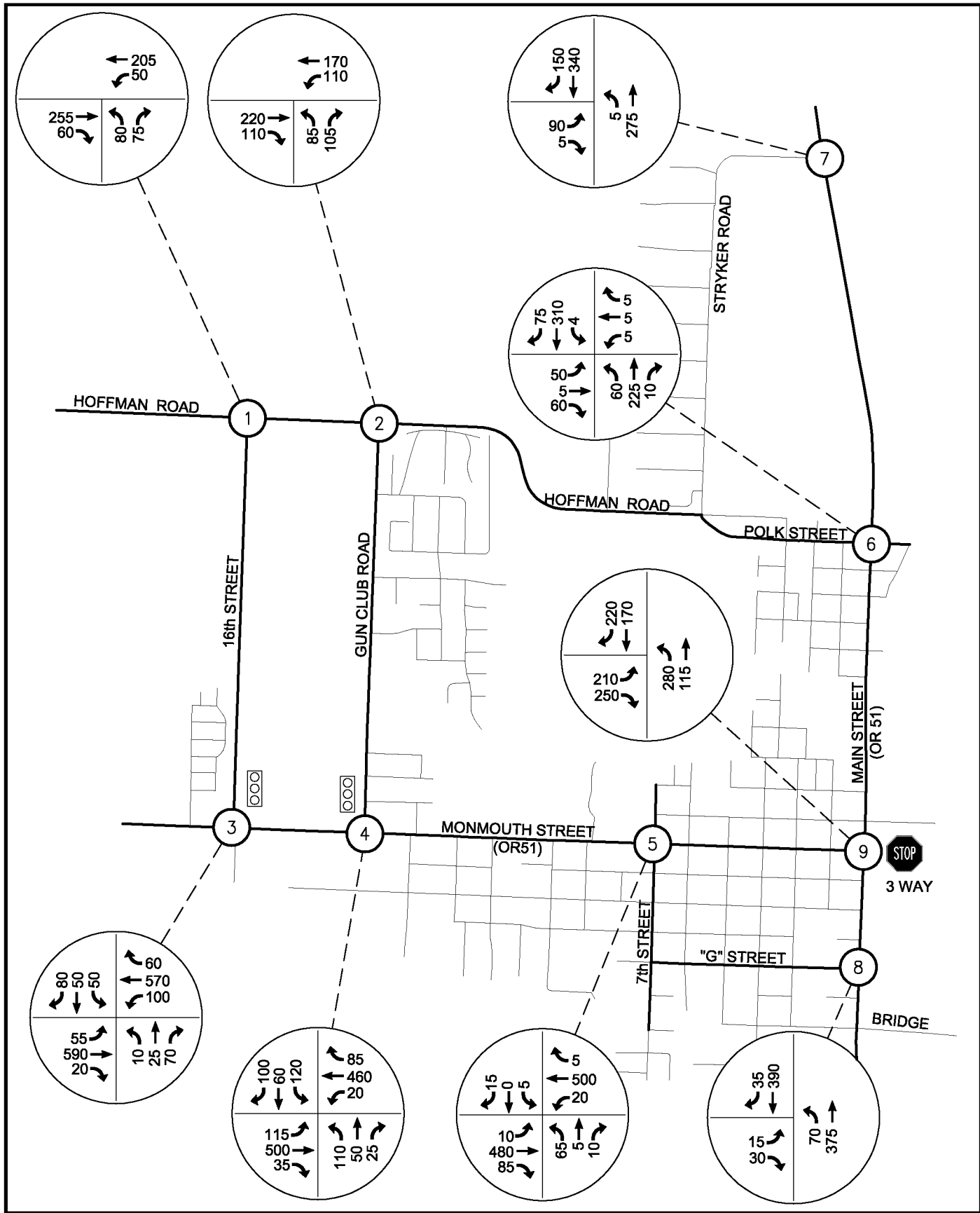

Parametrix DATE: Apr 04, 2007 FILE: PO2385051P05F-02























**LEGEND**

↪ 105 TURNING MOVEMENT BY DIRECTION OF TRAFFIC

**Figure 5**  
**2006 Balanced Traffic Volumes**





















INDEPENDENCE, OREGON

1: Hwy 51 & 16th Street

												
Movement	EBL	EBT	EBR	WBL	WBT	WBR	NBL	NBT	NBR	SBL	SBT	SBR
Lane Configurations												
Ideal Flow (vphpl)	1800	1800	1800	1800	1800	1800	1800	1800	1800	1800	1800	1800
Total Lost time (s)	4.0	4.0		4.0	4.0		4.0	4.0		4.0	4.0	
Lane Util. Factor	1.00	1.00		1.00	1.00		1.00	1.00		1.00	1.00	
Frt	1.00	0.99		1.00	0.99		1.00	0.89		1.00	0.91	
Flt Protected	0.95	1.00		0.95	1.00		0.95	1.00		0.95	1.00	
Satd. Flow (prot)	1676	1756		1676	1742		1676	1567		1676	1598	
Flt Permitted	0.95	1.00		0.95	1.00		0.69	1.00		0.70	1.00	
Satd. Flow (perm)	1676	1756		1676	1742		1210	1567		1236	1598	
Volume (vph)	50	565	20	90	525	50	10	20	60	35	35	60
Peak-hour factor, PHF	0.92	0.92	0.92	0.92	0.92	0.92	0.92	0.92	0.92	0.92	0.92	0.92
Adj. Flow (vph)	54	614	22	98	571	54	11	22	65	38	38	65
RTOR Reduction (vph)	0	1	0	0	3	0	0	47	0	0	47	0
Lane Group Flow (vph)	54	635	0	98	622	0	11	40	0	38	56	0
Turn Type	Prot		Prot		Perm		Perm		Perm		Perm	
Protected Phases	5	2		1	6			8				4
Permitted Phases							8				4	
Actuated Green, G (s)	17.0	40.0		17.0	40.0		26.0	26.0		26.0	26.0	
Effective Green, g (s)	17.0	40.0		17.0	40.0		26.0	26.0		26.0	26.0	
Actuated g/C Ratio	0.18	0.42		0.18	0.42		0.27	0.27		0.27	0.27	
Clearance Time (s)	4.0	4.0		4.0	4.0		4.0	4.0		4.0	4.0	
Lane Grp Cap (vph)	300	739		300	733		331	429		338	437	
v/s Ratio Prot	0.03	c0.36		c0.06	0.36			0.06			c0.06	
v/s Ratio Perm							0.01			0.03		
v/c Ratio	0.18	0.86		0.33	0.85		0.03	0.09		0.11	0.13	
Uniform Delay, d1	33.1	24.9		34.0	24.8		25.3	25.7		25.9	26.0	
Progression Factor	1.00	1.00		0.79	1.32		1.00	1.00		1.00	1.00	
Incremental Delay, d2	1.3	12.4		2.0	8.5		0.2	0.4		0.7	0.6	
Delay (s)	34.4	37.4		28.8	41.3		25.5	26.1		26.5	26.6	
Level of Service	C	D		C	D		C	C		C	C	
Approach Delay (s)		37.1			39.6			26.1			26.6	
Approach LOS		D			D			C			C	
<b>Intersection Summary</b>												
HCM Average Control Delay			36.7			HCM Level of Service					D	
HCM Volume to Capacity ratio			0.56									
Actuated Cycle Length (s)			95.0			Sum of lost time (s)				12.0		
Intersection Capacity Utilization			56.6%			ICU Level of Service					B	
Analysis Period (min)			15									









c Critical Lane Group

2: Hwy 51 & Gun Club Road

												
Movement	EBL	EBT	EBR	WBL	WBT	WBR	NBL	NBT	NBR	SBL	SBT	SBR
Lane Configurations												
Ideal Flow (vphpl)	1800	1800	1800	1800	1800	1800	1800	1800	1800	1800	1800	1800
Total Lost time (s)	4.0	4.0		4.0	4.0		4.0	4.0			4.0	
Lane Util. Factor	1.00	1.00		1.00	1.00		1.00	1.00			1.00	
Frt	1.00	0.99		1.00	0.98		1.00	0.94			0.96	
Flt Protected	0.95	1.00		0.95	1.00		0.95	1.00			0.98	
Satd. Flow (prot)	1676	1749		1676	1723		1676	1664			1653	
Flt Permitted	0.95	1.00		0.95	1.00		0.53	1.00			0.81	
Satd. Flow (perm)	1676	1749		1676	1723		940	1664			1370	
Volume (vph)	105	475	30	20	450	85	110	50	30	120	60	80
Peak-hour factor, PHF	0.92	0.92	0.92	0.92	0.92	0.92	0.92	0.92	0.92	0.92	0.92	0.92
Adj. Flow (vph)	114	516	33	22	489	92	120	54	33	130	65	87
RTOR Reduction (vph)	0	2	0	0	7	0	0	23	0	0	17	0
Lane Group Flow (vph)	114	547	0	22	574	0	120	64	0	0	265	0
Turn Type	Prot		Prot		Perm		Perm		Perm		Perm	
Protected Phases	5	2		1	6			8				4
Permitted Phases							8				4	
Actuated Green, G (s)	17.0	40.0		17.0	40.0		26.0	26.0			26.0	
Effective Green, g (s)	17.0	40.0		17.0	40.0		26.0	26.0			26.0	
Actuated g/C Ratio	0.18	0.42		0.18	0.42		0.27	0.27			0.27	
Clearance Time (s)	4.0	4.0		4.0	4.0		4.0	4.0			4.0	
Lane Grp Cap (vph)	300	736		300	725		257	455			375	
v/s Ratio Prot	c0.07	0.31		0.01	c0.34			0.05				
v/s Ratio Perm							0.13				c0.21	
v/c Ratio	0.38	0.74		0.07	0.79		0.47	0.14			0.71	
Uniform Delay, d1	34.4	23.2		32.4	23.9		28.7	26.1			31.1	
Progression Factor	1.18	0.74		1.00	1.00		1.00	1.00			1.00	
Incremental Delay, d2	2.3	4.3		0.5	8.6		6.0	0.6			10.7	
Delay (s)	43.0	21.4		32.9	32.5		34.7	26.7			41.8	
Level of Service	D	C		C	C		C	C			D	
Approach Delay (s)		25.1			32.5			31.3			41.8	
Approach LOS		C			C			C			D	
<b>Intersection Summary</b>												
HCM Average Control Delay			31.1			HCM Level of Service					C	
HCM Volume to Capacity ratio			0.70									
Actuated Cycle Length (s)			95.0			Sum of lost time (s)				12.0		
Intersection Capacity Utilization			68.8%			ICU Level of Service					C	
Analysis Period (min)			15									













c Critical Lane Group

4: Hwy 51 & Main Street

						
Movement	EBL	EBR	NBL	NBT	SBT	SBR
Lane Configurations						
Sign Control	Stop			Stop	Stop	
Volume (vph)	200	255	300	180	195	240
Peak Hour Factor	0.92	0.92	0.92	0.92	0.92	0.92
Hourly flow rate (vph)	217	277	326	196	212	261
Direction, Lane #	EB 1	NB 1	SB 1			
Volume Total (vph)	495	522	473			
Volume Left (vph)	217	326	0			
Volume Right (vph)	277	0	261			
Hadj (s)	-0.2	0.2	-0.3			
Departure Headway (s)	6.3	6.5	6.2			
Degree Utilization, x	0.87	0.94	0.81			
Capacity (veh/h)	555	545	567			
Control Delay (s)	16.5	19.9	14.6			
Approach Delay (s)	16.5	19.9	14.6			
Approach LOS	C	C	B			
Intersection Summary						
Delay			17.1			
HCM Level of Service			C			
Intersection Capacity Utilization			92.1%	ICU Level of Service	F	
Analysis Period (min)			15			



5: Polk Street & Main Street

												
Movement	EBL	EBT	EBR	WBL	WBT	WBR	NBL	NBT	NBR	SBL	SBT	SBR
Lane Configurations		↕			↕			↕			↕	
Sign Control		Stop			Stop			Free			Free	
Grade		0%			0%			0%			0%	
Volume (veh/h)	60	5	80	5	5	5	65	250	15	5	300	75
Peak Hour Factor	0.92	0.92	0.92	0.92	0.92	0.92	0.92	0.92	0.92	0.92	0.92	0.92
Hourly flow rate (vph)	65	5	87	5	5	5	71	272	16	5	326	82
Pedestrians												
Lane Width (ft)												
Walking Speed (ft/s)												
Percent Blockage												
Right turn flare (veh)												
Median type		None			None							
Median storage (veh)												
Upstream signal (ft)												
pX, platoon unblocked												
vC, conflicting volume	807	807	367	889	840	280	408			288		
vC1, stage 1 conf vol												
vC2, stage 2 conf vol												
vCu, unblocked vol	807	807	367	889	840	280	408			288		
tC, single (s)	7.1	6.5	6.2	7.1	6.5	6.2	4.1			4.1		
tC, 2 stage (s)												
tF (s)	3.5	4.0	3.3	3.5	4.0	3.3	2.2			2.2		
p0 queue free %	77	98	87	97	98	99	94			100		
cM capacity (veh/h)	279	295	678	216	282	759	1151			1274		
<b>Direction, Lane #</b>	<b>EB 1</b>	<b>WB 1</b>	<b>NB 1</b>	<b>SB 1</b>								
Volume Total	158	16	359	413								
Volume Left	65	5	71	5								
Volume Right	87	5	16	82								
cSH	414	316	1151	1274								
Volume to Capacity	0.38	0.05	0.06	0.00								
Queue Length (ft)	44	4	5	0								
Control Delay (s)	18.9	17.0	2.1	0.1								
Lane LOS	C	C	A	A								
Approach Delay (s)	18.9	17.0	2.1	0.1								
Approach LOS	C	C										
<b>Intersection Summary</b>												
Average Delay			4.3									
Intersection Capacity Utilization			63.3%		ICU Level of Service					B		
Analysis Period (min)			15									

6: Stryker Road & Main Street

Movement	EBL	EBR	NBL	NBT	SBT	SBR
Lane Configurations						
Sign Control	Stop			Free	Free	
Grade	0%			0%	0%	
Volume (veh/h)	90	5	5	300	325	150
Peak Hour Factor	0.92	0.92	0.92	0.92	0.92	0.92
Hourly flow rate (vph)	98	5	5	326	353	163
Pedestrians						
Lane Width (ft)						
Walking Speed (ft/s)						
Percent Blockage						
Right turn flare (veh)						
Median type	None					
Median storage veh						
Upstream signal (ft)						
pX, platoon unblocked						
vC, conflicting volume	772	435	516			
vC1, stage 1 conf vol						
vC2, stage 2 conf vol						
vCu, unblocked vol	772	435	516			
tC, single (s)	6.4	6.2	4.1			
tC, 2 stage (s)						
tF (s)	3.5	3.3	2.2			
p0 queue free %	73	99	99			
cM capacity (veh/h)	366	621	1049			
Direction, Lane #	EB 1	NB 1	NB 2	SB 1		
Volume Total	103	5	326	516		
Volume Left	98	5	0	0		
Volume Right	5	0	0	163		
cSH	374	1049	1700	1700		
Volume to Capacity	0.28	0.01	0.19	0.30		
Queue Length (ft)	28	0	0	0		
Control Delay (s)	18.2	8.4	0.0	0.0		
Lane LOS	C	A				
Approach Delay (s)	18.2	0.1		0.0		
Approach LOS	C					
Intersection Summary						
Average Delay			2.0			
Intersection Capacity Utilization		40.0%		ICU Level of Service		A
Analysis Period (min)			15			



8: Hoffman Road & 16th Street

Movement	EBT	EBR	WBL	WBT	NBL	NBR
Lane Configurations	↔			↔	↔	↔
Sign Control	Free			Free	Stop	
Grade	0%			0%	0%	
Volume (veh/h)	225	60	50	220	40	50
Peak Hour Factor	0.92	0.92	0.92	0.92	0.92	0.92
Hourly flow rate (vph)	245	65	54	239	43	54
Pedestrians						
Lane Width (ft)						
Walking Speed (ft/s)						
Percent Blockage						
Right turn flare (veh)						
Median type	None					
Median storage veh						
Upstream signal (ft)						
pX, platoon unblocked						
vC, conflicting volume			310		625	277
vC1, stage 1 conf vol						
vC2, stage 2 conf vol						
vCu, unblocked vol			310		625	277
tC, single (s)			4.1		6.4	6.2
tC, 2 stage (s)						
tF (s)			2.2		3.5	3.3
p0 queue free %			96		90	93
cM capacity (veh/h)			1251		429	762
<b>Direction, Lane #</b>	<b>EB 1</b>	<b>WB 1</b>	<b>NB 1</b>	<b>NB 2</b>		
Volume Total	310	293	43	54		
Volume Left	0	54	43	0		
Volume Right	65	0	0	54		
cSH	1700	1251	429	762		
Volume to Capacity	0.18	0.04	0.10	0.07		
Queue Length 95th (ft)	0	3	8	6		
Control Delay (s)	0.0	1.8	14.3	10.1		
Lane LOS		A	B	B		
Approach Delay (s)	0.0	1.8	12.0			
Approach LOS			B			
<b>Intersection Summary</b>						
Average Delay			2.4			
Intersection Capacity Utilization			44.8%	ICU Level of Service	A	
Analysis Period (min)			15			













9: Hoffman Road & Gun Club Road

Movement	EBT	EBR	WBL	WBT	NBL	NBR
Lane Configurations	↔			↔		↔
Sign Control	Free			Free	Stop	
Grade	0%			0%	0%	
Volume (veh/h)	175	100	105	190	80	70
Peak Hour Factor	0.92	0.92	0.92	0.92	0.92	0.92
Hourly flow rate (vph)	190	109	114	207	87	76
Pedestrians						
Lane Width (ft)						
Walking Speed (ft/s)						
Percent Blockage						
Right turn flare (veh)						
Median type	None					
Median storage veh						
Upstream signal (ft)						
pX, platoon unblocked						
vC, conflicting volume			299		679	245
vC1, stage 1 conf vol						
vC2, stage 2 conf vol						
vCu, unblocked vol			299		679	245
tC, single (s)			4.1		6.4	6.2
tC, 2 stage (s)						
tF (s)			2.2		3.5	3.3
p0 queue free %			91		77	90
cM capacity (veh/h)			1262		379	794
<b>Direction, Lane #</b>	<b>EB 1</b>	<b>WB 1</b>	<b>NB 1</b>			
Volume Total	299	321	163			
Volume Left	0	114	87			
Volume Right	109	0	76			
cSH	1700	1262	502			
Volume to Capacity	0.18	0.09	0.33			
Queue Length (ft)	0	7	35			
Control Delay (s)	0.0	3.4	15.6			
Lane LOS		A	C			
Approach Delay (s)	0.0	3.4	15.6			
Approach LOS			C			
<b>Intersection Summary</b>						
Average Delay			4.7			
Intersection Capacity Utilization			52.1%	ICU Level of Service	A	
Analysis Period (min)			15			

14: 'G' Street & Main Street

Movement	EBL	EBR	NBL	NBT	SBT	SBR
Lane Configurations						
Sign Control	Stop		Free		Free	
Grade	0%		0%		0%	
Volume (veh/h)	45	70	75	435	405	45
Peak Hour Factor	0.92	0.92	0.92	0.92	0.92	0.92
Hourly flow rate (vph)	49	76	82	473	440	49
Pedestrians						
Lane Width (ft)						
Walking Speed (ft/s)						
Percent Blockage						
Right turn flare (veh)						
Median type	None					
Median storage veh						
Upstream signal (ft)						
pX, platoon unblocked						
vC, conflicting volume	1101	465	489			
vC1, stage 1 conf vol						
vC2, stage 2 conf vol						
vCu, unblocked vol	1101	465	489			
tC, single (s)	6.4	6.2	4.1			
tC, 2 stage (s)						
tF (s)	3.5	3.3	2.2			
p0 queue free %	77	87	92			
cM capacity (veh/h)	217	598	1074			
<b>Direction, Lane #</b>	<b>EB 1</b>	<b>NB 1</b>	<b>SB 1</b>			
Volume Total	125	554	489			
Volume Left	49	82	0			
Volume Right	76	0	49			
cSH	354	1074	1700			
Volume to Capacity	0.35	0.08	0.29			
Queue Length (ft)	39	6	0			
Control Delay (s)	20.6	2.0	0.0			
Lane LOS	C	A				
Approach Delay (s)	20.6	2.0	0.0			
Approach LOS	C					
<b>Intersection Summary</b>						
Average Delay			3.2			
Intersection Capacity Utilization			71.1%	ICU Level of Service	C	
Analysis Period (min)			15			

15: Hwy 51 & 7th Street

												
Movement	EBL	EBT	EBR	WBL	WBT	WBR	NBL	NBT	NBR	SBL	SBT	SBR
Lane Configurations		↕			↕			↕			↕	
Sign Control		Free			Free			Stop			Stop	
Grade		0%			0%			0%			0%	
Volume (veh/h)	10	470	85	20	525	5	65	5	10	5	0	15
Peak Hour Factor	0.92	0.92	0.92	0.92	0.92	0.92	0.92	0.92	0.92	0.92	0.92	0.92
Hourly flow rate (vph)	11	511	92	22	571	5	71	5	11	5	0	16
Pedestrians												
Lane Width (ft)												
Walking Speed (ft/s)												
Percent Blockage												
Right turn flare (veh)												
Median type							None			None		
Median storage veh												
Upstream signal (ft)												
pX, platoon unblocked												
vC, conflicting volume	576			603			1212	1198	557	1209	1242	573
vC1, stage 1 conf vol												
vC2, stage 2 conf vol												
vCu, unblocked vol	576			603			1212	1198	557	1209	1242	573
tC, single (s)	4.1			4.1			7.1	6.5	6.2	7.1	6.5	6.2
tC, 2 stage (s)												
tF (s)	2.2			2.2			3.5	4.0	3.3	3.5	4.0	3.3
p0 queue free %	99			98			53	97	98	96	100	97
cM capacity (veh/h)	997			974			150	179	530	149	169	519
<b>Direction, Lane #</b>	<b>EB 1</b>	<b>WB 1</b>	<b>NB 1</b>	<b>SB 1</b>								
Volume Total	614	598	87	22								
Volume Left	11	22	71	5								
Volume Right	92	5	11	16								
cSH	997	974	167	320								
Volume to Capacity	0.01	0.02	0.52	0.07								
Queue Length (ft)	1	2	65	5								
Control Delay (s)	0.3	0.6	48.0	17.1								
Lane LOS	A	A	E	C								
Approach Delay (s)	0.3	0.6	48.0	17.1								
Approach LOS				E	C							
<b>Intersection Summary</b>												
Average Delay				3.9								
Intersection Capacity Utilization				58.9%	ICU Level of Service	B						
Analysis Period (min)				15								

**APPENDIX SECTION B-4**

**Future Conditions Analysis**





**Traffic Analysis Methodology**

Count Data

ODOT provided 2006 count data for seven study intersections (Count Data: May 9-11th, 2006). A peak period was selected and was seasonally adjusted.

The City of Independence provided count data for the intersections of Main Street/Monmouth Street and Main Street/“G” Street (Count Data: August 18, 2005 for the PM peak hour). The count data was seasonally adjusted.

Adjustments

The closest Automatic Traffic Recorders (ATRs) were examined to help determine the characteristics for study area highways. The seasonal trend table was consulted to determine the count date seasonal factor and peak seasonal factor.

**2005 ATR Characteristics**

SEASONAL TRAFFIC TREND	AREA TYPE	# OF LANES	WEEKLY TRAFFIC TREND	2005 AADT	OHP CLASSIFICATION	ATR	COUNTY	HIGHWAY ROUTE, NAME & LOCATION	MP	STATE HWY #
COMMUTER	RURAL	2	WEEKDAY	7600	REGIONAL HIGHWAY	27-005	POLK	OR 99W, PACIFIC HWY WEST, SOUTH OF MONMOUTH	70.9	1W

**Oregon Highway 51(State Highway No. 43) Monmouth-Independence Hwy  
Commuter-Weekday was used to make seasonal adjustments**

Seasonal Factor Peak Period	0.9000		Adjustment Factor = Count Date Factor/ Seasonal Peak Period Factor
<b>Count Date Factor</b>			
<b>1-May</b>	0.9409	(0.9409+0.9366)/2	1.0431
<b>15-May</b>	0.9366		
<b>15 -Aug</b>	0.9000		1.0000

Historical trend methods based on data from ODOT 2025 Future Volume Tables. This is used to make adjustments to count data to bring it up to 2006 volumes as well as forecasting future growth for through traffic only.

ODOT Future Volume Table Data					
Hwy	Mp	2005	2025	RSQ	Annual Growth Rate
193	4.89	7900	9500	0.7955	0.0101
43	1.29	12300	16000	0.8263	0.0150
					0.0126

Average Annual Growth Rate

2026 volumes = 2006 Volumes x (1+(20x0.0126))= 2006 Volumes x 1.252

2042 volumes = 2006 Volumes x (1+(36x0.0126))= 2006 Volumes x 1.453

#### Volume Balancing

A print view from Synchro is provided that illustrates the volume that is added or subtracted between intersections based on the existing raw counts. Counts taken during the same day and time period provide the best information about what is happening along the roadway segments. In some cases these differences are greater than 10% of the adjacent road traffic. These differences were used for balancing and were maintained in all the alternatives.

#### Saturation Flow Rate

A saturation flow rate of 1800 pcphgl was used for both the existing and future year scenarios.

#### Signal Timing

ODOT provided signal timing for study area intersections was utilized in modeling for the 2006 condition. For future conditions for signalized intersections, an optimal system cycle length was determined with a 90 second minimum set.

#### Peak Hour Factors

PHF's are calculated using data from 15 minute interval traffic counts. The ODOT traffic counts do not contain 15 minute interval data, therefore a 0.92 PHF was used.

#### Peak hour selection

All the intersections counts should be adjusted to a single system peak hour which is the highest hourly volume. For our counts this was determined to be between 5 and 6 pm.

#### Forecasting Cumulative Analysis

The APM was followed in determining External-External (E-E), External-Internal (EI), Internal External (I-I), and Internal-Internal (I-I) trips.

The area within the City of Independence's Urban Growth Boundary (UGB) has been divided into 16 Traffic Analysis Zones (TAZs). An estimate of residential, commercial and industrial net buildable acreage within each TAZ was developed assuming full buildout of the UGB. To estimate buildable acreage for the year 2026, residential acreage assumptions were adjusted down to reflect official Independence population estimates. Parametrix used these two net buildable acreage estimates to generate the estimated growth in trips to and from each TAZ for the year 2026 and when full buildout of the UGB occurs.

Trip rates from the following ITE Trip Generation Categories were used:

- Industrial = Industrial Park (Code 130)
- Commercial = Shopping Center (Code 820)
- Low Density Residential = Single Family (Code 210)
- Medium Density Residential = Condominium/Townhouse (Code 230)
- High Density Residential = Apartment (Code 220)

External-External trips were determined using nodal stations north, south and west of the City. Volumes were held from Node 1 for eastbound/northbound/southbound traffic, Node 2 for southbound/westbound and Node 3 for northbound/westbound. The percentage of E-E trips were determined first, followed by the increase in E-I and I-E trips for each of the alternative's design years. See attached tables for more information.

The growth in trips were distributed to each of the TAZs based on attraction (entering) and production (exiting) calculations. Internal trips for each zone were determined by subtracting the E-I and I-E trips from the total trips for each zone. The data is summarized in the following tables. Once the trip distribution was determined, the zone trips were assigned to the road network based on knowledge of the network and engineering judgment. The volumes assigned to movements at each of the intersections was added to the 2006 balanced counts volume data. This total volume was evaluated to yield future intersection operations.

The Build Alternatives included a new arterial with significant impact traffic. For these alternatives the through trips and new growth trips from each zone were redistributed.

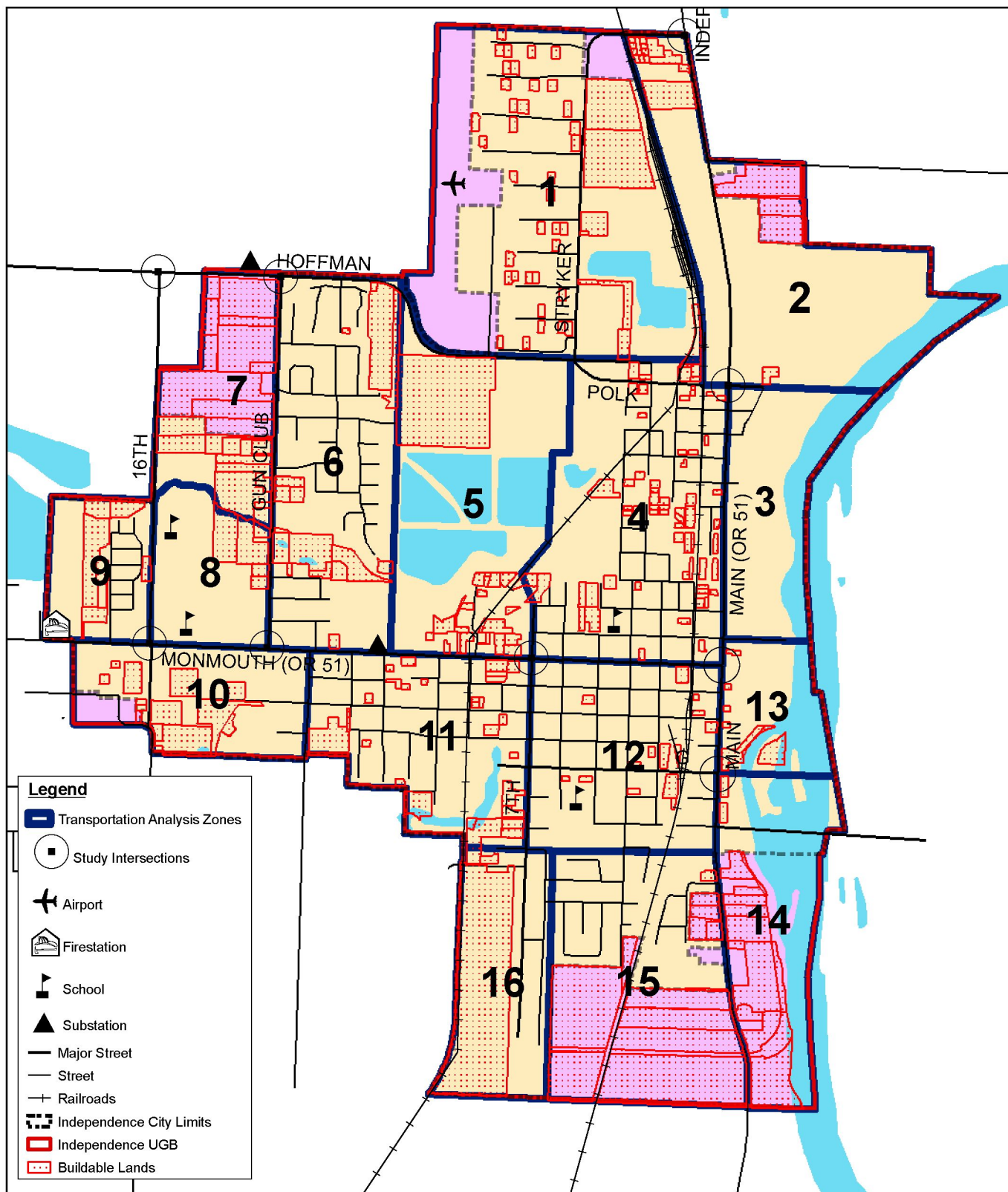

**Parametrix**



**Geographic Data Standards:**  
 Projected Coordinate System:  
 NAD 1983 HARN StatePlane Oregon North

**Data Source(s):**  
 Mid-Willamette Valley Council of Governments  
 Polk County GIS

Date: November 2006

*This product is for informational purposes and may not have been prepared for legal, engineering or surveying purposes. Users of this information should review or consult the primary data and information source to ascertain the usability of this information.*

**Figure 7  
 Traffic Analysis Zones**

INDEPENDENCE TSP

# DRAFT PROPOSED HWY. SEGMENT DESIGNATION INDEPENDENCE, OREGON

Revised: December 8, 2003

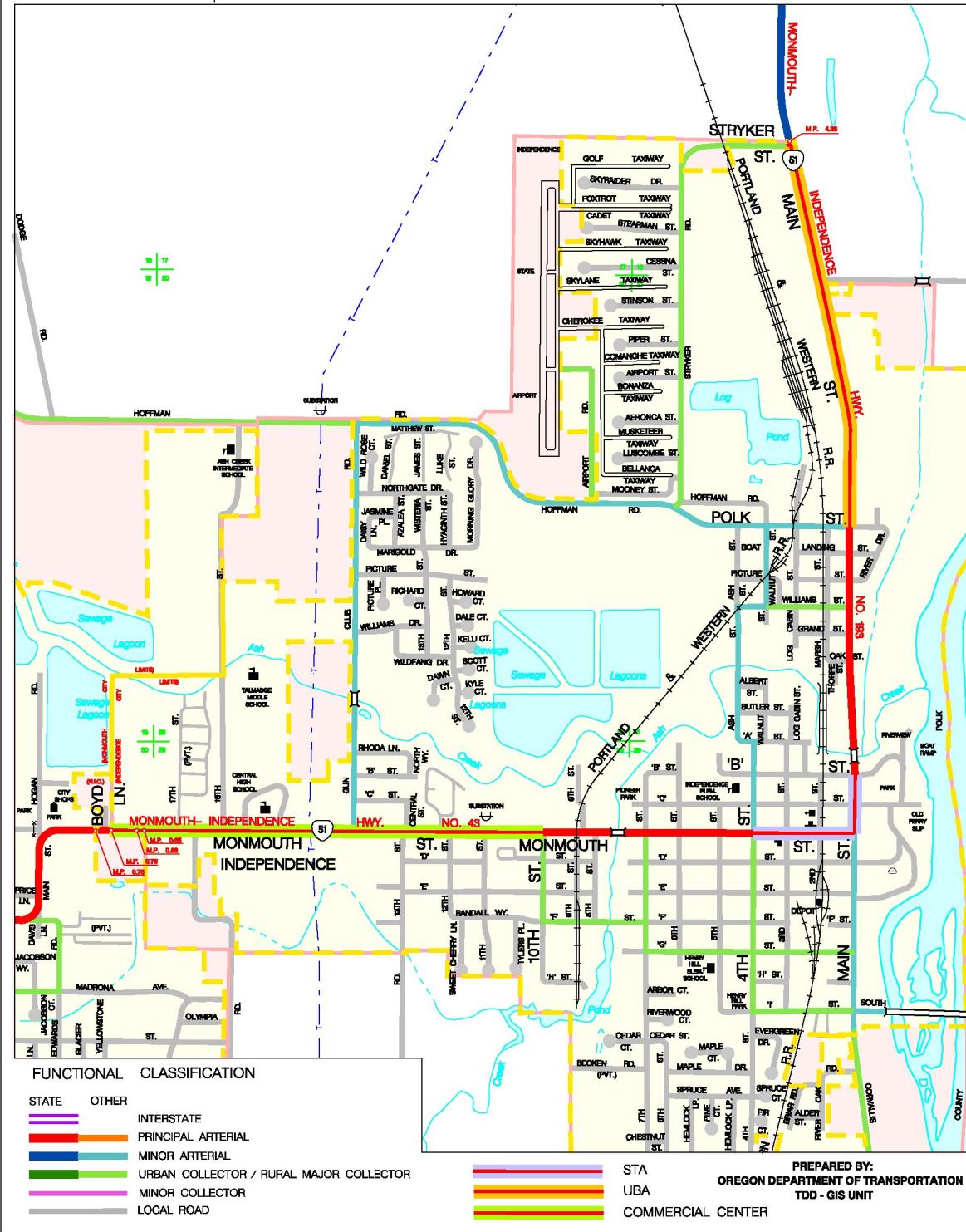
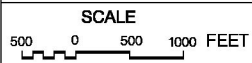

**Full UGB Build-out 2042**  
External Trip Table

	Direction	2006 DHV	2006 E-E Probability	E-E Trip Probability	Growth Factor 2042	2042 DHV	2042 E-E trip	2042 E-I trip
<b>Node 1</b>	Enter	635	300	0.47	1.45288	925	135	155
	West Exit	585	190	0.32	1.45288	865	85	185
<b>Node 2</b>	Enter	475	190	0.40	1.45288	690	85	130
	North Exit	390	235	0.60	1.45288	565	105	70
<b>Node 3</b>	Enter	510	235	0.46	1.45288	740	105	125
	South Exit	475	300	0.63	1.45288	690	135	80

**Trip Attraction and Production Probabilities**

	1	2	3	4	5	6	7	8	9	10	11	12	13	14	15	16 Total
Total New Trips	233	105	0	159	260	111	362	56	83	406	136	117	71	229	537	265 3130
Entering Trips	78	64	0	84	83	71	228	36	54	210	75	54	29	131	338	167 1702
Attraction Probability	0.046	0.038	0.000	0.049	0.049	0.042	0.184	0.021	0.032	0.123	0.044	0.032	0.017	0.077	0.199	0.098
Exiting Trips	155	41	0	75	177	40	134	21	29	195	58	63	42	98	199	98 1425
Production Probability	0.109	0.029	0.000	0.053	0.124	0.028	0.094	0.015	0.020	0.137	0.041	0.044	0.029	0.069	0.140	0.069

**External-Internal Trip Distribution**

Zone	1	2	3	4	5	6	7	8	9	10	11	12	13	14	15	16 Total
Node 1	7	6	0	8	8	6	21	3	5	19	7	5	3	12	31	15 155
Node 2	6	5	0	6	6	5	17	3	4	16	6	4	2	10	26	13 130
Node 3	6	5	0	6	6	5	17	3	4	15	6	4	2	10	25	12 125

**Internal-External Trip Distribution**

Zone	1	2	3	4	5	6	7	8	9	10	11	12	13	14	15	16 Total
Node 1	20	5	0	10	23	5	17	3	4	25	8	8	5	13	26	13 185
Node 2	8	2	0	4	9	2	7	1	1	10	3	3	2	5	10	5 70
Node 3	9	2	0	4	10	2	8	1	2	11	3	4	2	6	11	6 80

**Internal-Internal Trip**

Zone	1	2	3	4	5	6	7	8	9	10	11	12	13	14	15	16 Total
Total New Trips	233	105	0	159	260	111	362	56	83	406	136	117	71	229	537	265
Total Internal-Internal Trip	178	80	0	121	198	84	276	42	63	310	104	89	54	174	409	202
Entering Trips	71	58	0	76	75	65	207	33	49	191	68	49	26	119	307	152 1547
Attraction Probability	0.046	0.038	0.000	0.049	0.049	0.042	0.184	0.021	0.032	0.123	0.044	0.032	0.017	0.077	0.199	0.098
Exiting Trips	135	36	0	65	154	35	117	18	25	170	50	55	37	85	173	85 1240
Production Probability	0.109	0.029	0.000	0.053	0.124	0.028	0.094	0.015	0.020	0.137	0.041	0.044	0.029	0.069	0.140	0.069

**Full UGB Build-out 2042**

Zone	1	2	3	4	5	6	7	8	9	10	11	12	13	14	15	16
<b>Internal Distribution</b>																
Attractions	71	58	0	76	75	65	207	33	49	191	68	49	26	119	307	152
1	0.046	3	0	3	3	3	9	1	2	7	3	2	1	5	14	7
2	0.038	3	0	3	3	2	8	1	2	7	3	2	1	4	12	6
3	0.000	0	0	0	0	0	0	0	0	0	0	0	0	0	0	0
4	0.049	3	0	4	4	3	10	2	2	9	3	2	1	6	15	7
5	0.049	3	0	4	4	3	10	2	2	9	3	2	1	6	15	7
6	0.042	3	0	3	3	3	9	1	2	8	3	2	1	5	13	6
7	0.134	9	8	10	10	9	28	4	7	26	9	7	4	16	41	20
8	0.021	1	1	2	2	1	4	1	1	4	1	1	1	3	6	3
9	0.032	2	2	2	2	2	7	1	2	6	2	2	1	4	10	5
10	0.123	9	7	9	9	8	26	4	6	24	8	6	3	15	38	19
11	0.044	3	3	3	3	3	9	1	2	8	3	2	1	5	14	7
12	0.032	2	2	2	2	2	7	1	2	6	2	2	1	4	10	5
13	0.017	1	1	1	1	1	4	1	1	3	1	1	0	2	5	3
14	0.077	5	4	6	6	5	16	3	4	15	5	4	2	9	24	12
15	0.199	14	12	15	15	13	41	6	10	38	14	10	5	24	61	30
16	0.098	7	6	7	7	6	20	3	5	19	7	5	3	12	30	15
<b>Production</b>																
1	0.109	36	0	65	154	35	117	18	25	170	50	55	37	85	173	85
2	0.029	4	0	7	17	4	13	2	3	18	5	6	4	9	19	9
3	0.000	0	0	2	4	1	3	1	1	5	1	2	1	2	5	2
4	0.053	7	2	0	0	0	0	0	0	0	0	0	0	0	0	0
5	0.124	17	4	8	8	2	6	1	1	9	3	3	2	4	9	4
6	0.028	4	1	3	19	4	14	2	3	21	6	7	5	11	22	11
7	0.094	13	3	6	14	3	11	2	2	16	5	5	3	8	16	8
8	0.015	2	1	1	2	1	2	0	0	3	1	1	1	1	3	1
9	0.020	3	1	1	3	1	2	0	1	3	1	1	1	2	4	2
10	0.137	18	5	9	21	5	16	3	3	23	7	8	5	12	24	12
11	0.041	5	1	3	6	1	5	1	1	7	2	2	2	3	7	3
12	0.044	6	2	3	7	2	5	1	1	8	2	2	2	4	8	4
13	0.029	4	1	2	5	1	3	1	1	5	1	2	1	3	5	3
14	0.069	9	2	4	11	2	8	1	2	12	3	4	3	6	12	6
15	0.140	19	5	9	22	5	16	3	4	24	7	8	5	12	24	12
16	0.069	9	2	4	11	2	8	1	2	12	3	4	3	6	12	6

2026  
External Trip Table

	Direction	2006 DHV	2006 E-E trip	E-E Trip Probability	Growth Factor 2026	2026 DHV	2026 E-E trip	2026 E-I trip
<b>Node 1</b>	Enter	635	300	0.47	1.2516	795	75	85
	Exit	595	190	0.32	1.2516	745	50	100
<b>Node 2</b>	Enter	475	190	0.40	1.2516	595	50	70
	Exit	390	235	0.60	1.2516	490	60	40
<b>Node 3</b>	Enter	510	235	0.46	1.2516	640	60	70
	Exit	475	300	0.63	1.2516	595	75	45

2026

Trip Attraction and Production Probabilities

Zone	1	2	3	4	5	6	7	8	9	10	11	12	13	14	15	16 Total
Total New Trips	191	50	0	117	244	48	157	25	36	348	90	110	71	150	234	1115 1986
Entering Trips	52	28	0	58	74	31	99	15	24	174	49	50	29	81	147	73 984
Attraction Probability	0.053	0.028	0.000	0.059	0.075	0.032	0.101	0.015	0.024	0.177	0.050	0.051	0.029	0.082	0.149	0.074
Exiting Trips	139	22	0	59	170	17	58	9	13	174	41	60	42	69	86	43 1002
Production Probability	0.139	0.022	0.000	0.059	0.170	0.017	0.058	0.009	0.013	0.174	0.041	0.060	0.042	0.069	0.086	0.043

External-Internal Trip Distribution

Zone	1	2	3	4	5	6	7	8	9	10	11	12	13	14	15	16 Total
Node 1	4	2	0	5	6	3	9	1	2	15	4	4	3	7	13	6 85
Node 2	4	2	0	4	5	2	7	1	2	12	3	4	2	6	10	5 70
Node 3	4	2	0	4	5	2	7	1	2	12	3	4	2	6	10	5 70

Internal-External Trip Distribution

Zone	1	2	3	4	5	6	7	8	9	10	11	12	13	14	15	16 Total
Node 1	14	2	0	6	17	2	6	1	1	17	4	6	4	7	9	4 100
Node 2	6	1	0	2	7	1	2	0	1	7	2	2	2	3	3	2 40
Node 3	6	1	0	3	8	1	3	0	1	8	2	3	2	3	4	2 45

Internal-Internal Trip

Zone	1	2	3	4	5	6	7	8	9	10	11	12	13	14	15	16 Total
Total New Trips	191	50	0	117	244	48	157	25	36	348	90	110	71	150	234	1115
Total Internal-Internal Trip	153	40	0	93	196	38	124	20	28	276	71	87	57	119	185	90
Entering Trips	48	26	0	53	68	28	90	14	22	159	45	46	26	74	134	67 899
Attraction Probability	0.053	0.028	0.000	0.059	0.075	0.032	0.101	0.015	0.024	0.177	0.050	0.051	0.029	0.082	0.149	0.074
Exiting Trips	125	20	0	53	153	15	52	8	12	157	37	54	38	62	77	39 902
Production Probability	0.139	0.022	0.000	0.059	0.170	0.017	0.058	0.009	0.013	0.174	0.041	0.060	0.042	0.069	0.086	0.043



Internal/External Distribution		2026															
Zone		1	2	3	4	5	6	7	8	9	10	11	12	13	14	15	16
Attractions		48	26	0	53	68	28	90	14	22	159	45	46	26	74	134	67
	1	0.053	1	0	3	4	1	5	1	1	8	2	2	1	4	7	4
	2	0.028	1	0	2	2	1	3	0	1	5	1	1	1	2	4	2
	3	0.000	0	0	0	0	0	0	0	0	0	0	0	0	0	0	0
	4	0.059	3	2	0	3	4	2	5	1	9	3	3	2	4	8	4
	5	0.075	4	2	0	4	5	2	7	1	12	3	3	2	6	10	5
	6	0.032	1	1	0	2	2	1	3	0	5	1	1	1	2	4	2
	7	0.101	5	3	0	5	7	3	9	1	16	5	5	3	7	14	7
	8	0.015	1	0	0	1	1	0	1	0	2	1	1	0	1	2	1
	9	0.024	1	1	0	1	2	1	2	0	4	1	1	1	2	3	2
	10	0.177	8	5	0	9	12	5	16	2	28	8	8	5	13	24	12
	11	0.050	2	1	0	3	3	1	5	1	8	2	2	1	4	7	3
	12	0.051	2	1	0	3	3	1	5	1	8	2	2	1	4	7	3
	13	0.029	1	1	0	2	2	1	3	0	5	1	1	1	2	4	2
	14	0.082	4	2	0	4	6	2	7	1	13	4	4	2	6	11	5
	15	0.149	7	4	0	8	10	4	14	2	24	7	7	4	11	20	10
16	0.074	4	2	0	4	5	2	7	1	12	3	3	2	5	10	5	
Zone		125	20	3	4	5	6	7	8	9	10	11	12	13	14	15	16
Production		17	3	0	7	21	15	52	8	12	157	37	54	38	62	77	39
	1	0.139	3	0	1	3	2	7	1	1	22	5	7	5	9	11	5
	2	0.022	0	0	0	1	0	1	0	0	3	1	1	1	1	2	1
	3	0.000	0	0	0	0	0	0	0	0	0	0	0	0	0	0	0
	4	0.059	7	1	0	3	9	1	3	0	9	2	3	2	4	5	2
	5	0.170	21	3	0	9	26	9	9	1	27	6	9	6	11	13	7
	6	0.017	2	0	0	1	3	0	1	0	3	1	1	1	1	1	1
	7	0.058	7	1	0	3	9	1	3	0	9	2	3	2	4	4	2
	8	0.009	1	0	0	0	1	0	0	0	1	0	0	0	1	1	0
	9	0.013	2	0	0	1	2	0	1	0	2	0	1	1	1	1	1
	10	0.174	22	3	0	9	27	9	9	1	27	6	9	7	11	13	7
	11	0.041	5	1	0	2	6	1	2	0	6	2	2	2	3	3	2
	12	0.060	7	1	0	3	9	1	3	0	9	2	3	2	4	5	2
	13	0.042	5	1	0	2	6	1	2	0	7	2	2	2	3	3	2
	14	0.069	9	1	0	4	11	1	4	1	11	3	4	3	4	5	3
	15	0.086	11	2	0	5	13	1	4	1	13	3	5	3	5	7	3
16	0.043	5	1	0	2	7	1	2	0	7	2	2	2	3	3	2	

2006  
Independence - Thru Traffic Volumes  
E-E Trips

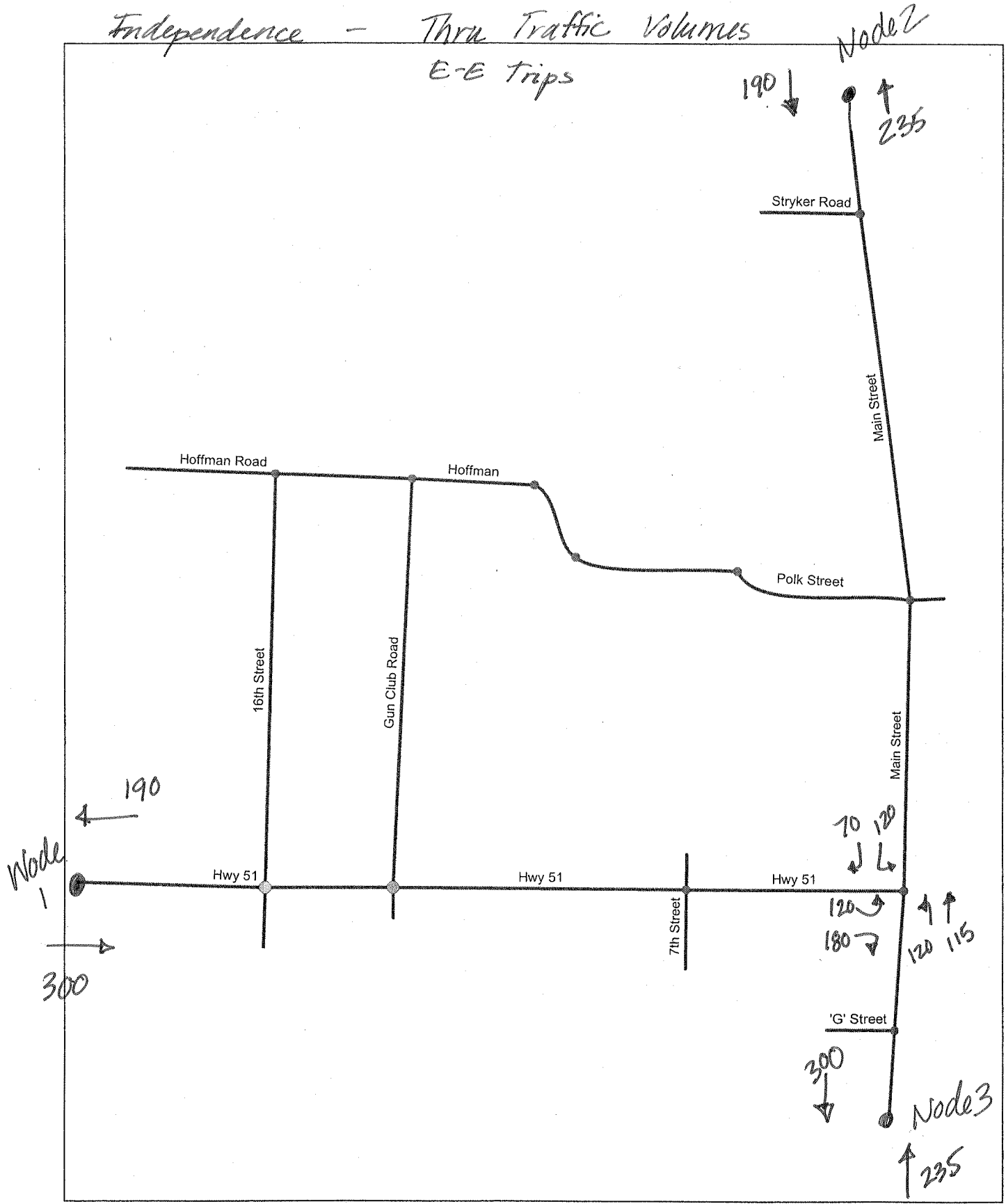

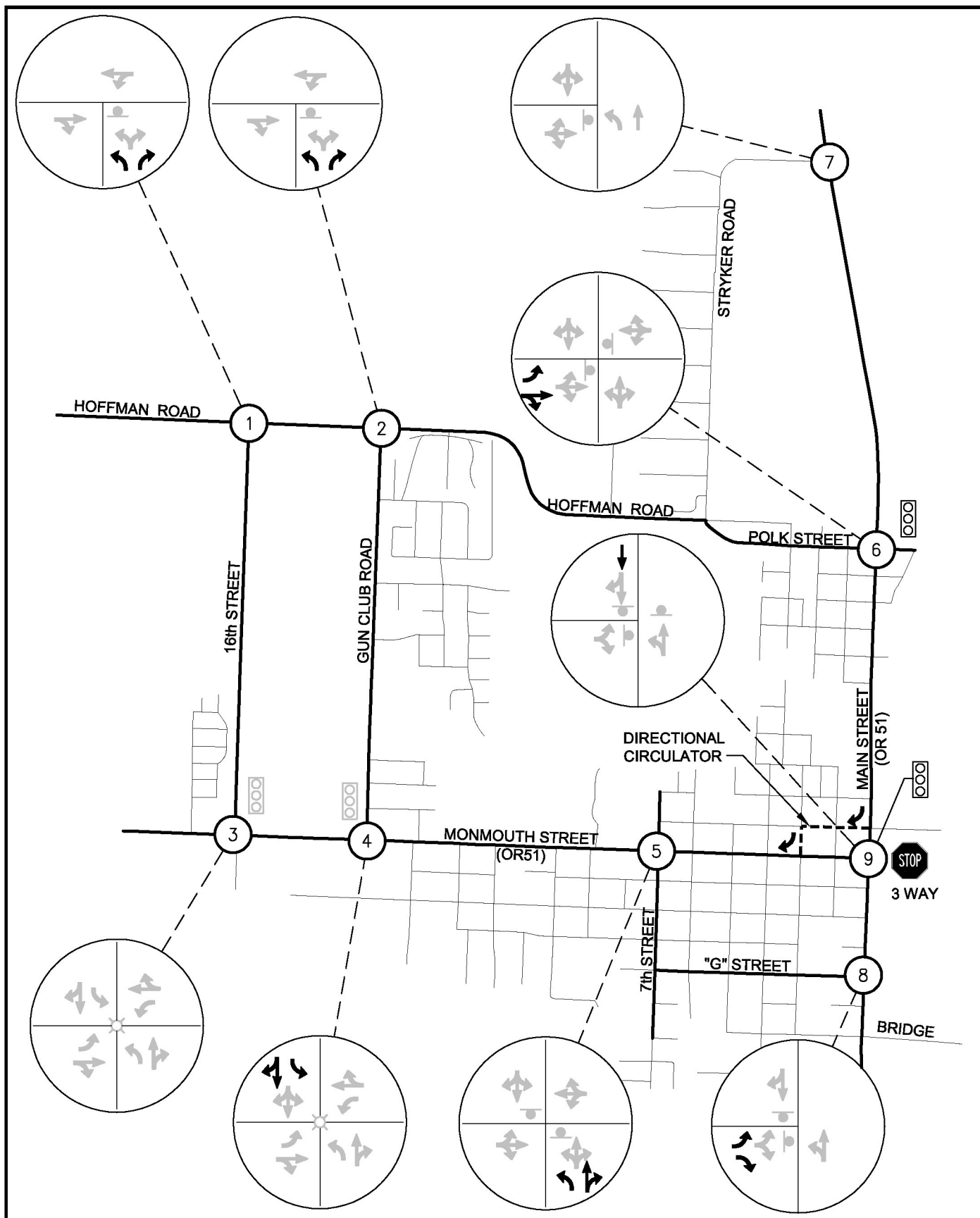

Parametrix DATE: Feb 08, 2007 FILE: PO2395051P05F-01



**LEGEND**

- SIGNALIZED INTERSECTION
- STOP CONTROLLED
- EXISTING TRAFFIC MOVEMENT
- WITH IMPROVEMENTS

**Intersection Improvements**

INDEPENDENCE, OREGON

Oregon Department of Transportation Transportation Development Branch Transportation Planning Analysis Unit					
<b>Preliminary Traffic Signal Warrant Analysis<sup>1</sup></b>					
Major Street: <i>Main St. (OR 51)</i>			Minor Street: <i>Polk St.</i>		
Project: <i>Independence TSP</i>			City/County: <i>Polk Co.</i>		
Year: <i>2042</i>			Alternative: <i>A-Build-out of UGB</i>		
<b>Preliminary Signal Warrant Volumes</b>					
Number of Approach Lanes		ADT on Major Street Approaching From Both Directions		ADT on Minor Street, Highest Approaching Volume	
Major Street	Minor Street	Percent of Standard Warrants		Percent of Standard Warrants	
		100		70	
<b>Case A: Minimum Vehicular Traffic</b>					
1	1	8,850	6,200	2,650	1,850
2 or more	1	10,600	7,400	2,650	1,850
2 or more	2 or more	10,600	7,400	3,550	2,500
1	2 or more	8,850	6,200	3,550	2,500
<b>Case B: Interruption of Continuous Traffic</b>					
1	1	13,300	9,300	1,350	950
2 or more	1	15,900	1,100	1,350	950
2 or more	2 or more	15,900	1,100	1,750	1,250
1	2 or more	13,300	9,300	1,750	1,250
5.65% of the above ADT volumes is equal to the MUTCD vehicles per hour (vph)					
<input checked="" type="checkbox"/>	100 percent of standard warrants				
	70 percent of standard warrants <sup>2</sup>				
<b>Preliminary Signal Warrant Calculation</b>					
	Street	Number of Lanes	Warrant Volumes	Approach Volumes	Warrant Met
Case A	Major	1	8850	9700	YES
	Minor	1	2650	3200	YES
Case B	Major	1	13300	9700	NO
	Minor	1	1350	3200	YES
Analyst and Date: <i>SAT 1/07</i>			Reviewer and Date:		

<sup>1</sup> Meeting preliminary signal warrants does not guarantee that a signal will be installed. Before a signal can be installed a traffic signal investigation must be conducted or reviewed by the Region Traffic Manager. Traffic signal warrants must be met and the State Traffic Engineer's approval obtained before a traffic signal can be installed on a state highway.

<sup>2</sup> Used due to 85<sup>th</sup> percentile speed in excess of 40 mph or isolated community with population of less than 10,000.

Oregon Department of Transportation Transportation Development Branch Transportation Planning Analysis Unit					
<b>Preliminary Traffic Signal Warrant Analysis<sup>1</sup></b>					
Major Street: <i>Main St. (OR 51)</i>			Minor Street: <i>Menmouth St (OR 51)</i>		
Project: <i>Independence TSP</i>			City/County: <i>Polk Co.</i>		
Year: <i>2042</i>			Alternative: <i>Full UGB Build-out</i>		
<b>Preliminary Signal Warrant Volumes</b>					
Number of Approach Lanes		ADT on Major Street Approaching From Both Directions		ADT on Minor Street, Highest Approaching Volume	
Major Street	Minor Street	Percent of Standard Warrants		Percent of Standard Warrants	
		100	70	100	70
<b>Case A: Minimum Vehicular Traffic</b>					
1	1	8,850	6,200	2,650	1,850
2 or more	1	10,600	7,400	2,650	1,850
2 or more	2 or more	10,600	7,400	3,550	2,500
1	2 or more	8,850	6,200	3,550	2,500
<b>Case B: Interruption of Continuous Traffic</b>					
1	1	13,300	9,300	1,350	950
2 or more	1	15,900	1,100	1,350	950
2 or more	2 or more	15,900	1,100	1,750	1,250
1	2 or more	13,300	9,300	1,750	1,250
5.65% of the above ADT volumes is equal to the MUTCD vehicles per hour (vph)					
<i>X</i>	100 percent of standard warrants				
	70 percent of standard warrants <sup>2</sup>				
<b>Preliminary Signal Warrant Calculation</b>					
	Street	Number of Lanes	Warrant Volumes	Approach Volumes	Warrant Met
Case A	Major	<i>1</i>	<i>8850</i>	<i>10,500</i>	<i>Yes</i>
	Minor	<i>1</i>	<i>2650</i>	<i>3400</i>	<i>Yes</i>
Case B	Major	<i>1</i>	<i>13300</i>	<i>10,500</i>	<i>No</i>
	Minor	<i>1</i>	<i>1350</i>	<i>3400</i>	<i>Yes</i>
Analyst and Date: <i>SNO 1/07</i>		Reviewer and Date:			

<sup>1</sup> Meeting preliminary signal warrants does not guarantee that a signal will be installed. Before a signal can be installed a traffic signal investigation must be conducted or reviewed by the Region Traffic Manager. Traffic signal warrants must be met and the State Traffic Engineer's approval obtained before a traffic signal can be installed on a state highway.

<sup>2</sup> Used due to 85<sup>th</sup> percentile speed in excess of 40 mph or isolated community with population of less than 10,000.



**APPENDIX SECTION B-5**

**2026 Volumes and Operations Analysis**





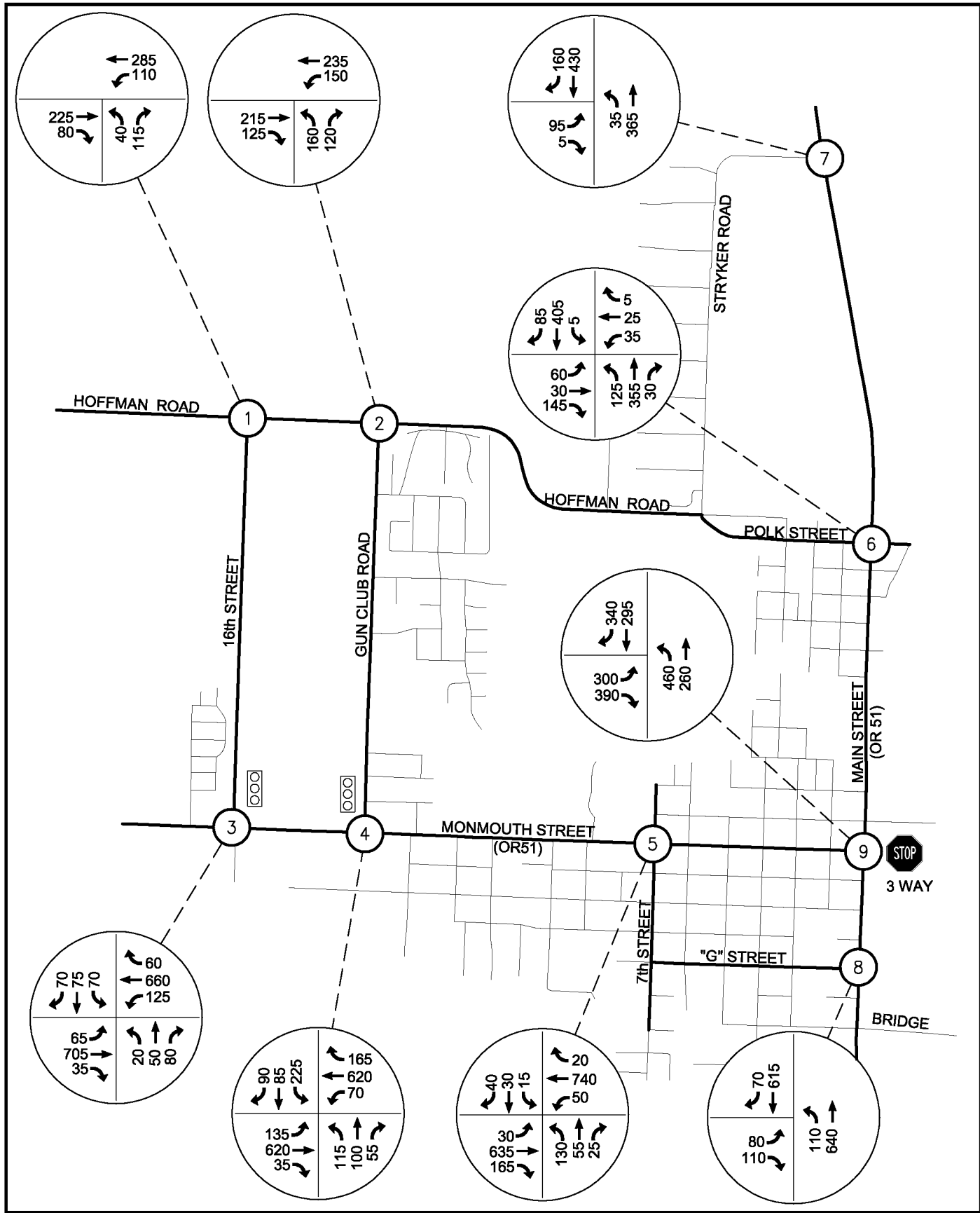

Parametrix DATE: Feb 08, 2007 FILE: PO2396051P05F-04









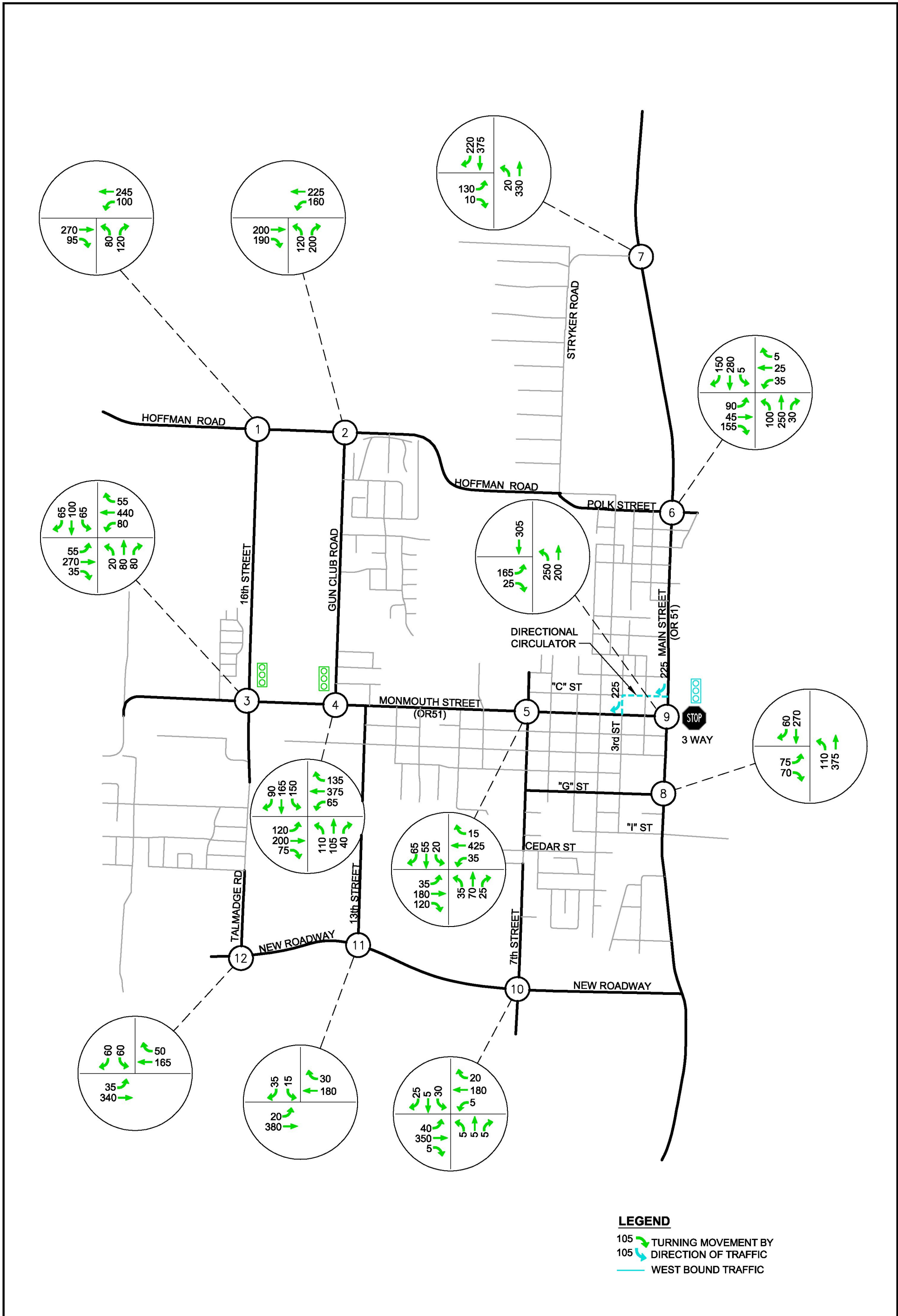













**LEGEND**

↪ 105 TURNING MOVEMENT BY DIRECTION OF TRAFFIC

**Figure 1-1**  
**Alternative 1: 2026**  
**Without Improvements**  
 INDEPENDENCE, OREGON



1: Hwy 51 & 16th Street



												
Movement	EBL	EBT	EBR	WBL	WBT	WBR	NBL	NBT	NBR	SBL	SBT	SBR
Lane Configurations												
Ideal Flow (vphpl)	1800	1800	1800	1800	1800	1800	1800	1800	1800	1800	1800	1800
Total Lost time (s)	4.0	4.0		4.0	4.0		4.0	4.0		4.0	4.0	
Lane Util. Factor	1.00	1.00		1.00	1.00		1.00	1.00		1.00	1.00	
Frt	1.00	0.99		1.00	0.99		1.00	0.91		1.00	0.93	
Flt Protected	0.95	1.00		0.95	1.00		0.95	1.00		0.95	1.00	
Satd. Flow (prot)	1676	1752		1676	1743		1676	1601		1676	1637	
Flt Permitted	0.95	1.00		0.95	1.00		0.59	1.00		0.62	1.00	
Satd. Flow (perm)	1676	1752		1676	1743		1041	1601		1093	1637	
Volume (vph)	65	705	35	125	660	60	20	50	80	70	75	70
Peak-hour factor, PHF	0.92	0.92	0.92	0.92	0.92	0.92	0.92	0.92	0.92	0.92	0.92	0.92
Adj. Flow (vph)	71	766	38	136	717	65	22	54	87	76	82	76
RTOR Reduction (vph)	0	2	0	0	3	0	0	61	0	0	35	0
Lane Group Flow (vph)	71	802	0	136	779	0	22	80	0	76	123	0
Turn Type	Prot		Prot		Perm		Perm		Perm		Perm	
Protected Phases	5	2		1	6			8				4
Permitted Phases							8				4	
Actuated Green, G (s)	17.0	40.0		17.0	40.0		26.0	26.0		26.0	26.0	
Effective Green, g (s)	17.0	40.0		17.0	40.0		26.0	26.0		26.0	26.0	
Actuated g/C Ratio	0.18	0.42		0.18	0.42		0.27	0.27		0.27	0.27	
Clearance Time (s)	4.0	4.0		4.0	4.0		4.0	4.0		4.0	4.0	
Lane Grp Cap (vph)	300	738		300	734		285	438		299	448	
v/s Ratio Prot	0.04	c0.46		c0.08	0.45			0.05			c0.08	
v/s Ratio Perm							0.02			0.07		
v/c Ratio	0.24	1.09		0.45	1.06		0.08	0.18		0.25	0.27	
Uniform Delay, d1	33.4	27.5		34.8	27.5		25.6	26.4		26.9	27.1	
Progression Factor	1.00	1.00		0.68	1.30		1.00	1.00		1.00	1.00	
Incremental Delay, d2	1.9	59.3		0.4	30.7		0.5	0.9		2.0	1.5	
Delay (s)	35.3	86.8		24.1	66.5		26.1	27.3		29.0	28.6	
Level of Service	D	F		C	E		C	C		C	C	
Approach Delay (s)		82.6			60.2			27.1			28.7	
Approach LOS		F			E			C			C	
<b>Intersection Summary</b>												
HCM Average Control Delay			63.3			HCM Level of Service				E		
HCM Volume to Capacity ratio			0.70									
Actuated Cycle Length (s)			95.0			Sum of lost time (s)			12.0			
Intersection Capacity Utilization			74.1%			ICU Level of Service				D		
Analysis Period (min)			15									

c Critical Lane Group

















2: Hwy 51 & Gun Club Road

Movement	EBL	EBT	EBR	WBL	WBT	WBR	NBL	NBT	NBR	SBL	SBT	SBR
Lane Configurations												
Ideal Flow (vphpl)	1800	1800	1800	1800	1800	1800	1800	1800	1800	1800	1800	1800
Total Lost time (s)	4.0	4.0		4.0	4.0		4.0	4.0			4.0	
Lane Util. Factor	1.00	1.00		1.00	1.00		1.00	1.00			1.00	
Frts	1.00	0.99		1.00	0.97		1.00	0.95			0.97	
Flt Protected	0.95	1.00		0.95	1.00		0.95	1.00			0.97	
Satd. Flow (prot)	1676	1751		1676	1709		1676	1671			1664	
Flt Permitted	0.95	1.00		0.95	1.00		0.55	1.00			0.64	
Satd. Flow (perm)	1676	1751		1676	1709		967	1671			1103	
Volume (vph)	135	620	35	70	620	165	115	100	55	225	85	90
Peak-hour factor, PHF	0.92	0.92	0.92	0.92	0.92	0.92	0.92	0.92	0.92	0.92	0.92	0.92
Adj. Flow (vph)	147	674	38	76	674	179	125	109	60	245	92	98
RTOR Reduction (vph)	0	2	0	0	10	0	0	21	0	0	11	0
Lane Group Flow (vph)	147	710	0	76	843	0	125	148	0	0	424	0
Turn Type	Prot		Prot		Perm		Perm		Perm		Perm	
Protected Phases	5	2		1	6			8				4
Permitted Phases							8			4		
Actuated Green, G (s)	17.0	40.0		17.0	40.0		26.0	26.0			26.0	
Effective Green, g (s)	17.0	40.0		17.0	40.0		26.0	26.0			26.0	
Actuated g/C Ratio	0.18	0.42		0.18	0.42		0.27	0.27			0.27	
Clearance Time (s)	4.0	4.0		4.0	4.0		4.0	4.0			4.0	
Lane Grp Cap (vph)	300	737		300	720		265	457			302	
v/s Ratio Prot	c0.09	0.41		0.05	c0.49			0.09				
v/s Ratio Perm							0.13				c0.38	
v/c Ratio	0.49	0.96		0.25	1.17		0.47	0.32			1.40	
Uniform Delay, d1	35.1	26.8		33.5	27.5		28.8	27.5			34.5	
Progression Factor	1.12	0.86		1.00	1.00		1.00	1.00			1.00	
Incremental Delay, d2	1.9	12.2		2.0	91.4		5.9	1.9			200.7	
Delay (s)	41.3	35.2		35.6	118.9		34.7	29.4			235.2	
Level of Service	D	D		D	F		C	C			F	
Approach Delay (s)		36.2			112.1			31.6			235.2	
Approach LOS		D			F			C			F	
<b>Intersection Summary</b>												
HCM Average Control Delay			98.1			HCM Level of Service					F	
HCM Volume to Capacity ratio			1.11									
Actuated Cycle Length (s)			95.0			Sum of lost time (s)			12.0			
Intersection Capacity Utilization			99.0%			ICU Level of Service					F	
Analysis Period (min)			15									
c Critical Lane Group												

4: Hwy 51 & Main Street

Movement	EBL	EBR	NBL	NBT	SBT	SBR
Lane Configurations						
Sign Control	Stop		Stop		Stop	
Volume (vph)	300	390	460	260	295	340
Peak Hour Factor	0.92	0.92	0.92	0.92	0.92	0.92
Hourly flow rate (vph)	326	424	500	283	321	370
Direction, Lane #	EB 1	NB 1	SB 1			
Volume Total (vph)	750	783	690			
Volume Left (vph)	326	500	0			
Volume Right (vph)	424	0	370			
Hadj (s)	-0.22	0.16	-0.29			
Departure Headway (s)	6.8	7.1	6.7			
Degree Utilization, x	1.41	1.55	1.28			
Capacity (veh/h)	535	508	547			
Control Delay (s)	215.1	277.9	162.8			
Approach Delay (s)	215.1	277.9	162.8			
Approach LOS	F	F	F			
Intersection Summary						
Delay			221.0			
HCM Level of Service			F			
Intersection Capacity Utilization			132.5%	ICU Level of Service	H	
Analysis Period (min)			15			

5: Polk Street & Main Street

												
Movement	EBL	EBT	EBR	WBL	WBT	WBR	NBL	NBT	NBR	SBL	SBT	SBR
Lane Configurations												
Sign Control		Stop			Stop			Free			Free	
Grade		0%			0%			0%			0%	
Volume (veh/h)	60	30	145	35	25	5	125	355	30	5	405	85
Peak Hour Factor	0.92	0.92	0.92	0.92	0.92	0.92	0.92	0.92	0.92	0.92	0.92	0.92
Hourly flow rate (vph)	65	33	158	38	27	5	136	386	33	5	440	92
Pedestrians												
Lane Width (ft)												
Walking Speed (ft/s)												
Percent Blockage												
Right turn flare (veh)												
Median type		None			None							
Median storage veh												
Upstream signal (ft)												
pX, platoon unblocked												
vC, conflicting volume	1190	1188	486	1345	1217	402	533			418		
vC1, stage 1 conf vol												
vC2, stage 2 conf vol												
vCu, unblocked vol	1190	1188	486	1345	1217	402	533			418		
tC, single (s)	7.1	6.5	6.2	7.1	6.5	6.2	4.1			4.1		
tC, 2 stage (s)												
tF (s)	3.5	4.0	3.3	3.5	4.0	3.3	2.2			2.2		
p0 queue free %	49	80	73	47	83	99	87			100		
cM capacity (veh/h)	127	163	581	71	156	648	1035			1141		
<b>Direction, Lane #</b>	<b>EB 1</b>	<b>WB 1</b>	<b>NB 1</b>	<b>SB 1</b>								
Volume Total	255	71	554	538								
Volume Left	65	38	136	5								
Volume Right	158	5	33	92								
cSH	259	99	1035	1141								
Volume to Capacity	0.99	0.72	0.13	0.00								
Queue Length 95th (ft)	239	92	11	0								
Control Delay (s)	94.0	103.4	3.4	0.1								
Lane LOS	F	F	A	A								
Approach Delay (s)	94.0	103.4	3.4	0.1								
Approach LOS	F	F										
<b>Intersection Summary</b>												
Average Delay			23.5									
Intersection Capacity Utilization			82.4%		ICU Level of Service					E		
Analysis Period (min)			15									

6: Stryker Road & Main Street

Movement	EBL	EBR	NBL	NBT	SBT	SBR
Lane Configurations						
Sign Control	Stop			Free	Free	
Grade	0%			0%	0%	
Volume (veh/h)	95	5	35	365	430	160
Peak Hour Factor	0.92	0.92	0.92	0.92	0.92	0.92
Hourly flow rate (vph)	103	5	38	397	467	174
Pedestrians						
Lane Width (ft)						
Walking Speed (ft/s)						
Percent Blockage						
Right turn flare (veh)						
Median type	None					
Median storage veh						
Upstream signal (ft)						
pX, platoon unblocked						
vC, conflicting volume	1027	554	641			
vC1, stage 1 conf vol						
vC2, stage 2 conf vol						
vCu, unblocked vol	1027	554	641			
tC, single (s)	6.4	6.2	4.1			
tC, 2 stage (s)						
tF (s)	3.5	3.3	2.2			
p0 queue free %	59	99	96			
cM capacity (veh/h)	249	532	943			
<b>Direction, Lane #</b>	<b>EB 1</b>	<b>NB 1</b>	<b>NB 2</b>	<b>SB 1</b>		
Volume Total	109	38	397	641		
Volume Left	103	38	0	0		
Volume Right	5	0	0	174		
cSH	256	943	1700	1700		
Volume to Capacity	0.42	0.04	0.23	0.38		
Queue Length 95th (ft)	50	3	0	0		
Control Delay (s)	29.1	9.0	0.0	0.0		
Lane LOS	D	A				
Approach Delay (s)	29.1	0.8		0.0		
Approach LOS	D					
<b>Intersection Summary</b>						
Average Delay			3.0			
Intersection Capacity Utilization		46.7%		ICU Level of Service	A	
Analysis Period (min)			15			

8: Hoffman Road & 16th Street



Movement	EBT	EBR	WBL	WBT	NBL	NBR
Lane Configurations	↔			↔		↔
Sign Control	Free			Free	Stop	
Grade	0%			0%	0%	
Volume (veh/h)	225	80	110	285	40	115
Peak Hour Factor	0.92	0.92	0.92	0.92	0.92	0.92
Hourly flow rate (vph)	245	87	120	310	43	125
Pedestrians						
Lane Width (ft)						
Walking Speed (ft/s)						
Percent Blockage						
Right turn flare (veh)						
Median type	None					
Median storage veh						
Upstream signal (ft)						
pX, platoon unblocked						
vC, conflicting volume			332		837	288
vC1, stage 1 conf vol						
vC2, stage 2 conf vol						
vCu, unblocked vol			332		837	288
tC, single (s)			4.1		6.4	6.2
tC, 2 stage (s)						
tF (s)			2.2		3.5	3.3
p0 queue free %			90		86	83
cM capacity (veh/h)			1228		304	751
<b>Direction, Lane #</b>	<b>EB 1</b>	<b>WB 1</b>	<b>NB 1</b>			
Volume Total	332	429	168			
Volume Left	0	120	43			
Volume Right	87	0	125			
cSH	1700	1228	544			
Volume to Capacity	0.20	0.10	0.31			
Queue Length 95th (ft)	0	8	33			
Control Delay (s)	0.0	3.0	14.5			
Lane LOS		A	B			
Approach Delay (s)	0.0	3.0	14.5			
Approach LOS			B			
<b>Intersection Summary</b>						
Average Delay			4.0			
Intersection Capacity Utilization			59.7%	ICU Level of Service	B	
Analysis Period (min)			15			



















9: Hoffman Road & Gun Club Road

Movement	EBT	EBR	WBL	WBT	NBL	NBR
Lane Configurations	↔			↔		↔
Sign Control	Free			Free	Stop	
Grade	0%			0%	0%	
Volume (veh/h)	215	125	150	235	160	120
Peak Hour Factor	0.92	0.92	0.92	0.92	0.92	0.92
Hourly flow rate (vph)	234	136	163	255	174	130
Pedestrians						
Lane Width (ft)						
Walking Speed (ft/s)						
Percent Blockage						
Right turn flare (veh)						
Median type	None					
Median storage veh						
Upstream signal (ft)						
pX, platoon unblocked						
vC, conflicting volume			370		883	302
vC1, stage 1 conf vol						
vC2, stage 2 conf vol						
vCu, unblocked vol			370		883	302
tC, single (s)			4.1		6.4	6.2
tC, 2 stage (s)						
tF (s)			2.2		3.5	3.3
p0 queue free %			86		36	82
cM capacity (veh/h)			1189		273	738
<b>Direction, Lane #</b>	<b>EB 1</b>	<b>WB 1</b>	<b>NB 1</b>			
Volume Total	370	418	304			
Volume Left	0	163	174			
Volume Right	136	0	130			
cSH	1700	1189	374			
Volume to Capacity	0.22	0.14	0.81			
Queue Length 95th (ft)	0	12	180			
Control Delay (s)	0.0	4.2	45.4			
Lane LOS		A	E			
Approach Delay (s)	0.0	4.2	45.4			
Approach LOS			E			
<b>Intersection Summary</b>						
Average Delay			14.3			
Intersection Capacity Utilization			68.9%	ICU Level of Service	C	
Analysis Period (min)			15			





















14: 'G' Street & Main Street

Movement	EBL	EBR	NBL	NBT	SBT	SBR
Lane Configurations						
Sign Control	Stop		Free		Free	
Grade	0%		0%		0%	
Volume (veh/h)	80	110	110	640	615	70
Peak Hour Factor	0.92	0.92	0.92	0.92	0.92	0.92
Hourly flow rate (vph)	87	120	120	696	668	76
Pedestrians						
Lane Width (ft)						
Walking Speed (ft/s)						
Percent Blockage						
Right turn flare (veh)						
Median type: None						
Median storage (veh)						
Upstream signal (ft)						
pX, platoon unblocked						
vC, conflicting volume	1641	707	745			
vC1, stage 1 conf vol						
vC2, stage 2 conf vol						
vCu, unblocked vol	1641	707	745			
tC, single (s)	6.4	6.2	4.1			
tC, 2 stage (s)						
tF (s)	3.5	3.3	2.2			
p0 queue free %	8	73	86			
cM capacity (veh/h)	95	436	863			
<b>Direction, Lane #</b>	<b>EB 1</b>	<b>NB 1</b>	<b>SB 1</b>			
Volume Total	207	815	745			
Volume Left	87	120	0			
Volume Right	120	0	76			
cSH	173	863	1700			
Volume to Capacity	1.19	0.14	0.44			
Queue Length 95th (ft)	278	12	0			
Control Delay (s)	183.0	3.4	0.0			
Lane LOS	F	A				
Approach Delay (s)	183.0	3.4	0.0			
Approach LOS	F					
<b>Intersection Summary</b>						
Average Delay			23.0			
Intersection Capacity Utilization			102.4%	ICU Level of Service	G	
Analysis Period (min)			15			

15: Hwy 51 & 7th Street





















												
Movement	EBL	EBT	EBR	WBL	WBT	WBR	NBL	NBT	NBR	SBL	SBT	SBR
Lane Configurations												
Sign Control	Free			Free			Stop			Stop		
Grade	0%			0%			0%			0%		
Volume (veh/h)	30	635	165	50	740	20	130	55	25	15	30	40
Peak Hour Factor	0.92	0.92	0.92	0.92	0.92	0.92	0.92	0.92	0.92	0.92	0.92	0.92
Hourly flow rate (vph)	33	690	179	54	804	22	141	60	27	16	33	43
Pedestrians												
Lane Width (ft)												
Walking Speed (ft/s)												
Percent Blockage												
Right turn flare (veh)												
Median type	None						None					
Median storage veh												
Upstream signal (ft)												
pX, platoon unblocked												
vC, conflicting volume	826			870			1829	1780	780	1826	1859	815
vC1, stage 1 conf vol												
vC2, stage 2 conf vol												
vCu, unblocked vol	826			870			1829	1780	780	1826	1859	815
tC, single (s)	4.1			4.1			7.1	6.5	6.2	7.1	6.5	6.2
tC, 2 stage (s)												
tF (s)	2.2			2.2			3.5	4.0	3.3	3.5	4.0	3.3
p0 queue free %	96			93			0	18	93	1	50	88
cM capacity (veh/h)	805			775			29	73	395	16	65	377
<b>Direction, Lane #</b>	<b>EB 1</b>	<b>WB 1</b>	<b>NB 1</b>	<b>SB 1</b>								
Volume Total	902	880	228	92								
Volume Left	33	54	141	16								
Volume Right	179	22	27	43								
cSH	805	775	40	58								
Volume to Capacity	0.04	0.07	5.69	1.60								
Queue Length 95th (ft)	3	6	Err	211								
Control Delay (s)	1.1	1.9	Err	455.8								
Lane LOS	A	A	F	F								
Approach Delay (s)	1.1	1.9	Err	455.8								
Approach LOS			F	F								
<b>Intersection Summary</b>												
Average Delay			1106.5									
Intersection Capacity Utilization			89.5%	ICU Level of Service	E							
Analysis Period (min)			15									

1: Hwy 51 & 16th Street

												
Movement	EBL	EBT	EBR	WBL	WBT	WBR	NBL	NBT	NBR	SBL	SBT	SBR
Lane Configurations												
Ideal Flow (vphpl)	1800	1800	1800	1800	1800	1800	1800	1800	1800	1800	1800	1800
Total Lost time (s)	4.0	4.0		4.0	4.0		4.0	4.0		4.0	4.0	
Lane Util. Factor	1.00	1.00		1.00	1.00		1.00	1.00		1.00	1.00	
Frt	1.00	0.98		1.00	0.98		1.00	0.93		1.00	0.94	
Flt Protected	0.95	1.00		0.95	1.00		0.95	1.00		0.95	1.00	
Satd. Flow (prot)	1676	1734		1676	1735		1676	1632		1676	1660	
Flt Permitted	0.95	1.00		0.95	1.00		0.55	1.00		0.56	1.00	
Satd. Flow (perm)	1676	1734		1676	1735		976	1632		994	1660	
Volume (vph)	55	270	35	80	440	55	20	80	80	65	100	65
Peak-hour factor, PHF	0.92	0.92	0.92	0.92	0.92	0.92	0.92	0.92	0.92	0.92	0.92	0.92
Adj. Flow (vph)	60	293	38	87	478	60	22	87	87	71	109	71
RTOR Reduction (vph)	0	5	0	0	5	0	0	38	0	0	25	0
Lane Group Flow (vph)	60	326	0	87	533	0	22	136	0	71	155	0
Turn Type	Prot		Prot		Perm		Perm		Perm		Perm	
Protected Phases	5	2		1	6			8				4
Permitted Phases							8				4	
Actuated Green, G (s)	17.0	40.0		17.0	40.0		26.0	26.0		26.0	26.0	
Effective Green, g (s)	17.0	40.0		17.0	40.0		26.0	26.0		26.0	26.0	
Actuated g/C Ratio	0.18	0.42		0.18	0.42		0.27	0.27		0.27	0.27	
Clearance Time (s)	4.0	4.0		4.0	4.0		4.0	4.0		4.0	4.0	
Lane Grp Cap (vph)	300	730		300	731		267	447		272	454	
v/s Ratio Prot	0.04	0.19		c0.05	c0.31			0.08			c0.09	
v/s Ratio Perm							0.02			0.07		
v/c Ratio	0.20	0.45		0.29	0.73		0.08	0.30		0.26	0.34	
Uniform Delay, d1	33.2	19.6		33.8	23.0		25.6	27.3		27.0	27.6	
Progression Factor	1.00	1.00		0.87	1.26		1.00	1.00		1.00	1.00	
Incremental Delay, d2	1.5	2.0		1.7	4.4		0.6	1.8		2.3	2.0	
Delay (s)	34.7	21.6		31.0	33.3		26.2	29.1		29.3	29.7	
Level of Service	C	C		C	C		C	C		C	C	
Approach Delay (s)		23.6			33.0			28.8			29.6	
Approach LOS		C			C			C			C	
<b>Intersection Summary</b>												
HCM Average Control Delay			29.3			HCM Level of Service				C		
HCM Volume to Capacity ratio			0.52									
Actuated Cycle Length (s)			95.0			Sum of lost time (s)				12.0		
Intersection Capacity Utilization			58.0%			ICU Level of Service				B		
Analysis Period (min)			15									









c Critical Lane Group

2: Hwy 51 & Gun Club Road



















												
Movement	EBL	EBT	EBR	WBL	WBT	WBR	NBL	NBT	NBR	SBL	SBT	SBR
Lane Configurations												
Ideal Flow (vphpl)	1800	1800	1800	1800	1800	1800	1800	1800	1800	1800	1800	1800
Total Lost time (s)	4.0	4.0		4.0	4.0		4.0	4.0		4.0	4.0	
Lane Util. Factor	1.00	1.00		1.00	1.00		1.00	1.00		1.00	1.00	
Frt	1.00	0.96		1.00	0.96		1.00	0.96		1.00	0.95	
Flt Protected	0.95	1.00		0.95	1.00		0.95	1.00		0.95	1.00	
Satd. Flow (prot)	1676	1692		1676	1695		1676	1692		1676	1671	
Flt Permitted	0.95	1.00		0.95	1.00		0.40	1.00		0.59	1.00	
Satd. Flow (perm)	1676	1692		1676	1695		698	1692		1044	1671	
Volume (vph)	120	200	75	65	375	135	110	105	40	150	165	90
Peak-hour factor, PHF	0.92	0.92	0.92	0.92	0.92	0.92	0.92	0.92	0.92	0.92	0.92	0.92
Adj. Flow (vph)	130	217	82	71	408	147	120	114	43	163	179	98
RTOR Reduction (vph)	0	14	0	0	14	0	0	15	0	0	21	0
Lane Group Flow (vph)	130	285	0	71	541	0	120	142	0	163	256	0
Turn Type	Prot		Prot		Perm		Perm		Perm		Perm	
Protected Phases	5	2		1	6			8				4
Permitted Phases							8				4	
Actuated Green, G (s)	17.0	40.0		17.0	40.0		26.0	26.0		26.0	26.0	
Effective Green, g (s)	17.0	40.0		17.0	40.0		26.0	26.0		26.0	26.0	
Actuated g/C Ratio	0.18	0.42		0.18	0.42		0.27	0.27		0.27	0.27	
Clearance Time (s)	4.0	4.0		4.0	4.0		4.0	4.0		4.0	4.0	
Lane Grp Cap (vph)	300	712		300	714		191	463		286	457	
v/s Ratio Prot	c0.08	0.17		0.04	c0.32			0.08			0.15	
v/s Ratio Perm							c0.17			0.16		
v/c Ratio	0.43	0.40		0.24	0.76		0.63	0.31		0.57	0.56	
Uniform Delay, d1	34.7	19.1		33.4	23.4		30.3	27.4		29.7	29.6	
Progression Factor	1.09	0.82		1.00	1.00		1.00	1.00		1.00	1.00	
Incremental Delay, d2	4.2	1.6		1.9	7.4		14.6	1.7		8.0	4.9	
Delay (s)	41.9	17.3		35.3	30.8		44.9	29.1		37.7	34.5	
Level of Service	D	B		D	C		D	C		D	C	
Approach Delay (s)		24.8			31.3			35.9			35.7	
Approach LOS		C			C			D			D	
<b>Intersection Summary</b>												
HCM Average Control Delay			31.5			HCM Level of Service				C		
HCM Volume to Capacity ratio			0.65									
Actuated Cycle Length (s)			95.0			Sum of lost time (s)			12.0			
Intersection Capacity Utilization			71.2%			ICU Level of Service				C		
Analysis Period (min)			15									

c Critical Lane Group







4: Hwy 51 & Main Street

						
Movement	EBL	EBR	NBL	NBT	SBT	SBR
Lane Configurations						
Sign Control	Stop			Stop	Stop	
Volume (vph)	165	25	250	200	305	0
Peak Hour Factor	0.92	0.92	0.92	0.92	0.92	0.92
Hourly flow rate (vph)	179	27	272	217	332	0
Direction, Lane #	EB 1	NB 1	SB 1			
Volume Total (vph)	207	489	332			
Volume Left (vph)	179	272	0			
Volume Right (vph)	27	0	0			
Hadj (s)	0.13	0.15	0.03			
Departure Headway (s)	6.1	5.2	5.3			
Degree Utilization, x	0.35	0.71	0.49			
Capacity (veh/h)	538	672	652			
Control Delay (s)	12.4	19.8	13.3			
Approach Delay (s)	12.4	19.8	13.3			
Approach LOS	B	C	B			
Intersection Summary						
Delay			16.2			
HCM Level of Service			C			
Intersection Capacity Utilization			63.9%	ICU Level of Service	B	
Analysis Period (min)			15			

5: Polk Street & Main Street

												
Movement	EBL	EBT	EBR	WBL	WBT	WBR	NBL	NBT	NBR	SBL	SBT	SBR
Lane Configurations												
Sign Control	Stop			Stop			Free			Free		
Grade	0%			0%			0%			0%		
Volume (veh/h)	90	45	155	35	25	5	100	250	30	5	280	150
Peak Hour Factor	0.92	0.92	0.92	0.92	0.92	0.92	0.92	0.92	0.92	0.92	0.92	0.92
Hourly flow rate (vph)	98	49	168	38	27	5	109	272	33	5	304	163
Pedestrians												
Lane Width (ft)												
Walking Speed (ft/s)												
Percent Blockage												
Right turn flare (veh)												
Median type	None			None								
Median storage veh												
Upstream signal (ft)												
pX, platoon unblocked												
vC, conflicting volume	921	918	386	1095	984	288	467			304		
vC1, stage 1 conf vol												
vC2, stage 2 conf vol												
vCu, unblocked vol	921	918	386	1095	984	288	467			304		
tC, single (s)	7.1	6.5	6.2	7.1	6.5	6.2	4.1			4.1		
tC, 2 stage (s)												
tF (s)	3.5	4.0	3.3	3.5	4.0	3.3	2.2			2.2		
p0 queue free %	53	80	75	66	88	99	90			100		
cM capacity (veh/h)	208	243	662	111	223	751	1094			1256		
<b>Direction, Lane #</b>	<b>EB 1</b>	<b>EB 2</b>	<b>WB 1</b>	<b>NB 1</b>	<b>SB 1</b>							
Volume Total	98	217	71	413	473							
Volume Left	98	0	38	109	5							
Volume Right	0	168	5	33	163							
cSH	208	477	150	1094	1256							
Volume to Capacity	0.47	0.46	0.47	0.10	0.00							
Queue Length 95th (ft)	57	59	55	8	0							
Control Delay (s)	36.7	18.7	48.8	3.0	0.1							
Lane LOS	E	C	E	A	A							
Approach Delay (s)	24.3		48.8	3.0	0.1							
Approach LOS	C		E									
<b>Intersection Summary</b>												
Average Delay			9.8									
Intersection Capacity Utilization			76.8%		ICU Level of Service		D					
Analysis Period (min)			15									

6: Stryker Road & Main Street

Movement	EBL	EBR	NBL	NBT	SBT	SBR
Lane Configurations						
Sign Control	Stop			Free	Free	
Grade	0%			0%	0%	
Volume (veh/h)	130	10	20	330	375	220
Peak Hour Factor	0.92	0.92	0.92	0.92	0.92	0.92
Hourly flow rate (vph)	141	11	22	359	408	239
Pedestrians						
Lane Width (ft)						
Walking Speed (ft/s)						
Percent Blockage						
Right turn flare (veh)						
Median type	None					
Median storage veh						
Upstream signal (ft)						
pX, platoon unblocked						
vC, conflicting volume	929	527	647			
vC1, stage 1 conf vol						
vC2, stage 2 conf vol						
vCu, unblocked vol	929	527	647			
tC, single (s)	6.4	6.2	4.1			
tC, 2 stage (s)						
tF (s)	3.5	3.3	2.2			
p0 queue free %	51	98	98			
cM capacity (veh/h)	290	551	939			
<b>Direction, Lane #</b>	<b>EB 1</b>	<b>NB 1</b>	<b>NB 2</b>	<b>SB 1</b>		
Volume Total	152	22	359	647		
Volume Left	141	22	0	0		
Volume Right	11	0	0	239		
cSH	300	939	1700	1700		
Volume to Capacity	0.51	0.02	0.21	0.38		
Queue Length 95th (ft)	67	2	0	0		
Control Delay (s)	28.7	8.9	0.0	0.0		
Lane LOS	D	A				
Approach Delay (s)	28.7	0.5		0.0		
Approach LOS	D					
<b>Intersection Summary</b>						
Average Delay			3.9			
Intersection Capacity Utilization		49.9%		ICU Level of Service	A	
Analysis Period (min)			15			





8: Hoffman Road & 16th Street

Movement	EBT	EBR	WBL	WBT	NBL	NBR
Lane Configurations	↔			↔	↔	↔
Sign Control	Free			Free	Stop	
Grade	0%			0%	0%	
Volume (veh/h)	270	95	100	245	80	120
Peak Hour Factor	0.92	0.92	0.92	0.92	0.92	0.92
Hourly flow rate (vph)	293	103	109	266	87	130
Pedestrians						
Lane Width (ft)						
Walking Speed (ft/s)						
Percent Blockage						
Right turn flare (veh)						
Median type				None		
Median storage veh						
Upstream signal (ft)						
pX, platoon unblocked						
vC, conflicting volume			397		829	345
vC1, stage 1 conf vol						
vC2, stage 2 conf vol						
vCu, unblocked vol			397		829	345
tC, single (s)			4.1		6.4	6.2
tC, 2 stage (s)						
tF (s)			2.2		3.5	3.3
p0 queue free %			91		72	81
cM capacity (veh/h)			1162		309	698
<b>Direction, Lane #</b>	<b>EB 1</b>	<b>WB 1</b>	<b>NB 1</b>	<b>NB 2</b>		
Volume Total	397	375	87	130		
Volume Left	0	109	87	0		
Volume Right	103	0	0	130		
cSH	1700	1162	309	698		
Volume to Capacity	0.23	0.09	0.28	0.19		
Queue Length 95th (ft)	0	8	28	17		
Control Delay (s)	0.0	3.1	21.2	11.3		
Lane LOS		A	C	B		
Approach Delay (s)	0.0	3.1	15.3			
Approach LOS			C			
<b>Intersection Summary</b>						
Average Delay			4.5			
Intersection Capacity Utilization			55.2%		ICU Level of Service	B
Analysis Period (min)			15			













9: Hoffman Road & Gun Club Road

Movement	EBT	EBR	WBL	WBT	NBL	NBR
Lane Configurations	↔			↔	↔	↔
Sign Control	Free			Free	Stop	
Grade	0%			0%	0%	
Volume (veh/h)	200	190	160	225	120	200
Peak Hour Factor	0.92	0.92	0.92	0.92	0.92	0.92
Hourly flow rate (vph)	217	207	174	245	130	217
Pedestrians						
Lane Width (ft)						
Walking Speed (ft/s)						
Percent Blockage						
Right turn flare (veh)						
Median type	None					
Median storage veh						
Upstream signal (ft)						
pX, platoon unblocked						
vC, conflicting volume			424		913	321
vC1, stage 1 conf vol						
vC2, stage 2 conf vol						
vCu, unblocked vol			424		913	321
tC, single (s)			4.1		6.4	6.2
tC, 2 stage (s)						
tF (s)			2.2		3.5	3.3
p0 queue free %			85		49	70
cM capacity (veh/h)			1135		257	720
<b>Direction, Lane #</b>	<b>EB 1</b>	<b>WB 1</b>	<b>NB 1</b>	<b>NB 2</b>		
Volume Total	424	418	130	217		
Volume Left	0	174	130	0		
Volume Right	207	0	0	217		
cSH	1700	1135	257	720		
Volume to Capacity	0.25	0.15	0.51	0.30		
Queue Length 95th (ft)	0	14	66	32		
Control Delay (s)	0.0	4.5	32.6	12.1		
Lane LOS		A	D	B		
Approach Delay (s)	0.0	4.5	19.8			
Approach LOS			C			
<b>Intersection Summary</b>						
Average Delay			7.4			
Intersection Capacity Utilization			62.2%	ICU Level of Service	B	
Analysis Period (min)			15			

14: 'G' Street & Main Street

Movement	EBL	EBR	NBL	NBT	SBT	SBR
Lane Configurations						
Sign Control	Stop		Free		Free	
Grade	0%		0%		0%	
Volume (veh/h)	75	70	110	375	270	60
Peak Hour Factor	0.92	0.92	0.92	0.92	0.92	0.92
Hourly flow rate (vph)	82	76	120	408	293	65
Pedestrians						
Lane Width (ft)						
Walking Speed (ft/s)						
Percent Blockage						
Right turn flare (veh)						
Median type: None						
Median storage (veh)						
Upstream signal (ft)						
pX, platoon unblocked						
vC, conflicting volume	973	326	359			
vC1, stage 1 conf vol						
vC2, stage 2 conf vol						
vCu, unblocked vol	973	326	359			
tC, single (s)	6.4	6.2	4.1			
tC, 2 stage (s)						
tF (s)	3.5	3.3	2.2			
p0 queue free %	68	89	90			
cM capacity (veh/h)	252	715	1200			
<b>Direction, Lane #</b>	<b>EB 1</b>	<b>NB 1</b>	<b>SB 1</b>			
Volume Total	158	527	359			
Volume Left	82	120	0			
Volume Right	76	0	65			
cSH	366	1200	1700			
Volume to Capacity	0.43	0.10	0.21			
Queue Length 95th (ft)	52	8	0			
Control Delay (s)	22.0	2.7	0.0			
Lane LOS	C	A				
Approach Delay (s)	22.0	2.7	0.0			
Approach LOS	C					
<b>Intersection Summary</b>						
Average Delay			4.7			
Intersection Capacity Utilization			65.0%	ICU Level of Service	C	
Analysis Period (min)			15			

15: Hwy 51 & 7th Street

												
Movement	EBL	EBT	EBR	WBL	WBT	WBR	NBL	NBT	NBR	SBL	SBT	SBR
Lane Configurations		↕			↕			↕			↕	
Sign Control		Free			Free			Stop			Stop	
Grade		0%			0%			0%			0%	
Volume (veh/h)	35	180	120	35	425	15	35	70	25	20	55	65
Peak Hour Factor	0.92	0.92	0.92	0.92	0.92	0.92	0.92	0.92	0.92	0.92	0.92	0.92
Hourly flow rate (vph)	38	196	130	38	462	16	38	76	27	22	60	71
Pedestrians												
Lane Width (ft)												
Walking Speed (ft/s)												
Percent Blockage												
Right turn flare (veh)												
Median type								None			None	
Median storage veh												
Upstream signal (ft)												
pX, platoon unblocked												
vC, conflicting volume	478			326			984	891	261	948	948	470
vC1, stage 1 conf vol												
vC2, stage 2 conf vol												
vCu, unblocked vol	478			326			984	891	261	948	948	470
tC, single (s)	4.1			4.1			7.1	6.5	6.2	7.1	6.5	6.2
tC, 2 stage (s)												
tF (s)	2.2			2.2			3.5	4.0	3.3	3.5	4.0	3.3
p0 queue free %	96			97			75	71	97	87	75	88
cM capacity (veh/h)	1084			1234			155	263	778	172	244	593
<b>Direction, Lane #</b>	<b>EB 1</b>	<b>WB 1</b>	<b>NB 1</b>	<b>SB 1</b>								
Volume Total	364	516	141	152								
Volume Left	38	38	38	22								
Volume Right	130	16	27	71								
cSH	1084	1234	248	310								
Volume to Capacity	0.04	0.03	0.57	0.49								
Queue Length 95th (ft)	3	2	80	64								
Control Delay (s)	1.2	0.9	37.1	27.3								
Lane LOS	A	A	E	D								
Approach Delay (s)	1.2	0.9	37.1	27.3								
Approach LOS			E	D								
<b>Intersection Summary</b>												
Average Delay			8.8									
Intersection Capacity Utilization		52.2%		ICU Level of Service					A			
Analysis Period (min)		15										

16: New Roadway & Talmadge















Movement	EBL	EBT	WBT	WBR	SBL	SBR
Lane Configurations		↕	↕		↕	
Sign Control		Free	Free		Stop	
Grade		0%	0%		0%	
Volume (veh/h)	35	340	165	50	60	60
Peak Hour Factor	0.92	0.92	0.92	0.92	0.92	0.92
Hourly flow rate (vph)	38	370	179	54	65	65
Pedestrians						
Lane Width (ft)						
Walking Speed (ft/s)						
Percent Blockage						
Right turn flare (veh)						
Median type					None	
Median storage veh						
Upstream signal (ft)						
pX, platoon unblocked						
vC, conflicting volume	234				652	207
vC1, stage 1 conf vol						
vC2, stage 2 conf vol						
vCu, unblocked vol	234				652	207
tC, single (s)	4.1				6.4	6.2
tC, 2 stage (s)						
tF (s)	2.2				3.5	3.3
p0 queue free %	97				84	92
cM capacity (veh/h)	1334				420	834
<b>Direction, Lane #</b>	<b>EB 1</b>	<b>WB 1</b>	<b>SB 1</b>			
Volume Total	408	234	130			
Volume Left	38	0	65			
Volume Right	0	54	65			
cSH	1334	1700	559			
Volume to Capacity	0.03	0.14	0.23			
Queue Length 95th (ft)	2	0	22			
Control Delay (s)	1.0	0.0	13.4			
Lane LOS	A		B			
Approach Delay (s)	1.0	0.0	13.4			
Approach LOS			B			
<b>Intersection Summary</b>						
Average Delay			2.8			
Intersection Capacity Utilization		50.7%		ICU Level of Service	A	
Analysis Period (min)			15			

17: New Roadway & 13th Street



Movement	EBL	EBT	WBT	WBR	SBL	SBR
Lane Configurations		↕	↕		↕	
Sign Control		Free	Free		Stop	
Grade		0%	0%		0%	
Volume (veh/h)	20	380	180	30	15	35
Peak Hour Factor	0.92	0.92	0.92	0.92	0.92	0.92
Hourly flow rate (vph)	22	413	196	33	16	38
Pedestrians						
Lane Width (ft)						
Walking Speed (ft/s)						
Percent Blockage						
Right turn flare (veh)						
Median type						
Median storage veh						
Upstream signal (ft)						
pX, platoon unblocked						
vC, conflicting volume	228				668	212
vC1, stage 1 conf vol						
vC2, stage 2 conf vol						
vCu, unblocked vol	228				668	212
tC, single (s)	4.1				6.4	6.2
tC, 2 stage (s)						
tF (s)	2.2				3.5	3.3
p0 queue free %	98				96	95
cM capacity (veh/h)	1340				416	828
<b>Direction, Lane #</b>						
	EB 1	WB 1	SB 1			
Volume Total	435	228	54			
Volume Left	22	0	16			
Volume Right	0	33	38			
cSH	1340	1700	639			
Volume to Capacity	0.02	0.13	0.09			
Queue Length 95th (ft)	1	0	7			
Control Delay (s)	0.5	0.0	11.2			
Lane LOS	A		B			
Approach Delay (s)	0.5	0.0	11.2			
Approach LOS			B			
<b>Intersection Summary</b>						
Average Delay			1.2			
Intersection Capacity Utilization		47.5%		ICU Level of Service		A
Analysis Period (min)			15			

18: New Roadway & 7th Street

												
Movement	EBL	EBT	EBR	WBL	WBT	WBR	NBL	NBT	NBR	SBL	SBT	SBR
Lane Configurations		↕			↕			↕			↕	
Sign Control		Free			Free			Stop			Stop	
Grade		0%			0%			0%			0%	
Volume (veh/h)	40	350	5	5	180	20	5	5	5	30	5	25
Peak Hour Factor	0.92	0.92	0.92	0.92	0.92	0.92	0.92	0.92	0.92	0.92	0.92	0.92
Hourly flow rate (vph)	43	380	5	5	196	22	5	5	5	33	5	27
Pedestrians												
Lane Width (ft)												
Walking Speed (ft/s)												
Percent Blockage												
Right turn flare (veh)												
Median type								None			None	
Median storage veh												
Upstream signal (ft)												
pX, platoon unblocked												
vC, conflicting volume	217			386			717	698	383	696	690	207
vC1, stage 1 conf vol												
vC2, stage 2 conf vol												
vCu, unblocked vol	217			386			717	698	383	696	690	207
tC, single (s)	4.1			4.1			7.1	6.5	6.2	7.1	6.5	6.2
tC, 2 stage (s)												
tF (s)	2.2			2.2			3.5	4.0	3.3	3.5	4.0	3.3
p0 queue free %	97			100			98	98	99	90	98	97
cM capacity (veh/h)	1352			1173			320	351	664	339	355	834
<b>Direction, Lane #</b>	<b>EB 1</b>	<b>WB 1</b>	<b>NB 1</b>	<b>SB 1</b>								
Volume Total	429	223	16	65								
Volume Left	43	5	5	33								
Volume Right	5	22	5	27								
cSH	1352	1173	401	453								
Volume to Capacity	0.03	0.00	0.04	0.14								
Queue Length 95th (ft)	2	0	3	12								
Control Delay (s)	1.1	0.2	14.4	14.3								
Lane LOS	A	A	B	B								
Approach Delay (s)	1.1	0.2	14.4	14.3								
Approach LOS			B	B								
<b>Intersection Summary</b>												
Average Delay			2.3									
Intersection Capacity Utilization		49.4%			ICU Level of Service				A			
Analysis Period (min)			15									





**APPENDIX SECTION B-6**

**Volumes and 2042 Operations**



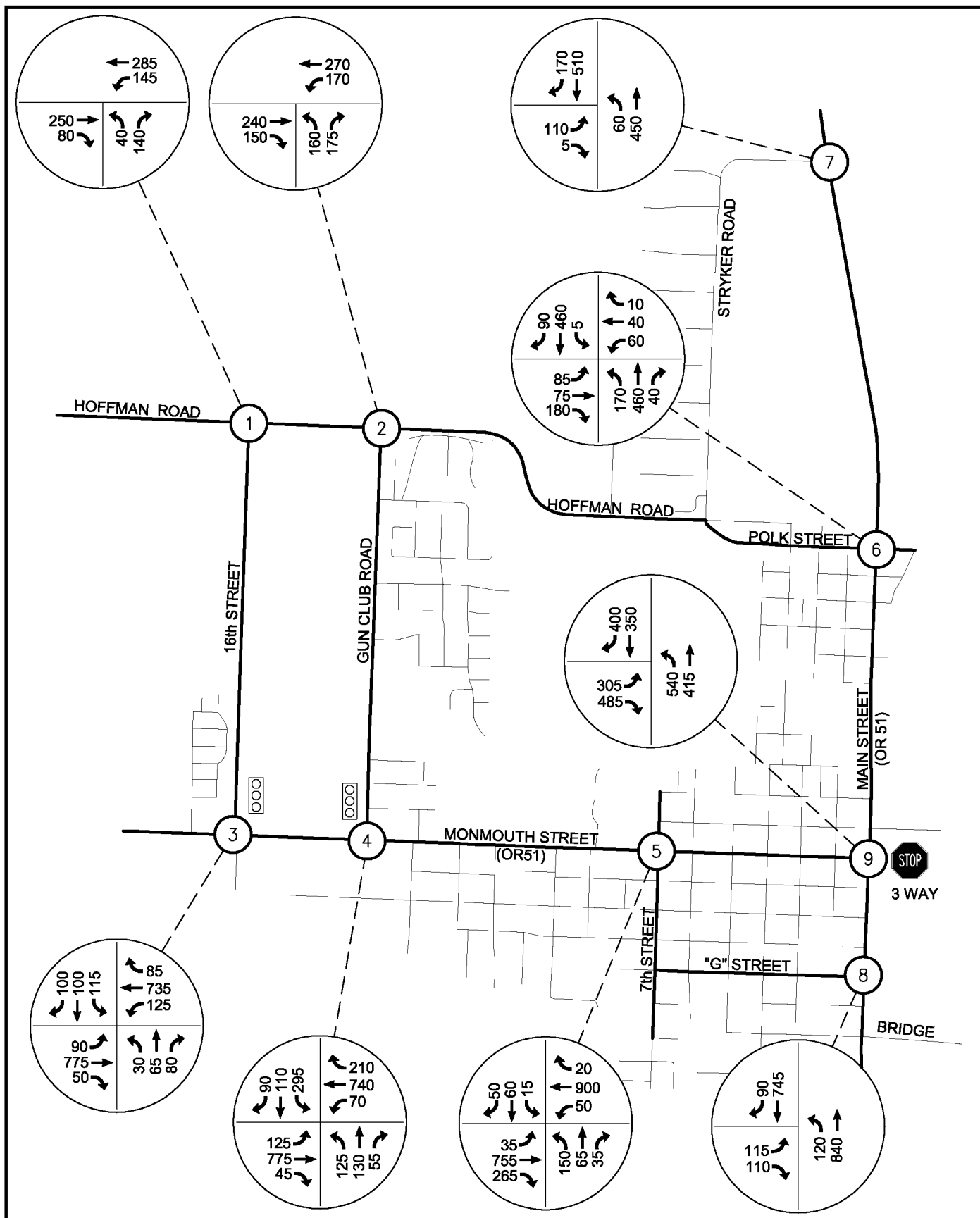

Parametrix DATE: Mar 30, 2007 FILE: PO2396051P05F-06



**LEGEND**







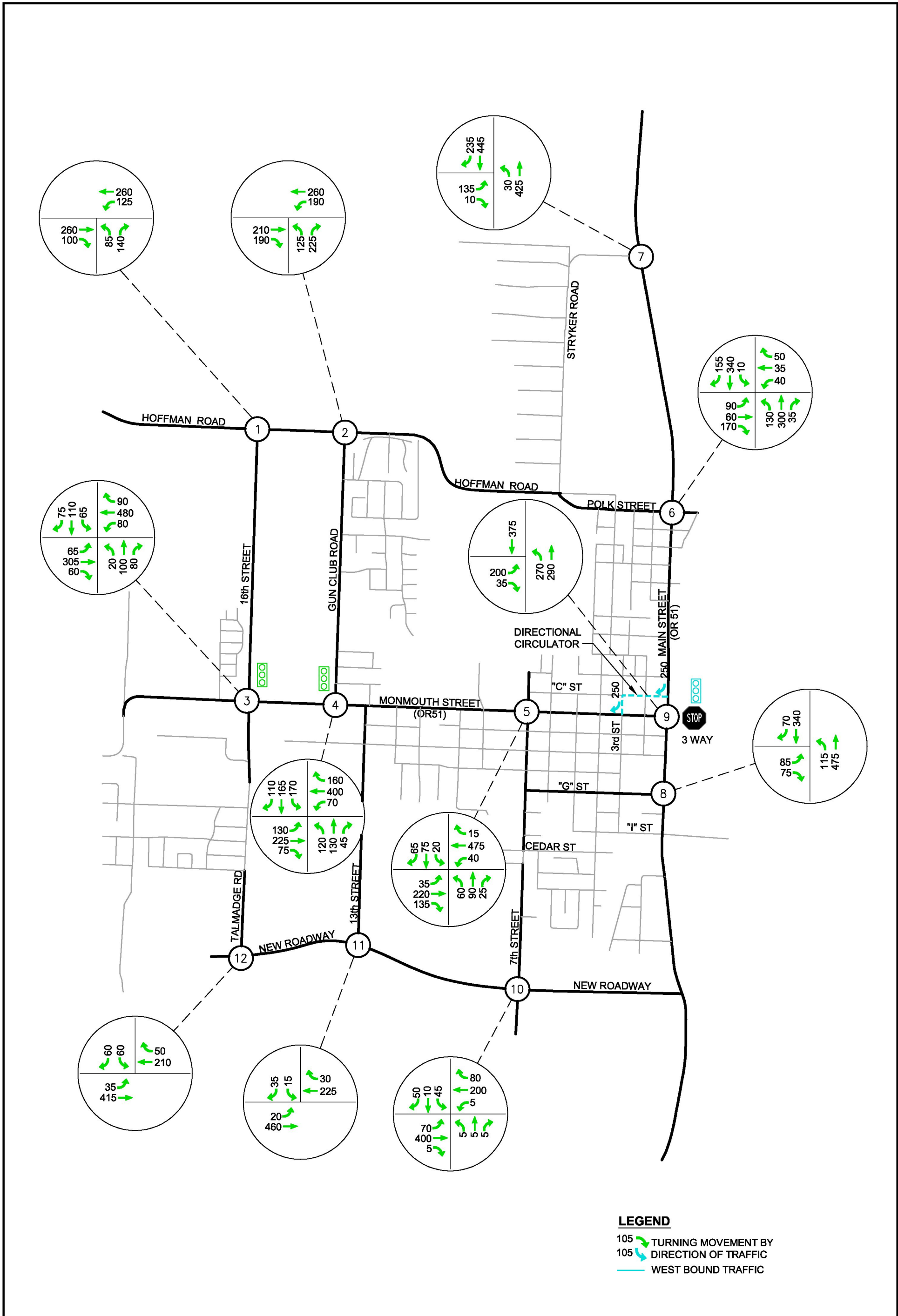













↪ 105 TURNING MOVEMENT BY DIRECTION OF TRAFFIC

**Alternative 3:  
Full UGB Build-Out (2042)  
Without Improvements**

INDEPENDENCE, OREGON























1: Hwy 51 & 16th Street

												
Movement	EBL	EBT	EBR	WBL	WBT	WBR	NBL	NBT	NBR	SBL	SBT	SBR
Lane Configurations												
Ideal Flow (vphpl)	1800	1800	1800	1800	1800	1800	1800	1800	1800	1800	1800	1800
Total Lost time (s)	4.0	4.0		4.0	4.0		4.0	4.0		4.0	4.0	
Lane Util. Factor	1.00	1.00		1.00	1.00		1.00	1.00		1.00	1.00	
Frt	1.00	0.99		1.00	0.98		1.00	0.92		1.00	0.93	
Flt Protected	0.95	1.00		0.95	1.00		0.95	1.00		0.95	1.00	
Satd. Flow (prot)	1676	1749		1676	1737		1676	1619		1676	1632	
Flt Permitted	0.95	1.00		0.95	1.00		0.49	1.00		0.59	1.00	
Satd. Flow (perm)	1676	1749		1676	1737		865	1619		1041	1632	
Volume (vph)	90	775	50	125	735	85	30	65	80	115	100	100
Peak-hour factor, PHF	0.92	0.92	0.92	0.92	0.92	0.92	0.92	0.92	0.92	0.92	0.92	0.92
Adj. Flow (vph)	98	842	54	136	799	92	33	71	87	125	109	109
RTOR Reduction (vph)	0	2	0	0	5	0	0	46	0	0	38	0
Lane Group Flow (vph)	98	894	0	136	886	0	33	112	0	125	180	0
Turn Type	Prot		Prot		Perm		Perm		Perm		Perm	
Protected Phases	5	2		1	6			8				4
Permitted Phases							8				4	
Actuated Green, G (s)	17.0	40.0		17.0	40.0		26.0	26.0		26.0	26.0	
Effective Green, g (s)	17.0	40.0		17.0	40.0		26.0	26.0		26.0	26.0	
Actuated g/C Ratio	0.18	0.42		0.18	0.42		0.27	0.27		0.27	0.27	
Clearance Time (s)	4.0	4.0		4.0	4.0		4.0	4.0		4.0	4.0	
Lane Grp Cap (vph)	300	736		300	731		237	443		285	447	
v/s Ratio Prot	0.06	0.51		c0.08	c0.51			0.10			c0.13	
v/s Ratio Perm							0.04			0.12		
v/c Ratio	0.33	1.21		0.45	1.21		0.14	0.25		0.44	0.40	
Uniform Delay, d1	34.0	27.5		34.8	27.5		26.1	26.9		28.5	28.2	
Progression Factor	1.00	1.00		0.63	1.32		1.00	1.00		1.00	1.00	
Incremental Delay, d2	2.9	108.7		0.4	96.9		1.2	1.4		4.8	2.7	
Delay (s)	36.9	136.2		22.6	133.2		27.3	28.3		33.3	30.9	
Level of Service	D	F		C	F		C	C		C	C	
Approach Delay (s)		126.4			118.6			28.1			31.8	
Approach LOS		F			F			C			C	
<b>Intersection Summary</b>												
HCM Average Control Delay		103.2					HCM Level of Service			F		
HCM Volume to Capacity ratio		0.83										
Actuated Cycle Length (s)		95.0		Sum of lost time (s)				12.0				
Intersection Capacity Utilization		82.4%		ICU Level of Service				E				
Analysis Period (min)		15										

c Critical Lane Group

2: Hwy 51 & Gun Club Road













												
Movement	EBL	EBT	EBR	WBL	WBT	WBR	NBL	NBT	NBR	SBL	SBT	SBR
Lane Configurations												
Ideal Flow (vphpl)	1800	1800	1800	1800	1800	1800	1800	1800	1800	1800	1800	1800
Total Lost time (s)	4.0	4.0		4.0	4.0		4.0	4.0			4.0	
Lane Util. Factor	1.00	1.00		1.00	1.00		1.00	1.00			1.00	
Frt	1.00	0.99		1.00	0.97		1.00	0.96			0.98	
Flt Protected	0.95	1.00		0.95	1.00		0.95	1.00			0.97	
Satd. Flow (prot)	1676	1750		1676	1706		1676	1686			1672	
Flt Permitted	0.95	1.00		0.95	1.00		0.58	1.00			0.58	
Satd. Flow (perm)	1676	1750		1676	1706		1021	1686			997	
Volume (vph)	125	775	45	70	740	210	125	130	55	295	110	90
Peak-hour factor, PHF	0.92	0.92	0.92	0.92	0.92	0.92	0.92	0.92	0.92	0.92	0.92	0.92
Adj. Flow (vph)	136	842	49	76	804	228	136	141	60	321	120	98
RTOR Reduction (vph)	0	2	0	0	11	0	0	16	0	0	9	0
Lane Group Flow (vph)	136	889	0	76	1021	0	136	185	0	0	530	0
Turn Type	Prot		Prot		Perm		Perm		Perm		Perm	
Protected Phases	5	2		1	6			8				4
Permitted Phases							8				4	
Actuated Green, G (s)	17.0	40.0		17.0	40.0		26.0	26.0			26.0	
Effective Green, g (s)	17.0	40.0		17.0	40.0		26.0	26.0			26.0	
Actuated g/C Ratio	0.18	0.42		0.18	0.42		0.27	0.27			0.27	
Clearance Time (s)	4.0	4.0		4.0	4.0		4.0	4.0			4.0	
Lane Grp Cap (vph)	300	737		300	718		279	461			273	
v/s Ratio Prot	c0.08	0.51		0.05	c0.60			0.11				
v/s Ratio Perm							0.13				c0.53	
v/c Ratio	0.45	1.21		0.25	1.42		0.49	0.40			1.94	
Uniform Delay, d1	34.8	27.5		33.5	27.5		28.9	28.1			34.5	
Progression Factor	1.08	0.91		1.00	1.00		1.00	1.00			1.00	
Incremental Delay, d2	0.4	93.9		2.0	198.0		6.0	2.6			437.3	
Delay (s)	38.0	119.0		35.6	225.5		34.9	30.7			471.8	
Level of Service	D	F		D	F		C	C			F	
Approach Delay (s)		108.3			212.5			32.4			471.8	
Approach LOS		F			F			C			F	
<b>Intersection Summary</b>												
HCM Average Control Delay		203.2					HCM Level of Service				F	
HCM Volume to Capacity ratio		1.39										
Actuated Cycle Length (s)		95.0					Sum of lost time (s)			12.0		
Intersection Capacity Utilization		115.1%					ICU Level of Service			H		
Analysis Period (min)		15										

c Critical Lane Group

4: Hwy 51 & Main Street







Movement	EBL	EBR	NBL	NBT	SBT	SBR
Lane Configurations	↘ ↙			↑	↓	↘ ↙
Sign Control	Stop			Stop	Stop	
Volume (vph)	305	485	540	415	350	400
Peak Hour Factor	0.92	0.92	0.92	0.92	0.92	0.92
Hourly flow rate (vph)	332	527	587	451	380	435
Direction, Lane #	EB 1	NB 1	SB 1			
Volume Total (vph)	859	1038	815			
Volume Left (vph)	332	587	0			
Volume Right (vph)	527	0	435			
Hadj (s)	-0.26	0.15	-0.29			
Departure Headway (s)	6.7	7.1	6.7			
Degree Utilization, x	1.60	2.06	1.52			
Capacity (veh/h)	540	513	542			
Control Delay (s)	298.7	498.9	260.6			
Approach Delay (s)	298.7	498.9	260.6			
Approach LOS	F	F	F			
Intersection Summary						
Delay			363.9			
HCM Level of Service			F			
Intersection Capacity Utilization			159.2%	ICU Level of Service	H	
Analysis Period (min)			15			

5: Polk Street & Main Street

												
Movement	EBL	EBT	EBR	WBL	WBT	WBR	NBL	NBT	NBR	SBL	SBT	SBR
Lane Configurations		↕			↕			↕			↕	
Sign Control		Stop			Stop			Free			Free	
Grade		0%			0%			0%			0%	
Volume (veh/h)	85	75	180	60	40	10	170	460	40	5	460	90
Peak Hour Factor	0.92	0.92	0.92	0.92	0.92	0.92	0.92	0.92	0.92	0.92	0.92	0.92
Hourly flow rate (vph)	92	82	196	65	43	11	185	500	43	5	500	98
Pedestrians												
Lane Width (ft)												
Walking Speed (ft/s)												
Percent Blockage												
Right turn flare (veh)												
Median type		None			None							
Median storage veh												
Upstream signal (ft)												
pX, platoon unblocked												
vC, conflicting volume	1484	1473	549	1688	1500	522	598			543		
vC1, stage 1 conf vol												
vC2, stage 2 conf vol												
vCu, unblocked vol	1484	1473	549	1688	1500	522	598			543		
tC, single (s)	7.1	6.5	6.2	7.1	6.5	6.2	4.1			4.1		
tC, 2 stage (s)												
tF (s)	3.5	4.0	3.3	3.5	4.0	3.3	2.2			2.2		
p0 queue free %	0	20	63	0	56	98	81			99		
cM capacity (veh/h)	57	102	536	14	98	555	979			1025		
<b>Direction, Lane #</b>	<b>EB 1</b>	<b>WB 1</b>	<b>NB 1</b>	<b>SB 1</b>								
Volume Total	370	120	728	603								
Volume Left	92	65	185	5								
Volume Right	196	11	43	98								
cSH	133	23	979	1025								
Volume to Capacity	2.78	5.12	0.19	0.01								
Queue Length 95th (ft)	842	Err	17	0								
Control Delay (s)	873.7	Err	4.4	0.1								
Lane LOS	F	F	A	A								
Approach Delay (s)	873.7	Err	4.4	0.1								
Approach LOS	F	F										
<b>Intersection Summary</b>												
Average Delay			835.8									
Intersection Capacity Utilization			101.3%		ICU Level of Service					G		
Analysis Period (min)			15									



6: Stryker Road & Main Street

Movement	EBL	EBR	NBL	NBT	SBT	SBR
Lane Configurations						
Sign Control	Stop			Free	Free	
Grade	0%			0%	0%	
Volume (veh/h)	110	5	60	450	510	170
Peak Hour Factor	0.92	0.92	0.92	0.92	0.92	0.92
Hourly flow rate (vph)	120	5	65	489	554	185
Pedestrians						
Lane Width (ft)						
Walking Speed (ft/s)						
Percent Blockage						
Right turn flare (veh)						
Median type	None					
Median storage veh						
Upstream signal (ft)						
pX, platoon unblocked						
vC, conflicting volume	1266	647	739			
vC1, stage 1 conf vol						
vC2, stage 2 conf vol						
vCu, unblocked vol	1266	647	739			
tC, single (s)	6.4	6.2	4.1			
tC, 2 stage (s)						
tF (s)	3.5	3.3	2.2			
p0 queue free %	31	99	92			
cM capacity (veh/h)	172	471	867			
Direction, Lane #	EB 1	NB 1	NB 2	SB 1		
Volume Total	125	65	489	739		
Volume Left	120	65	0	0		
Volume Right	5	0	0	185		
cSH	177	867	1700	1700		
Volume to Capacity	0.70	0.08	0.29	0.43		
Queue Length 95th (ft)	108	6	0	0		
Control Delay (s)	63.1	9.5	0.0	0.0		
Lane LOS	F	A				
Approach Delay (s)	63.1	1.1		0.0		
Approach LOS	F					
Intersection Summary						
Average Delay			6.0			
Intersection Capacity Utilization		59.5%		ICU Level of Service		B
Analysis Period (min)			15			



8: Hoffman Road & 16th Street

Movement	EBT	EBR	WBL	WBT	NBL	NBR
Lane Configurations	↔			↔		↔
Sign Control	Free			Free	Stop	
Grade	0%			0%	0%	
Volume (veh/h)	250	80	145	285	40	140
Peak Hour Factor	0.92	0.92	0.92	0.92	0.92	0.92
Hourly flow rate (vph)	272	87	158	310	43	152
Pedestrians						
Lane Width (ft)						
Walking Speed (ft/s)						
Percent Blockage						
Right turn flare (veh)						
Median type	None					
Median storage veh						
Upstream signal (ft)						
pX, platoon unblocked						
vC, conflicting volume			359		940	315
vC1, stage 1 conf vol						
vC2, stage 2 conf vol						
vCu, unblocked vol			359		940	315
tC, single (s)			4.1		6.4	6.2
tC, 2 stage (s)						
tF (s)			2.2		3.5	3.3
p0 queue free %			87		83	79
cM capacity (veh/h)			1200		254	725
<b>Direction, Lane #</b>	<b>EB 1</b>	<b>WB 1</b>	<b>NB 1</b>			
Volume Total	359	467	196			
Volume Left	0	158	43			
Volume Right	87	0	152			
cSH	1700	1200	514			
Volume to Capacity	0.21	0.13	0.38			
Queue Length 95th (ft)	0	11	44			
Control Delay (s)	0.0	3.8	16.3			
Lane LOS		A	C			
Approach Delay (s)	0.0	3.8	16.3			
Approach LOS			C			
<b>Intersection Summary</b>						
Average Delay			4.8			
Intersection Capacity Utilization			64.8%	ICU Level of Service	C	
Analysis Period (min)			15			













9: Hoffman Road & Gun Club Road

Movement	EBT	EBR	WBL	WBT	NBL	NBR
Lane Configurations	↗			↖		↘
Sign Control	Free			Free	Stop	
Grade	0%			0%	0%	
Volume (veh/h)	240	150	170	270	160	175
Peak Hour Factor	0.92	0.92	0.92	0.92	0.92	0.92
Hourly flow rate (vph)	261	163	185	293	174	190
Pedestrians						
Lane Width (ft)						
Walking Speed (ft/s)						
Percent Blockage						
Right turn flare (veh)						
Median type	None					
Median storage veh						
Upstream signal (ft)						
pX, platoon unblocked						
vC, conflicting volume			424		1005	342
vC1, stage 1 conf vol						
vC2, stage 2 conf vol						
vCu, unblocked vol			424		1005	342
tC, single (s)			4.1		6.4	6.2
tC, 2 stage (s)						
tF (s)			2.2		3.5	3.3
p0 queue free %			84		22	73
cM capacity (veh/h)			1135		224	700
<b>Direction, Lane #</b>	<b>EB 1</b>	<b>WB 1</b>	<b>NB 1</b>			
Volume Total	424	478	364			
Volume Left	0	185	174			
Volume Right	163	0	190			
cSH	1700	1135	347			
Volume to Capacity	0.25	0.16	1.05			
Queue Length 95th (ft)	0	15	319			
Control Delay (s)	0.0	4.5	96.9			
Lane LOS		A	F			
Approach Delay (s)	0.0	4.5	96.9			
Approach LOS			F			
<b>Intersection Summary</b>						
Average Delay			29.6			
Intersection Capacity Utilization			78.6%	ICU Level of Service	D	
Analysis Period (min)			15			

14: 'G' Street & Main Street

Movement	EBL	EBR	NBL	NBT	SBT	SBR
Lane Configurations						
Sign Control	Stop			Free	Free	
Grade	0%			0%	0%	
Volume (veh/h)	115	110	120	840	745	90
Peak Hour Factor	0.92	0.92	0.92	0.92	0.92	0.92
Hourly flow rate (vph)	125	120	130	913	810	98
Pedestrians						
Lane Width (ft)						
Walking Speed (ft/s)						
Percent Blockage						
Right turn flare (veh)						
Median type	None					
Median storage (veh)						
Upstream signal (ft)						
pX, platoon unblocked						
vC, conflicting volume	2033	859	908			
vC1, stage 1 conf vol						
vC2, stage 2 conf vol						
vCu, unblocked vol	2033	859	908			
tC, single (s)	6.4	6.2	4.1			
tC, 2 stage (s)						
tF (s)	3.5	3.3	2.2			
p0 queue free %	0	66	83			
cM capacity (veh/h)	52	356	750			
<b>Direction, Lane #</b>	<b>EB 1</b>	<b>NB 1</b>	<b>SB 1</b>			
Volume Total	245	1043	908			
Volume Left	125	130	0			
Volume Right	120	0	98			
cSH	89	750	1700			
Volume to Capacity	2.75	0.17	0.53			
Queue Length 95th (ft)	584	16	0			
Control Delay (s)	890.0	4.9	0.0			
Lane LOS	F	A				
Approach Delay (s)	890.0	4.9	0.0			
Approach LOS	F					
<b>Intersection Summary</b>						
Average Delay			101.5			
Intersection Capacity Utilization			124.7%	ICU Level of Service	H	
Analysis Period (min)			15			

15: Hwy 51 & 7th Street

												
Movement	EBL	EBT	EBR	WBL	WBT	WBR	NBL	NBT	NBR	SBL	SBT	SBR
Lane Configurations		↕			↕			↕			↕	
Sign Control		Free			Free			Stop			Stop	
Grade		0%			0%			0%			0%	
Volume (veh/h)	35	755	265	50	900	20	150	65	35	15	60	50
Peak Hour Factor	0.92	0.92	0.92	0.92	0.92	0.92	0.92	0.92	0.92	0.92	0.92	0.92
Hourly flow rate (vph)	38	821	288	54	978	22	163	71	38	16	65	54
Pedestrians												
Lane Width (ft)												
Walking Speed (ft/s)												
Percent Blockage												
Right turn flare (veh)												
Median type								None			None	
Median storage veh												
Upstream signal (ft)												
pX, platoon unblocked												
vC, conflicting volume	1000			1109			2226	2149	965	2212	2283	989
vC1, stage 1 conf vol												
vC2, stage 2 conf vol												
vCu, unblocked vol	1000			1109			2226	2149	965	2212	2283	989
tC, single (s)	4.1			4.1			7.1	6.5	6.2	7.1	6.5	6.2
tC, 2 stage (s)												
tF (s)	2.2			2.2			3.5	4.0	3.3	3.5	4.0	3.3
p0 queue free %	95			91			0	0	88	0	0	82
cM capacity (veh/h)	692			630			0	42	309	0	34	299
<b>Direction, Lane #</b>	<b>EB 1</b>	<b>WB 1</b>	<b>NB 1</b>	<b>SB 1</b>								
Volume Total	1147	1054	272	136								
Volume Left	38	54	163	16								
Volume Right	288	22	38	54								
cSH	692	630	0	0								
Volume to Capacity	0.05	0.09	Err	Err								
Queue Length 95th (ft)	4	7	Err	Err								
Control Delay (s)	2.0	2.8	Err	Err								
Lane LOS	A	A	F	F								
Approach Delay (s)	2.0	2.8	Err	Err								
Approach LOS			F	F								
<b>Intersection Summary</b>												
Average Delay			Err									
Intersection Capacity Utilization			101.5%		ICU Level of Service				G			
Analysis Period (min)			15									





















2042 with Arterial and Mitigation

1: Hwy 51 & 16th Street

Movement	EBL	EBT	EBR	WBL	WBT	WBR	NBL	NBT	NBR	SBL	SBT	SBR
Lane Configurations												
Ideal Flow (vphpl)	1800	1800	1800	1800	1800	1800	1800	1800	1800	1800	1800	1800
Total Lost time (s)	4.0	4.0		4.0	4.0		4.0	4.0		4.0	4.0	
Lane Util. Factor	1.00	1.00		1.00	1.00		1.00	1.00		1.00	1.00	
Frt	1.00	0.98		1.00	0.98		1.00	0.93		1.00	0.94	
Flt Protected	0.95	1.00		0.95	1.00		0.95	1.00		0.95	1.00	
Satd. Flow (prot)	1676	1721		1676	1723		1676	1647		1676	1657	
Flt Permitted	0.95	1.00		0.95	1.00		0.52	1.00		0.53	1.00	
Satd. Flow (perm)	1676	1721		1676	1723		911	1647		929	1657	
Volume (vph)	65	305	60	80	480	90	20	100	80	65	110	75
Peak-hour factor, PHF	0.92	0.92	0.92	0.92	0.92	0.92	0.92	0.92	0.92	0.92	0.92	0.92
Adj. Flow (vph)	71	332	65	87	522	98	22	109	87	71	120	82
RTOR Reduction (vph)	0	8	0	0	7	0	0	31	0	0	26	0
Lane Group Flow (vph)	71	389	0	87	613	0	22	165	0	71	176	0
Turn Type	Prot		Prot		Perm		Perm		Perm		Perm	
Protected Phases	5	2		1	6			8				4
Permitted Phases							8				4	
Actuated Green, G (s)	17.0	40.0		17.0	40.0		26.0	26.0		26.0	26.0	
Effective Green, g (s)	17.0	40.0		17.0	40.0		26.0	26.0		26.0	26.0	
Actuated g/C Ratio	0.18	0.42		0.18	0.42		0.27	0.27		0.27	0.27	
Clearance Time (s)	4.0	4.0		4.0	4.0		4.0	4.0		4.0	4.0	
Lane Grp Cap (vph)	300	725		300	725		249	451		254	453	
v/s Ratio Prot	0.04	0.23		c0.05	c0.36			0.12			c0.12	
v/s Ratio Perm							0.02			0.08		
v/c Ratio	0.24	0.54		0.29	0.85		0.09	0.37		0.28	0.39	
Uniform Delay, d1	33.4	20.6		33.8	24.7		25.7	27.9		27.1	28.0	
Progression Factor	1.00	1.00		0.88	1.21		1.00	1.00		1.00	1.00	
Incremental Delay, d2	1.9	2.8		1.5	7.7		0.7	2.3		2.7	2.5	
Delay (s)	35.3	23.4		31.2	37.5		26.4	30.2		29.9	30.5	
Level of Service	D	C		C	D		C	C		C	C	
Approach Delay (s)		25.2			36.7			29.8			30.4	
Approach LOS		C			D			C			C	
<b>Intersection Summary</b>												
HCM Average Control Delay			31.5			HCM Level of Service				C		
HCM Volume to Capacity ratio			0.61									
Actuated Cycle Length (s)			95.0			Sum of lost time (s)		12.0				
Intersection Capacity Utilization			64.1%			ICU Level of Service				C		
Analysis Period (min)			15									

c Critical Lane Group

2: Hwy 51 & Gun Club Road

												
Movement	EBL	EBT	EBR	WBL	WBT	WBR	NBL	NBT	NBR	SBL	SBT	SBR
Lane Configurations												
Ideal Flow (vphpl)	1800	1800	1800	1800	1800	1800	1800	1800	1800	1800	1800	1800
Total Lost time (s)	4.0	4.0		4.0	4.0		4.0	4.0		4.0	4.0	
Lane Util. Factor	1.00	1.00		1.00	1.00		1.00	1.00		1.00	1.00	
Frt	1.00	0.96		1.00	0.96		1.00	0.96		1.00	0.94	
Flt Protected	0.95	1.00		0.95	1.00		0.95	1.00		0.95	1.00	
Satd. Flow (prot)	1676	1698		1676	1689		1676	1696		1676	1658	
Flt Permitted	0.95	1.00		0.95	1.00		0.36	1.00		0.54	1.00	
Satd. Flow (perm)	1676	1698		1676	1689		637	1696		946	1658	
Volume (vph)	130	225	75	70	400	160	120	130	45	170	165	110
Peak-hour factor, PHF	0.92	0.92	0.92	0.92	0.92	0.92	0.92	0.92	0.92	0.92	0.92	0.92
Adj. Flow (vph)	141	245	82	76	435	174	130	141	49	185	179	120
RTOR Reduction (vph)	0	13	0	0	15	0	0	13	0	0	25	0
Lane Group Flow (vph)	141	314	0	76	594	0	130	177	0	185	274	0
Turn Type	Prot		Prot		Perm		Perm		Perm		Perm	
Protected Phases	5	2		1	6			8				4
Permitted Phases							8				4	
Actuated Green, G (s)	17.0	40.0		17.0	40.0		26.0	26.0		26.0	26.0	
Effective Green, g (s)	17.0	40.0		17.0	40.0		26.0	26.0		26.0	26.0	
Actuated g/C Ratio	0.18	0.42		0.18	0.42		0.27	0.27		0.27	0.27	
Clearance Time (s)	4.0	4.0		4.0	4.0		4.0	4.0		4.0	4.0	
Lane Grp Cap (vph)	300	715		300	711		174	464		259	454	
v/s Ratio Prot	c0.08	0.19		0.05	c0.36			0.11			0.18	
v/s Ratio Perm							c0.20			0.20		
v/c Ratio	0.47	0.44		0.25	0.84		0.75	0.38		0.71	0.60	
Uniform Delay, d1	35.0	19.5		33.5	24.6		31.5	28.0		31.1	30.0	
Progression Factor	1.08	0.79		1.00	1.00		1.00	1.00		1.00	1.00	
Incremental Delay, d2	4.7	1.7		2.0	11.2		25.0	2.4		15.5	5.8	
Delay (s)	42.4	17.2		35.6	35.7		56.5	30.3		46.7	35.8	
Level of Service	D	B		D	D		E	C		D	D	
Approach Delay (s)		24.8			35.7			41.0			40.0	
Approach LOS		C			D			D			D	
<b>Intersection Summary</b>												
HCM Average Control Delay			35.0			HCM Level of Service					D	
HCM Volume to Capacity ratio			0.74									
Actuated Cycle Length (s)			95.0			Sum of lost time (s)				12.0		
Intersection Capacity Utilization			76.7%			ICU Level of Service					D	
Analysis Period (min)			15									

















c Critical Lane Group

4: Hwy 51 & Main Street







Movement	EBL	EBR	NBL	NBT	SBT	SBR
Lane Configurations						
Ideal Flow (vphpl)	1800	1800	1800	1800	1800	1800
Total Lost time (s)	4.0			4.0	4.0	
Lane Util. Factor	1.00			1.00	1.00	
Frt	0.98			1.00	1.00	
Flt Protected	0.96			0.98	1.00	
Satd. Flow (prot)	1659			1723	1765	
Flt Permitted	0.96			0.62	1.00	
Satd. Flow (perm)	1659			1098	1765	
Volume (vph)	200	35	270	290	375	0
Peak-hour factor, PHF	0.92	0.92	0.92	0.92	0.92	0.92
Adj. Flow (vph)	217	38	293	315	408	0
RTOR Reduction (vph)	7	0	0	0	0	0
Lane Group Flow (vph)	248	0	0	608	408	0
Turn Type			pm+pt			
Protected Phases	4		5	2	6	
Permitted Phases			2			
Actuated Green, G (s)	14.3			51.9	51.9	
Effective Green, g (s)	14.3			51.9	51.9	
Actuated g/C Ratio	0.19			0.70	0.70	
Clearance Time (s)	4.0			4.0	4.0	
Vehicle Extension (s)	3.0			3.0	3.0	
Lane Grp Cap (vph)	320			768	1235	
v/s Ratio Prot	c0.15				0.23	
v/s Ratio Perm				c0.55		
v/c Ratio	0.77			0.79	0.33	
Uniform Delay, d1	28.4			7.5	4.4	
Progression Factor	1.00			1.00	1.00	
Incremental Delay, d2	11.1			5.6	0.2	
Delay (s)	39.5			13.1	4.5	
Level of Service	D			B	A	
Approach Delay (s)	39.5			13.1	4.5	
Approach LOS	D			B	A	
<b>Intersection Summary</b>						
HCM Average Control Delay			15.6		HCM Level of Service	B
HCM Volume to Capacity ratio			0.79			
Actuated Cycle Length (s)			74.2		Sum of lost time (s)	8.0
Intersection Capacity Utilization			76.7%		ICU Level of Service	D
Analysis Period (min)			15			
c Critical Lane Group						



5: Polk Street & Main Street

												
Movement	EBL	EBT	EBR	WBL	WBT	WBR	NBL	NBT	NBR	SBL	SBT	SBR
Lane Configurations												
Ideal Flow (vphpl)	1800	1800	1800	1800	1800	1800	1800	1800	1800	1800	1800	1800
Total Lost time (s)	4.0	4.0			4.0			4.0			4.0	
Lane Util. Factor	1.00	1.00			1.00			1.00			1.00	
Frt	1.00	0.89			0.95			0.99			0.96	
Flt Protected	0.95	1.00			0.98			0.99			1.00	
Satd. Flow (prot)	1676	1569			1643			1723			1690	
Flt Permitted	0.95	1.00			0.80			0.74			0.99	
Satd. Flow (perm)	1676	1569			1339			1292			1675	
Volume (vph)	90	60	170	40	35	50	130	300	35	10	340	155
Peak-hour factor, PHF	0.92	0.92	0.92	0.92	0.92	0.92	0.92	0.92	0.92	0.92	0.92	0.92
Adj. Flow (vph)	98	65	185	43	38	54	141	326	38	11	370	168
RTOR Reduction (vph)	0	117	0	0	28	0	0	3	0	0	16	0
Lane Group Flow (vph)	98	133	0	0	107	0	0	502	0	0	533	0
Turn Type	Split		Perm				Perm		Perm			
Protected Phases	4	4			8			2			6	
Permitted Phases				8			2			6		
Actuated Green, G (s)	10.4	10.4			8.8			37.1			37.1	
Effective Green, g (s)	10.4	10.4			8.8			37.1			37.1	
Actuated g/C Ratio	0.15	0.15			0.13			0.54			0.54	
Clearance Time (s)	4.0	4.0			4.0			4.0			4.0	
Vehicle Extension (s)	3.0	3.0			3.0			3.0			3.0	
Lane Grp Cap (vph)	255	239			173			702			910	
v/s Ratio Prot	0.06	c0.16										
v/s Ratio Perm					c0.10			c0.39			0.33	
v/c Ratio	0.38	0.56			0.62			0.71			0.59	
Uniform Delay, d1	26.1	26.8			28.2			11.6			10.4	
Progression Factor	1.00	1.00			1.00			1.00			1.00	
Incremental Delay, d2	1.0	2.8			6.5			3.5			1.0	
Delay (s)	27.0	29.6			34.6			15.1			11.4	
Level of Service	C	C			C			B			B	
Approach Delay (s)		28.9			34.6			15.1			11.4	
Approach LOS		C			C			B			B	
<b>Intersection Summary</b>												
HCM Average Control Delay			18.6									B
HCM Volume to Capacity ratio			0.79									
Actuated Cycle Length (s)			68.3						12.0			
Intersection Capacity Utilization			91.1%									F
Analysis Period (min)			15									
c Critical Lane Group												

6: Stryker Road & Main Street

Movement	EBL	EBR	NBL	NBT	SBT	SBR
Lane Configurations						
Sign Control	Stop			Free	Free	
Grade	0%			0%	0%	
Volume (veh/h)	135	10	30	425	445	235
Peak Hour Factor	0.92	0.92	0.92	0.92	0.92	0.92
Hourly flow rate (vph)	147	11	33	462	484	255
Pedestrians						
Lane Width (ft)						
Walking Speed (ft/s)						
Percent Blockage						
Right turn flare (veh)						
Median type	None					
Median storage veh						
Upstream signal (ft)						
pX, platoon unblocked						
vC, conflicting volume	1139	611	739			
vC1, stage 1 conf vol						
vC2, stage 2 conf vol						
vCu, unblocked vol	1139	611	739			
tC, single (s)	6.4	6.2	4.1			
tC, 2 stage (s)						
tF (s)	3.5	3.3	2.2			
p0 queue free %	32	98	96			
cM capacity (veh/h)	214	493	867			
Direction, Lane #	EB 1	NB 1	NB 2	SB 1		
Volume Total	158	33	462	739		
Volume Left	147	33	0	0		
Volume Right	11	0	0	255		
cSH	223	867	1700	1700		
Volume to Capacity	0.71	0.04	0.27	0.43		
Queue Length 95th (ft)	116	3	0	0		
Control Delay (s)	52.6	9.3	0.0	0.0		
Lane LOS	F	A				
Approach Delay (s)	52.6	0.6		0.0		
Approach LOS	F					
Intersection Summary						
Average Delay			6.2			
Intersection Capacity Utilization			55.0%		ICU Level of Service	B
Analysis Period (min)			15			

8: Hoffman Road & 16th Street

Movement	EBT	EBR	WBL	WBT	NBL	NBR
Lane Configurations	↔			↔	↔	↔
Sign Control	Free			Free	Stop	
Grade	0%			0%	0%	
Volume (veh/h)	260	100	125	260	85	140
Peak Hour Factor	0.92	0.92	0.92	0.92	0.92	0.92
Hourly flow rate (vph)	283	109	136	283	92	152
Pedestrians						
Lane Width (ft)						
Walking Speed (ft/s)						
Percent Blockage						
Right turn flare (veh)						
Median type	None					
Median storage (veh)						
Upstream signal (ft)						
pX, platoon unblocked						
vC, conflicting volume			391		891	337
vC1, stage 1 conf vol						
vC2, stage 2 conf vol						
vCu, unblocked vol			391		891	337
tC, single (s)			4.1		6.4	6.2
tC, 2 stage (s)						
tF (s)			2.2		3.5	3.3
p0 queue free %			88		67	78
cM capacity (veh/h)			1167		276	705
<b>Direction, Lane #</b>	<b>EB 1</b>	<b>WB 1</b>	<b>NB 1</b>	<b>NB 2</b>		
Volume Total	391	418	92	152		
Volume Left	0	136	92	0		
Volume Right	109	0	0	152		
cSH	1700	1167	276	705		
Volume to Capacity	0.23	0.12	0.33	0.22		
Queue Length 95th (ft)	0	10	35	20		
Control Delay (s)	0.0	3.6	24.4	11.5		
Lane LOS		A	C	B		
Approach Delay (s)	0.0	3.6	16.4			
Approach LOS			C			
<b>Intersection Summary</b>						
Average Delay			5.2			
Intersection Capacity Utilization			57.6%		ICU Level of Service	B
Analysis Period (min)			15			

















9: Hoffman Road & Gun Club Road

Movement	EBT	EBR	WBL	WBT	NBL	NBR
Lane Configurations	↗			↖	↖	↗
Sign Control	Free			Free	Stop	
Grade	0%			0%	0%	
Volume (veh/h)	210	190	190	260	125	225
Peak Hour Factor	0.92	0.92	0.92	0.92	0.92	0.92
Hourly flow rate (vph)	228	207	207	283	136	245
Pedestrians						
Lane Width (ft)						
Walking Speed (ft/s)						
Percent Blockage						
Right turn flare (veh)						
Median type				None		
Median storage veh						
Upstream signal (ft)						
pX, platoon unblocked						
vC, conflicting volume			435		1027	332
vC1, stage 1 conf vol						
vC2, stage 2 conf vol						
vCu, unblocked vol			435		1027	332
tC, single (s)			4.1		6.4	6.2
tC, 2 stage (s)						
tF (s)			2.2		3.5	3.3
p0 queue free %			82		36	66
cM capacity (veh/h)			1125		212	710
<b>Direction, Lane #</b>	<b>EB 1</b>	<b>WB 1</b>	<b>NB 1</b>	<b>NB 2</b>		
Volume Total	435	489	136	245		
Volume Left	0	207	136	0		
Volume Right	207	0	0	245		
cSH	1700	1125	212	710		
Volume to Capacity	0.26	0.18	0.64	0.34		
Queue Length (ft)	0	17	96	38		
Control Delay (s)	0.0	4.9	48.1	12.7		
Lane LOS		A	E	B		
Approach Delay (s)	0.0	4.9	25.3			
Approach LOS			D			
<b>Intersection Summary</b>						
Average Delay			9.2			
Intersection Capacity Utilization			66.8%		ICU Level of Service	C
Analysis Period (min)			15			

14: 'G' Street & Main Street

Movement	EBL	EBR	NBL	NBT	SBT	SBR
Lane Configurations						
Sign Control	Stop			Free	Free	
Grade	0%			0%	0%	
Volume (veh/h)	85	75	115	475	340	70
Peak Hour Factor	0.92	0.92	0.92	0.92	0.92	0.92
Hourly flow rate (vph)	92	82	125	516	370	76
Pedestrians						
Lane Width (ft)						
Walking Speed (ft/s)						
Percent Blockage						
Right turn flare (veh)						
Median type	None					
Median storage (veh)						
Upstream signal (ft)						
pX, platoon unblocked						
vC, conflicting volume	1174	408	446			
vC1, stage 1 conf vol						
vC2, stage 2 conf vol						
vCu, unblocked vol	1174	408	446			
tC, single (s)	6.4	6.2	4.1			
tC, 2 stage (s)						
tF (s)	3.5	3.3	2.2			
p0 queue free %	51	87	89			
cM capacity (veh/h)	188	644	1115			
Direction, Lane #	EB 1	EB 2	NB 1	SB 1		
Volume Total	92	82	641	446		
Volume Left	92	0	125	0		
Volume Right	0	82	0	76		
cSH	188	644	1115	1700		
Volume to Capacity	0.49	0.13	0.11	0.26		
Queue Length 95th (ft)	60	11	9	0		
Control Delay (s)	41.3	11.4	2.8	0.0		
Lane LOS	E	B	A			
Approach Delay (s)	27.3		2.8	0.0		
Approach LOS	D					
Intersection Summary						
Average Delay			5.2			
Intersection Capacity Utilization			71.4%		ICU Level of Service	C
Analysis Period (min)			15			

15: Hwy 51 & 7th Street

												
Movement	EBL	EBT	EBR	WBL	WBT	WBR	NBL	NBT	NBR	SBL	SBT	SBR
Lane Configurations												
Sign Control		Free			Free			Stop			Stop	
Grade		0%			0%			0%			0%	
Volume (veh/h)	35	220	135	40	475	15	60	90	25	20	75	65
Peak Hour Factor	0.92	0.92	0.92	0.92	0.92	0.92	0.92	0.92	0.92	0.92	0.92	0.92
Hourly flow rate (vph)	38	239	147	43	516	16	65	98	27	22	82	71
Pedestrians												
Lane Width (ft)												
Walking Speed (ft/s)												
Percent Blockage												
Right turn flare (veh)												
Median type								None			None	
Median storage veh												
Upstream signal (ft)												
pX, platoon unblocked												
vC, conflicting volume	533			386			1111	1008	312	1076	1073	524
vC1, stage 1 conf vol												
vC2, stage 2 conf vol												
vCu, unblocked vol	533			386			1111	1008	312	1076	1073	524
tC, single (s)	4.1			4.1			7.1	6.5	6.2	7.1	6.5	6.2
tC, 2 stage (s)												
tF (s)	2.2			2.2			3.5	4.0	3.3	3.5	4.0	3.3
p0 queue free %	96			96			39	56	96	82	60	87
cM capacity (veh/h)	1035			1173			106	223	728	118	204	553
<b>Direction, Lane #</b>	<b>EB 1</b>	<b>WB 1</b>	<b>NB 1</b>	<b>NB 2</b>	<b>SB 1</b>							
Volume Total	424	576	65	125	174							
Volume Left	38	43	65	0	22							
Volume Right	147	16	0	27	71							
cSH	1035	1173	106	263	245							
Volume to Capacity	0.04	0.04	0.61	0.48	0.71							
Queue Length (ft)	3	3	75	60	120							
Control Delay (s)	1.1	1.0	82.2	30.6	49.3							
Lane LOS	A	A	F	D	E							
Approach Delay (s)	1.1	1.0	48.3		49.3							
Approach LOS			E		E							
<b>Intersection Summary</b>												
Average Delay			13.8									
Intersection Capacity Utilization			62.4%		ICU Level of Service				B			
Analysis Period (min)			15									

16: New Roadway & Talmadge



Movement	EBL	EBT	WBT	WBR	SBL	SBR
Lane Configurations		↕	↕		↕	
Sign Control		Free	Free		Stop	
Grade		0%	0%		0%	
Volume (veh/h)	35	415	210	50	60	60
Peak Hour Factor	0.92	0.92	0.92	0.92	0.92	0.92
Hourly flow rate (vph)	38	451	228	54	65	65
Pedestrians						
Lane Width (ft)						
Walking Speed (ft/s)						
Percent Blockage						
Right turn flare (veh)						
Median type					None	
Median storage veh						
Upstream signal (ft)						
pX, platoon unblocked						
vC, conflicting volume	283				783	255
vC1, stage 1 conf vol						
vC2, stage 2 conf vol						
vCu, unblocked vol	283				783	255
tC, single (s)	4.1				6.4	6.2
tC, 2 stage (s)						
tF (s)	2.2				3.5	3.3
p0 queue free %	97				81	92
cM capacity (veh/h)	1280				352	783
<b>Direction, Lane #</b>	<b>EB 1</b>	<b>WB 1</b>	<b>SB 1</b>			
Volume Total	489	283	130			
Volume Left	38	0	65			
Volume Right	0	54	65			
cSH	1280	1700	486			
Volume to Capacity	0.03	0.17	0.27			
Queue Length (ft)	2	0	27			
Control Delay (s)	0.9	0.0	15.1			
Lane LOS	A		C			
Approach Delay (s)	0.9	0.0	15.1			
Approach LOS			C			
<b>Intersection Summary</b>						
Average Delay			2.7			
Intersection Capacity Utilization		57.4%		ICU Level of Service		B
Analysis Period (min)			15			



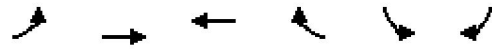









17: New Roadway & 13th Street



Movement	EBL	EBT	WBT	WBR	SBL	SBR
Lane Configurations		↕	↕		↕	
Sign Control		Free	Free		Stop	
Grade		0%	0%		0%	
Volume (veh/h)	20	460	225	30	15	35
Peak Hour Factor	0.92	0.92	0.92	0.92	0.92	0.92
Hourly flow rate (vph)	22	500	245	33	16	38
Pedestrians						
Lane Width (ft)						
Walking Speed (ft/s)						
Percent Blockage						
Right turn flare (veh)						
Median type					None	
Median storage veh						
Upstream signal (ft)						
pX, platoon unblocked						
vC, conflicting volume	277				804	261
vC1, stage 1 conf vol						
vC2, stage 2 conf vol						
vCu, unblocked vol	277				804	261
tC, single (s)	4.1				6.4	6.2
tC, 2 stage (s)						
tF (s)	2.2				3.5	3.3
p0 queue free %	98				95	95
cM capacity (veh/h)	1286				346	778
<b>Direction, Lane #</b>	<b>EB 1</b>	<b>WB 1</b>	<b>SB 1</b>			
Volume Total	522	277	54			
Volume Left	22	0	16			
Volume Right	0	33	38			
cSH	1286	1700	566			
Volume to Capacity	0.02	0.16	0.10			
Queue Length (ft)	1	0	8			
Control Delay (s)	0.5	0.0	12.0			
Lane LOS	A		B			
Approach Delay (s)	0.5	0.0	12.0			
Approach LOS			B			
<b>Intersection Summary</b>						
Average Delay			1.1			
Intersection Capacity Utilization		52.7%		ICU Level of Service		A
Analysis Period (min)			15			



18: New Roadway & 7th Street

												
Movement	EBL	EBT	EBR	WBL	WBT	WBR	NBL	NBT	NBR	SBL	SBT	SBR
Lane Configurations		↕			↕			↕			↕	
Sign Control		Free			Free			Stop			Stop	
Grade		0%			0%			0%			0%	
Volume (veh/h)	70	400	5	5	200	80	5	5	5	45	10	50
Peak Hour Factor	0.92	0.92	0.92	0.92	0.92	0.92	0.92	0.92	0.92	0.92	0.92	0.92
Hourly flow rate (vph)	76	435	5	5	217	87	5	5	5	49	11	54
Pedestrians												
Lane Width (ft)												
Walking Speed (ft/s)												
Percent Blockage												
Right turn flare (veh)												
Median type								None			None	
Median storage (veh)												
Upstream signal (ft)												
pX, platoon unblocked												
vC, conflicting volume	304			440			921	905	438	870	864	261
vC1, stage 1 conf vol												
vC2, stage 2 conf vol												
vCu, unblocked vol	304			440			921	905	438	870	864	261
tC, single (s)	4.1			4.1			7.1	6.5	6.2	7.1	6.5	6.2
tC, 2 stage (s)												
tF (s)	2.2			2.2			3.5	4.0	3.3	3.5	4.0	3.3
p0 queue free %	94			100			97	98	99	81	96	93
cM capacity (veh/h)	1256			1120			215	258	619	252	273	778
<b>Direction, Lane #</b>	<b>EB 1</b>	<b>WB 1</b>	<b>NB 1</b>	<b>SB 1</b>								
Volume Total	516	310	16	114								
Volume Left	76	5	5	49								
Volume Right	5	87	5	54								
cSH	1256	1120	296	376								
Volume to Capacity	0.06	0.00	0.06	0.30								
Queue Length (ft)	5	0	4	31								
Control Delay (s)	1.7	0.2	17.9	18.7								
Lane LOS	A	A	C	C								
Approach Delay (s)	1.7	0.2	17.9	18.7								
Approach LOS			C	C								
<b>Intersection Summary</b>												
Average Delay			3.5									
Intersection Capacity Utilization		62.5%		ICU Level of Service						B		
Analysis Period (min)		15										



**APPENDIX C**

**Proposed Revisions to City Code**



**M E M O R A N D U M**

Date: **June 5, 2007**  
To: **Independence City Council**  
From: **Michael Harrison, Project Manager**  
Subject: **Transportation System Plan Update**  
Project Number: **274-2395-051**  
Project Name: **Independence Transportation System Plan**

---

In 2006, the City of Independence was awarded a grant from the Transportation and Growth Management (TGM) Program, a joint program of the Oregon Department of Transportation and the Oregon Department of Land Conservation and Development, to partially fund an update to the City of Independence's 1998 Transportation System Plan (TSP). The State of Oregon Transportation Planning Rule (TPR) requires cities to prepare local TSPs which are consistent with regional system plans and the state system plan. The TPR also explains how local governments and ODOT should develop and coordinate transportation plans and how provision of transportation facilities and services is linked to land use planning.

To conform to the specific standards set forth in the TPR, it requires that the following topics be addressed:

- 1) Amend land use regulations to reflect and implement the TSP.
- 2) Adopt land use or subdivision ordinance measures, consistent with applicable state and federal requirements, to protect transportation facilities, corridors and sites for their identified functions, to cover the following topics:
  - Access management and control;
  - Protection of public use airports;
  - Coordinated review of land use decisions that might affect transportation facilities;
  - Conditions to minimize development impacts to transportation facilities;
  - Regulations to provide notice to public agencies providing transportation facilities and services of land use applications that might affect transportation facilities; and
  - Regulations assuring that amendment to land use applications, densities, and design standards are consistent with the TSP.
- 3) Adopt land use or subdivision regulations for urban areas and rural communities to provide safe and convenient pedestrian and bicycle circulation and bicycle parking, and to ensure that new development provides on-site streets and accessways that provide reasonably direct routes for pedestrian and bicycle travel.
- 4) Establish street standards that minimize pavement width and total right-of-way.

Independence City Council  
June 5, 2007

The City of Independence has reviewed its land use regulations and determined that amendments to the City of Independence Development Code are necessary not only for compliance with the TPR, but also to ensure consistency between the TSP and the Development Code. Some of the proposed changes are not specifically required by the TPR, but are included to better represent the "intent" of the Rule and to create development patterns that facilitate multi-modal travel.

Attached please find a copy of proposed changes to the City of Independence's Development Codes (Subchapters 11, 12, 20-22, 30, 32, 40-42, 48, 50, 57, 73, 80 and 90). New language shown in **bold and underlined**. Language to be deleted is shown ~~struck through~~.

Please review the draft document. A public hearing is scheduled before the Planning Commission on June 4, 2007. A public hearing before the City Council is scheduled for June 12, 2007.

Changes to the City's Development Code include:

- Page 1 – Section 11.015 is amended to require additional notice of land use applications to state and local agencies.
- Page 2 – Section 12.025 is amended to clarify that no zone change may be approved by the Planning Commission or enacted by the City Council unless it conforms to the Transportation System Plan.
- Page 3 to 5 – Sections 20.015, 21.015, 22.015, 30.010, 32.010, 40.010, 41.010, 42.025, 48.025 and 50.010 are amended to make projects identified in the Transportation System Plan permitted uses in all land use zones.
- Page 6 – Section 73.020 was amended to allow up to 25% of required parking surface area to be used for transit oriented uses, such as carpool parking, park-and-ride parking and public transit stations and platforms.
- Page 7 – Section 80.30.005 was amended to require traffic impact analyses for all development permits and land use applications which generate a net increase of 200 or more vehicle trips per day or are likely to increase the V/C ratio or decrease the safety of a State transportation facility. This amendment also modified the required information to be contained in traffic impact analyses.
- Page 8 – Section 80.40 was amended to indicate when right-of-way improvements to the City street network and State highway system shall be required as a part of a land use approval process.
- Page 9 – Section 90.60.030 was amended to require traffic impact analyses for all subdivision and major partitioning applications which generate a net increase of 200 or more vehicle trips per day or are likely to increase the V/C ratio or decrease the safety of a State transportation facility. This amendment also modified the required information to be contained in traffic impact analyses.
- Pages 10 to 13 – Section 57.130 was eliminated and Section 90.90.010 was amended to revise the street standards to make them consistent with the updated TSP and to be consistent with ODOT's revised access standards.

Independence City Council  
June 5, 2007

11.015 General Provisions

C. Citizen and Agency Involvement. The City shall provide opportunities for public and agency input in the planning process. The City shall give notice to:

(1) the Oregon Department of Transportation (ODOT) regarding any proposed land use action within 250 feet of **, or affects private access to,** a State transportation facility.

(2) the public works department of any jurisdictions (for example, Polk County), when any action by the City could potentially affect another jurisdiction's transportation facilities.

**(3) ODOT, Polk County, and the City of Monmouth of any land use applications that require public hearings or subdivision and partition applications.**

**(4) Oregon Department of Aviation of applications within airport noise impact boundaries and imaginary surfaces that affect airport operations.**

Independence City Council  
June 5, 2007

12.025 Standards for Zone Changes

No zone change shall be approved by the Planning Commission or enacted by the City council unless it conforms to the Comprehensive Plan, **including the Transportation System Plan**, and at least one of the following standards is met:

- A. The zoning on the land for which the zone change is initiated is erroneous and the zone change would correct the error;
- B. Conditions in the neighborhood surrounding the land for which the zone change is initiated have changed to such a degree that the zoning is no longer appropriate and the zone change would conform to the new conditions of the neighborhood;
- C. There is a public need for land use of the kind for which the zone change is initiated and that public need can best be met by the zone change.



20.015 Permitted Uses

Within any RS Zone, no structure shall be used, constructed, erected, or altered and no lot shall be used or occupied for any purposes except the following:

E. Structure necessary for the City or for a public utility to provide service to the neighborhood in which it is located. Such structures shall include, but not be limited to the following:

5. Streets and sidewalks-;

6. **Projects identified in the Transportation System Plan.**

21.015 Permitted Uses

Within any RM Zone, no structure shall be used, constructed, or altered and no lot, tract, or parcel of land shall be used or occupied for any purposes except the following:

G. Structure necessary for the City or for a public utility to provide service to the neighborhood in which it is located. Such structures shall include, but not be limited to the following:

5. Streets and sidewalks-;

6. **Projects identified in the Transportation System Plan.**

22.015 Permitted Uses

Within any RH Zone, no structure shall be used, constructed, erected, or altered and no lot shall be used or occupied for any purposes except the following:

I. Structure necessary for the city or for a public utility to provide service to the neighborhood in which it is located. Such structure shall include, but not be limited to the following:

5. Streets and sidewalks-;

6. **Projects identified in the Transportation System Plan.**

30.010 Permitted Uses

Within any CO zones, no structure shall be used, constructed, erected, or altered and no lot shall be used or occupied for any purposes except the following:

K. Structure necessary for the city or for a public utility to provide service to the neighborhood in which it is located. Such structures shall include, but not be limited to the following:

5. Streets and sidewalks;

**6. Projects identified in the Transportation System Plan.**

32.010 Permitted Uses

Within any CR zone, the following uses shall be permitted:

G. Structure necessary for the city or for a public utility to provide service to the neighborhood in which it is located. Such structures shall include but not be limited to the following:

5. Streets and sidewalks;

**6. Projects identified in the Transportation System Plan.**

40.010 Permitted Uses

Within any IL zone, no structure shall be used, constructed, erected, or altered and no lot shall be used or occupied for any purposes except the following:

**U. Streets and sidewalks;**

**V. Projects identified in the Transportation System Plan.**

41.010 Permitted Uses

Within any IH zone, no structure shall be used, constructed, erected, or altered and no lot shall be used or occupied for any purposes except the following:

**Y. Streets and sidewalks;**

**Z. Projects identified in the Transportation System Plan.**

Independence City Council  
June 5, 2007

42.010 Permitted Uses

Within any IP zone, no structure shall be used, constructed, erected, or altered and no lot shall be used or occupied for any purposes except those uses listed in this section and found to be in conformance with the review procedures of section 42.045 and below:

**Q. Streets and sidewalks;**

**R. Projects identified in the Transportation System Plan.**

48.025 Permitted Uses.

The use of the land and buildings must be in compliance with the base zoning district as established by the Official City of Independence Zoning Map, and is further limited to the following permitted uses for the RSA Overlay Zone:

**C. Streets and sidewalks;**

**D. Projects identified in the Transportation System Plan.**

50.010 Permitted Uses

Within any PS zone, no structure shall be used, constructed, erected, or altered and no lot shall be used or occupied for any purposes except the following:

**O. Streets and sidewalks;**

**P. Projects identified in the Transportation System Plan.**

Independence City Council  
June 5, 2007

73.020 General Requirements for Parking and Loading Areas

**K. Up to a maximum 25% of required parking facilities for uses, structures, or parcels of land may be satisfied by creation and maintenance of a facility dedicated to transit oriented uses, such as carpool parking, park-and-ride parking and public transit stations and platforms.**

### 80.30 SITE DESIGN REVIEW APPLICATION REQUIREMENTS

80.30.005. Submission of documents. An applicant for a building or other permit who is subject to site design review shall submit to the City, in addition to the requirements of Subsection 90.40 of the Independence City Code, the information listed below. The applicant shall submit three copies each of the required site analysis diagram, site development plan and landscape plan unless authorized by the City to combine the required information into one plan. When a public hearing is required, one additional set shall be submitted which is of a size that is conveniently reproducible, not to exceed 11 inches by 18 inches.

**F. Traffic Impact Analysis – A traffic impact analysis report, prepared by an Oregon professional traffic engineer or an Oregon registered Professional Engineer with expertise in traffic engineering, shall be required for all development permits and land use applications which generate a net increase of 200 or more vehicle trips per day or are likely to increase the V/C ratio or decrease the safety of a State transportation facility. Traffic impact analysis reports shall include:**

**1. The total estimated vehicular, pedestrian, bicycle and other transit service trips to be generated from the proposed development;**

**2. The impact of the total estimated vehicular, pedestrian, bicycle and other transit service trips on the existing street, sidewalk, bicycle and other transit systems within the City; and**

**3. Identification of improvement necessary to mitigate the total impact from the proposed development as identified in item 2.”**

**F. G.** A non-refundable application fee as set by the city council.

**G. H.** Any other information reasonably required to achieve the intent of this subchapter, the city zoning regulations and the comprehensive plan.

**80.40 REVIEW CRITERIA AND STANDARDS**

The following standards shall be utilized in reviewing the plans, drawings, sketches and other documents required by this subchapter. These standards are intended to provide a frame of reference for the applicant in the development of site and building plans as well as a method of review for the city. These standards shall not be regarded as inflexible requirements. They are not intended to discourage creativity, invention and innovation.

C. Traffic, parking and circulation considerations. With respect to vehicular, bicycle, and pedestrian circulation, including walkways, interior drives and parking, special attention shall be given to the arrangement and relationships of buildings in terms of pedestrian accessibility, location and number of access points, general interior circulation, separation of pedestrian and vehicular traffic, and arrangement of parking areas that are safe and convenient and, insofar as practicable, do not detract from the design of proposed buildings and structures and the neighboring properties. Based on the anticipated vehicular, bicycle, and pedestrian traffic generated, consideration may need to be given to improvements to the right-of-way such as installation of lighting, signalization, turn lanes, paving, curbs, sidewalks, bikeways and other facilities required because of the increased **bicyclist and pedestrian** traffic generated by the development. **Right-of-way improvements shall be required if increased vehicular traffic generated by the development will cause streets within the City of Independence to exceed their V/C standards, as shown in the following two tables:**

<b>Maximum Volume to Capacity Ratios for City-owned Streets</b>	
<i>City-owned streets bounded by B Street to E Street and 2nd Street to Main Street</i>	<b><u>.95</u></b>
<i>City-owned streets outside of the area bounded by B Street to E Street and 2nd Street to Main Street</i>	<b><u>.80</u></b>

<b>Maximum Volume to Capacity Ratios for State-owned Streets</b>				
<b>Highway Category</b>	<b>STAs</b>	<b>Outside of STAs where posted speed &lt;= 35 mph, or a Designated UBA</b>	<b>Outside of STAs where speed &gt; 35 mph</b>	<b>Outside of STAs where speed limit &gt;= 45 mph</b>
<b><u>District / Local Interest Roads</u></b>	<b><u>0.95</u></b>	<b><u>0.90</u></b>	<b><u>0.85</u></b>	<b><u>0.80</u></b>

New streets built as a part of developments must be designed to meet the V/C standards in the tables above.

Subchapter 90.60 SUBDIVISIONS AND MAJOR PARTITIONING REGULATIONS

90.60.030 Tentative Plat, Information. The following information shall be shown on the tentative plat:

~~Y. Traffic Impact Analysis. Depending on the nature and scope of the proposed development, the City Manager or designee may require a traffic impact analysis report, prepared by a registered transportation engineer, including the following:~~

- ~~1. The total estimated vehicular, pedestrian, bicycle and other transit service trips to be generated from the proposed development;~~
- ~~2. The impact of the total estimated vehicular, pedestrian, bicycle and other transit service trips on the existing street, sidewalk, bicycle and other transit systems within the City; and~~
- ~~3. The estimated level of improvement necessary to mitigate the total impact from the proposed development as identified in item 2.~~

**Y. Traffic Impact Analysis – A traffic impact analysis report, prepared by an Oregon professional traffic engineer or an Oregon registered Professional Engineer with expertise in traffic engineering, shall be required for all subdivision and major partitioning applications which generate a net increase of 200 or more vehicle trips per day or are likely to increase the V/C ratio or decrease the safety of a State transportation facility. Traffic impact analysis reports shall include:**

- 1. The total estimated vehicular, pedestrian, bicycle and other transit service trips to be generated from the proposed development;**
- 2. The impact of the total estimated vehicular, pedestrian, bicycle and other transit service trips on the existing street, sidewalk, bicycle and other transit systems within the City; and**
- 3. Identification of improvement necessary to mitigate the total impact from the proposed development as identified in item 2.”**

90.90.010 Streets.

D. Street Standards:

Section	Type of Street	Right-of-Way Width	Paving Width	Sidewalk	Bicycle Facilities
A	Major Arterial	84 feet	60 feet	Yes	Bikelane
	Minor Arterial	66 feet	36 feet	Yes	Bikelane
B	Major Collector	66	36	Yes	Bikelane
	Minor Collector	66 feet	36 feet	Yes	Shared Roadway
C	Local residential streets serving more than 20 dwelling units	60 feet	36 feet	Yes	Shared roadway
D	Local streets and cul-de-sacs serving less than 20 dwelling units	50 feet	28 feet	Yes	Shared roadway
E	Circular end cul-de-sacs	112 feet	90 feet*	Yes	Shared roadway

**Independence Street Design Standards**

	Major Arterial Streets	Minor Arterial Streets	Collector Streets	Local Streets <sup>(1)</sup>
<b>Right-of-way width</b>	<b>84 feet<sup>(2)</sup></b>	<b>66 feet<sup>(2)</sup></b>	<b>66 feet<sup>(2)</sup></b>	<b>52 feet</b>
<b>Curb-to-curb width</b>	<b>60 feet</b>	<b>36 feet</b>	<b>36 feet</b>	<b>28 feet</b>
<b>Moving Lanes</b>	<b>2-4</b>	<b>2</b>	<b>2</b>	<b>2</b>
<b>Turn Lanes</b>	<b>(3)</b>	<b>(3)</b>	<b>(3)</b>	<b>0</b>
<b>Bike Lanes</b>	<b>2 @ 6'</b>	<b>2 @ 6'</b>	<b>(4)</b>	<b>Shared</b>
<b>Parking Lanes</b>	<b>(5)</b>	<b>(5)</b>	<b>(4)</b>	<b>2 sides</b>
<b>Sidewalks</b>	<b>2 @ 6'</b>	<b>2 @ 6'</b>	<b>2 @ 6'</b>	<b>2 @ 6'</b>
<b>Planting Strips<sup>(6)</sup></b>	<b>2 @ 6'</b>	<b>2 @ 6'</b>	<b>2 @ 5'</b>	<b>Allowed</b>

(1) The City may require up to 36 foot wide (60 foot right-of-way) Local Service streets in or along high density residential, industrial or commercially zoned areas, or those expected to exceed 400 ADT.

(2) Additional right-of-way and roadway improvements may be required at major intersections to provide for turn lanes.

(3) At all intersections where separate lanes are needed due to volume of turning movement activity.

(4) Collectors with < 2,000 ADT can accommodate on-street parking and shared use of road space by bicyclists and motor vehicles. These shared roadways will be designated with "sharrows." "Sharrows" are markings painted directly onto the road to promote the awareness that the road is a shared traffic lane to be used by both motorists and bicyclists. For collectors with > 2,000 ADT the city will study the need to eliminate on-street parking and provide bike lanes.

(5) The City of Independence may allow parking along sections of Major and Minor Arterial Streets, balancing the needs for accessibility to property, public safety, bicycle facilities, and roadway congestion. Parking allowances will be evaluated on an on-going basis as a part of roadway projects.

(6) Planting strips are encouraged, but not required, along Local Service streets. If built along Local Service streets, planting strips should be at least 4 feet wide, to accommodate tree plantings. In commercially zoned areas, the City may require wider sidewalks which encroach into the planting strip area.



57.130 Width of Sidewalks

All sidewalks hereafter constructed or repaired shall be of the following minimum width, exclusive of any curb:

A. ~~If within a C-2 commercial zone as defined by the zoning ordinance of this city, or adjacent any property owned, used or to be used for school or public education purposes—8 feet.~~

B. ~~Elsewhere—5 feet, except curb line walks shall be 5 feet, inclusive of curb surface. (Ordinance 927, Sec. 3.)~~

90.90.010 Streets

V. Access Management. New access to arterials and collectors shall be limited. Shared or consolidated access shall be required for development or land divisions adjacent to these facilities unless demonstrated to be unfeasible.

1. Number of Access Points. All proposed development shall have access to a public right-of-way. Spacing requirements for access points and intersections on arterials and collector streets shall be as shown in the following two tables:

Access Management Requirements Highway 51

			<b>Intersection</b>				Signal Spacing
			Public Road		Private Drive		
Functional Class	ODOT Category*	ODOT LOI**	Type	Spacing	Type	Spacing	
Arterial Hwy. 51	6	District	At-Grade	500-foot	Lt./Rt. Turns	150-foot	¼ mile

\*ODOT Category refers to Highway Access Management Categories established by the Oregon Department of Transportation to classify access management needs for state highways.

\*\*ODOT LOI refers to the "Level of Importance" classification system established by the Oregon Department of Transportation to prioritize highway improvement needs and define operational objectives for state highways.

**Access Management Spacing Standards for Private and Public Approaches on District Highways<sup>(1)(2)(3)(4)</sup> (OAR 734-051-0115) (Measurement is in Feet)\***

<b><u>Posted Speed<sup>(5)</sup></u></b>	<b><u>Urban**</u></b>	<b><u>STA</u></b>
55	700	
50	550	
40 & 45	500	
30 & 35	350	<u>(6)</u>
≤25	350	<u>(6)</u>

**NOTE: The numbers in superscript (1) refer to explanatory notes that follow Table 4.**

**\* Measurement of the approach road spacing is from center to center on the same side of the roadway.**

**\*\*These standards also apply to Commercial Centers.**

**Notes on Tables 4:**

**(1) These access management spacing standards are for unsignalized approaches only. Signal spacing standards supersede access management spacing standards for approaches.**

**(2) These access management spacing standards do not apply to approaches in existence prior to April 1, 2000 except as provided in OAR 734-051-0115(1)(c) and 734-051-0125(1)(c).**

**(3) For infill and redevelopment, see OAR 734-051-0135(4).**

**(4) For deviations to the designated access management spacing standards see OAR 734-051-0135.**

**(5) Posted (or Desirable) Speed: Posted speed can only be adjusted (up or down) after a speed study is conducted and that study determines the correct posted speed to be different than the current posted speed. In cases where actual speeds are suspected to be much higher than posted speeds, the Department reserves the right to adjust the access management spacing accordingly. A determination can be made to go to longer access management spacing standards as appropriate for a higher speed. A speed study will need to be conducted to determine the correct speed.**

**(6) Minimum access management spacing for public road approaches is the existing city block spacing or the city block spacing as identified in the local comprehensive plan. Public road connections are preferred over private driveways and in STAs driveways are discouraged. However, where driveways are allowed and where land use patterns permit, the minimum access management spacing for driveways is 175 feet (55 meters) or mid-block if the current city block spacing is less than 350 feet (110 meters).**

**M E M O R A N D U M**

Date: **December 8, 2006**  
To: **Michael Danko, City of Independence**  
**Matthew Crall, Department of Land Conservation and Development**  
From: **Michael Harrison**  
Subject: **Summary of December 6 Open House**  
cc: **Anne Sylvester**  
**Shelley Oylear**

Project Number: **274-2395-051**

Project Name: **Independence Transportation System Plan**

---

**Introduction**

The City of Independence hosted an open house meeting for the Independence Transportation System Plan (TSP) on December 6, 2006, from 4:00 PM – 6:00 PM. The open house was held at the Independence Library, at 2nd and Monmouth Street, in Independence. The meeting was attended by one member of the public. In addition, Independence Police Officer Carl Nightengale attended the meeting on behalf of the Independence Traffic Safety Committee. Officer Nightengale submitted a list of TSP suggestions on behalf of the Independence Traffic Safety Committee. The Traffic Safety Committee includes 5 citizen members. Chief Darrell Patterson of the Polk County Fire District #1 also attended and submitted written suggestions on behalf of his agency (see attached).

The open house was staffed by Mike Danko, City of Independence; Matthew Crall, Department of Land Conservation and Development; and Michael Harrison, Parametrix.

**Public Notice**

A variety of tools were used to encourage attendance at the open house. On November 22, a notice (see attached) advertising the open house was published in the Polk County Itemizer – Observer. On December 6, the Polk County Itemizer – Observer also ran a newspaper article (see attached) about the TSP, which included mention of the open house. In addition to the newspaper advertising, notice of the open house was included on the Independence Police Department reader board on Monmouth Street (Oregon 51), on the City of Independence web site and was discussed in person with the Independence Transportation Safety Committee.

**Meeting Format**

The primary purpose of the open house was to educate the public on the TSP work completed so far, the project schedule, and obtain feedback on the community's transportation priorities. The meeting was a true open house format, with no formal presentation.

The public was invited to view informational display boards, talk with staff and consultants, and provide input in conversation with project staff and via comment forms. The following boards were displayed at the open house (see attached):

- City of Independence Comprehensive Plan map
- Map of Traffic Analysis Zones used in the TSP study

- Matrix of recommended changes to the local Comprehensive Plan, Development Code and TSP based on local and state policies.

### **Public Input**

A comment form (see attached) was made available to the public, that requested those filling out the form to provide their "thoughts on the transportation problems facing the City of Independence and the solutions" they would like pursued. The comment form also asked the public to rate, on a scale from one to four, the quality of the information provided at the open house. The meeting attendees chose not to fill out the comment forms.

In addition to the comment form, staff used a flip chart to record public comments. The comments took the form of the following recommendations:

- Requiring students of Central High School to remain at school during the lunch period to avoid pedestrian / auto conflicts on Monmouth Street (Oregon 51)
- Constructing continuous bike routes
- Using advertising to lure more foot traffic to Main Street (Oregon 51) businesses
- Allowing electric carts on local streets in Independence to serve the aging population
- Improvements to transit, when population increases make improved transit feasible
- Installation of a warning light on Monmouth Street (Oregon 51), in front of the fire station
- Opposition to traffic islands on Monmouth Street (Oregon 51), out of concern of impacts to fire service

The project recommendations submitted by the Polk County Fire District and Independence Transportation Safety Committee are attached. Additional notes were hand written onto the Transportation Safety Committee's recommendation sheet at the open house (see attached), to clarify the comments.

### **Conclusion**

The comments gathered at the open house, whether provided in person or in writing, will be considered in the development of the TSP. Based on the comments, an issue of potential contention has been identified:

- Street width. The TSP Implementation Matrix recommends that street standards be modified to allow for narrower local streets. Comments have been received in opposition to that concept.

Based on the comments, the following was the most commonly cited transportation problem:

- Traffic conflicts related to high school student crossings of Monmouth Street (Oregon 51) during the lunch hour.

**Written Comments Submitted**

### Future Street Improvement needs:

Put priority on opening more alternatives for east/west traffic flow. Encourage the completion of the southern bypass.

Resolve the pedestrian issues in front of the High School.

Eliminate congestion around each school by working with the School District to provide adequate parking and drop off zones.

Improve railroad crossings at B Street, C Street, D Street, and E Street.

Widen 7<sup>th</sup> Street at Monmouth to allow a left hand turn lane.

Widen Monmouth Street at 7<sup>th</sup> Street to allow a left hand turn lane (this could be done by prohibiting parking on Monmouth Street.

Widen Monmouth Street from Ash Creek Bridge to 2<sup>nd</sup> Street to provide a center turn lane. This could be done by prohibiting parking on both sides of Monmouth Street.

Open I Street across the railroad tracks, this would open a new exit for the SW side of town and increase our east/west traffic flow pattern.

At Gun Club Road at Hoffman Road – widen the intersection and add a left turn lane.

Raise Gun Club Road Bridge or create additional water flow under the road there to allow Gun Club Road to remain open even during heavy rains.

Widen the entire length of Gun Club Road and then allow truck traffic on that road.

Add a pedestrian crossing at the Ash Creek Bridge on Gun Club Road allowing for the return of full width traffic lanes and the removal of the concrete barriers.

Widen Polk Street at North Main Street to allow greater radius for trucks turning onto Polk Street. Widening this intersection might also allow for a left turn lane on Polk St.

Signalize North Main at Polk Street.

Extend the North Main Street improvements south from Polk Street to the fill bridge.

Work with the state highway department to allow for a right turn slow down lane for south bound traffic on Highway 51 approaching Stryker Road.

Widen Polk Street from Walnut Street to North Main Street, include curbs and sidewalks.

Install curbs and sidewalks throughout the remainder of town to protect pedestrians.

submitted by chief Darrell Patterson  
Dec. 6, 2006



# City of Independence

240 MONMOUTH STREET, P.O. BOX 7, INDEPENDENCE, OREGON 97351

Telephone: (503) 838-1212 FAX: (503) 838-5548

## INDEPENDENCE TRAFFIC SAFETY COMMITTEE

December 6, 2006

Subject: Independence Transportation System Plan

The Traffic Safety Commission (TSC) Suggestions:

*(Jog in side walk creates blind spot)*

1. Improve the intersection at Hoffman Road and Gun Club Road.

With the present layout, it's extremely hard to see oncoming vehicles from Gun Club Road, and when turning onto Gun Club from Hoffman, it's difficult to see pedestrian crossings. This crosswalk is heavily used by children going to and from Ash Creek Middle School, and walkers and joggers. Needs a cooperative effort from Polk County and Independence.

2. The TSC would object to rolled curbs.

Rolled curbs mean no beauty strips, therefore street to sidewalk transition is immediate. The danger of hitting pedestrians is increased. With regular curbs, drivers are more conscious of where they park.

The curbs would make it easy to park on the sidewalk, hindering pedestrian access, and would be unsightly.

*→ Kansas strip*

3. The TSC would strenuously object to changes in the city code decreasing minimum street width. This would create even more traffic bottlenecks, and would increase crashes because of impatient drivers. Reducing street width is not a traffic calming device, as claimed by some.

*11<sup>th</sup> was narrow and a problem with parking on both sides*

4. Central High School needs major changes on Monmouth Street because of heavy vehicle traffic and pedestrians. Some suggestions: closed campus, pedestrian bridge, move the high school exit.

Carl Nightengale  
for the Traffic Safety Committee  
[cnightengale@ci.independence.or.us](mailto:cnightengale@ci.independence.or.us)

*→ More east to west arterials w/ in the City Limits.*

## **Open House Materials**



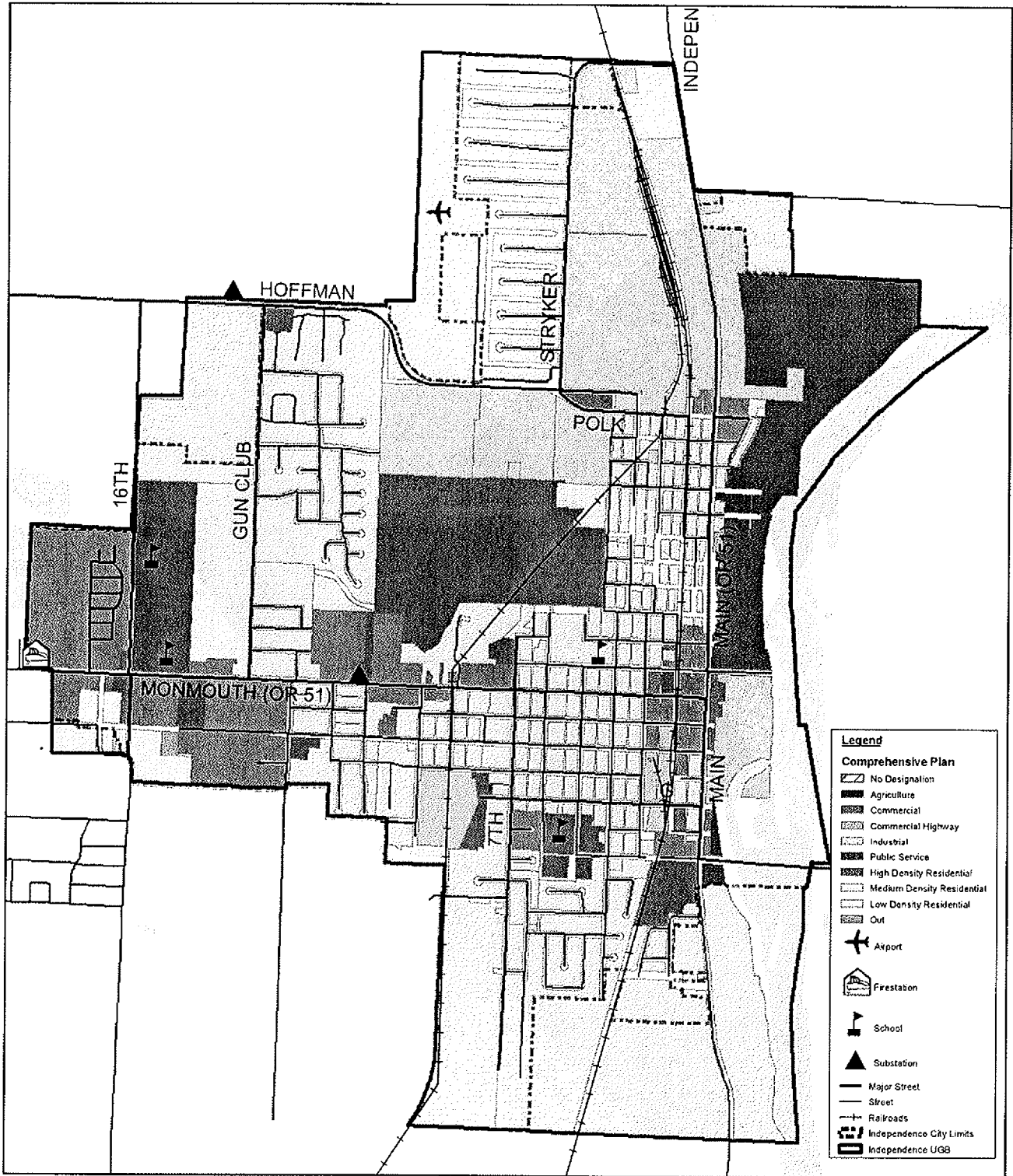

**Parametrix**

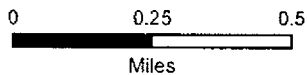

**Geographic Data Standards:**

Projected Coordinate System:  
NAD 1983 HARN StatePlane Oregon North

**Data Source(s):**

Mid-Willamette Valley Council of Governments  
Polk County GIS

Date: November 2006

*This product is for informational purposes and may not have been prepared for legal, engineering or surveying purposes. Users of this information should review or consult the primary data and information source to ascertain the usability of this information.*

**Figure 3-1  
Comprehensive Plan**

INDEPENDENCE TSP

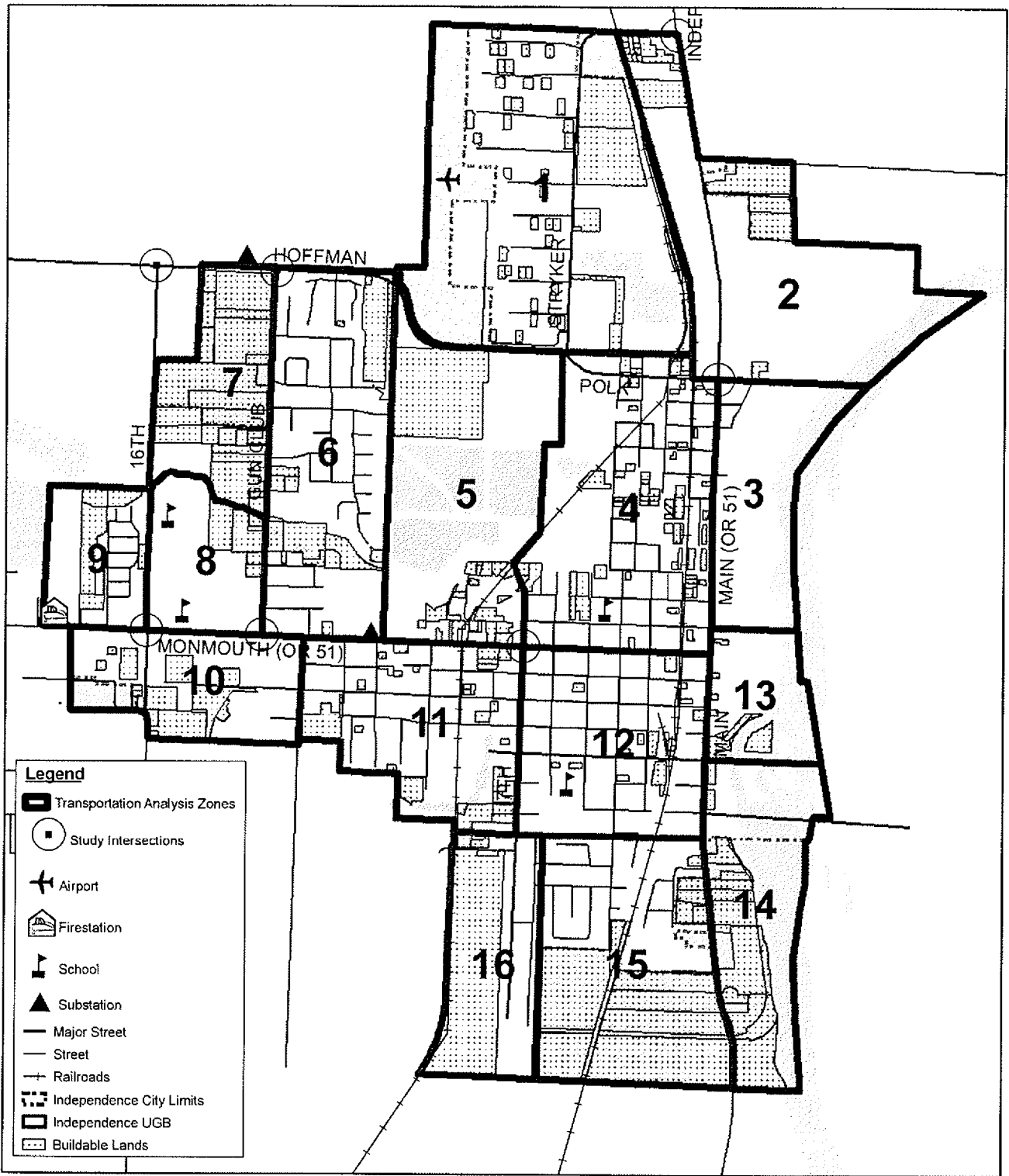

**Parametrix**

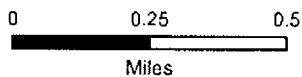

**Geographic Data Standards:**  
 Projected Coordinate System:  
 NAD 1983 HARN StatePlane Oregon North

**Data Source(s):**  
 Mid-Willamette Valley Council of Governments  
 Polk County GIS

Date: November 2006

*This product is for informational purposes and may not have been prepared for legal, engineering or surveying purposes. Users of this information should review or consult the primary data and information source to ascertain the usability of this information.*

**Figure 3-2  
 Traffic Analysis Zones**

INDEPENDENCE TSP

# City of Independence

## *Revised TSP Implementation Matrix*

Issue	Citation	Independence Development Code, Transportation System Plan and Comprehensive Plan
Land Use Approvals for Transportation Projects	TPR 045 (1)	DC 20.015, etc. – Not adequate
Access Control	TPR 045 (2) (a) OAR 734-051 OHP p. 103	DC 90.90.010 (V) – Adequate for municipal streets Not Adequate for OR 51
Protecting Future Operations	TPR 045 (2) (b) OHP p.30&79	DC 90.60.030 – Not Adequate
Airports	TPR 045 (2) (c) & OAR 660-013	DC Subchapters 48, 76 & 77– Adequate
Coordinated Review	TPR 045 (2) (d)	DC Subchapters 48, 76 & 77– Adequate for air Not Adequate for ground
Conditions of Approval	TPR 045 (2) (e)	DC 11.002, 11.015, 60.060 (D), 60.075, 90.10.030, 90.60.030 – Adequate, Possible Improvements
Notification	TPR 045 (2) (f)	DC 10.146 – Adequate
Consistency with TSP	TPR 045 (2) (g)	Numerous – Not Adequate
Bicycle Parking	TPR 045 (3) (a)	DC 73.025 (A) & (B) – Adequate
Pedestrian and Bicycle Facilities	TPR 045 (3) (b)	DC 80.30.005 (C) – Adequate for multi-family developments, planned developments, shopping centers, and commercial districts. Not Adequate for new subdivisions.
Off-site Improvements	TPR 045 (3) (c)	DC 90.90.010 – Adequate
Internal Pedestrian Circulation	TPR 045 (3) (e)	DC 80.30.005 (C) – Adequate
Design Support for Transit Routes and Transit Access	TPR 045 (4) (a), (b) & (e)	None – Not Adequate
Design Support for Transit Routes and Transit Access	TPR 045 (4) (c), (d), (f) & (g)	N.A.
Transit Oriented Development	TPR 045 (5) (a)	N.A.
Demand Management Program	TPR 045 (5) (b)	N.A.
Parking Plan	TPR 045 (5) (c)	N.A.
Pedestrian and Bicycle Plan for Developed Areas	TPR 045 (6)	TSP pgs. 90 & 91 – Not Adequate
Street Standards	TPR 045 (7)	DC 90.90.010 – Not Adequate
OHP Plan Policies	OHP p. 30	Numerous – Not Adequate

# City of Independence Transportation System Plan

Open House Comment Form  
December 6, 2006

## *Contact Information*

Name:

Address:

Phone:

Email:

Thank you for participating in the open house. In the space below and on the back of this form, please give us your thoughts on **the transportation problems facing the City of Independence and the solutions you would like us to pursue**. Please leave these forms with us today, so we can include your thoughts in the meeting summary.

How would you rate the information provided at the Open House?  
(1 = poor, 2 = average, 3 = good, 4 = excellent). Why?

**Newspaper Notices / Articles**

Polk County

# Itemizer-Observer

reflecting your life 

*November 22, 2006*

INDEPENDENCE -- An informal "open house" meeting for citizens to discuss updates to the local Transportation System Plan is set for 4 to 6 p.m. Wednesday, Dec. 6, at City Hall, 240 Monmouth St.

The plan establishes the city's short- and long-term transportation goals. For more information: 503-838-1212

Covering Monmouth, Dallas, Independence and Falls City since 1868

# Polk County Itemizer-Observer

reflecting your life



[Subscriptions](#)  
[Place Classified Ad](#)  
[Contact Polk County IO](#)  
[IO Home](#)

December 6, 2006

## News

# Independence drafts transportation plan

***INDEPENDENCE -- Independence leaders are drafting a master plan that will guide transportation development in the community for the next two decades.***

Local News

Features

Letters

Opinion

Obituaries

Column

[Election Results](#)

By **Craig Coleman**

INDEPENDENCE -- Independence leaders are drafting a master plan that will guide transportation development in the community for the next two decades.

Voice your opinion through our NEW online polls



**CLICK HERE**

Officials are revising the city's current plan through the growth management program of the Oregon Department of Land Conservation and Development (DLCD).

The agency awarded Independence a \$60,000 grant to fund the process this summer.

"Our focus is to link transportation with land use planning," said Matt Crall, a DLCD planner who is coordinating the initiative with the city. "You can't do one of those things separately from the other.

"We're trying to look 20 years out on the decisions we're making today."

The finished plan will consider growth trends and what long-term projects the transportation system needs to accommodate population increases.

This could range from street, sidewalk and bridge projects to railroad repairs, said Shawn Irvine, community development technician.

Officials are also seeking input from residents, and will hold open forums on the matter in the coming months.

The first is scheduled for 4 p.m. on Wednesday, Dec. 6, in the Independence Public Library.

"We want to review what we've talked about so far and hear about general issues the citizens think exist in Independence," Irvine said.

The \$60,000 DLCD grant has been used to contract a consultant to assist in revising the city's current plan, adopted in the mid-1990s.

Since September, the consultant and a technical advisory committee, comprised of city, county and state officials have been

## Sports

Sports Stories

Sports Briefs

Schedules

## Lifestyle

Entertainment

Connections

Agenda

Images of Polk

County

## Classifieds

[Daily Regional Ads](#)

[Place an Ad](#)

## Submit Information

[Letter to the Editor](#)

[News Tip](#)

- Community Event
- Engagement
- Wedding
- Anniversary
- Birth
- Business News
- List Your Business

updating information and language in the document.

"The anticipated population in the old plan was in the low-6,000 range and we're more than 1,000 people beyond that," Irvine said.

"And we've done a lot of the projects the old plan listed as infrastructure needs."

Another task is to make certain Independence policies comply with state and federal regulations. For example, the city uses a different standard to measure road quality than the state, Irvine said.

"Things like that make it harder to work with other agencies," Irvine said.

The committee will submit a draft of the document for review by the planning commission and city council during the next several months. There will be an additional open house next month and public hearings in May.

The council must adopt the plan by June 30, or risk waiting to receive funding from the state's next budget cycle to complete it.

For more information: Shawn Irvine or Mike Danko at 503-838-1212.

[Go to top.](#)

Webmaster Copyright Eagle Newspapers Inc., 2001 - 2006



**M E M O R A N D U M**

Date: **June 5, 2007**  
To: **Independence City Council**  
From: **Michael Harrison, Project Manager**  
Subject: **Transportation System Plan Update**  
Project Number: **274-2395-051**  
Project Name: **Independence Transportation System Plan**

---

In 2006, the City of Independence was awarded a grant from the Transportation and Growth Management (TGM) Program, a joint program of the Oregon Department of Transportation and the Oregon Department of Land Conservation and Development, to partially fund an update to the City of Independence's 1998 Transportation System Plan (TSP). The State of Oregon Transportation Planning Rule (TPR) requires cities to prepare local TSPs which are consistent with regional system plans and the state system plan. The TPR also explains how local governments and ODOT should develop and coordinate transportation plans and how provision of transportation facilities and services is linked to land use planning.

To conform to the specific standards set forth in the TPR, it requires that the following topics be addressed:

- 1) Amend land use regulations to reflect and implement the TSP.
- 2) Adopt land use or subdivision ordinance measures, consistent with applicable state and federal requirements, to protect transportation facilities, corridors and sites for their identified functions, to cover the following topics:
  - Access management and control;
  - Protection of public use airports;
  - Coordinated review of land use decisions that might affect transportation facilities;
  - Conditions to minimize development impacts to transportation facilities;
  - Regulations to provide notice to public agencies providing transportation facilities and services of land use applications that might affect transportation facilities; and
  - Regulations assuring that amendment to land use applications, densities, and design standards are consistent with the TSP.
- 3) Adopt land use or subdivision regulations for urban areas and rural communities to provide safe and convenient pedestrian and bicycle circulation and bicycle parking, and to ensure that new development provides on-site streets and accessways that provide reasonably direct routes for pedestrian and bicycle travel.
- 4) Establish street standards that minimize pavement width and total right-of-way.

The City of Independence has reviewed its land use regulations and determined that amendments to the City of Independence Development Code are necessary not only for compliance with the TPR, but also to ensure consistency between the TSP and the Development Code. Some of the proposed changes are not specifically required by the TPR, but are included to better represent the "intent" of the Rule and to create development patterns that facilitate multi-modal travel.

Attached please find a copy of proposed changes to the City of Independence's Development Codes (Subchapters 11, 12, 20-22, 30, 32, 40-42, 48, 50, 57, 73, 80 and 90). New language shown in **bold and underlined**. Language to be deleted is shown ~~struck through~~.

Please review the draft document. A public hearing is scheduled before the Planning Commission on June 4, 2007. A public hearing before the City Council is scheduled for June 12, 2007.

Changes to the City's Development Code include:

- Page 1 – Section 11.015 is amended to require additional notice of land use applications to state and local agencies.
- Page 2 – Section 12.025 is amended to clarify that no zone change may be approved by the Planning Commission or enacted by the City Council unless it conforms to the Transportation System Plan.
- Page 3 to 5 – Sections 20.015, 21.015, 22.015, 30.010, 32.010, 40.010, 41.010, 42.025, 48.025 and 50.010 are amended to make projects identified in the Transportation System Plan permitted uses in all land use zones.
- Page 6 – Section 73.020 was amended to allow up to 25% of required parking surface area to be used for transit oriented uses, such as carpool parking, park-and-ride parking and public transit stations and platforms.
- Page 7 – Section 80.30.005 was amended to require traffic impact analyses for all development permits and land use applications which generate a net increase of 200 or more vehicle trips per day or are likely to increase the V/C ratio or decrease the safety of a State transportation facility. This amendment also modified the required information to be contained in traffic impact analyses.
- Page 8 – Section 80.40 was amended to indicate when right-of-way improvements to the City street network and State highway system shall be required as a part of a land use approval process.
- Page 9 – Section 90.60.030 was amended to require traffic impact analyses for all subdivision and major partitioning applications which generate a net increase of 200 or more vehicle trips per day or are likely to increase the V/C ratio or decrease the safety of a State transportation facility. This amendment also modified the required information to be contained in traffic impact analyses.
- Pages 10 to 13 – Section 57.130 was eliminated and Section 90.90.010 was amended to revise the street standards to make them consistent with the updated TSP and to be consistent with ODOT's revised access standards.

#### 11.015 General Provisions

C. Citizen and Agency Involvement. The City shall provide opportunities for public and agency input in the planning process. The City shall give notice to:

(1) the Oregon Department of Transportation (ODOT) regarding any proposed land use action within 250 feet of, **or affects private access to,** a State transportation facility.

(2) the public works department of any jurisdictions (for example, Polk County), when any action by the City could potentially affect another jurisdiction's transportation facilities.

**(3) ODOT, Polk County, and the City of Monmouth of any land use applications that require public hearings or subdivision and partition applications.**

**(4) Oregon Department of Aviation of applications within airport noise impact boundaries and imaginary surfaces that affect airport operations.**

12.025 Standards for Zone Changes

No zone change shall be approved by the Planning Commission or enacted by the City council unless it conforms to the Comprehensive Plan, **including the Transportation System Plan**, and at least one of the following standards is met:

- A. The zoning on the land for which the zone change is initiated is erroneous and the zone change would correct the error;
- B. Conditions in the neighborhood surrounding the land for which the zone change is initiated have changed to such a degree that the zoning is no longer appropriate and the zone change would conform to the new conditions of the neighborhood;
- C. There is a public need for land use of the kind for which the zone change is initiated and that public need can best be met by the zone change.

20.015 Permitted Uses

Within any RS Zone, no structure shall be used, constructed, erected, or altered and no lot shall be used or occupied for any purposes except the following:

E. Structure necessary for the City or for a public utility to provide service to the neighborhood in which it is located. Such structures shall include, but not be limited to the following:

5. Streets and sidewalks-;

6. **Projects identified in the Transportation System Plan.**

21.015 Permitted Uses

Within any RM Zone, no structure shall be used, constructed, or altered and no lot, tract, or parcel of land shall be used or occupied for any purposes except the following:

G. Structure necessary for the City or for a public utility to provide service to the neighborhood in which it is located. Such structures shall include, but not be limited to the following:

5. Streets and sidewalks-;

6. **Projects identified in the Transportation System Plan.**

22.015 Permitted Uses

Within any RH Zone, no structure shall be used, constructed, erected, or altered and no lot shall be used or occupied for any purposes except the following:

I. Structure necessary for the city or for a public utility to provide service to the neighborhood in which it is located. Such structure shall include, but not be limited to the following:

5. Streets and sidewalks-;

6. **Projects identified in the Transportation System Plan.**

30.010 Permitted Uses

Within any CO zones, no structure shall be used, constructed, erected, or altered and no lot shall be used or occupied for any purposes except the following:

K. Structure necessary for the city or for a public utility to provide service to the neighborhood in which it is located. Such structures shall include, but not be limited to the following:

5. Streets and sidewalks;

**6. Projects identified in the Transportation System Plan.**

32.010 Permitted Uses

Within any CR zone, the following uses shall be permitted:

G. Structure necessary for the city or for a public utility to provide service to the neighborhood in which it is located. Such structures shall include but not be limited to the following:

5. Streets and sidewalks;

**6. Projects identified in the Transportation System Plan.**

40.010 Permitted Uses

Within any IL zone, no structure shall be used, constructed, erected, or altered and no lot shall be used or occupied for any purposes except the following:

**U. Streets and sidewalks;**

**V. Projects identified in the Transportation System Plan.**

41.010 Permitted Uses

Within any IH zone, no structure shall be used, constructed, erected, or altered and no lot shall be used or occupied for any purposes except the following:

**Y. Streets and sidewalks;**

**Z. Projects identified in the Transportation System Plan.**

42.010 Permitted Uses

Within any IP zone, no structure shall be used, constructed, erected, or altered and no lot shall be used or occupied for any purposes except those uses listed in this section and found to be in conformance with the review procedures of section 42.045 and below:

**Q. Streets and sidewalks;**

**R. Projects identified in the Transportation System Plan.**

48.025 Permitted Uses.

The use of the land and buildings must be in compliance with the base zoning district as established by the Official City of Independence Zoning Map, and is further limited to the following permitted uses for the RSA Overlay Zone:

**C. Streets and sidewalks;**

**D. Projects identified in the Transportation System Plan.**

50.010 Permitted Uses

Within any PS zone, no structure shall be used, constructed, erected, or altered and no lot shall be used or occupied for any purposes except the following:

**O. Streets and sidewalks;**

**P. Projects identified in the Transportation System Plan.**

73.020 General Requirements for Parking and Loading Areas

**K. Up to a maximum 25% of required parking facilities for uses, structures, or parcels of land may be satisfied by creation and maintenance of a facility dedicated to transit oriented uses, such as carpool parking, park-and-ride parking and public transit stations and platforms.**



## 80.30 SITE DESIGN REVIEW APPLICATION REQUIREMENTS

80.30.005. Submission of documents. An applicant for a building or other permit who is subject to site design review shall submit to the City, in addition to the requirements of Subsection 90.40 of the Independence City Code, the information listed below. The applicant shall submit three copies each of the required site analysis diagram, site development plan and landscape plan unless authorized by the City to combine the required information into one plan. When a public hearing is required, one additional set shall be submitted which is of a size that is conveniently reproducible, not to exceed 11 inches by 18 inches.

**F. Traffic Impact Analysis – A traffic impact analysis report, prepared by an Oregon professional traffic engineer or an Oregon registered Professional Engineer with expertise in traffic engineering, shall be required for all development permits and land use applications which generate a net increase of 200 or more vehicle trips per day or are likely to increase the V/C ratio or decrease the safety of a State transportation facility. Traffic impact analysis reports shall include:**

- 1. The total estimated vehicular, pedestrian, bicycle and other transit service trips to be generated from the proposed development;**
- 2. The impact of the total estimated vehicular, pedestrian, bicycle and other transit service trips on the existing street, sidewalk, bicycle and other transit systems within the City; and**
- 3. Identification of improvement necessary to mitigate the total impact from the proposed development as identified in item 2.”**

F **G.** A non-refundable application fee as set by the city council.

G. **H.** Any other information reasonably required to achieve the intent of this subchapter, the city zoning regulations and the comprehensive plan.

**80.40 REVIEW CRITERIA AND STANDARDS**

The following standards shall be utilized in reviewing the plans, drawings, sketches and other documents required by this subchapter. These standards are intended to provide a frame of reference for the applicant in the development of site and building plans as well as a method of review for the city. These standards shall not be regarded as inflexible requirements. They are not intended to discourage creativity, invention and innovation.

C. Traffic, parking and circulation considerations. With respect to vehicular, bicycle, and pedestrian circulation, including walkways, interior drives and parking, special attention shall be given to the arrangement and relationships of buildings in terms of pedestrian accessibility, location and number of access points, general interior circulation, separation of pedestrian and vehicular traffic, and arrangement of parking areas that are safe and convenient and, insofar as practicable, do not detract from the design of proposed buildings and structures and the neighboring properties. Based on the anticipated vehicular, bicycle, and pedestrian traffic generated, consideration may need to be given to improvements to the right-of-way such as installation of lighting, signalization, turn lanes, paving, curbs, sidewalks, bikeways and other facilities required because of the increased **bicyclist and pedestrian** traffic generated by the development. **Right-of-way improvements shall be required if increased vehicular traffic generated by the development will cause streets within the City of Independence to exceed their V/C standards, as shown in the following two tables:**

<b><u>Maximum Volume to Capacity Ratios for City-owned Streets</u></b>	
<i>City-owned streets bounded by B Street to E Street and 2nd Street to Main Street</i>	<b><u>.95</u></b>
<i>City-owned streets outside of the area bounded by B Street to E Street and 2nd Street to Main Street</i>	<b><u>.80</u></b>

<b><u>Maximum Volume to Capacity Ratios for State-owned Streets</u></b>				
<b><u>Highway Category</u></b>	<b><u>STAs</u></b>	<b><u>Outside of STAs where posted speed &lt;= 35 mph, or a Designated UBA</u></b>	<b><u>Outside of STAs where speed &gt; 35 mph</u></b>	<b><u>Outside of STAs where speed limit &gt; = 45 mph</u></b>
<b><u>District / Local Interest Roads</u></b>	<b><u>0.95</u></b>	<b><u>0.90</u></b>	<b><u>0.85</u></b>	<b><u>0.80</u></b>

New streets built as a part of developments must be designed to meet the V/C standards in the tables above.

Subchapter 90.60 SUBDIVISIONS AND MAJOR PARTITIONING REGULATIONS

90.60.030 Tentative Plat, Information. The following information shall be shown on the tentative plat:

~~Y. — Traffic Impact Analysis. Depending on the nature and scope of the proposed development, the City Manager or designee may require a traffic impact analysis report, prepared by a registered transportation engineer, including the following:~~

- ~~1. The total estimated vehicular, pedestrian, bicycle and other transit service trips to be generated from the proposed development;~~
- ~~2. The impact of the total estimated vehicular, pedestrian, bicycle and other transit service trips on the existing street, sidewalk, bicycle and other transit systems within the City; and~~
- ~~3. The estimated level of improvement necessary to mitigate the total impact from the proposed development as identified in item 2.~~

**Y. Traffic Impact Analysis – A traffic impact analysis report, prepared by an Oregon professional traffic engineer or an Oregon registered Professional Engineer with expertise in traffic engineering, shall be required for all subdivision and major partitioning applications which generate a net increase of 200 or more vehicle trips per day or are likely to increase the V/C ratio or decrease the safety of a State transportation facility. Traffic impact analysis reports shall include:**

- 1. The total estimated vehicular, pedestrian, bicycle and other transit service trips to be generated from the proposed development;**
- 2. The impact of the total estimated vehicular, pedestrian, bicycle and other transit service trips on the existing street, sidewalk, bicycle and other transit systems within the City; and**
- 3. Identification of improvement necessary to mitigate the total impact from the proposed development as identified in item 2.”**

90.90.010 Streets.

D. Street Standards:

<b>Section</b>	<b>Type of Street</b>	<b>Right-of-Way Width</b>	<b>Paving Width</b>	<b>Sidewalk</b>	<b>Bicycle Facilities</b>
A	Major Arterial	84 feet	60 feet	Yes	Bikelane
	Minor Arterial	66 feet	36 feet	Yes	Bikelane
B	Major Collector	66	36	Yes	Bikelane
	Minor Collector	66 feet	36 feet	Yes	Shared Roadway
C	Local residential streets serving more than 20 dwelling units	60 feet	36 feet	Yes	Shared roadway
D	Local streets and cul-de-sacs serving less than 20 dwelling units	50 feet	28 feet	Yes	Shared roadway
E	Circular and cul-de-sacs	112 feet	90 feet*	Yes	Shared roadway

**Independence Street Design Standards**

	<b><u>Major Arterial Streets</u></b>	<b><u>Minor Arterial Streets</u></b>	<b><u>Collector Streets</u></b>	<b><u>Local Streets<sup>(1)</sup></u></b>
<b><u>Right-of-way width</u></b>	<b><u>84 feet<sup>(2)</sup></u></b>	<b><u>66 feet<sup>(2)</sup></u></b>	<b><u>66 feet<sup>(2)</sup></u></b>	<b><u>52 feet</u></b>
<b><u>Curb-to-curb width</u></b>	<b><u>60 feet</u></b>	<b><u>36 feet</u></b>	<b><u>36 feet</u></b>	<b><u>28 feet</u></b>
<b><u>Moving Lanes</u></b>	<b><u>2-4</u></b>	<b><u>2</u></b>	<b><u>2</u></b>	<b><u>2</u></b>
<b><u>Turn Lanes</u></b>	<b><u>(3)</u></b>	<b><u>(3)</u></b>	<b><u>(3)</u></b>	<b><u>0</u></b>
<b><u>Bike Lanes</u></b>	<b><u>2 @ 6'</u></b>	<b><u>2 @ 6'</u></b>	<b><u>(4)</u></b>	<b><u>Shared</u></b>
<b><u>Parking Lanes</u></b>	<b><u>(5)</u></b>	<b><u>(5)</u></b>	<b><u>(4)</u></b>	<b><u>2 sides</u></b>
<b><u>Sidewalks</u></b>	<b><u>2 @ 6'</u></b>	<b><u>2 @ 6'</u></b>	<b><u>2 @ 6'</u></b>	<b><u>2 @ 6'</u></b>
<b><u>Planting Strips<sup>(6)</sup></u></b>	<b><u>2 @ 6'</u></b>	<b><u>2 @ 6'</u></b>	<b><u>2 @ 5'</u></b>	<b><u>Allowed</u></b>

(1) The City may require up to 36 foot wide (60 foot right-of-way) Local Service streets in or along high density residential, industrial or commercially zoned areas, or those expected to exceed 400 ADT.

(2) Additional right-of-way and roadway improvements may be required at major intersections to provide for turn lanes.

(3) At all intersections where separate lanes are needed due to volume of turning movement activity.

(4) Collectors with < 2,000 ADT can accommodate on-street parking and shared use of road space by bicyclists and motor vehicles. These shared roadways will be designated with "sharrows." "Sharrows" are markings painted directly onto the road to promote the awareness that the road is a shared traffic lane to be used by both motorists and bicyclists. For collectors with > 2,000 ADT the city will study the need to eliminate on-street parking and provide bike lanes.

(5) The City of Independence may allow parking along sections of Major and Minor Arterial Streets, balancing the needs for accessibility to property, public safety, bicycle facilities, and roadway congestion. Parking allowances will be evaluated on an on-going basis as a part of roadway projects.

(6) Planting strips are encouraged, but not required, along Local Service streets. If built along Local Service streets, planting strips should be at least 4 feet wide, to accommodate tree plantings. In commercially zoned areas, the City may require wider sidewalks which encroach into the planting strip area.

57.130 Width of Sidewalks

All sidewalks hereafter constructed or repaired shall be of the following minimum width, exclusive of any curb:

A. If within a C-2 commercial zone as defined by the zoning ordinance of this city, or adjacent any property owned, used or to be used for school or public education purposes — 8 feet.

B. Elsewhere — 5 feet, except curb line walks shall be 5 feet, inclusive of curb surface. (Ordinance 927, Sec. 3.)

90.90.010 Streets

V. Access Management. New access to arterials and collectors shall be limited. Shared or consolidated access shall be required for development or land divisions adjacent to these facilities unless demonstrated to be unfeasible.

1. Number of Access Points. All proposed development shall have access to a public right-of-way. Spacing requirements for access points and intersections on arterials and collector streets shall be as shown in the following two tables:

Access Management Requirements Highway 51

			<b>Intersection</b>				Signal Spacing
			Public Road		Private Drive		
Functional Class	ODOT Category*	ODOT LOI**	Type	Spacing	Type	Spacing	Signal Spacing
Arterial Hwy. 51	6	District	At Grade	500-foot	Lt./Rt. Turns	150-foot	¼ mile

\*-ODOT Category refers to Highway Access Management Categories established by the Oregon Department of Transportation to classify access management needs for state highways.

\*\* ODOT LOI refers to the "Level of Importance" classification system established by the Oregon Department of Transportation to prioritize highway improvement needs and define operational objectives for state highways.

**Access Management Spacing Standards for Private and Public Approaches on District Highways<sup>(1)(2)(3)(4)</sup> (OAR 734-051-0115) (Measurement is in Feet)\***

<u>Posted Speed<sup>(5)</sup></u>	<u>Urban**</u>	<u>STA</u>
55	700	
50	550	
40 & 45	500	
30 & 35	350	(6)
≤25	350	(6)

**NOTE:** The numbers in superscript (1) refer to explanatory notes that follow Table 4.

\* Measurement of the approach road spacing is from center to center on the same side of the roadway.

\*\*These standards also apply to Commercial Centers.

**Notes on Tables 4:**

(1) These access management spacing standards are for unsignalized approaches only. Signal spacing standards supersede access management spacing standards for approaches.

(2) These access management spacing standards do not apply to approaches in existence prior to April 1, 2000 except as provided in OAR 734-051-0115(1)(c) and 734-051-0125(1)(c).

(3) For infill and redevelopment, see OAR 734-051-0135(4).

(4) For deviations to the designated access management spacing standards see OAR 734-051-0135.

(5) Posted (or Desirable) Speed: Posted speed can only be adjusted (up or down) after a speed study is conducted and that study determines the correct posted speed to be different than the current posted speed. In cases where actual speeds are suspected to be much higher than posted speeds, the Department reserves the right to adjust the access management spacing accordingly. A determination can be made to go to longer access management spacing standards as appropriate for a higher speed. A speed study will need to be conducted to determine the correct speed.

(6) Minimum access management spacing for public road approaches is the existing city block spacing or the city block spacing as identified in the local comprehensive plan. Public road connections are preferred over private driveways and in STAs driveways are discouraged. However, where driveways are allowed and where land use patterns permit, the minimum access management spacing for driveways is 175 feet (55 meters) or mid-block if the current city block spacing is less than 350 feet (110 meters).

# City of Independence

## *Revised TSP Implementation Matrix*

<b>Issue</b>	<b>Citation</b>	<b>Independence Development Code, Transportation System Plan and Comprehensive Plan</b>
Land Use Approvals for Transportation Projects	TPR 045 (1)	DC 20.015, etc. – Not adequate
Access Control	TPR 045 (2) (a) OAR 734-051 OHP p. 103	DC 90.90.010 (V) – Adequate for municipal streets Not Adequate for OR 51
Protecting Future Operations	TPR 045 (2) (b) OHP p.30&79	DC 90.60.030 – Not Adequate
Airports	TPR 045 (2) (c) & OAR 660-013	DC Subchapters 48, 76 & 77– Adequate
Coordinated Review	TPR 045 (2) (d)	DC Subchapters 48, 76 & 77– Adequate for air Not Adequate for ground
Conditions of Approval	TPR 045 (2) (e)	DC 11.002, 11.015, 60.060 (D), 60.075, 90.10.030, 90.60.030 – Adequate, Possible Improvements
Notification	TPR 045 (2) (f)	DC 10.146 – Adequate
Consistency with TSP	TPR 045 (2) (g)	Numerous – Not Adequate
Bicycle Parking	TPR 045 (3) (a)	DC 73.025 (A) & (B) – Adequate
Pedestrian and Bicycle Facilities	TPR 045 (3) (b)	DC 80.30.005 (C) – Adequate for multi-family developments, planned developments, shopping centers, and commercial districts. Not Adequate for new subdivisions.
Off-site Improvements	TPR 045 (3) (c)	DC 90.90.010 – Adequate
Internal Pedestrian Circulation	TPR 045 (3) (e)	DC 80.30.005 (C) – Adequate
Design Support for Transit Routes and Transit Access	TPR 045 (4) (a), (b) & (e)	None – Not Adequate
Design Support for Transit Routes and Transit Access	TPR 045 (4) (c), (d), (f) & (g)	N.A.
Transit Oriented Development	TPR 045 (5) (a)	N.A.
Demand Management Program	TPR 045 (5) (b)	N.A.
Parking Plan	TPR 045 (5) (c)	N.A.
Pedestrian and Bicycle Plan for Developed Areas	TPR 045 (6)	TSP pgs. 90 & 91 – Not Adequate
Street Standards	TPR 045 (7)	DC 90.90.010 – Not Adequate
OHP Plan Policies	OHP p. 30	Numerous – Not Adequate

## Land Use Approvals for Transportation Projects

The TPR [660-12-045(1)] requires that local governments amend their land use regulations to implement their adopted TSP and to clarify the land use approval process for transportation-related projects. Independence specifically identifies some transportation projects as permitted in its Development Code. For example, streets and sidewalks are permitted in Single Family Residential (RS) Zones:

### 20.015 Permitted Uses

**Within any RS Zone, no structure shall be used, constructed, erected, or altered and no lot shall be used or occupied for any purposes except the following:**

**E. Structure necessary for the City or for a public utility to provide service to the neighborhood in which it is located. Such structures shall include, but not be limited to the following:**

#### **5. Streets and sidewalks.**

Similar language permits streets and sidewalks in all other residential and commercial zones, but is lacking in industrial and public services zones. Each zone should allow transportation improvements listed in the TSP as an allowed use. This section does not appear to meet the full intent of this TPR requirement.

### **Suggested Code Language**

Add the following sentence to the Development Code sections related to permitted uses for each zoning designation:

- “Transportation projects identified in the Transportation System Plan.”

## Access Control

The TPR [660-12-045(2)(a)] requires local governments to adopt access control measures, such as driveway and public road spacing, median control, and signal spacing standards that are consistent with the functional classification of roads. The Oregon Highway Plan OAR 734-051 includes access control standards for state roadways. Page 103 of the OHP requires local TSPs adopted after January 1, 2000, to be consistent with access management policies and OAR 734-051.

The Independence Development Code currently addresses access control in 90.90.010 (V):

### 90.90.010 Streets

**V. Access Management. New access to arterials and collectors shall be limited. Shared or consolidated access shall be required for development or land divisions adjacent to these facilities unless demonstrated to be unfeasible.**

- 1. Number of Access Points. All proposed development shall have access to a public right-of-way. Spacing requirements for access points and intersections on arterials and collector streets shall be as shown in the following two tables:**



### Access Management Requirements Highway 51

			Intersection				Signal
			Public Road		Private Drive		
Functional Class	ODOT Category*	ODOT LOI**	Type	Spacing	Type	Spacing	Spacing
Arterial Hwy. 51	6	District	At Grade	500 feet	Lt./Rt. Turns	150 feet	¼ mile

\* ODOT Category refers to Highway Access Management Categories established by the Oregon Department of Transportation to classify access management needs for state highways.

\*\* ODOT LOI refers to the "Level of Importance" classification system established by the Oregon Department of Transportation to prioritize highway improvement needs and define operational objectives for state highways.

### Access Management Requirements (City Streets)

Functional Class	Minimum Speed Posted	Minimum Spacing Between Driveways	Spacing Between Intersections
Major Arterial	35-50	250 feet	¼ mile
Minor Arterial	35-50	250 feet	250 feet
Major Collector	25-40	100-150 feet	250 feet
Collector	25-40	100-150 feet	250 feet

2. **The distance between access points shall be measured from the centerline of the proposed driveway or roadway to the centerline of the nearest adjacent roadway or driveway.**
3. **Frontage on Service Roads and Common Drives.**
  - a. **Projects proposed on arterials shall include a frontage or service road and shall take access from the frontage road rather than the arterial. Frontage road design shall conform to ODOT standards. This access requirement may be met through the use of interconnecting parking lots which abut the arterial.**
  - b. **Adjacent uses may share a common driveway provided that appropriate access easements are granted between and among property owners.**
4. **Alternative Designs. Where natural features or spacing of existing driveways and roadways cause the foregoing access requirements to be physically unfeasible, alternate designs may be approved.**
5. **Access to Residential Lots. All lots in a proposed residential subdivision shall have frontage on and access from a local or collector street.**

This section appears to meet the intent of the TPR and OHP access management guidance for municipal streets. To bring the access management requirements for OR 51 into compliance with OAR 734-051, Table 4 (below) should be substituted for the Access Management Requirements Highway 51 Table (above). Please note, OR 51 is a District Highway with STA and Commercial Center designations.

## Suggested Code Language

**Table 4. Access Management Spacing Standards for Private and Public Approaches on District Highways<sup>(1)(2)(3)(4)</sup> (OAR 734-051-0115) (Measurement is in Feet)\***

Posted Speed <sup>(5)</sup>	Urban**	STA
55	700	
50	550	
40 & 45	500	
30 & 35	350	(6)
≤25	350	(6)

NOTE: The numbers in superscript (1) refer to explanatory notes that follow Table 4.

\* Measurement of the approach road spacing is from center to center on the same side of the roadway.

\*\*These standards also apply to Commercial Centers.

### Notes on Tables 4:

(1) These access management spacing standards are for unsignalized approaches only. Signal spacing standards supersede access management spacing standards for approaches.

(2) These access management spacing standards do not apply to approaches in existence prior to April 1, 2000 except as provided in OAR 734-051-0115(1)(c) and 734-051-0125(1)(c).

(3) For infill and redevelopment, see OAR 734-051-0135(4).

(4) For deviations to the designated access management spacing standards see OAR 734-051-0135.

(5) Posted (or Desirable) Speed: Posted speed can only be adjusted (up or down) after a speed study is conducted and that study determines the correct posted speed to be different than the current posted speed. In cases where actual speeds are suspected to be much higher than posted speeds, the Department reserves the right to adjust the access management spacing accordingly. A determination can be made to go to longer access management spacing standards as appropriate for a higher speed. A speed study will need to be conducted to determine the correct speed.

(6) Minimum access management spacing for public road approaches is the existing city block spacing or the city block spacing as identified in the local comprehensive plan. Public road connections are preferred over private driveways and in STAs driveways are discouraged. However, where driveways are allowed and where land use patterns permit, the minimum access management spacing for driveways is 175 feet (55 meters) or mid-block if the current city block spacing is less than 350 feet (110 meters).

## **Protecting Future Operations**

The TPR [660-12-045(2)(b)] requires local governments to adopt standards to protect future operation of roads, transit ways and major transit corridors. The OHP similarly calls for the creation of performance standards to protect the mobility of state owned transportation facilities. These performance standards apply to TSP projects and amendments to TSPs, comprehensive plans and development codes.

While the Independence TSP includes level of service standards, the standard is not consistent with the ODOT preferred volume to capacity measure and the standard is not included in the Development Code. The Development Code also includes the following general guidance:

**90.60.030 Tentative Plat, Information. The following information shall be shown on the tentative plat:**

**Y. Traffic Impact Analysis.** Depending on the nature and scope of the proposed development, the City Manager or designee may require a traffic impact analysis report, prepared by a registered transportation engineer, including the following:

1. The total estimated vehicular, pedestrian, bicycle and other transit service trips to be generated from the proposed development;
2. The impact of the total estimated vehicular, pedestrian, bicycle and other transit service trips on the existing street, sidewalk, bicycle and other transit systems within the City; and
3. The estimated level of improvement necessary to mitigate the total impact from the proposed development as identified in item 2.

**Suggested Code Language**

To preserve infrastructure investments and ensure adequate capacity for new development, develop volume to capacity standards for signalized intersections and delay standards, in seconds and minutes and not with letter grade, for unsignalized intersections for municipal roads. Adopt the following OHP highway mobility standards for state highway facilities in Independence:

<b>Maximum Volume to Capacity Ratios Outside Metro *</b>				
<b>Highway Category</b>	STAs	Non-MPO Outside of STAs where non-freeway posted speed <= 35 mph, or a Designated UBA	Non-MPO outside of STAs where non-freeway speed > 35 mph	Non-MPO where non-freeway speed limit > = 45 mph
District / Local Interest Roads	0.95	0.90	0.85	0.80

\*National Highway System (NHS) highway design requirements are addressed in the Highway Design Manual (HDM)

Ensure that any new TSP projects for Independence comply with the relevant standards. This work to take place during the TSP update.

**Airports**

The TPR [660-12-045(2)(c)] requires local governments to adopt measures to control land uses within airport noise corridors and imaginary surfaces. In addition to the TPR requirements there are OAR requirements [660-013] that pertain to airport planning. OAR 660-013-0040 requires that local jurisdictions adopt a map showing the airport boundary, location of runways and other features and future areas of expansion.

The Independence Development Code adequately addresses these requirements in Subchapter 48: Residential Single Family Airpark Overlay (RSA) Zone, Subchapter 76: Airport Development District, and Subchapter 77: Airport Zone Height Limitations.

**Coordinated Review**

The TPR [660-12-045(2)(d)] requires local governments to create a process for coordinated review of future land use decisions affecting transportation facilities, corridors or sites. Subchapter 77 and 78 of the Independence Development Code provides guidance on coordinating with the FAA and Oregon Department of Aviation on land use actions which could potentially impact the Independence State Airport. However, similar guidance for ground transportation is lacking.

### **Suggested Code Language**

Referral agencies are those agencies notified of potential land use actions under 11.105 of the Independence Development Code. It is the responsibility of a referral agency to provide timely review and comment on all proposals referred by the City. The referral agency shall be requested to determine consistency of a proposal with the referral agency's operating policies and standards and to recommend conditions on development. The coordination in this section is in addition to the coordination requirements outlined in the Polk County – City of Independence Urban Growth Management Agreement.

### **Conditions of Approval**

The TPR [660-12-045(2)(e)] requires local governments to adopt land use regulations that create a process for applying conditions to development proposals to minimize impacts and protect transportation facilities, corridors, or sites. The Development Code includes the following guidance for conditions of approval:

#### **11.002 APPLICATION TYPES AND REVIEW PROCEDURES**

**All development permits and land use actions are processed under the City's administrative procedures. There are four types of actions, each with its own procedures.**

##### **A. Type I Action**

**A Type I action is a ministerial action reviewed by staff based on clear and objective standards. Clear and objective conditions may be placed on the decision, and notice of the decision is sent to the applicant and any interested party who requests a copy of the decision. Appeal is to the Planning Commission. The following actions are processed under the Type I procedure:**

- 1. Lot Line Adjustment**
- 2. Sign Permit**
- 3. Floodplain Permit**
- 4. Site Design Review**
- 5. Minor Partition**
- 6. Administrative Variance**
- 7. Willamette Greenway Administrative Review**

##### **B. Type II Action**

**A Type II action is a quasi-judicial review in which the Planning Commission applies a mix of objective and subjective standards that allow considerable discretion. Public notice is provided pursuant to Section 2.3. A public hearing is required for Type II actions unless otherwise specified. Appeal of a Type II decision is to the City Council. The following actions are processed under the Type II procedure:**

- 1. Variance**
- 2. Conditional Use Permit**
- 3. Major Partition**
- 4. Subdivision**
- 5. Planned Unit Development**
- 6. Similar Use Determination.**

### **C. Type III Action**

A Type III action is a quasi-judicial process in which the City Council applies a mix of objective and subjective standards, and makes the final, local decision. The Planning Commission plays an advisory role. Public notice is provided and, except as noted in subsection (4), public hearings are held before both the Planning Commission and City Council. Sections 2.3 and 2.4 list the notice and hearing requirements. Appeal of the decision is to the Land Use Board of Appeals (LUBA). The following actions are processed under a Type III procedure:

1. Zone Change
2. Comprehensive Plan Map Amendment
3. Annexation and Zone Change when requested concurrent with one another. The City Council reviews such a request without review or recommendation by the Planning Commission.
4. Site design review applications for commercial developments with more than 40,000 square feet of gross floor area.

### **D. Type IV Action**

A Type IV action is a legislative review in which the City considers and enacts or amends laws and policies. Private parties may request a Type IV action; however, it must be initiated by the Planning Commission, or City Council. The City Council makes the final, local decision. Sections 2.3 and 2.4 list the notice and hearing requirements.

1. Amendments and Revisions of the Comprehensive Plan
2. City Plan Document Adoption, e.g. Water System Plan
3. Zoning Code Amendments

### **11.015 (E): General Provisions.**

**12. Conditions of Approval:** Approvals of any quasi-judicial action may be granted subject to conditions. The following limitations shall be applicable to conditional approvals:

- a. Conditions shall be designed to protect public health, safety and general welfare. Conditions shall be related to the following:
  - i. Protection of the public from the potentially deleterious effects of the proposed use; or
  - ii. Fulfillment of the need for public service demands created by the proposed use.
- b. Changes or alterations of conditions shall be processed consistent with the level of review provided for the original approval.
- c. Whenever practical, all conditions of approval required by the City shall be completed prior to the issuance of an occupancy permit. When an applicant provides information that demonstrates to the satisfaction of the Planning Commission that it is not practical to fulfill all conditions prior to issuance of such permit, the Planning Commission may require a performance guarantee to ensure compliance with zoning regulations or fulfillment of required conditions.

## **SUBCHAPTER 60: PLANNED UNIT DEVELOPMENT**

### **60.060 (D)**

**8. The following plans and diagrams may be required if the Planning Commission finds that the PUD creates special problems of traffic, parking, landscaping, or economics:**

- a. An off-street parking and loading plan;**
- b. A circulation diagram indicating proposed movement of vehicles, goods, and pedestrians within the PUD and to and from the surrounding neighborhood, including any features and traffic regulation devices needed to facilitate traffic circulation;**
- c. A landscaping and tree plan;**
- d. An economic feasibility report or market analysis.**
- e. Special studies prepared by qualified professionals to determine potential traffic, geologic, noise, environmental, natural resource, or other impacts, and required mitigation.**

### **60.075 Action on Tentative Plan**

**The Planning Commission may approve, deny, or approve with modifications or conditions any tentative plan for a PUD or one or more phases of a PUD..**

## **SUBCHAPTER 90: SUBDIVISION REGULATIONS**

### **90.10.030 Conditions**

**The city may attach reasonable conditions to any approval it deems necessary to implement the provisions of this chapter and the Comprehensive Land Use Plan of the city; to ensure the general health, safety and welfare of residents of the city and to promote the economical and aesthetic development of land in the city.**

**90.60.030 Tentative Plat, Information. The following information shall be shown on the tentative plat:**

**Y. Traffic Impact Analysis. Depending on the nature and scope of the proposed development, the City Manager or designee may require a traffic impact analysis report, prepared by a registered transportation engineer, including the following:**

- 1. The total estimated vehicular, pedestrian, bicycle and other transit service trips to be generated from the proposed development;**
- 2. The impact of the total estimated vehicular, pedestrian, bicycle and other transit service trips on the existing street, sidewalk, bicycle and other transit systems within the City; and**
- 3. The estimated level of improvement necessary to mitigate the total impact from the proposed development as identified in item 2.**

These sections of the Independence Development Code address the requirements of TPR [660-12-045(2)(e)]. However, though these code sections provide clear authority for the City of Independence to assign conditions of approval, the City of Independence may want to consider adding code language which establishes clearer guidelines for when Traffic Impact Analysis is required. The decision to include such language should occur during the TSP development process.

### **Suggested Code Language**

Traffic Impact Analysis. The City Manager or designee may require a traffic impact analysis report, prepared by a registered transportation engineer, for any development permit or land use application. A traffic impact analysis report, prepared by a registered transportation engineer, shall be required for all development permits and land use applications which:

1. Generate an additional 200 vehicle trips per day; or
2. Affect a State transportation facility.

Traffic Impact Analysis Reports shall include:

1. The total estimated vehicular, pedestrian, bicycle and other transit service trips to be generated from the proposed development;
2. The impact of the total estimated vehicular, pedestrian, bicycle and other transit service trips on the existing street, sidewalk, bicycle and other transit systems within the City; and
3. The estimated level of improvement necessary to mitigate the total impact from the proposed development as identified in item 2.

### **Notification**

The TPR [660-12-045(2)(f)] requires notification be provided to transportation agencies of:

- Land use applications that require public hearings
- Subdivision and partition applications
- Other applications that affect private access to roads
- Other applications within airport noise corridors and imaginary surfaces that affect airport operations.

The Independence Development Code includes the following section on referral to other agencies for review:

#### **11.015 General Provisions**

**C. Citizen and Agency Involvement. The City shall provide opportunities for public and agency input in the planning process. The City shall give notice to: (1) the Oregon Department of Transportation (ODOT) regarding any proposed land use action within 250 feet of a State transportation facility and (2) the public works department of any jurisdictions (for example, Polk County), when any action by the City could potentially affect another jurisdiction's transportation facilities.**

Subchapters 77 & 78 include additional coordination with the Oregon Department of Aviation.

This language appears to meet the intent of TPR [660-12-045(2)(f)] for air transportation but is not adequate for ground transportation.

### **Suggested Code Language**

Add language to the existing Section 11.015 C of the Independence Development Code to ensure that ODOT and Polk County are notified of any:

- Land use applications that require public hearings
- Subdivision and partition applications
- Other applications that affect private access to roads

- Other applications within airport noise corridors and imaginary surfaces that affect airport operations.

## **Consistency with TSP**

The TPR [660-12-045(2)(g)] requires regulations assuring that amendments to land use designations, densities, and design standards are consistent with the functions, capacities and levels of service of facilities identified in the TSP. The purpose of this requirement is to ensure that a comprehensive plan amendment, zoning ordinance amendment or zone change considers the impact on traffic and is consistent with the TSP.

The Independence Development Code does not include consistency with the Transportation Plan as a standard for approving zone, comprehensive plan changes, variances, conditional uses, or PUD's. The Development Code does include consistency with the TSP as an approval criteria for major partitions and subdivisions:

**90.60.058 Preliminary Plat Approval Criteria. The Planning Commission may approve, approve with conditions or deny a preliminary plat based on the following approval criteria:**

- A. The proposed preliminary plat complies with the requirements for its submittal, all requirements of the Comprehensive Plan, all requirements of this Chapter, all requirements of the Zoning Code, and all other applicable laws and regulations.**
- B. All proposed streets, alleys, sidewalks, pedestrian facilities, bicycle facilities, pathways, utilities, and surface water management facilities conform or transition to the plats of subdivisions and major partitions already approved for adjoining property as to width, general direction, and all other respects and such facilities comply with the standards of the Monmouth Comprehensive Plan, Transportation System Plan, Zoning Code, and this chapter.**

### **Suggested Code Language**

No zone change, comprehensive plan change, variance, conditional use, or PUD shall be approved by the Planning Commission or enacted by the City Council unless it is consistent with the goals, policies, and implementation measures of the Independence Transportation System Plan.

## **Bicycle Parking**

The TPR [660-12-045(3)(a)] requires bicycle parking facilities as part of the multi-family residential units of four units or more, new retail, office or institutional developments, and all transit transfer stations and park and ride lots.

The Independence Development Code includes the following bicycle parking requirements which meet the intent of TPR [660-12-045(3)(a)]:

### **73.025 Parking of Bicycles**

- A. All parking lots for public, commercial, or industrial uses shall provide a minimum of one bicycle parking space for every 10 vehicle parking spaces.**
- B. Any apartment, dormitory, fraternity, sorority, student home, or other multiple-family residential structure having more than six four dwelling units or more than 12 residents shall provide a parking area for bicycles. The parking area shall be adequate to hold and permit the locking of one bicycle for every two dwelling units in the building or one bicycle for every four persons residing in the building, whichever requirement is less.**



## **Pedestrian and Bicycle Facilities**

The TPR [660-12-045(3)(b)] requires on-site facilities that accommodate safe and convenient pedestrian and bicycle access from within new subdivisions, multi-family developments, planned developments, shopping centers, and commercial districts to adjacent residential areas and transit stops, and to neighborhood activity centers within a half mile of the development. The TPR also provides that single-family residential developments shall generally include streets and access ways; and that pedestrian circulation through parking lots should generally be provided in the form of accessways.

The Independence Development Code provides the following guidance for on-site pedestrian and bicycle facilities for developments, including multi-family developments, planned developments, shopping centers, and commercial districts:

### **80.30 SITE DESIGN REVIEW APPLICATION REQUIREMENTS**

#### **80.30.005. Submission of documents.**

**C. Traffic, parking and circulation considerations. With respect to vehicular, bicycle, and pedestrian circulation, including walkways, interior drives and parking, special attention shall be given to the arrangement and relationships of buildings in terms of pedestrian accessibility, location and number of access points, general interior circulation, separation of pedestrian and vehicular traffic, and arrangement of parking areas that are safe and convenient and, insofar as practicable, do not detract from the design of proposed buildings and structures and the neighboring properties. Based on the anticipated vehicular, bicycle, and pedestrian traffic generated, consideration may need to be given to improvements to the right-of-way such as installation of lighting, signalization, turn lanes, paving, curbs, sidewalks, bikeways and other facilities required because of the increased traffic generated by the development.**

Because DC 80.30.005 does not apply to new subdivisions, full compliance with TPR [660-12-045(3)(b)] has not been attained.

#### **Suggested Code Language**

Incorporate the standards described in DC 80.30.005 into DC Subchapter 90: Subdivision Regulations.

## **Off-site Improvements**

The TPR [660-12-045(3)(c)] requires that off-site improvements that are required as a condition of approval include pedestrian and bicycle improvements, including bicycle ways along arterials and major collectors.

The Independence Transportation System Plan includes pedestrian and bicycle improvements and the Independence Development Code requires pedestrian and bicycle improvements, including bicycle lanes along arterials and major collectors:

### **Subchapter 90.90 DESIGN AND DEVELOPMENT STANDARDS**

#### **90.90.010 Streets.**

**A. General. The location, width, and grade of streets, bikeways and pedestrian facilities shall be considered in their relation to existing and planned streets, bikeways and pedestrian facilities, to topographical conditions, to public convenience and safety, and to the proposed use of the land to be served by the streets. All streets, bikeways and pedestrian facilities shall connect to other said facilities within the development and to existing and planned streets, bikeways, and pedestrian facilities outside the development. Where location is not shown in the**

Independence Transportation System Plan or other a development plan, the arrangement of streets in a subdivision shall either:

1. Provide for the continuation or appropriate projection of existing and planned streets, bikeways and pedestrian facilities in surrounding areas; or
2. Conform to a plan for the neighborhood approved or adopted by the Planning Commission to meet a particular situation where topographical or other conditions make continuance or conformance to existing streets, bikeways and pedestrian facilities impractical.

**D. Street Standards:**

Section	Type of Street	Right-of-Way Width	Paving Width	Sidewalk	Bicycle Facilities
A	Major Arterial	84 feet	60 feet	Yes	Bikelane
	Minor Arterial	66 feet	36 feet	Yes	Bikelane
B	Major Collector	66	36	Yes	Bikelane
	Minor Collector	66 feet	36 feet	Yes	Shared Roadway
C	Local residential streets serving more than 20 dwelling units	60 feet	36 feet	Yes	Shared roadway
D	Local streets and cul-de-sacs serving less than 20 dwelling units	50 feet	28 feet	Yes	Shared roadway
E	Circular end cul-de-sacs	112 feet	90 feet*	Yes	Shared roadway

This language appears to meet the intent of TPR [660-12-045(3)(C)].

**Internal Pedestrian Circulation**

The TPR [660-12-045(3)(e)] requires internal pedestrian circulation within new office parks and commercial developments to be provided through clustering of buildings, construction of accessways, walkways and similar techniques.

The Independence Development Code provides the following guidance for internal pedestrian circulation, which meets the intent of TPR [660-12-045(3)(e)]:

**80.30 SITE DESIGN REVIEW APPLICATION REQUIREMENTS**

**80.30.005. Submission of documents.**

**C. Traffic, parking and circulation considerations.** With respect to vehicular, bicycle, and pedestrian circulation, including walkways, interior drives and parking, special attention shall be given to the arrangement and relationships of buildings in terms of pedestrian accessibility, location and number of access points, general interior circulation, separation of pedestrian and vehicular traffic, and arrangement of parking areas that are safe and convenient and, insofar as practicable, do not detract from the design of proposed buildings and structures and the neighboring properties. Based on the anticipated vehicular, bicycle, and pedestrian traffic generated, consideration may need to be given to improvements to the right-of-way such as installation of lighting, signalization, turn lanes, paving, curbs, sidewalks, bikeways and other facilities required because of the increased traffic generated by the development.

## **Design Support for Transit Routes and Transit Access**

For urban areas where the area is already served by a public transit system, the TPR [660-12-045(4)] requires support of transit by requiring a variety of land use regulations. Given the population and location of the City of Independence, as well as the limited nature of transit currently serving the City of Independence, it was determined that only select sections of TPR [660-12-045(4)] should apply [(a), (b) & (e)]. These include the requirements that:

- Transit routes and facilities shall be supported through appropriate measures such as bus stops, pullouts, optimum road geometrics, or parking restrictions;
- New retail, office and institutional developments should include transit routes and facilities and convenient pedestrian access to transit through walkways and connections; and
- Allow existing developments to redevelop portions of parking areas for transit oriented uses where appropriate.

The existing Independence Comprehensive Plan, Development Code and TSP do not adequately address these requirements.

### **Suggested Code Language**

The updated TSP should include policy language calling for the development of the following land use requirements, when the population or available transit service warrants it:

- Transit routes and facilities shall be supported through appropriate measures such as bus stops, pullouts, optimum road geometrics, or parking restrictions; and
- New retail, office and institutional developments should include transit routes and facilities and convenient pedestrian access to transit through walkways and connections.

The following allowance should be incorporated into the Development Code:

- Allow existing developments to redevelop portions of parking areas for transit oriented uses where appropriate.

## **Pedestrian and Bicycle Plan for Developed Areas**

The TPR [660-045(6)] requires local governments to identify appropriate pedestrian and bicycle improvements in developed areas to provide for more direct, convenient and safer travel within and between residential areas and neighborhood activity centers (schools, parks, shopping areas).

The TSP includes pedestrian and bicycle improvements. As a part of the TSP update, the Ash Creek Trail Master Plan (April 2005) will be incorporated into the TSP. Additional pedestrian and bicycle improvements may also be identified during the TSP update.

## **Street Standards**

The TPR [660-12-045(7)] requires local governments to establish street standards that minimize pavement width and total right-of-way, consistent with the operational needs of the facility. The intent of this standard is to encourage local government to consider and reduce excessive standards in order to reduce construction costs, provide for more efficient use of urban land, provide emergency vehicle access while discouraging inappropriate traffic volumes and speeds, and accommodate convenient bicycle and pedestrian circulation.

The current street standards are found in the Independence Development Code:

Section	Type of Street	Right-of-Way Width	Paving Width	Sidewalk	Bicycle Facilities
A	Major Arterial	84 feet	60 feet	Yes	Bikelane
	Minor Arterial	66 feet	36 feet	Yes	Bikelane
B	Major Collector	66	36	Yes	Bikelane
	Minor Collector	66 feet	36 feet	Yes	Shared Roadway
C	Local residential streets serving more than 20 dwelling units	60 feet	36 feet	Yes	Shared roadway
D	Local streets and cul-de-sacs serving less than 20 dwelling units	50 feet	28 feet	Yes	Shared roadway
E	Circular end cul-de-sacs	112 feet	90 feet*	Yes	Shared roadway

### **Suggested Code Language**

Street standards, specifically standards for local streets, may be amended as a part of the TSP update to reflect the *Neighborhood Street Design Guidelines, An Oregon Guide to Reducing Street Widths*.

### **OHP Plan Policies**

The OHP states on p. 30 that “Local and regional jurisdictions must be consistent with...the State Highway Classification System, Land Use/Transportation, Highway Freight System, Scenic Byways, Major Improvements, Rail/Highway Compatibility, Freight movement, Transportation Demand Management and Investment Policies.” The Independence TSP, Comprehensive Plan and Development Code largely meet the requirements of this section. However, since adoption of the TSP in 1998, the Highway Segment Designations of the majority of OR 51 within Independence has been changed to Special Transportation Area, Commercial Center and Urban Business Area.

### **Suggested Code Language**

The TSP and Development Code should be updated to reflect the revised Highway Segment Designations on OR 51.

# City of Independence Transportation System Plan Technical Memorandum #3

*Prepared for*

**City of Independence**  
P.O. Box 7  
Independence, OR 97351

*Prepared by*

**Parametrix**  
700 NE Multnomah, Suite 1000  
Portland, OR 97232-4110  
503-233-2400  
[www.parametrix.com](http://www.parametrix.com)

## CITATION

This project is partially funded by a grant from the Transportation and Growth Management (TGM) Program, a joint program of the Oregon Department of Transportation and the Oregon Department of Land Conservation and Development. This TGM grant is financed, in part, by federal Safe, Accountable, Flexible, Efficient Transportation Equity Act: A Legacy for Users (SAFETEA-LU), local government, and State of Oregon funds.

The contents of this document do not necessarily reflect views or policies of the State of Oregon.

Parametrix. 2007. City of Independence Transportation System Plan  
Technical Memorandum #3. Prepared by Parametrix, Portland, Oregon. May 2007.

## TABLE OF CONTENTS

<b>1. PURPOSE</b> .....	<b>1-1</b>
<b>2. BACKGROUND AND CONTEXT</b> .....	<b>2-1</b>
2.1 EXISTING RAIL FREIGHT SERVICE IN INDEPENDENCE.....	2-1
2.2 PREDICTED FUTURE RAIL SERVICE IN INDEPENDENCE.....	2-1
<b>3. RAIL OPERATIONS ISSUES</b> .....	<b>3-1</b>
<b>4. OPTIONS AND RECOMMENDATIONS</b> .....	<b>4-1</b>
4.1 STREET AND RAIL RECONSTRUCTION .....	4-1
4.2 IMPROVED CROSS-SECTION.....	4-2
Existing Conditions .....	4-2

## LIST OF FIGURES

Figure 1. Independence Street System

Figure 2. Alternative Design Options

## APPENDICES

APPENDIX A.....	Photographs
APPENDIX B.....	Construction Cost Estimates

**This page intentionally left blank.**



# 1. PURPOSE

The Portland & Western (P&W) Railroad alignment within the City of Independence includes four city blocks in the heart of downtown. These tracks run along 2nd Street, from B Street to E Street, and except for one roadway crossing, consists of rail ties covered in the asphalt roadway surface. A variety of conflicts exist between P&W's operations on this four block segment and those living, doing business, and traveling through the community. These conflicts include:

- Traffic interruptions on the City of Independence's primary travel corridor (Oregon 51 – Main Street and Monmouth Street);
- Reduced rail operating speeds;
- Potential delays in emergency service response to eastside residents and businesses;
- Unsafe conditions for pedestrians and bicyclists traveling adjacent to and / or crossing the 2nd Street tracks;
- Potentially unsafe conditions for vehicular traffic crossing 2nd Street at B, C, D and E Streets and for vehicular traffic crossing railroad tracks while entering and exiting driveways along 2nd Street;
- Unsafe sharing of the 2nd Street travel lanes by vehicular traffic, bicyclists and trains; and
- Increased roadway and railway maintenance issues along 2nd Street.

Though the conflicts between railroad operations and other road users aren't solely the result of the downtown 2nd Street trackage, this track segment contributes disproportionately to the problems experienced.

The Oregon Rail Freight and Passenger Plan (2001) calls for the integration of rail freight considerations into the state's land use planning process, seeking to specifically "minimize conflicts between railroad operations and other urban activities." This memo details the current and assumed future problems associated with 2nd Street railroad operations, from B to E Street, as well as makes recommendations for how to mitigate these problems. This memo is being prepared in conjunction with the City of Independence Transportation System Plan (TSP) update. As TSPs are a part of the state land use planning process, the Oregon Rail Freight Passenger Plan (2001) applies to the Independence TSP update, and the issues and recommendations identified in this memo will be incorporated into the TSP.

**This page intentionally left blank.**

## **2. BACKGROUND AND CONTEXT**

This chapter identifies the existing and expected future rail operations within the City of Independence. Information in this chapter comes from the Independence TSP (1998), with updates provided from 2007 phone conversations and email exchanges with Bob Melbo and Glen Kirkpatrick of ODOT's Rail Division. Phone calls to the P&W Railroad to verify and supplement the information in this chapter were not returned.

### **2.1 EXISTING RAIL FREIGHT SERVICE IN INDEPENDENCE**

Rail transportation service is currently provided in the City of Independence by the P&W Railroad, which generally runs north-south through the community in the middle of the 2nd Street alignment (see Figure 1). P&W's goal is to maintain its Independence trackage, at a minimum, to Federal Railroad Administration Class 2 standards, which permits freight train operation at 25 mph.

According to ODOT, in 1998, the line through Independence handled about 1 million gross ton miles yearly (a gross ton mile is one ton hauled one mile), a measurement that includes the weight of cars, contents, and locomotives. Since late 2002, when P&W leased the parallel Oregon Electric line on the east side of the Willamette River, traffic through Independence has declined somewhat from the 1998 level. During 2006 and entering into 2007, P&W has consistently operated one southbound and one northbound train daily, seven days each week along the line through Independence. The railroad operations are dictated by the needs of customers and actual schedules vary from week-to-week. According to ODOT, the average size of these trains is around 50 cars and three locomotives, or about 4,000 feet in length.

Simplot, the only P&W shipper located in Independence, ships fertilizer and herbicides. The line also provides freight service for a large variety of commodities including forest products, iron and steel products, feed grains, and some manufactured consumables, including food products. In addition to Simplot, shippers on the track are Cascade Steel Mills in McMinnville, Weyerhaeuser Company in Dallas, Hampden Lumber in Willamina, SP Newsprint in Newberg, and Cascade Structural Laminating in Fort Hill.

### **2.2 PREDICTED FUTURE RAIL SERVICE IN INDEPENDENCE**

Rail freight traffic through Independence is predicted to increase marginally during the next 20 years. While P&W expects to see significant overall growth in traffic on its system, the Oregon Electric line across the river from Independence has displaced the western Willamette Valley line via Independence as the core north-south route. For the next 10 years, ODOT-Rail expects the west side Independence line to be the preferred conduit for rail transportation into and out of Polk and Yamhill Counties, even though a northern route exists between Newberg and the Portland area via Rex Hill. Rex Hill, however, is beset with heavy grades and curvature and various degrees of deferred track and bridge maintenance. P&W keeps the line serviceable as a detour for the Oregon Electric line; otherwise Rex Hill does not see regular daily use. Consequently, rail traffic through Independence is expected to mirror current volumes of one daily through train each direction seven days a week, augmented with switch engine visits from either Corvallis or McMinnville as dictated by needs of local businesses receiving freight by rail.

Longer term, 2026 and later, regional expansion of Portland-area commuter rail service can be expected to reach McMinnville via Rex Hill, and possibly be extended to Independence and Corvallis. If commuter rail service reaches Independence, the west side rail line through

Independence will be upgraded from a slow-speed freight-only railroad into a relatively high-speed, well-maintained passenger line. In its improved state, the line will continue to carry freight indigenous to Polk and Yamhill Counties. Some additional through freight is likely to use the route as well, as public capital invested for passenger improvements will mitigate barriers that discourage through freight movements today.

Presently, it is expected that vacant industrial lands in Independence will be used by smaller businesses that typically do not ship by rail. As such, Independence does not envision much new local business and industrial use of the railroad during the next twenty years. However, the community recognizes the importance of rail to the regional economy and the potential public transportation uses, and other unforeseen uses that may develop during the next 40 years. Therefore, the community believes that current and future needs center around conflict minimization that protects the future functionality of the railroad and reduces ongoing conflicts.

### 3. RAIL OPERATIONS ISSUES

The Independence P&W rail route runs parallel to one arterial (Oregon 51 – Main Street) and crosses two other arterials (Oregon 51 – Monmouth Street and Polk Street) and a collector street (Stryker Road). The configuration of the railroad, and arterial and collector streets results in temporary interruptions on the major east-west routes when trains pass through Independence. Interruptions in east-west traffic on Oregon 51 – Monmouth Street also leads to interruptions to north-south traffic on Oregon 51 – Main Street. Due to the condition of the 2nd Street track (see text below), from B Street to E Street, rail operations are currently limited to 10 mph along this portion of the line. According to ODOT's Rail Division, the optimal train speed through Independence would be 25 mph. The slow speed of trains in Independence results in unnecessarily long delays to vehicular (as well as pedestrian, bicyclist, and transit) traffic as well as longer trip times for the P&W Railroad.

Street interruptions also lead to compromised emergency response capabilities. The fire and rescue and police stations are located west of the track, which gives them access to most of the city. However, train delays cause detours for emergency vehicles trying to reach the eastern edge of town, including the downtown, waterfront park, and other eastside residences and businesses.

Historically, there have been conflicts between the community of Independence and the railroad operators regarding pavement maintenance on 2nd Street. Parametrix performed field observations of this street segment in May of 2007. Observations are divided into two portions of 2nd Street's curb-to-curb width:

- **Parking and Driving Lane:** The asphalt pavement surface of the parking lane and the majority of the driving travel lane are in good condition, with only minor cracking and some areas of previous utility work that have received patch repairs. The pavement surface does not appear to be rutted by vehicular travel.
- **Center Rail Tracks and Adjacent Pavement:** The center rail tracks share the north and southbound driving lanes (the asphalt street surface covers the space adjacent to, and between, this segment of rail trackage, including four of the five at-grade road crossings). The asphalt pavement immediately adjacent to, and between, the rail tracks is in poor condition (see Appendix A), with extensive cracking of the pavement surface and including sections of exposed aggregate. Some sections of trackage are experiencing permanent settlement, resulting in an irregular pavement surface. It is assumed that the settlement is the result of heavy rail loads flexing the pavement, and indicates that the existing pavement structure is insufficient to handle the rail operations it has been experiencing. The rail trackage at the at-grade crossing of 2nd Street and Monmouth Street – Oregon 51 has the additional support of concrete panels, adjacent to, and between, the rail tracks. The concrete panels and this section of trackage appears to be in good condition. The asphalt road surface adjacent to the concrete panels was either repaired after, or rebuilt when, the concrete panels were installed, and also appears to be in good condition.

The failing rail sections and adjacent asphalt has resulted in unsafe conditions, such as tripping hazards for pedestrians and roadway obstacles for pedestrians, wheelchair users and bicyclists. The failing rail sections also result in potentially unsafe conditions for vehicular traffic crossing 2nd Street at B, C, D and E Streets, and for vehicular traffic crossing railroad tracks while entering and exiting driveways along 2nd Street. Because trains essentially share a portion of the 14' southbound and 14' northbound travel lane, train operators, railroad maintenance personnel, drivers, and bicyclists are at increased risk of collision.

Although railroad activity should remain relatively flat or increase slightly during the next 20 years, increases in vehicular traffic could result in more railroad-related conflicts related to the 2nd Street, from B Street to E Street, trackage. Unresolved, the increases in railroad-related conflicts could further impair the function of the railroad and other elements of the transportation system. As the existing pavement structure and rail bed are not designed to accommodate the rail and vehicular traffic that is using them, increased vehicular traffic and expected rail usage will increase the need for ongoing maintenance and speed up the timetable for rebuilding the facility.

## 4. OPTIONS AND RECOMMENDATIONS

This chapter identifies the options and recommendations for resolving existing, and avoiding potential future, conflicts between the railroad and other users of the downtown 2nd Street segment. The recommendation is to resolve conflicts by taking two actions:

1. Reconstruct 2nd Street by structurally separating the driving road surface and subsurface from the rail tracks, ties and subsurface and constructing a new system of rail tracks, ties and subsurface that can accommodate the weight of the trains.
2. Provide greater physical distance between the train operations and other roadway users by implementing a new street cross-section.

There are multiple options for implementing the actions described above, each resulting in different trade-offs between project cost, rail and road safety, and downtown livability. Several of these options are described below. It is important to note that the options identified are a starting point, and other options for implementing the recommendations exist. Three entities share responsibility and authority over implementing these recommended actions, and which option is chosen will be subject to negotiation between these entities:

- The City of Independence owns, manages and maintains 2nd Street, except for where 2nd Street crosses Monmouth Street – Oregon 51 and for the rail right-of-way and road crossings.
- The ODOT Rail Division has standards for rail signage, crossings, safety features, and other aspects of rail related design. ODOT's Highway Division is also the owner of the 2nd Street / Monmouth Street – Oregon 51 intersection.
- The P&W Railroad owns, manages and maintains the right-of-way under and adjacent to their trackage.

### 4.1 STREET AND RAIL RECONSTRUCTION

The existing design of 2nd Street, where the roadway and rail infrastructure is a part of the same asphalt street, fails to meet the City of Independence and P&W Railroad's operational, maintenance and safety needs. A rail design treatment is needed that will allow trains to travel up to the optimal speed of 25 mph without experiencing rapid infrastructure deterioration, thereby ameliorating many of the conflicts identified in chapter 1.

The most common of the two design treatments is an open ballast system, separated from the asphalt parking and driving lanes. The second design treatment entails using concrete panels adjacent to, and between, the rail tracks, along the entire 2nd Street segment (the concrete panels would be of the same construction as the panels currently used at the 2nd Street and Monmouth Street – Oregon 51 crossing). Deciding which railway design treatment to pursue involves trade-offs between a number of issues, including ongoing railway maintenance, aesthetics and construction cost.

The open ballast design treatment is the easiest and least expensive design treatment to maintain. Railway operators are responsible for, among other things, inspecting the tie and rail conditions and fastenings and crossing warning system circuitry. When track is covered by concrete panels, the railway's ability to inspect their facilities is made more difficult. When maintenance is required, ballast can be removed and replaced relatively easily compared with bringing special equipment to lift and replace concrete panels.

Aesthetically speaking, open ballast systems are less attractive than concrete panels. This can be viewed as especially important in historic downtowns, such as the Independence

downtown. In addition to aesthetic concerns of the facilities themselves, open ballast systems pose challenges to existing systems of eliminating street litter. Conventional street cleaning equipment cannot pick up litter that gets stuck in ballast.

Construction cost is also a consideration in railway design treatments. The West Rail Construction Company has submitted a \$3,043,243 bid to P&W for rebuilding 2nd Street, B Street to E Street (see Appendix B). The bid is for both trackage and roadway improvements, and includes new signals and gate arms at each road crossing (B, C, Monmouth Street, D, and E), storm drain catch basins, and curbing on each side of track. This bid assumes open ballast trackage between road crossings, with concrete panels at each road crossing.

We have prepared a planning level cost estimate for a project covering all the same project components as the West Rail Construction Company bid, but with replacing open ballast with concrete panels the entire length of the 2nd Street segment. This cost estimate was generated using West Rail Construction Company's unit prices from their bid, adjusting the total bid by assuming 1410 feet (the length of 2nd Street, from B to E Streets) of concrete panels and track (line items 10 & 11) and eliminating the open ballast and track costs (line item 9). It is important to note that this method of cost-estimating produces only a planning level estimate and will include some imprecision. These calculations indicated that a total concrete panel rail system adds an additional \$435,306, or an approximately additional 14 percent, of project costs, raising the total project costs to \$3,478,549.

Lastly, an open ballast system prevents the possibility of allowing mid-block track crossings, as can occur when vehicles and bicyclists enter and exit driveways. While curbing can be added to an entirely concrete panel system, to similarly prevent mid-block crossings, concrete panel systems have the option of also allowing mid-block crossings. While eliminating mid-block crossings improves safety, preventing mid-block crossings reduces the convenience of access to 2nd Street's government services (library, city hall, post office, and police station) and businesses.

## 4.2 IMPROVED CROSS-SECTION

Figure 2 presents the existing and three potential cross-sections for this 2nd Street segment. Each alternative increases the distance between vehicular / bicycle traffic and rail tracks, a significant safety improvement. Each alternative also maintains the existing track location – the center of the street. Maintaining the existing track location was chosen because it:

- Minimizes conflicts with existing drive-way accesses on 2nd Street;
- Maximizes livability by keeping the train furthest from sidewalks and buildings; and
- Makes it less expensive for 2nd Street tracks to connect with the remaining rail trackage to the north of B Street and to the South of E Street.

Additional features of each cross-section, and resulting trade-offs, are discussed below.

### Existing Conditions

2nd Street between B Street and E Street has 68' of right-of-way, which includes 5' wide sidewalks and a 6' planting strip on both its east and west sides. This section of 2nd Street is approximately 44' in width, curb-to-curb. The current street cross-section for 2nd Street (see Figure 1) includes 8' parking on both sides of the street, two travel lanes (one north, one south) and train tracks running down the center of the roadway. This section of street is classified as a Local Service Street, which calls for shared bicyclist and vehicle use of the driving lane. There is no striping separating the driving lanes from the rail tracks, so the railroad, vehicles and bicyclists share the middle 28' feet of roadway surface, creating a very



narrow driving lane when a train is present and posing the risk of collisions between roadway users.

The land uses along 2nd Street, from B Street to E Street, include public uses (city hall, post office and library), retail businesses and detached single family homes. Many of these uses have driveways onto 2nd Street.

B, C, Monmouth, D, and E Streets all intersect with 2nd Street. Additional information on each crossing street is as follows:

- Though the rail tracks continue, 2nd Street stops at B Street, forming a “T” intersection. B Street is a Local Service Street.
- C Street is a Local Service Street, and is a one-way (west) facility to the east of 2nd Street, and is a two-way street to the west of 2nd Street.
- Monmouth Street is a District Level State Highway (Oregon 51).
- D Street is a Local Service Street.
- Though the rail tracks continue, 2nd Street stops at E Street, forming a “T” intersection. E Street is a Local Service Street.

### **Alternative 1**

Alternative 1 maintains the existing sidewalks, planting strips, and curbs as found in the Existing Condition. However, the parking lanes are removed, and their 16’ of usable street space is reallocated to driving and rail uses. Alternative 1 provides a 13’ 6” dedicated north and southbound travel lane that is separated with curbing from 17’ of space dedicated to rail use. It is important to note that the curb would not be located at street crossings.

The 17’ train envelope was chosen based on related standards from the ODOT Rail Division. While the Rail Division has no standard clearance between tracks and vehicular travel lanes, the Rail Division does require that no structure be located closer than 8’ 6” from track centerline. It is reasonable to apply at least that standard for vehicles, vehicles which hypothetically could park near the tracks and open their doors into the train envelope.

Alternative 1 increases the safety of all road and rail users by preventing mid-block crossings and by controlling the minimum distance between moving trains and other road users. Alternative 1 is also the least cost alternative, as it maintains the existing sidewalks, planting strip and roadway curbs.

Alternative 1 has positive and negative impacts on downtown livability. Positive impacts include the preservation of the two planting strips, while negative impacts include the elimination of on-street parking and mid-block crossings.

The proposed TSP calls for diverting southbound (Main Street) to westbound (Monmouth Street) Oregon 51 traffic to C Street, and then potentially diverting this traffic back to Monmouth Street via 2nd Street. By eliminating on-street parking in the southbound lane, and providing a dedicated 13’ 6” southbound driving lane, Alternative 1 could easily accommodate this diverter project.

### **Alternative 2**

Alternative 2 maintains the sidewalks, planting strips, and curbs on the west side of the street, as found in the Existing Condition. Alternative 2 removes the west side parking lane, and provides a 13’ 6” southbound driving lane. As with Alternative 1, Alternative 2 provides 17’ of space dedicated to rail use, separated from the driving lanes with curbing.

Alternative 2 adds 6" to the sidewalk on the east side of 2nd Street, bringing the total sidewalk width to 5' 6". Alternative 2 eliminates the east side parking strip so as to maintain a parking lane, and leaves 11' for a driving lane, a reasonable width for a Local Service street.

Alternative 2 increases the safety of all road and rail users by preventing mid-block crossings and by controlling the minimum distance between moving trains and other road users. Alternative 2 is more expensive than Alternative 1, as it removes one of the existing curbs, requiring some reconstruction of the east side of the street.

Alternative 2 has positive and negative impacts on downtown livability. Positive impacts include the preservation of one of the planting strips and one parking lane, while negative impacts include the elimination of a planting strip and a parking lane, as well as elimination of mid-block crossings.

As with Alternative 1, Alternative 2's 13' 6" southbound driving lane and lack of parking could easily accommodate this diverter project.

### **Alternative 3**

Alternative 3 increases the sidewalk widths by one foot and eliminates the existing planting strips and curbs. Alternative 3 provides new 8' parking lanes, and has no curbs to separate the train use from the driving lanes, creating a north and southbound 19' shared driving and train use lanes.

Alternative 3 increases the safety of all road and rail users by providing an additional 5' of shared use lane in each direction compared with the Existing Condition. However, Alternative 3 is not as safe as Alternative 1 or 2, as it does not include curbing to prevent mid-block crossings nor to ensure a minimum distance between moving trains and other road users. Alternative 3 is more expensive than Alternative 1, as it removes one of the existing curbs, requiring some reconstruction of the east side of the street.

Alternative 3 has positive and negative impacts on downtown livability. Positive impacts include the preservation of parking lanes and mid-block crossings, while negative impacts consist of the elimination of planting strips.







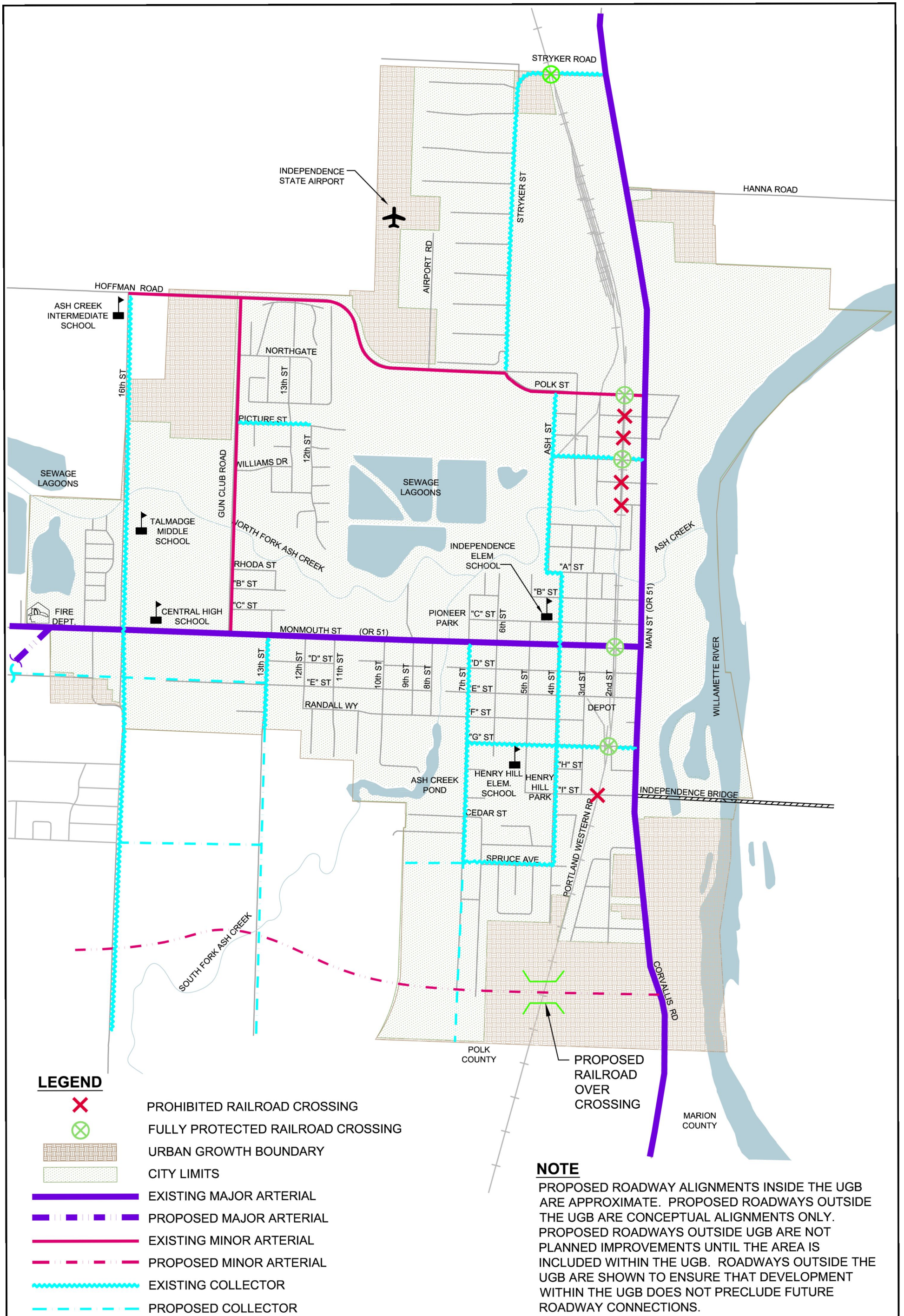



The increased width of the shared southbound driving and rail use lane allows Alternative 3 to more easily accommodate the diverter project than the Existing Condition. However, Alternative 3 retains parking on the southbound lane and does not have curbing to prevent mid-block crossings or to ensure a minimum distance between moving trains and other road users, and therefore Alternative 3 is less accommodating to the diverter project than Alternative 1 or 2.

## FIGURES





**LEGEND**

-  PROHIBITED RAILROAD CROSSING
-  FULLY PROTECTED RAILROAD CROSSING
-  URBAN GROWTH BOUNDARY
-  CITY LIMITS
-  EXISTING MAJOR ARTERIAL
-  PROPOSED MAJOR ARTERIAL
-  EXISTING MINOR ARTERIAL
-  PROPOSED MINOR ARTERIAL
-  EXISTING COLLECTOR
-  PROPOSED COLLECTOR

**NOTE**

PROPOSED ROADWAY ALIGNMENTS INSIDE THE UGB ARE APPROXIMATE. PROPOSED ROADWAYS OUTSIDE THE UGB ARE CONCEPTUAL ALIGNMENTS ONLY. PROPOSED ROADWAYS OUTSIDE UGB ARE NOT PLANNED IMPROVEMENTS UNTIL THE AREA IS INCLUDED WITHIN THE UGB. ROADWAYS OUTSIDE THE UGB ARE SHOWN TO ENSURE THAT DEVELOPMENT WITHIN THE UGB DOES NOT PRECLUDE FUTURE ROADWAY CONNECTIONS.



**Figure 1**  
**Independence Street System**

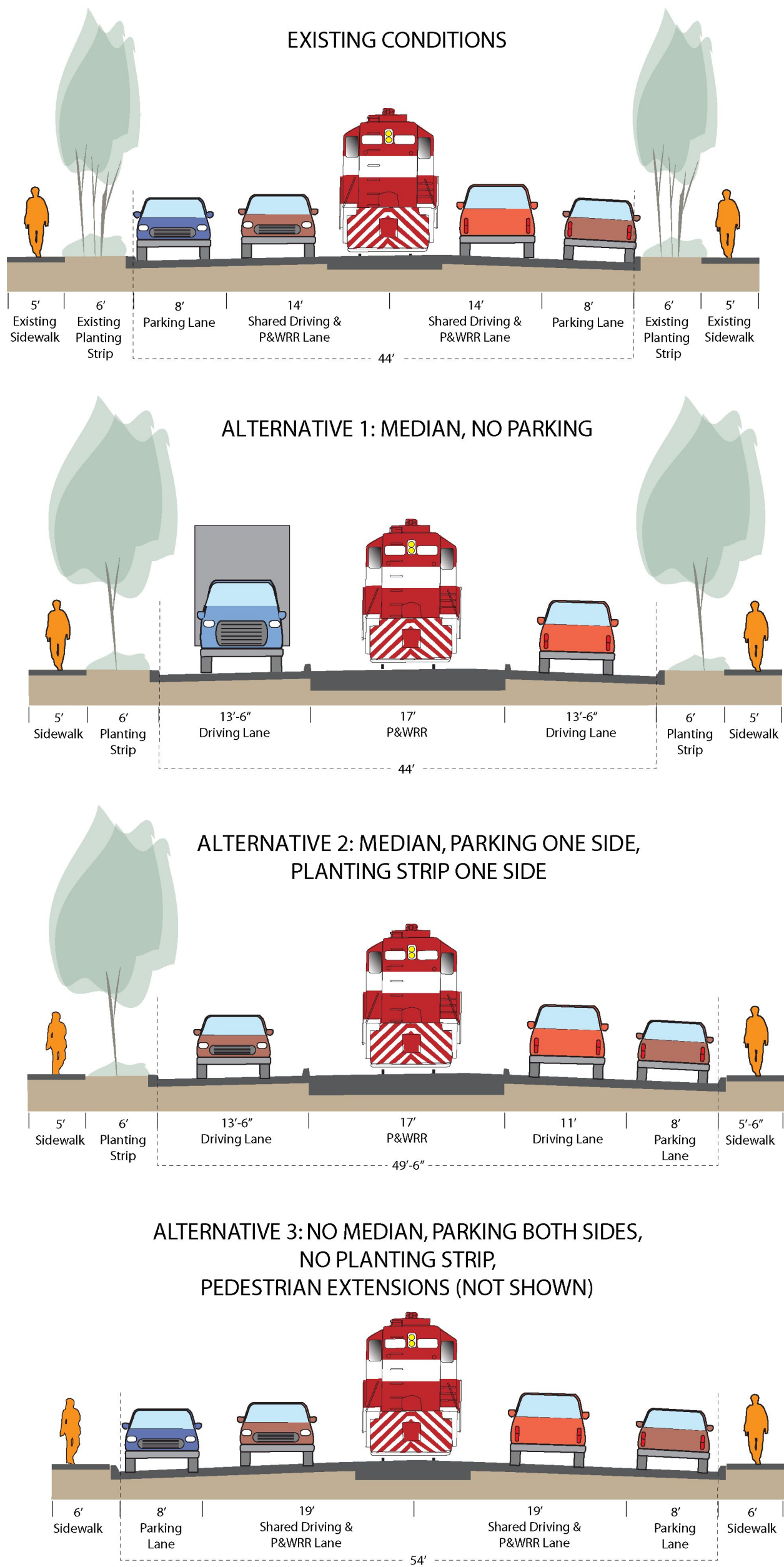

FIGURE 2

## **APPENDIX A**

### **Photographs**





## **Parametrix**



**2nd & C, Looking North with Train**



**2nd & C, Looking North**

**Parametrix**



**2nd & Monmouth, Looking North**



**2nd & Monmouth, Looking South**

## **Parametrix**



**2nd & Monmouth, Looking Southeast**

## **Parametrix**

**This page intentionally left blank.**

**APPENDIX B**  
**Construction Cost Estimates**





West Rail Construction Company  
P.O. Box 820626  
Vancouver, WA 98682

Phone (360) 260-0668  
Fax (360) 260-0670  
E Mail [wrcvern@comcast.net](mailto:wrcvern@comcast.net)

Feb. 26, 07

Independence

City of Independence  
240 Monmouth Street  
Independence, OR 97351

Attn: Michael Danko  
RE: 2<sup>nd</sup> Avenue Railroad

Mr. Danko;

Enclosed with this letter are copies of a conceptual budgetary proposal I submitted to the Portland and Western RR, following our meeting with you last October. I discussed sending this to you at the first of February.... Note this was sent to the Railroad last December.

The proposal includes both track and street elements. It includes railroad signal work. It is my understanding that these are elements which will assist in search for funding.

Please do not hesitate to call if you have any questions or comments. West Rail is confident in our ability to provide safe and efficient service meeting all your expectations.

Sincerely;

Vernon Boley  
West Rail Construction Company  
[www.westrailconstruction.com](http://www.westrailconstruction.com)

*Bonded and Licensed*

Washington WESTRCC995PD  
Oregon 112222



West Rail Construction Company  
P.O. Box 820626  
Vancouver, WA 98682

Phone (360) 260-0668  
Fax (360) 260-0670  
E Mail [wrcvern@comcast.net](mailto:wrcvern@comcast.net)

Dec. 5, 06

Inde.Budget

Portland and Western Railroad  
650 Hawthorne Avenue  
Suite 220  
Salem OR 97301

Attn: Dale Hansen

RE: Independence 2<sup>nd</sup> Avenue

Dale;

Following up on the meeting, in Independence City Hall, a couple weeks ago. West Rail offers this budget and concept for improving both track and street. You will find following a unit price schedule for your evaluation. West Rail would be proud to perform this project.

Slightly more than 1400 feet of street and track will be removed and replaced. The roadbed shall be excavated 18-feet wide by 2-feet deep (Refer to the attached sketch crosssection). The reconstruction will include concrete curbing each side of the track, delineating the street from the railroad. When complete the top of rail will be about 8-inches higher than that existing now.

The five cross street intersections - will be raised to match the new top of rail. Omega Industries prefabricated concrete panels shall be installed at these crossings, assumed to be 60-feet in length. New storm drain catch basins will be installed and the street surface sloped to match the existing grade over about 30 feet each direction. Pavement markings, including raised pavement dots, will be installed to deter traffic from entering the railway corridor at each block. Each intersection will have a railroad signal system installed, including gate arms, which shall be an integrated multiple approach system.

Track construction is estimated to be with new industrial 136RE rails on concrete ties. The intersecting street crossings shall be 136RE on ten-foot hardwood ties. All rails will be welded throughout. Ballast rock shall be a minimum of 12-inch depth below bottom of the crossties. Subballast depth shall be 12-inches with 16 ounce filter fabric. Perforated underdrains shall be installed each side of the track. It is currently thought that, by raising the track that these pipes can connect to the City's storm drain system.

The construction will be phased by leaping block by block. Contract length is anticipated to be 180 work days with about 24 weeks of on site construction. This budget does not include Prevailing Wage. Each intersection will be closed about 2 weeks, with very limited public access block by block.

The budget contains approximately \$200,000 in funds for PWRR administration and railroad flagging. We include costs for survey and engineering.  
Budget excludes any over excavation.  
Budget excludes Railroad Insurance

Bonded and Licensed  
Washington WESTRCC995PD  
01/01/00-1/01/00





**West Rail Construction Company**

Independence 2nd Avenue

12/5/2006



Description	Quantity		unit price	BID AMOUNTS
1 Mobilization	1	ls	\$25,932.00	\$25,932.00
2 Engineering+ Surveying for perf pipe, curbs, subballast, and tr	1	ls	\$190,227.00	\$190,227.00
3 Asphalt Sawcutting	3520	lf	\$5.00	\$17,600.00
4 Removal Asphalt 2nd Ave + intersections, w/ haul / disposal	43500	sf	\$5.00	\$217,500.00
5 Removal of Track	1410	tf	\$15.00	\$21,150.00
6 Excavate w/ Haul / Dispose Roadbed	3400	cy	\$21.00	\$71,400.00
7 Subballast and 16 oz Geotextile	1525	tn	\$36.00	\$54,900.00
8 Concrete Curbing 24" h x 10" b, slip formed	260	cy	\$732.00	\$190,320.00
9 Construct Open Track welded 136RE and Concrete Tie	860	tf	\$197.00	\$169,420.00
10 Construct Railroad Crossings Intersections, Track Only	550	tf	\$266.00	\$146,300.00
11 Install Concrete Panels	366	tf	\$360.00	\$131,634.00
12 Thermiter Prep Welds	46	ea	\$806.00	\$37,076.00
13 Thermiter in Track Welds	20	ea	\$1,398.00	\$27,960.00
14 Destressing	1440	tf	\$9.00	\$12,960.00
15 Traffic Control	5	blocks	\$7,610.00	\$38,050.00
16 RR Signal modification Monmouth Street	1	lot	\$193,271.00	\$193,271.00
17 New RR Signal B,C,D,E Streets	4	ea	\$311,972.00	\$1,247,888.00
18 Asphalt Patching 2nd Avenue with base rock prep.	175	tn	\$317.00	\$55,475.00
19 Intersection Mods: B,C,D,E Streets: Asp + Base + pvmt mark	250	tn	\$310.00	\$77,500.00
20 Perforated Pipe and connections	3320	lf	\$11.00	\$36,520.00
21 Catch Basins	40	ea	\$2,004.00	\$80,160.00
				\$3,043,243.00

West Rail trusts this information is of use for the Railroad's and the City's budgeting purposes. Please add escalation to the above estimate.

West Rail believes this project to be an excellent fit for our company; it includes elements of track, excavation and utility work, all work we perform. West Rail is confident in our ability to provide safe and efficient service meeting all your expectations. Please do not hesitate to call if you have any questions or comments.

Sincerely;

Vernon Boley

Bonded and Licensed  
WEST00000000

USSS Independence, Oregon, United States 30 Jul 2000

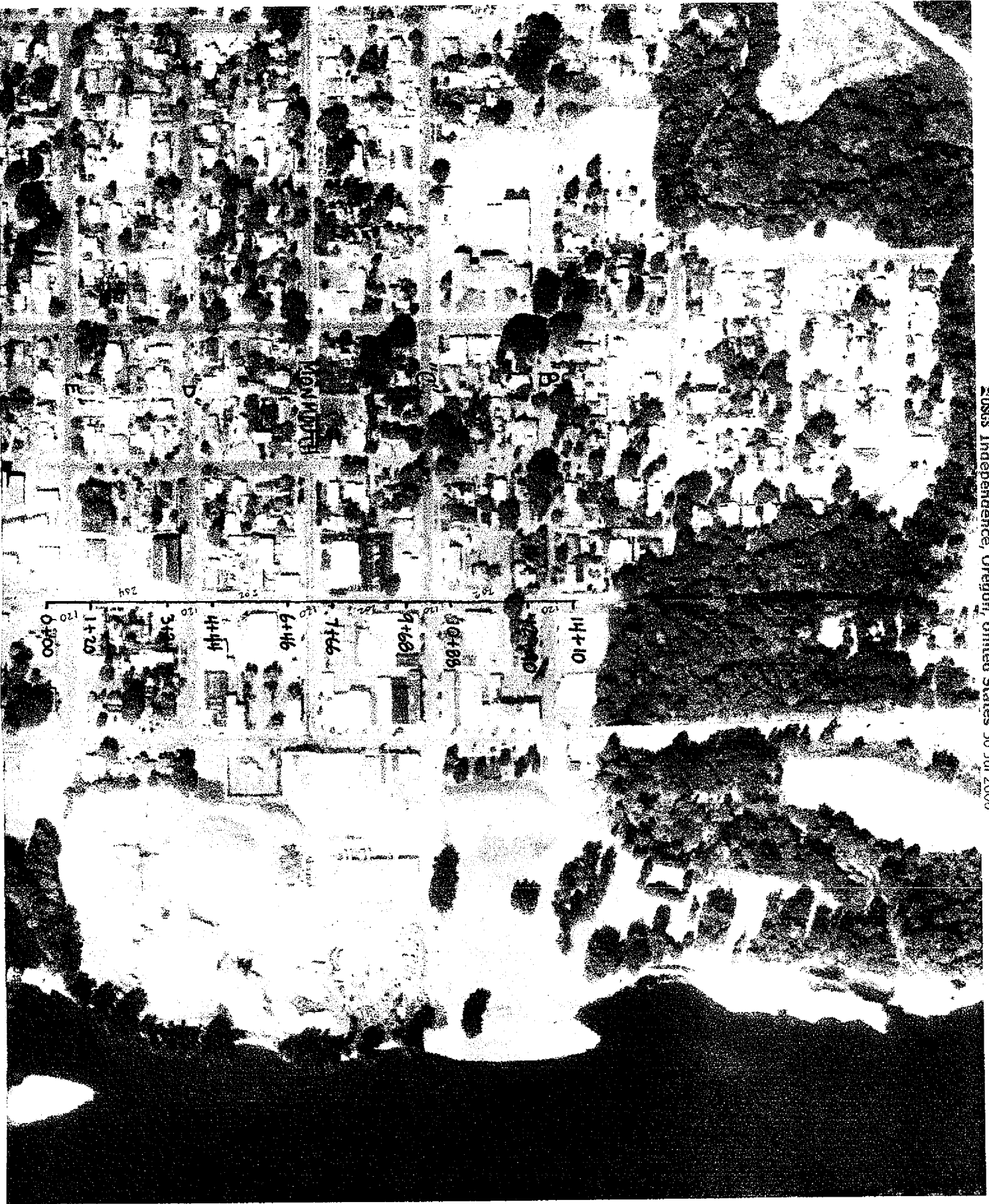

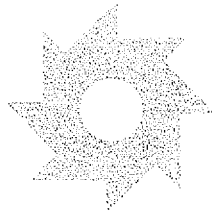

# SUNBELT RENTALS

www.sunbeltrentals.com

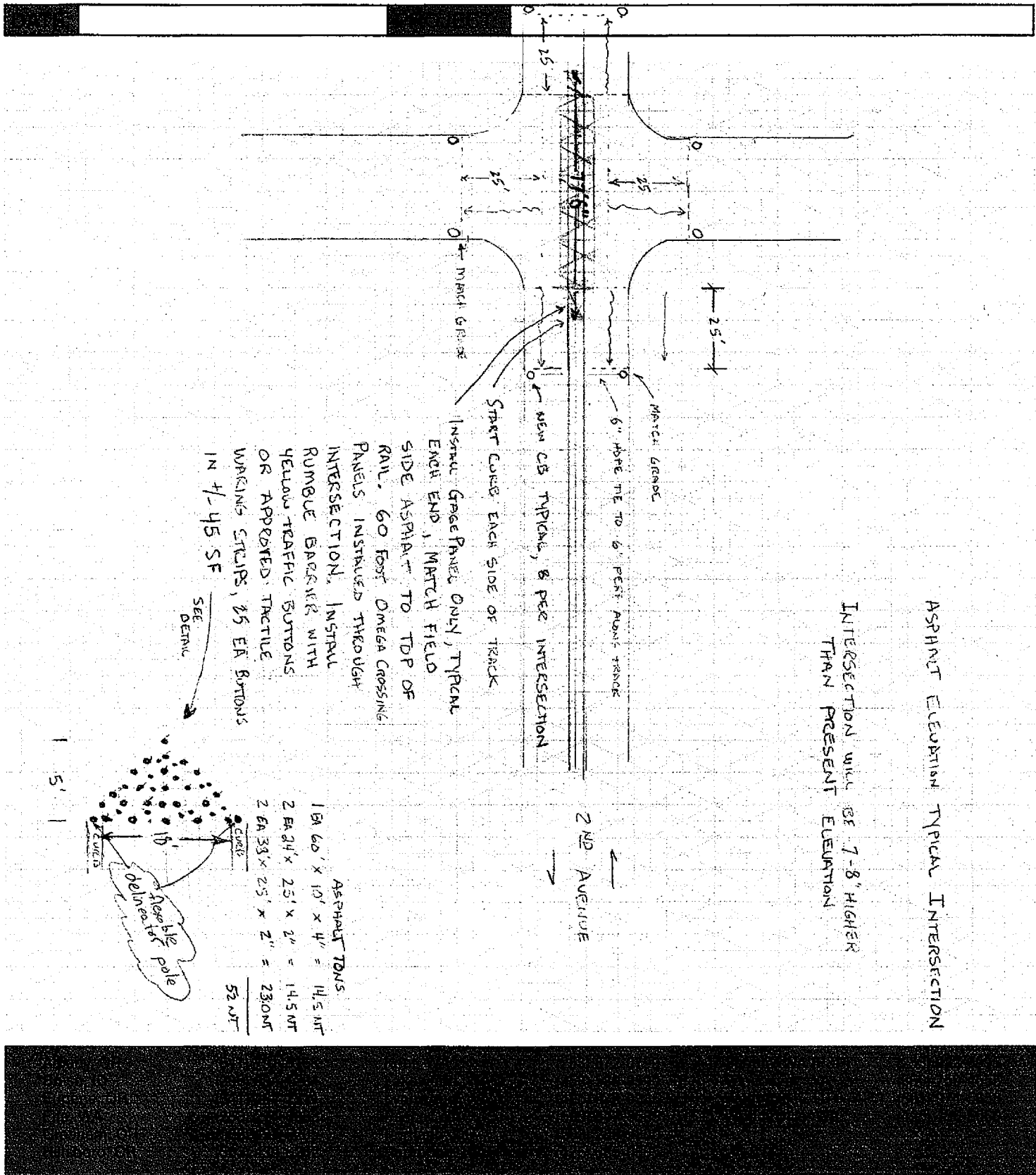

INSTALL GRADE PANEL ONLY, TYPICAL EACH END, MATCH FIELD SIDE ASPHALT TO TOP OF RAIL. 60 FOOT OMEGA CROSSING PANELS INSTALLED THROUGH INTERSECTION. INSTALL RUMBLE BARRIERS WITH YELLOW TREATMENT BUTTONS OR APPROVED TRACTILE WORKINGS STRIPS, 25 EA BUTTONS IN 4-45 SF

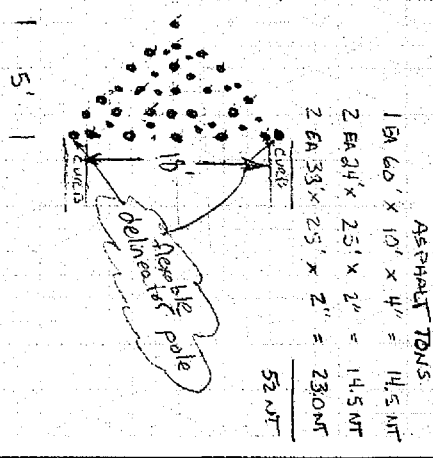

ASPHALT TONS  
 1 EA 60' x 10' x 4" = 14.5 NT  
 2 EA 24' x 25' x 2" = 14.5 NT  
 2 EA 33' x 25' x 2" = 23.0 NT  
 52 NT

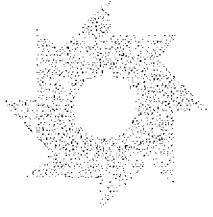

# SUNBELT RENTALS

www.sunbeltrentals.com

November 28, 2006

City of Independence

December

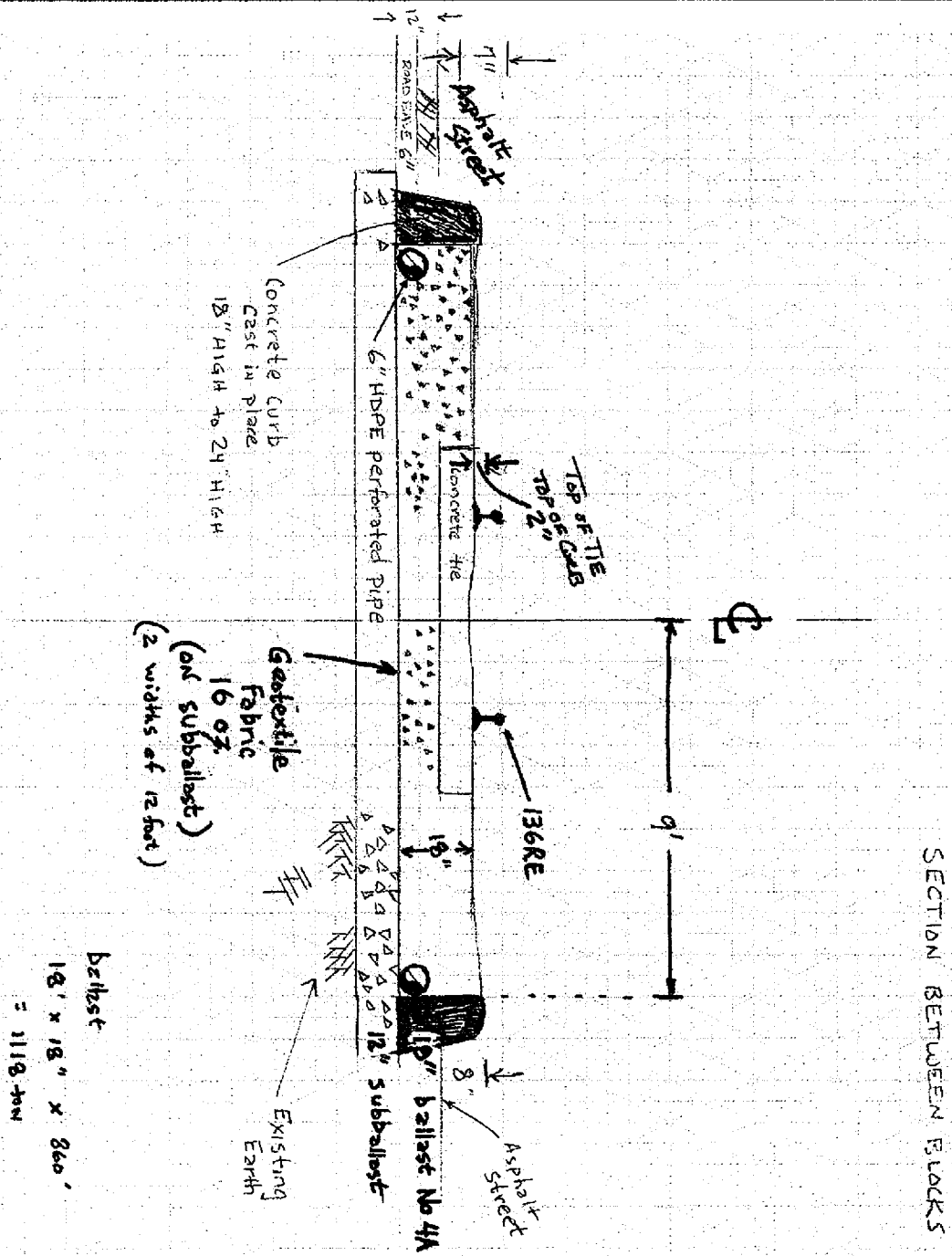

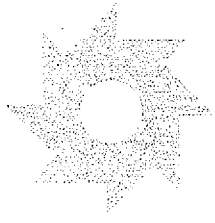

**SUNBELT**  
**RENTALS**  
www.sunbeltrentals.com

Nov. 29, 2006 INDEPENDANCE

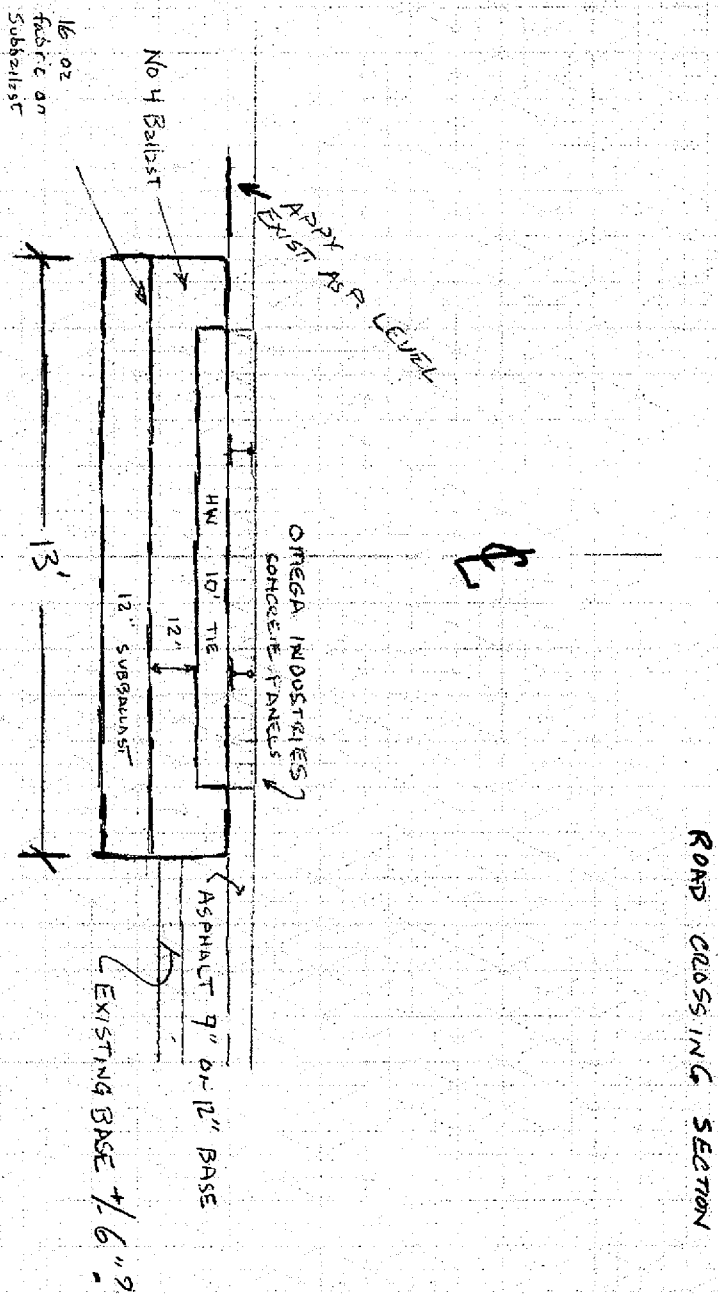

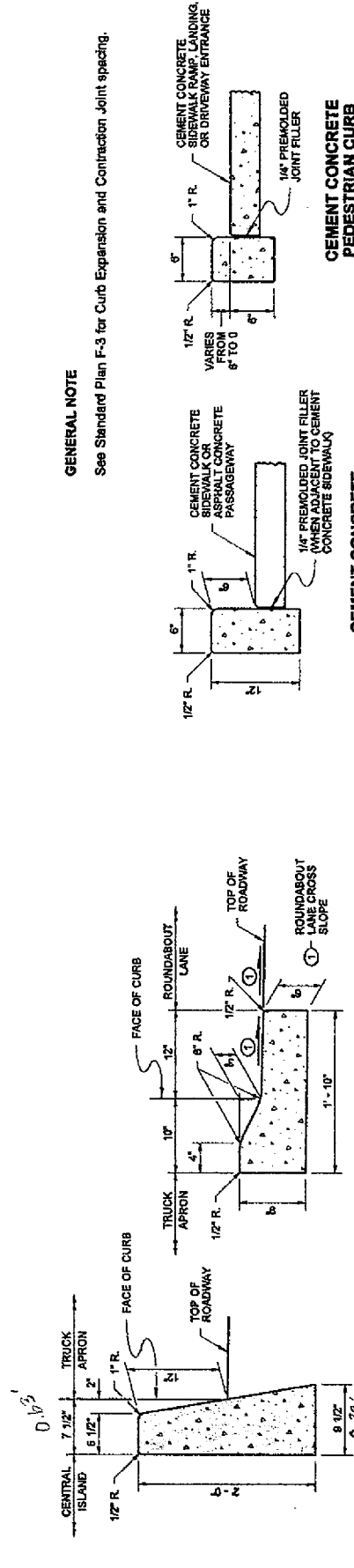

**GENERAL NOTE**  
See Standard Plan F-3 for Curb Expansion and Contraction Joint Spacing.

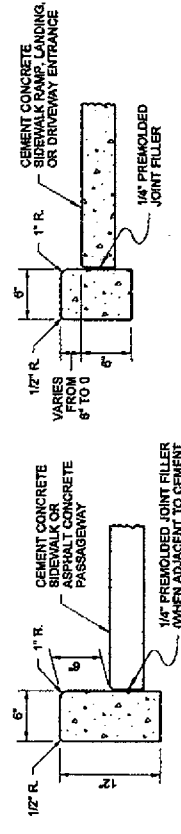

**CEMENT CONCRETE PEDESTRIAN CURB**  
AT SIDEWALK RAMPS & LANDINGS, AND DRIVEWAY ENTRANCES

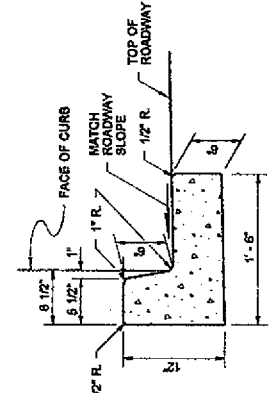
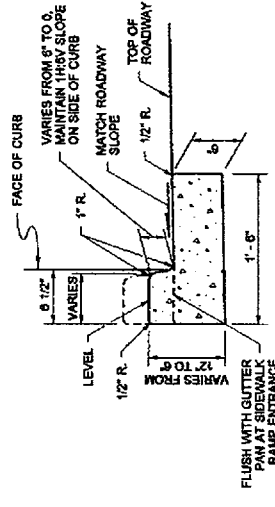

**CEMENT CONCRETE TRAFFIC CURB AND GUTTER**

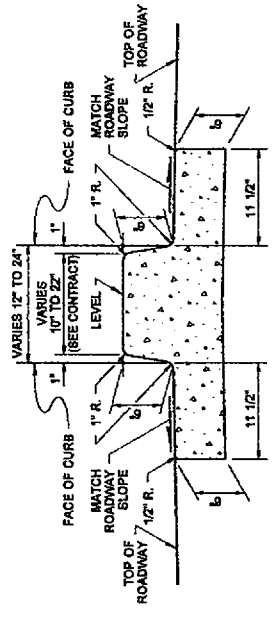

**DUAL-FACED CEMENT CONCRETE TRAFFIC CURB AND GUTTER**

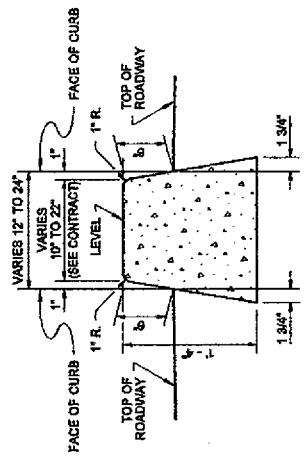

**DUAL-FACED CEMENT CONCRETE TRAFFIC CURB**

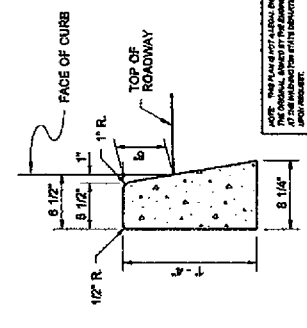

**CEMENT CONCRETE TRAFFIC CURB**

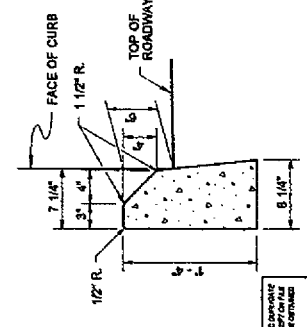

**MOUNTABLE CEMENT CONCRETE TRAFFIC CURB**



EXPIRES MAY 16, 2003

**CEMENT CONCRETE CURBS**  
**STANDARD PLAN F-1**

SHEET 1 OF 1 SHEET

APPROVED FOR PUBLICATION  
**Harold J. Peterfero** 12-17-02  
DATE  
STATE EXAMINER  
Washington State Department of Transportation