



Oregon

Theodore R. Kulongoski, Governor

Department of Land Conservation and Development

635 Capitol Street, Suite 150

Salem, OR 97301-2540

(503) 373-0050

Fax (503) 378-5518

www.lcd.state.or.us



NOTICE OF ADOPTED AMENDMENT

11/10/2011

TO: Subscribers to Notice of Adopted Plan
or Land Use Regulation Amendments

FROM: Plan Amendment Program Specialist

SUBJECT: Deschutes County Plan Amendment
DLCD File Number 002-11

The Department of Land Conservation and Development (DLCD) received the attached notice of adoption. A copy of the adopted plan amendment is available for review at the DLCD office in Salem and the local government office.

Appeal Procedures*

DLCD ACKNOWLEDGMENT or DEADLINE TO APPEAL: Monday, November 28, 2011

This amendment was submitted to DLCD for review prior to adoption pursuant to ORS 197.830(2)(b) only persons who participated in the local government proceedings leading to adoption of the amendment are eligible to appeal this decision to the Land Use Board of Appeals (LUBA).

If you wish to appeal, you must file a notice of intent to appeal with the Land Use Board of Appeals (LUBA) no later than 21 days from the date the decision was mailed to you by the local government. If you have questions, check with the local government to determine the appeal deadline. Copies of the notice of intent to appeal must be served upon the local government and others who received written notice of the final decision from the local government. The notice of intent to appeal must be served and filed in the form and manner prescribed by LUBA, (OAR Chapter 661, Division 10). Please call LUBA at 503-373-1265, if you have questions about appeal procedures.

***NOTE:** The Acknowledgment or Appeal Deadline is based upon the date the decision was mailed by local government. A decision may have been mailed to you on a different date than it was mailed to DLCD. As a result, your appeal deadline may be earlier than the above date specified. NO LUBA Notification to the jurisdiction of an appeal by the deadline, this Plan Amendment is acknowledged.

Cc: Kevin Harrison, Deschutes County
Jon Jinings, DLCD Community Services Specialist

<paa> N



FORM

2

DLCD

Notice of Adoption

This Form 2 must be mailed to DLCD within **5-Working Days after the Final Ordinance is signed** by the public Official Designated by the jurisdiction and all other requirements of ORS 197.615 and OAR 660-018-000

In person electronic mailed

DATE
NOV 04 2011

DEPT OF
LAND CONSERVATION
AND DEVELOPMENT See Only

Jurisdiction: Deschutes County

Local file number: TA-11-2

Date of Adoption: 10/31/11

Date Mailed: 11/3/11

Was a Notice of Proposed Amendment (Form 1) mailed to DLCD? Yes No Date: 7/28/11

Comprehensive Plan Text Amendment

Comprehensive Plan Map Amendment

Land Use Regulation Amendment

Zoning Map Amendment

New Land Use Regulation

Other:

Summarize the adopted amendment. Do not use technical terms. Do not write "See Attached".

Ord. No. 2011-018 amends DCC section 17.48 to correct errors, omissions and inconsistencies relating to design and construction standards in the County's Subdivision and Partition Ordinance.

Does the Adoption differ from proposal? Please select one NO

Plan Map Changed from: _____ to: _____

Zone Map Changed from: _____ to: _____

Location: _____ Acres Involved: _____

Specify Density: Previous: _____ New: _____

Applicable statewide planning goals:

- 1**
- 2**
- 3**
- 4**
- 5**
- 6**
- 7**
- 8**
- 9**
- 10**
- 11**
- 12**
- 13**
- 14**
- 15**
- 16**
- 17**
- 18**
- 19**

Was an Exception Adopted? YES NO

Did DLCD receive a Notice of Proposed Amendment...

45-days prior to first evidentiary hearing? Yes No

If no, do the statewide planning goals apply? Yes No

If no, did Emergency Circumstances require immediate adoption? Yes No

DLCD file No. 002-11 (18843) [16822]

Please list all affected State or Federal Agencies, Local Governments or Special Districts:

ODOT

Local Contact: Kevin Harrison Phone: 541)585 1401 Extension:
Address: 117 NW Lafayette Ave. Fax Number: 541-315-1764
City: Bend Zip: 97701 E-mail Address: kevinh@co.deschutes.or.us

ADOPTION SUBMITTAL REQUIREMENTS

This Form 2 must be received by DLCD no later than 5 days after the ordinance has been signed by the public official designated by the jurisdiction to sign the approved ordinance(s)
per ORS 197.615 and OAR Chapter 660, Division 18

1. This Form 2 must be submitted by local jurisdictions only (not by applicant).
 2. When submitting, please print this **Form 2** on light green paper if available.
 3. Send this Form 2 and One (1) Complete Paper Copy and One (1) Electronic Digital CD (documents and maps) of the Adopted Amendment to the address in number 6:
 4. **Electronic Submittals: Form 2 – Notice of Adoption will not be accepted via email or any electronic or digital format at this time.**
 5. The Adopted Materials must include the final decision signed by the official designated by the jurisdiction. The Final Decision must include approved signed ordinance(s), finding(s), exhibit(s), and any map(s).
 6. **DLCD Notice of Adoption must be submitted in One (1) Complete Paper Copy and One (1) Electronic Digital CD via United States Postal Service, Common Carrier or Hand Carried to the DLCD Salem Office and stamped with the incoming date stamp.** (for submittal instructions, also see # 5)] **MAIL the PAPER COPY and CD of the Adopted Amendment to:**
- ATTENTION: PLAN AMENDMENT SPECIALIST
DEPARTMENT OF LAND CONSERVATION AND DEVELOPMENT
635 CAPITOL STREET NE, SUITE 150
SALEM, OREGON 97301-2540**
7. Submittal of this Notice of Adoption must include the signed ordinance(s), finding(s), exhibit(s) and any other supplementary information (see ORS 197.615).
 8. Deadline to appeals to LUBA is calculated **twenty-one (21) days** from the receipt (postmark date) of adoption (see ORS 197.830 to 197.845).
 9. In addition to sending the Form 2 - Notice of Adoption to DLCD, please notify persons who participated in the local hearing and requested notice of the final decision at the same time the adoption packet is mailed to DLCD (see ORS 197.615).
 10. **Need More Copies?** You can now access these forms online at <http://www.lcd.state.or.us/>. You may also call the DLCD Office at (503) 373-0050; or Fax your request to: (503) 378-5518.

Updated December 22, 2009

REVIEWED

LEGAL COUNSEL

For Recording Stamp Only

BEFORE THE BOARD OF COUNTY COMMISSIONERS OF DESCHUTES COUNTY, OREGON

An Ordinance Amending Title 17, of the Deschutes County Code, To Make Minor Technical Changes *
* ORDINANCE NO. 2011-018

WHEREAS, the Deschutes County Road Department proposed a Text Amendment to Title 17, the Deschutes County Subdivision Ordinance, to make minor changes that will correct errors, omissions, inconsistencies, and clarify awkward text; and

WHEREAS, the Deschutes County Planning Commission held a duly noticed public hearing on August 25, 2011, and recommended to the Board the proposed changes to Title 17 as described in Exhibits "A" through "C"; and

WHEREAS, after notice and hearing as required by law, the Board of County Commissioners has considered the recommendation of the County Planning Commission; now, therefore,

THE BOARD OF COUNTY COMMISSIONERS OF DESCHUTES COUNTY, OREGON, ORDAINS as follows:

Section 1. AMENDMENT. DCC Chapter 17.48, Design and Construction Specifications, is amended to read as described in Exhibit "A," attached hereto and by this reference incorporated herein, with new language underlined and language to be deleted in ~~strike through~~.

Section 2. DCC Chapter 17.48 Appendix B, Table A and Table B remain unchanged by this ordinance.

Section 3. REPEAL AND REPLACE. Drawings, Standard Drawings, located in Title 17, Subdivisions, of the Deschutes County Code is hereby repealed and replaced by the revised Drawings as set forth in Exhibit "B," attached hereto and by this reference incorporated herein.

///

Section 4. FINDINGS. The Board adopts as its findings Exhibit "C", attached and incorporated by reference herein.

Dated this 31st of October 2011

BOARD OF COUNTY COMMISSIONERS
OF DESCHUTES COUNTY, OREGON

TAMMY BANEY, Chair

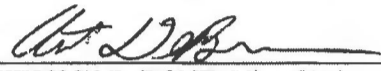
ANTHONY DeBONE, Vice Chair

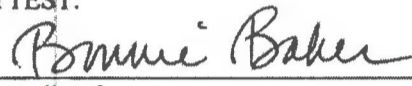
ATTEST:

Recording Secretary

ALAN UNGER, Commissioner

Date of 1st Reading: 12th day of Oct., 2011.

Date of 2nd Reading: 31st day of Oct., 2011.

Commissioner	Record of Adoption Vote:			
	Yes	No	Abstained	Excused
Tammy Baney	<input checked="" type="checkbox"/>	<input type="checkbox"/>	<input type="checkbox"/>	<input type="checkbox"/>
Anthony DeBone	<input checked="" type="checkbox"/>	<input type="checkbox"/>	<input type="checkbox"/>	<input type="checkbox"/>
Alan Unger	<input checked="" type="checkbox"/>	<input type="checkbox"/>	<input type="checkbox"/>	<input type="checkbox"/>

Effective date: 30th day of January, 2011. 2012

Chapter 17.48. DESIGN AND CONSTRUCTION SPECIFICATIONS

- 17.48.010. Minimum Standards Established.
- 17.48.020. Implementation of Requirements.
- 17.48.030. Additional Design Requirements.
- 17.48.040. Approval of Variations.
- 17.48.050. Road Design.
- 17.48.060. Improvement Plans.
- 17.48.070. Horizontal Alignment.
- 17.48.080. Vertical Alignment.
- 17.48.090. Intersections.
- 17.48.100. Minimum Right of Way Width.
- 17.48.110. Turn Lanes.
- 17.48.120. Partial Width Roads.
- 17.48.130. Road Names.
- 17.48.140. Bikeways.
- 17.48.150. Structures.
- 17.48.160. Road Development Requirements-Standards.
- 17.48.170. Road Development Requirements-Partitions.
- 17.48.175. Road Development Requirements-Unincorporated Communities.
- 17.48.180. Private Roads.
- 17.48.190. Drainage.
- 17.48.200. Surveying.
- 17.48.210. Access.
- 17.48.220. Driveways.
- 17.48.230. Utilities-Standards.
- 17.48.240. Utilities-Permit.
- 17.48.250. Utilities-Construction-Performance Standards.
- 17.48.260. Utilities-Construction-Excavation.
- 17.48.270. Utilities-Construction-Backfilling And Restoring.
- 17.48.280. Utilities-Construction-Inspection.
- 17.48.290. Fees.
- 17.48.300. Bonds.
- 17.48.310. Insurance.
- 17.48.320. Indemnification.
- 17.48.330. Construction-General Specifications.
- 17.48.340. Construction-Testing.
- 17.48.350. Construction-Inspection.
- 17.48.360. Construction-Handling Of Explosives.
- 17.48.370. Construction-Cooperation With Utilities.
- 17.48.380. Construction-Temporary Traffic Control.
- 17.48.390. Construction-Clearing And Grubbing.
- 17.48.400. Construction-Dust Control.
- 17.48.410. Construction-Subgrade Construction.
- 17.48.420. Construction-Surfacing Requirements.
- 17.48.430. Construction-Concrete Curb.
- 17.48.440. Construction-Sidewalks.
- 17.48.450. Construction-Slopes And Backfill.
- 17.48.460. Construction-Catchbasins.
- 17.48.470. Construction-Permanent Traffic Control.

- 17.48.480. Construction-Final Cleanup.
- 17.48.490. Road And Street Project.

17.48.010. Minimum Standards Established.

- A. Except as otherwise noted, the standard specifications for design and construction contained within DCC 17.48 and in the "Deschutes County Road Department Standard Drawings January 2011," adopted by Ordinance 2011-018 as Exhibit "B" and incorporated by reference herein, are the minimum standards governing construction of roads and other improvements and facilities.
 - B. The minimum standards governing construction of roads and other improvements and facilities within the Redmond Unincorporated Urban Growth Area shall be the standards and specifications set forth in the current "City of Redmond Public Works Standards and Specifications" which document is incorporated herein by reference.
 - C. Subject areas not covered by the Redmond Standards and Specifications shall continue to be covered by applicable provisions of DCC 17.48.
- (Ord. 2001-016 §1, 2001; Ord. 95-082 §4, 1995; Ord. 81-043 §1, Exhibit A, §8.010, 1981)

17.48.020. Implementation of Requirements.

- A. It is the duty of the Road Department Director ("Director"), or the Director's authorized representative, to implement the provisions and requirements of these standards in such a way as to carry out their intent and purpose.
 - B. For purposes of this chapter, all references to "Road Department Director" shall include the Director's authorized representative.
- (Ord. 2001-016 §1, 2001; Ord. 81-043 §1, Exhibit A, §8.015, 1981)

17.48.030. Additional Design Requirements.

The Road Department Director may impose additional design requirements as are reasonably necessary to protect the interests of the public.

(Ord. 2001-016 §1, 2001; Ord. 81-043 §1, Exhibit A, §8.020, 1981)

17.48.040. Approval of Variations.

- A. The Planning Director or Hearings Body may approve proposed variations in the improvement standards of up to 10 percent of the standards of DCC Title 17 at the time a tentative plat application is reviewed without the need for a variance to the standards provided the Planning Director or Hearings Body finds, after consultation with the County Road Department Director, that:
 - 1. There is no adverse impact to the public in allowing the variations;
 - 2. The variation promotes the intent and purposes of the ordinances; and
 - 3. There are practical difficulties that will create an unreasonable construction expense that will not result in a significant public benefit.
 - B. If a request for a variance from the standards is made after approval of a tentative plat and before the final plat, the applicant shall file a separate variance application, to be reviewed under the criteria set forth in DCC 17.48.040(A).
- (Ord. 2001-016 §1, 2001; Ord. 93-012 §47, 1993; Ord. 81-043 §1, Exhibit A, §8.700, 1981)

17.48.050. Road Design.

- A. The design of roads covered by DCC Title 17 is to be prepared by a registered professional engineer and shall at a minimum conform to the design standards for new or existing roads set forth in Table A of

DCC Title 17 (or in the design standards set forth for a particular zone in a zoning ordinance) and shall otherwise conform with AASHTO standards.

- B. Base and pavement dimensions set forth in Table A (or in specifications set forth for a particular zone) may be increased by the Road Department Director if necessitated by anticipated traffic volumes. (Ord. 2001-016 §1, 2001; Ord. 97-005 §4, 1997; Ord. 95-082 §5, 1995; Ord. 93-057 §1, 1993; Ord. 93-012 §48, 1993; Ord. 81-043 §1, Exhibit A, §8.110(1), 1981)

17.48.060. Improvement Plans.

- A. A complete set of certified mylar improvement plans shall be approved by the Road Department Director prior to the start of construction or the signing of the final plat.
- B. The improvement plans shall become the property of the County and will remain at the Road Department.
- C. The improvement plans which shall be 24 by 36 inches shall include, but not be limited to:
1. A plan view showing:
 - a. Centerline alignment showing points of curve and point of tangent stationing on all curves, necessary curve data and bearing of tangents,
 - b. Dimensioning necessary to survey and relocate the roadway,
 - c. Right of way lines as shown on the final plat,
 - d. Existing easements and recording references,
 - e. Type, location and size of all existing and proposed drainage and irrigation structures and utilities within the right of way,
 - f. Location and type of all existing and proposed signs and barricades,
 - g. Vicinity map showing the complete roadway network complete with names of roads,
 - h. Toe and fills and top of cuts,
 - i. Scale,
 - j. North arrow, and
 - k. Stamp and signature of the registered engineer;
 2. A profile showing:
 - a. Centerline grades and vertical curves, complete with point of intersection elevations and stations and length of vertical curves,
 - b. Original ground at centerline and extending 500 feet past the construction limits and at ditch lines if a significant transverse slope exists,
 - c. Curb profiles, where curbs are required,
 - d. Superelevation transition diagrams for horizontal curves if curbs are not required,
 - e. Type, location and size of all existing and proposed drainage and irrigation structures and utilities within the right of way, and
 - f. Scale;
 3. Typical roadway cross-section showing:
 - a. Width, depth and type of base,
 - b. Width, depth and type of paving,
 - c. Curbs, if required,
 - d. Side slopes,
 - e. Ditch section,
 - f. Crown slope, and
 - g. Utilities;
 4. Structural and detail plans of all structures, including, but not limited to, bridges, drainage structures, irrigation structures and sewer lines stamped by a registered engineer;
 5. A signature box with spaces provided for County approval and for approval by all affected utility companies and irrigation districts;

17.48.110. Turn Lanes.

When a turn lane is required, it shall be a minimum of 14 feet in width, except where road specifications in a zoning ordinance provide for travel lanes of lesser width. Additional right of way may be required. (Ord. 2001-016 §2, 2001; Ord. 97-005 §8, 1997; Ord. 81-043 §1, Exhibit A, §8.110(5), 1981)

17.48.120. Partial Width Roads.

Partial width roads or half streets shall not be allowed. (Ord. 2001-016 §2, 2001; Ord. 81-043 §1, Exhibit A, §8.110(5), 1981)

17.48.130. Road Names.

All roads shall be named in conformance with the provisions of the Deschutes County uniform road naming system set forth in DCC Title 16. (Ord. 2001-016 §1, 2001; Ord. 90-003 §1, Exhibit A, 1990; Ord. 81-043 §1, Exhibit A, §8.110(2), 1981)

17.48.140. Bikeways.

A. General Design Criteria.

1. Bikeways shall be designed in accordance with the current standards and guidelines of the Oregon (ODOT) Bicycle and Pedestrian Plan, the American Association of State Highway Transportation Officials (AASHTO) Guide for Development of New Bicycle Facilities, and the Deschutes County Bicycle Master Plan. See DCC 17.48 Table B.
2. All collectors and arterials shown on the County Transportation Plan map shall be constructed to include bikeways as defined by the Deschutes County Bicycle Master Plan.
3. If interim road standards are used, interim bikeways and/or walkways shall be provided. These interim facilities shall be adequate to serve bicyclists and pedestrians until the time of road upgrade.

B. Multi-use Paths.

1. Multi-use paths shall be used where aesthetic, recreation and safety concerns are primary and a direct route with few intersections can be established. If private roads are constructed to a width of less than 28 feet, multi-use paths shall be provided.
2. Multi-use paths are two-way facilities with a standard width of 10 feet, but with a 12-foot width if they are subjected to high use by multiple users. These paths shall meet County multi-use path standards and shall connect with bike facilities on public roads.

C. Bike Lanes. Six-foot bike lanes shall be used on new construction of curbed arterials and collectors.

D. Shoulder Bikeways.

1. Shoulder bikeways shall be used on new construction of uncurbed arterials and collectors.
2. Shoulder bikeways shall be at least four feet wide. Where the travel lane on an existing arterial or collector is not greater than eleven feet, the bikeway shall be a minimum of four feet wide.

E. Mountain Bike Trails.

1. Mountain bike (dirt or other unpaved surface) trails may be used as recreational or interim transportation facilities.
2. Trails used for transportation shall have a two-foot minimum tread width and a six-foot minimum clearing width centered over the trail, and a minimum overhead clearance of seven feet. Trails used solely for recreational use may be narrower with less clearing of vegetation.

(Ord. 2001-016 §1, 2001; Ord. 93-012 §49, 1993; Ord. 88-015 §4, 1988; Ord. 81-043 §1, Exhibit A, §8.110(3), 1981)

17.48.150. Structures.

All structures that carry a road or cross over a road shall be designed to have a 50-year life span. All designs must be approved by the Road Department Director and other affected public or private agencies.
(Ord. 2001-016 §1, 2001; Ord. 81-043 §1, Exhibit A, §8.110(10), 1981)

17.48.160. Road Development Requirements-Standards.

- A. Subdivision Standards. All roads in new subdivisions shall either be constructed to a standard acceptable for inclusion in the County maintained system or the subdivision shall be part of a special road district or a homeowners association in a planned unit development.
- B. Improvements of Public Rights of Way.
 - 1. The developer of a subdivision or partition will be required to improve all public ways that are adjacent or within the land development.
 - 2. All improvements within public rights of way shall conform to the improvement standards designated in DCC Title 17 for the applicable road classification, except where a zoning ordinance sets forth different standards for a particular zone.
- C. Primary Access Roads.
 - 1. The primary access road for any new subdivision shall be improved to the applicable standard set forth in Table A.
 - 2. The applicable standard shall be determined with reference to the road's classification under the relevant transportation plan.
 - 3. For the purposes of DCC 17.48.160 a primary access road is a road leading to the subdivision from an existing paved county, city or state maintained road that provides the primary access to the subdivision from such a road.
- D. Secondary Access Roads. When deemed necessary by the County Road Department or Community Development Department, a secondary access road shall be constructed to the subdivision. Construction shall be to the same standard used for roads within the subdivision.
- E. Stubbed Roads. Any proposed road that terminates at a development boundary shall be constructed with a paved cul-de-sac bulb.
- F. Cul-de-sacs.
 - 1. Cul-de-sacs shall have a length of less than 600 feet, unless a longer length is approved by the applicable fire protection district, and more than 100 feet from the center of the bulb to the intersection with the main road.
 - 2. The maximum grade on the bulb shall be four percent.
- G. Frontage Roads. Right of way widths shall be 40 feet when immediately adjacent to a main highway/arterial; 60 feet when the frontage road is separated from the highway or arterial by private land or as set forth for a particular zone in the zoning ordinance.
(Ord. 2001-016 §1, 2001; Ord. 98-004 §1, 1998; Ord. 97-005 §9, 1997; Ord. 93-057 §1, 1993; Ord. 93-012 §50, 1993; Ord. 81-043 §1, Exhibit A, §8.120(1)-(6), 1981)

17.48.170. Road Development Requirements-Partitions.

Roadway improvements within a partition and to a road maintained by a public agency shall be constructed prior to final approval of the partition, depending on the maximum parcel size as follows:

- A. For a parcel size of 10 acres or larger, the minimum road improvement standard shall be 20 feet wide with five inches of aggregate surfacing (cinders are acceptable), the centerline of which coincides with the centerline of the right of way;
- B. For a parcel size of less than 10 acres, the road standards used shall be the same as for a subdivision.
(Ord. 2001-016 §1, 2001; Ord. 93-012 §51, 1993; Ord. 81-043 §1, Exhibit A, §8.120(7), 1981)

17.48.175. Road Development Requirements - Unincorporated Communities.

A. Standards.

1. In the La Pine Urban Unincorporated Community , all roads shall be improved as specified for the applicable classification in Table A of DCC Title 17.
2. In the Terrebonne Rural Community, all improvements to public rights of way shall conform to the road development standards for Terrebonne in Table A of DCC Title 17, except for improvements to roads servicing parcels of 10 acres or greater created by a partition.
3. In the Tumalo Rural Community, all improvements to public rights of way shall conform to the Tumalo road development standards in Table A of DCC Title 17, except for improvements to roads servicing parcels of 10 acres or greater created by a partition.
4. In the Sunriver Urban Unincorporated Community, all roads shall conform to the road development standards in DCC 17.48.180.
5. No curbs or sidewalks are required in the Sunriver UUC or the rural service centers of Alfalfa, Brothers, Hampton, Millican, Whistle Stop, Wickiup Junction, Wild Hunt, Deschutes River Woods and Spring River.

B. All required road improvements shall be located on the applicant's side of the road, unless the subject property lies on both sides of the road.

(Ord. 2001-041 §2, 2001; Ord. 2001-016 §1, 2001; Ord. 98-004 §2, 1998; Ord. 97-035 §1, 1997; Ord. 97-005 §10, 1997; Ord. 96-003 §12, 1996; Ord. 93-057 §1, 1993; Ord. 93-012 §52, 1993)

17.48.180. Private Roads.

The following minimum road standards shall apply for private roads:

- A. The minimum paved roadway width shall be 20 feet in planned unit developments and cluster developments with two-foot wide gravel shoulders;
- B. Minimum radius of curvature, 50 feet;
- C. Maximum grade, 12 percent;
- D. At least one road name sign will be provided at each intersection for each road;
- E. A method for continuing road maintenance acceptable to the County;
- F. Private road systems shall include provisions for bicycle and pedestrian traffic.
 1. In cluster and planned developments limited to ten dwelling units, the bicycle and pedestrian traffic can be accommodated within the 20-foot wide road.
 2. In other developments, shoulder bikeways shall be a minimum of four feet wide, paved and striped, with no on-street parking allowed within the bikeway, and when private roads are developed to a width of less than 28 feet, bike paths constructed to County standards shall be required.

(Ord. 2004-025 §3, 2004; Ord. 2001-016 §1, 2001; Ord. 93-012 §53, 1993; Ord. 81-043 §1, Exhibit A, §8.130, 1981)

17.48.190. Drainage.

A. Minimum Requirements.

1. Drainage facilities shall be designed and constructed to receive and/or transport at least a design storm as defined in the Oregon Department of Transportation hydraulics current Central Oregon Stormwater Manual created by Central Oregon Intergovernmental Council and all surface drainage water coming to and/or passing through the development or roadway.
2. The system shall be designed for maximum allowable development.

B. Curbed Sections.

1. Storm drains within curbed streets shall have a minimum diameter of 18 inches and shall meet the current Standard Specifications for Public Works Construction — APWA Oregon Chapter designed per the requirements of the current Central Oregon Stormwater Manual created by the Central Oregon Intergovernmental Council.

2. Catchbasins shall be constructed in accordance with drawing Nos. 3-1, 3-2 and 3-3, 3-4 and 3-5.
(See drawings 3-1, 3-2 and 3-3, 3-4 3-5 set out at the end of DCC Title 17 and by this reference incorporated herein.)
- C. Noncurbed Sections.
1. Road culverts shall be concrete or metal with a minimum design life of 50 years.
 2. All cross culverts shall be 18 inches in diameter or larger.
 3. Culverts shall be placed in natural drainage areas and shall provide positive drainage.
- D. Drainage Swales. The Design Engineer is responsible to design a drainage swale adequate to control a design storm as defined in the ~~Oregon Department of Transportation hydraulics~~ Central Oregon Stormwater Manual created by Central Oregon Intergovernmental Council.
- E. Drainage Plans. A complete set of drainage plans including hydraulic and hydrologic calculations shall be incorporated in all road improvement plans.
- F. Drill Holes. Drill holes are prohibited.
- G. Injection wells (drywells) ~~are to be constructed to current DEQ standards and in accordance with drawing nos. 3-1 and 3-2 (see drawings 3-1 and 3-2 set out at the end of DCC Title 17 and by this reference incorporated herein.)~~ prohibited in the public right-of-way.
(Ord. 2011-018 §1, 2011; Ord. 2001-016 §1, 2001; Ord. 97-005 §11, 1997; Ord. 81-043 §1, Exhibit A, §8.140, 1981)

17.48.200. Surveying.

- A. Preliminary Procedures. All roads shall be staked prior to construction by a registered land surveyor on the horizontal and vertical alignments shown on the improvement plans.
- B. Cuts and Fills. Sections with a cut or fill and any superelevated sections shall be staked every 50 feet or less with:
1. A clearing lath; and
 2. Offset stakes marked with the offset distance and the cut or fill to the subgrade shoulder, except that offset stakes may be the same stakes as the clearing lath; and
 3. Shoulder lath for the aggregate base.
- D. Curbs. Curb sections shall require offset hubs every 25 feet with stakes marked with the offset distance and the cut or fill to the subgrade shoulder and the top of the curb.
- E. Centerline Monuments.
1. Centerline monuments, as approved by the Road Department Director, shall be installed at all centerline intersections where they fall in the paved section, point of curvatures and point of tangencies of each curve and at all centers of cul-de-sacs.
 2. All metal caps shall be stamped to identify the monument, i.e., P.I., P.C., P.T., Int, and carry the registration number of the surveyor or engineer setting the monument.
- (Ord. 2001-016 §1, 2001; Ord. 81-043 §1, Exhibit A, §8.300, 1981)

17.48.210. Access.

- A. Permit Required. Access onto public right of way or change in type of access shall require a permit. Permits are applied for at offices of the Community Development Department.
- B. Access Restrictions and Limitations. The creation of access onto arterials and collectors is prohibited unless there is no other possible means of accessing the parcel. In any event, residential access onto arterials and collectors shall not be permitted within 100 feet of an intersection or the maximum distance obtainable on the parcel, whichever is less.
- C. Commercial and Industrial Access.
1. Requirements for commercial and industrial access will be determined by the Road Department Director in accordance with DCC 17.48.090.
 2. Safety improvements, including left turn lanes and traffic signals, may be required.

D. Sight Distance. Access shall be denied at locations that do not meet AASHTO sight distance standards. (Ord. 2001-016 §1, 2001; Ord. 93-012 §53(A), 1993; Ord. 81-043 §1, Exhibit A, §8.400(1)-(4), 1981)

17.48.220. Driveways.

A. Access Width. The following are the maximum width of driveways:

Type	Width (in feet)
Residential	14(single), 20(double)
Agricultural	20
Commercial/Industrial	35

B. Culverts. Where culverts are required for driveways, the minimum pipe size shall be 12 inches.

C. Drainage. Driveways shall be constructed in such a manner that water, aggregate or any other substance that is hazardous to the traveling public will not enter ~~on roadway~~ onto the public right-of-way.

D. Construction. Construction of the driveway shall be in accordance with the design standards of the County Road Department.

(Ord. 2011-018 §1, 2011; Ord. 2001-016 §1, 2001; Ord. 81-043 §1, Exhibit A, §8.400(5)-(8), 1981)

17.48.230. Utilities-Standards.

A. Minimum Standards Established. In accordance with the provisions of ORS 374 and 758, DCC 17.48.240 through 17.48.280 set forth the minimum standards governing the placing, relocation, building, maintenance and construction of all facilities and appurtenances, upon public rights of way.

B. All utilities governed by DCC 17.48.240 through 17.48.280 shall be underground unless overhead utilities are permitted as a result of a land use action.

(Ord. 2011-018 §1, 2011; Ord. 2001-016 §1, 2001; Ord. 81-043 §1, Exhibit A, §8.500(1), 1981)

17.48.240. Utilities-Permit.

A. Prior to any work being done in a public right of way, a permit shall be obtained from the Road Department.

B. A minimum of two weeks prior to the desired commencement date of the project, the applicant shall deliver to the Road Department the following:

1. A completed permit on the Deschutes County Road Department standard form containing the following:
 - a. Applicant's name, address and telephone number;
 - b. Name, address and telephone number of the contractor and foreman or other person responsible for the work if different from the contractor;
 - c. Location of project, including:
 - i. Township, range and section,
 - ii. Road name,
 - iii. Nearest intersecting roads.
 - d. Type of facility;
 - e. The proposed starting and completion dates.
2. Two sets of construction plans showing all pertinent construction details;
3. A plan for traffic control; in the case of a road closure, a proposed detour and/or other method of controlling traffic;
4. A bond or cash deposit as required in DCC 17.48.300, ~~with an improvement agreement in a form approved by the Road Department Director.~~

BC. Road Department Approval.

One set of the documents described in DCC 17.48.240(A) shall be signed by the Road Department Director and returned to the applicant together with any necessary supplemental instructions.

1. The approved documents and supplemental instructions shall become a part of the permit and be binding on the applicant.

CD. Permit Conditions.

1. In granting any permit, the Road Department Director may attach such other conditions thereto as may be reasonably necessary to prevent damage to public or private property or to prevent the operation from being conducted in a manner hazardous to life or property or in a manner likely to create a nuisance.

2. Such conditions may include but shall not be limited to:

- 1a. Limitations on the period of the year in which the work may be performed;
- 2b. Restrictions as to the size and type of equipment;
- 3c. Designation of routes upon which material may be transported;
- 4d. The place and manner of disposal of excavated material;
- 5e. Requirements as to the control of dust, the cleaning of streets, the prevention of noise and other results offensive or injurious to the neighborhood, the general public or any portion thereof; and
- 6f. Regulations as to the use of roads in the course of the work.

(Ord. 2011-018 §1, 2011; Ord. 2001-016 §1, 2001; Ord. 93-012 §53(AA), 1993; Ord. 81-043 §1, Exhibit A, §8.500(2), 1981)

17.48.250. Utilities-Construction- Performance Standards.

A. The work to be performed under this permit shall be carried out in accordance with the current ~~Standard Specifications and Drawings for Public Works Construction by the Oregon Chapter of the American Public Works Association (APWA)~~ Deschutes County Standards in DCC Title 17 and the current ODOT/APWA Oregon Standard Specifications for Construction and in accordance with drawing nos. 1-1, 1-2, ~~and 1-3 and 1-4~~ (see drawings 1-1, 1-2, ~~and 1-3 and 1-4~~ set out at the end of DCC Title 17 and by this reference incorporated herein.).

B. Work authorized by a permit shall be performed between the hours of ~~eight-seven~~ eight a.m. and ~~four-five~~ five p.m., Monday through Friday.

C. Access to private driveways shall be provided except during working hours when construction operations prohibit provision of such access.

D. Free access must be provided at all times to fire hydrants.

E. Monuments.

1. Monuments of concrete, iron or other lasting materials set out for the purpose of locating or preserving the lines of any street or property subdivision, or precise survey reference point, or a permanent survey bench mark within the County shall not be removed or disturbed or caused to be removed or disturbed unless permission to do so is first obtained in writing from the County surveyor.

2. Permission shall be granted only upon condition that the applicant shall pay all expenses incidental to the proper replacement of the monument.

(Ord. 2011-018 §1, 2011; Ord. 2001-016 §1, 2001; Ord. 81-043 §1, Exhibit A, §8.500(3)(A), 1981)

17.48.260. Utilities-Construction-Excavation.

A. The minimum cover between the top of a buried utility and road or ground surface shall be 30 inches.

B. Where practical, underground utilities shall be jacked, pushed, bored or washed under roads when crossing same.

BC. No opening or excavation in any road shall extend beyond the centerline of the road before being backfilled and the surface of the road temporarily restored.

CD. No more than ~~250~~300 feet of trench, measured longitudinally, shall be opened along a road at one time.

DE. Excavated materials shall be laid compactly along the side of the trench and kept trimmed so as to cause as little inconvenience as possible to public travel.

~~EF.~~ All utility facilities shall be located sufficiently ahead of trench excavation work to avoid damage to those facilities and to permit their relocation, if necessary.

(Ord. 2011-018 §1, 2011; Ord. 2001-016 §2, 2001; Ord. 81-043 §1, Exhibit A, §8.500(3)(B), 1981)

17.48.270. Utilities-Construction-Backfilling and Restoring.

A. All backfilled material shall be compacted to 95 percent of its relative maximum density when within the roadway to 90 percent when between the shoulder (or curb) and the right of way line.

B. Trenches shall be backfilled as follows:

A1. Unimproved Roads and Area Outside Roadway. The trench shall be backfilled with the excavated or other suitable materials and the entire backfill shall be compacted in layers of not to exceed six inches by use of a mechanical tamper.

B2. Aggregate Surfaces. The trench shall be backfilled according to drawing no. 1-3 (see drawing no. 1-3 set out at the end of DCC Title 17 and by this reference incorporated herein.).

C3. Paved Surfaces. The trench shall be backfilled according to drawing nos. 1-1, ~~and 1-2~~ and 1-4 (see drawing nos. 1-1, ~~and 1-2~~ and 1-4 set out at the end of DCC Title 17 and by this reference incorporated herein.).

(Ord. 2011-018 §1, 2011; Ord. 2001-016 §1, 2001; Ord. 81-043 §1, Exhibit A, §8.500(3)(C), 1981)

17.48.280. Utilities-Construction-Inspection.

A. The Oregon Utility Notification Center shall be notified at 1-800-332-2344 two working days in advance of any excavation. The Road Department shall be notified two working days in advance of the time of backfilling.

B. Costs.

1. All inspection costs shall be borne by the applicant.

2. Such costs shall be based on a schedule of charges on file in the Road Department Building, 61150 SE 27th Street, Bend, Oregon 97702, (541) 388-6581.

(Ord. 2001-016 §1, 2001; Ord. 81-043 §1, Exhibit A, §8.500(3)(D), 1981)

17.48.290. Fees.

All plan review and field inspection costs shall be borne by the applicant. Such costs shall be based on a schedule of charges on file in the Road Department.

(Ord. 2001-016 §1, 2001; Ord. 81-043 §1, Exhibit A, §8.610, 1981)

17.48.300. Bonds.

A. Required. When, in the opinion of the Road Department Director, an existing public way is endangered by an applicant, such applicant shall be required to file an agreement and security with the County.

B. Type of Security. The applicant shall file with the agreement, to assure the applicant's full performance thereof, one of the following:

1. A surety bond executed by a surety company authorized to transact business in the state in a form approved by the County; or

2. Cash.

C. Amount Required. Such assurance of full performance shall be for a sum approved by the Road Department Director as sufficient to cover the cost of improvements and repairs, including related engineering, inspection and incidental expenses.

D. Default Status.

1. If the applicant fails to carry out provisions of the agreement and the County has unreimbursed costs or expenses resulting from such failure, the County shall call on the bond or cash deposit for reimbursement.

2. If the amount of the bond or cash deposit exceeds the cost and expense incurred by the County, it shall release the remainder.
 3. If the amount of the bond or cash deposit is less than the cost and expense incurred by the County, the applicant shall be liable to the County for the difference.
- E. Expiration. The bond shall not be released by the County until one year from the improvement completion date specified by the applicant.
- F. The bonds shall not be released by the County until County inspectors have inspected the improvements and approved them in writing.
- (Ord. 2001-016 §1, 2001; Ord. 81-043 §1, Exhibit A, §8.620, 1981)

17.48.310. Insurance.

The licensee shall procure and continue to carry during the term of the license, public liability and property damage insurance in a responsible company, with limits of not less than one million dollars combined single limit.

(Ord. 2001-016 §1, 2001; Ord. 81-043 §1, Exhibit A, §8.640, 1981)

17.48.320. Indemnification.

- A. The licensee shall be responsible and liable for all injuries to other persons or property resulting from any negligence or otherwise tortious acts or omissions of the licensee, its servants or agents.
 - B. The licensee shall indemnify the County and hold it harmless against any and all claims, demands, lawsuits, injuries, damages or costs, including litigation costs, which the County may sustain by reason of any such acts or omissions.
- (Ord. 2001-016 §1, 2001; Ord. 81-043 §1, Exhibit A, §8.630, 1981)

17.48.330. Construction-General Specifications.

- A. Unless otherwise detailed in DCC 17.48, all roadway excavation, fill construction, subgrade preparation, aggregate base, surfacing, prime coats and paving will be done in accordance with the ~~1984 Edition of Oregon State Highway Division's Standard Specifications for Highway Construction~~ current edition of the ODOT/APWA Oregon Standard Specifications for Construction, hereinafter referred to as the general specifications.
 - B. Whenever these specifications refer to the state, they shall be taken to mean the County, the appropriate County address, and likewise, reference to the commission or the engineer shall be taken to mean the Board of County Commissioners or the Road Department Director.
- (Ord. 2011-018 §1, 2011; Ord. 2001-016 §1, 2001; Ord. 88-017 §1, 1988; Ord. 81-043 §1, Exhibit A, §8.200(2), 1981)

17.48.340. Construction-Testing.

All testing shall conform to methods described in the current edition of the AASHTO Materials, Part II, Tests, 1993 Edition, or the current edition of the Oregon State Highway Division Laboratory Manual of Test Procedure, 1993 Edition.

(Ord. 2011-018 §1, 2011; Ord. 2001-016 §2, 2001; Ord. 93-012 §53(AAA), 1993; Ord. 81-043 §1, Exhibit A, §8.200(2), 1981)

17.48.350. Construction-Inspection.

- A. The Road Department shall be notified two working days in advance of the time for subgrade inspection, two working days in advance of the time for base inspection and two working days in advance of the time for paving inspection.

B. Each stage of construction must be inspected and approved prior to the commencement of the next stage of construction. The final inspection shall be requested seven working days in advance.
(Ord. 2001-016 §1, 2001; Ord. 81-043 §1, Exhibit A, §8.200(3), 1981)

17.48.360. Construction-Handling of Explosives.

In the handling of explosives, the contractor must comply with federal, state and local laws, and the County will in no way be responsible for any noncompliance therewith or for damages to property or injury to persons resulting from accidental or premature explosions.
(Ord. 2001-016 §1, 2001; Ord. 81-043 §1, Exhibit A, §8.200(4), 1981)

17.48.370. Construction-Cooperation with Utilities.

- A. The contractor shall, at least 24 hours in advance of performing any work in the immediate vicinity of utility lines, contact the utilities to request the location and marking of buried utility facilities.
 - B. The County is covered by the Oregon Utility Notification Center, which has been set up on a one-call system for notifying all owners of utilities of work being performed in the vicinity of their facilities.
 - C. The one call system telephone number is 1-800-332-2344.
- (Ord. 2001-016 §1, 2001; Ord. 81-043 §1, Exhibit A, §8.200(5), 1981)

17.48.380. Construction-Temporary Traffic Control.

- A. Temporary protective and directional measures for traffic control shall be in conformance with the Federal Highway Administration's current Manual on Uniform Traffic Control Devices.
 - B. The contractor shall be required to allow one-way traffic through the project during working hours.
 - 1. However, one-way traffic operation will not be permitted until such time as the contractor has labor, equipment and materials on the project necessary to proceed without delaying the work.
 - 2. Once one-way traffic is established, the contractor shall perform the construction work in a continuous and efficient manner.
 - C. Contact Person.
 - 1. The contractor shall have a person on the job during working hours and on-call at all other times, who shall have the responsibility to maintain all directional and warning devices in proper position.
 - 2. The County will be provided with the name and telephone number of such person.
- (Ord. 2001-016 §1, 2001; Ord. 81-043 §1, Exhibit A, §8.200(6), 1981)

17.48.390. Construction-Clearing and Grubbing.

All work shall be performed in accordance with section ~~20100320~~ of the ~~General-current~~ Specifications ODOT/APWA Oregon Standard Specifications for Construction supplemented and/or modified as follows:

- A. The right of way shall be cleared of all fixed objects.
- B. However, in developments where traffic safety would not be involved, and a lesser requirement would not create a hazard, the right of way shall be cleared a minimum of 40 feet or four feet beyond the edge of the shoulder or curb line of the finished road.

(Ord. 2011-018 §1, 2011; Ord. 2001-016 §2, 2001; Ord. 81-043 §1, Exhibit A, §8.200(7), 1981)

17.48.400. Construction-Dust Control.

- A. The work shall consist of the furnishing and applying of water for the alleviation or prevention of dust nuisance in accordance with section ~~23300280~~ of the ~~General-current~~ Specifications ODOT/APWA Oregon Standard Specifications for Construction.
- B. Responsibility for dust abatement will be the contractor's.
- C. Watering will be done when ordered by the Road Department Director.
- D. The contractor shall supply the applicant's own water source.

(Ord. 2011-018 §1, 2011; Ord. 2001-016 §1, 2001; Ord. 81-043 §1, Exhibit A, §8.200(8), 1981)

17.48.410. Construction-Subgrade Construction.

- A. All work shall be performed in accordance with section ~~20300330~~ of the ~~General-current Specifications~~ ODOT/APWA Oregon Standard Specifications for Construction, supplemented and/or modified as follows:
1. Excavated materials not required nor suitable for filling and backfilling, within the limits of the project, will be classed as excess materials and shall become the property of the contractor at the point of excavation and shall be disposed of by him at a location and in a manner satisfactory to the Road Department.
 2. In the event rock is encountered in excavation, the rock will be excavated to a depth not less than six inches below subgrade, and then backfilled with suitable material.
- B. Material shall be considered unsuitable for fill, subgrade, shoulders and other uses if it contains organic matter, soft spongy earth or other material of such nature that compaction to the specified density is unobtainable.
- C. No material having a maximum dimension of three inches or more shall be considered suitable for fill material in the top one foot of subgrade, including the fill side slopes.
- D. Compaction shall be a minimum of 95 percent of the relative maximum density.

(Ord. 2011-018 §1, 2011; Ord. 2001-016 §2, 2001; Ord. 81-043 §1, Exhibit A, §8.200(9), 1981)

17.48.420. Construction-Surfacing Requirements.

- A. Aggregate Base.
1. Crushed aggregate meeting the requirements of section ~~703-0702630~~ of the ~~General-current Specifications~~ ODOT/APWA Oregon Standard Specifications for Construction shall be used.
 2. All work shall be performed in accordance with section ~~304640~~ of the ~~General-current Specifications~~ ODOT/APWA Oregon Standard Specifications for Construction.
 3. ~~In the case of a rural local road or a primary access road, three inch minus cinder aggregate from a source approved by the Road Department Director is allowable.~~
- B. Asphalt Prime Coat. For all roadway sections using an asphalt penetration macadam, an asphalt prime coat will be applied to the aggregate base in accordance with section ~~40800700~~ of the ~~General-current Specifications~~ ODOT/APWA Oregon Standard Specifications for Construction and in accordance with drawing no. 2-9 (see drawing 2-9 set out at the end of DCC Title 17 and by this reference incorporated herein.).
- C. Asphalt Penetration Macadam. When an oil mat is placed, it shall be applied in accordance with section ~~40600715~~ of the ~~General-current Specifications~~ ODOT/APWA Oregon Standard Specifications for Construction and in accordance with drawing no. 2-9 (see drawing 2-9 set out at the end of DCC Title 17 and by this reference incorporated herein.).
- D. Asphaltic Concrete Pavement.
1. Where asphaltic concrete pavement is required, it shall be placed in accordance with section ~~40300745~~ of the ~~General-current Specifications~~ ODOT/APWA Oregon Standard Specifications for Construction.
 2. The asphalt cement shall be as required by the Road Department Director.
 3. The class of asphaltic concrete shall be ~~Class C~~ Level 3 HMAC.
 4. A mix design shall be submitted to the Road Department Director at least one week prior to paving.
- E. Tack Coat. When a tack coat is required by the Road Department Director, the tack coat shall be applied in conformance with section ~~40700730~~ of the ~~current General Specifications~~ ODOT/APWA Oregon Standard Specifications for Construction.
- F. Portland Cement Concrete Pavement. When portland cement concrete pavement is used, it shall be designed and constructed in accordance with the publications of the Portland Cement Association.

(Ord. 2011-018 §1, 2011; Ord. 2001-016 §1, 2001; Ord. 93-012 §53(B), 1993; Ord. 81-043 §1, Exhibit A, §8.200(10)-(15), 1981)

17.48.430. Construction-Concrete Curb.

A. Where required, portland cement concrete curbs shall be constructed in accordance with drawing No. 2-2 (See drawing 2-2 set out at the end of DCC Title 17 and by this reference incorporated herein.) and section ~~60900759~~ of the ~~General-current Specifications~~ ODOT/APWA Oregon Standard Specifications for Construction.

B. The concrete shall be class ~~33000~~ as specified in section ~~504~~ of the ~~General Specifications.~~
(Ord. 2011-018 §1, 2011; Ord. 2001-016 §1, 2001; Ord. 81-043 §1, Exhibit A, §8.200(16), 1981)

17.48.440. Construction-Sidewalks.

A. Sidewalks shall be constructed with Class ~~33000~~ concrete as specified in section ~~504~~ of the ~~General current Specifications~~ ODOT/APWA Oregon Standard Specifications for Construction.

B. The concrete shall be in accordance with drawing No. 2-6. (See drawing 2-6 set out at the end of DCC Title 17 and by this reference incorporated herein.) Sidewalks shall not be less than five feet wide.
(Ord. 2011-018 §1, 2011; Ord. 2001-016 §1, 2001; Ord. 81-043 §1, Exhibit A, §8.200(17), 1981)

17.48.450. Construction-Slopes and backfill.

- A. Curb and sidewalk backfill material shall be good quality topsoil.
 - B. The material shall be spread accurately and smoothly within the public right of way.
 - C. Topsoil shall be suitable silty sand from an approved source, containing no rock or gravel larger than three-fourths inch and at least 70 percent of material passing a No. 4 U.S. Standard sieve size.
 - D. It shall be free of roots, sticks, seeds and other noxious vegetation.
- (Ord. 2001-016 §2, 2001; Ord. 81-043 §1, Exhibit A, §8.200(18), 1981)

17.48.460. Construction-Catchbasins.

Catchbasins shall be constructed of class ~~33000~~ portland cement concrete and in accordance with drawing Nos. ~~3-31~~, ~~3-42~~ and ~~3-53~~. (See drawings ~~3-31~~, ~~3-42~~ and ~~3-53~~ set out at the end of DCC 17. and by this reference incorporated herein.)

(Ord. 2011-018 §1, 2011; Ord. 2001-016 §1, 2001; Ord. 81-043 §1, Exhibit A, §8.200(19), 1981)

17.48.470. Construction-Permanent Traffic Control.

~~Signs shall comply with Appendix B. (See Appendix B set out at the end of DCC Title 17.) Signing at intersections shall be procured and installed at the expense of the developer. All traffic control devices required by the Road Department Director shall be procured and installed by the developer and shall meet the requirements of the current Federal Highway Administration's Manual on Uniform Traffic Control Devices ("MUTCD").~~

(Ord. 2001-016 §1, 2001; Ord. 81-043 §1, Exhibit A, § 8.200(20), 1981)

17.48.480. Construction-Final Cleanup.

- A. Final cleanup shall consist of pulling the shoulders and dressing of the earthwork side slopes.
 - B. Any material pulled onto the pavement is to be broomed off.
 - C. The roadway side slopes are to be raked to remove all equipment tracks and berms.
- (Ord. 2001-016 §2, 2001; Ord. 81-043 §1, Exhibit A, §8.200(21), 1981)

17.48.490. Road and Street Project.

- A. **Subdivision Standards Applicable.** Design and construction standards set forth in DCC 17.48 are applicable to all road and street projects.
- B. **Land Use Permit Required.** A land use permit shall be required for any Class I or Class II road and street project. No land use permit shall be required for a Class III road and street project. The road project shall be reviewed against the applicable comprehensive plan Transportation Plan element and the following standards:
 - 1. Compatibility with existing land use and social patterns, including noise generation, safety hazards (e.g. children in a residential area), and zoning.
 - 2. Environmental impacts, including hazards imposed to and by wildlife (e.g. migration or water use patterns).
 - 3. Retention of scenic quality, including tree preservation.
 - 4. Means to improve the safety and function of the facility, including surrounding zoning, access control and terrain modifications.
 - 5. In the case of roadways where modification results in a change of traffic types or density, impacts on route safety, route land use patterns, and route nonmotorized/pedestrian traffic.
 - 6. Consideration of the potential developmental impact created by the facility.
 - 7. Cost-effectiveness.
- C. **Bicycle Facilities.** Bicycle facilities consisting of a portion of the paved roadway and designated by striping, signing and pavement markings for the preferential or exclusive use of bicyclists, shall be constructed in conjunction with a road and street project if the project involves the new construction, modernization, reconstruction or major alteration of an arterial or collector to the adopted County road standards.
- D. **Sidewalks.** Sidewalks shall be required in conjunction with a road and street project in accordance with DCC 12.35.100, Developed Area Sidewalks.
(Ord. 2001-016 §1, 2001; Ord. 93-012 §54, 1993; Ord. 88-015 §5, 1988)



DESCHUTES COUNTY ROAD DEPARTMENT
STANDARD DRAWINGS
JANUARY 2011

TABLE OF CONTENTS

DRAWING	TITLE
UTILITIES	
1-1	TRENCH IN EXISTING PAVEMENT
1-2	TRENCH DEPTH AND VICINITY MAP
1-3	STANDARD UTILITY TRENCH DETAIL - ALL WEATHER SURFACE ROAD
1-4	UTILITY TRENCH IN PAVEMENT LESS THAN 5 YRS OLD
1-5	STREET LIGHTING
STREETS	
2-1	ALL WEATHER SURFACE ROAD - PARTITION STANDARD
2-2	CONCRETE CURB
2-3	CONCRETE DRIVEWAY APRONS AND CURB CUTS, OPTION "A"
2-4	CONCRETE DRIVEWAY APRONS AND CURB CUTS, OPTION "B"
2-5	SIDEWALK & CURB RAMPS
2-6	TYPICAL CONCRETE CURB & SIDEWALK DETAILS
2-7	CLUSTER POSTAL DELIVERY BOX PARKING BAY
2-8	"T" INTERSECTION ALIGNMENT STANDARD
2-9	ASPHALT PENETRATION MACADAM (OIL MAT) SPECIFICATIONS
DRAINAGE	
3-1	STANDARD CATCH BASIN, DOUBLE & SINGLE
3-2	SIDEWALK CATCH BASIN
3-3	STANDARD CATCH BASIN GRATE
3-4	DRAINAGE SWALES

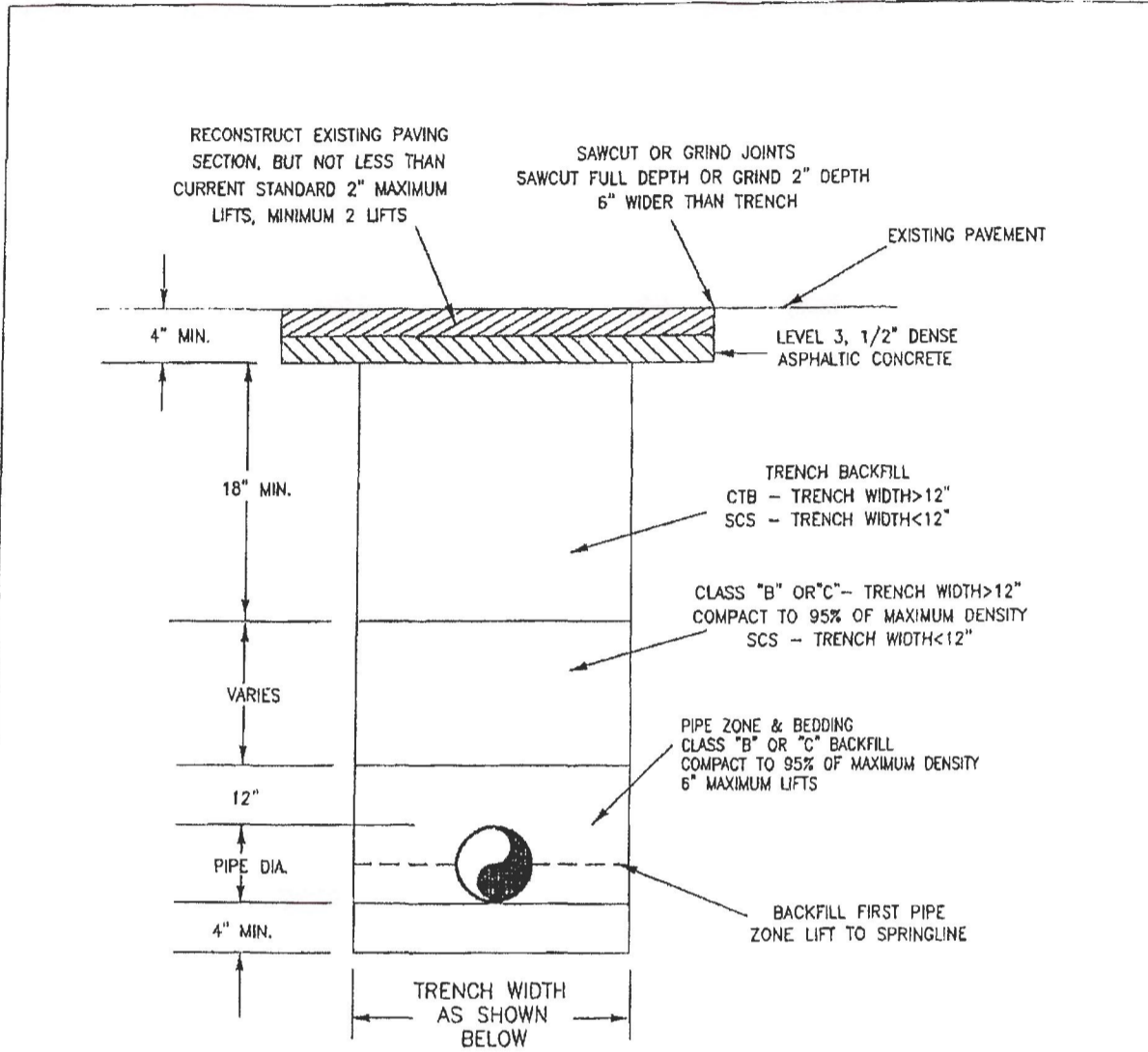

Pipe Size I.D. less than 6"	Max. Width	Min. Width
6"	30"	24"
8"	36"	27"
10"	42"	30"
12"	42"	30"
15"	44"	36"
18"	48"	38"

Class "B" Backfill: 3/4"-0 aggregate base. Reject base material may be used on approval by the Engineer.

Class "C" Backfill: Clean sand with no particles size larger than 1/4" and no more than 10% by weight of material passing a 200 sieve

Cement Treated Base (CTB): Shall conform to the requirement of ODOT. It shall contain 4.5% to 5.5% cement by weight (1 to 2 sacks cement/ton)

Sand Cement Slurry (SCS): Shall conform to the requirements of ODOT specification for Class B bedding. It shall consist of at least 3/4 sack of portland cement/cubic yard of sand plus water, with a 7-inch slump plus or minus 1-1/2 inches.

J:\CAC\Projects\DC Standards\1-1.dwg

DATE :	SCALE :	UTILITY TRENCH IN EXISTING PAVEMENT	DESCHUTES COUNTY ROAD DEPARTMENT	
1/10/2010	NONE			
DRAWING NO.	APPROVED BY :			
1-1	G.KOLB			

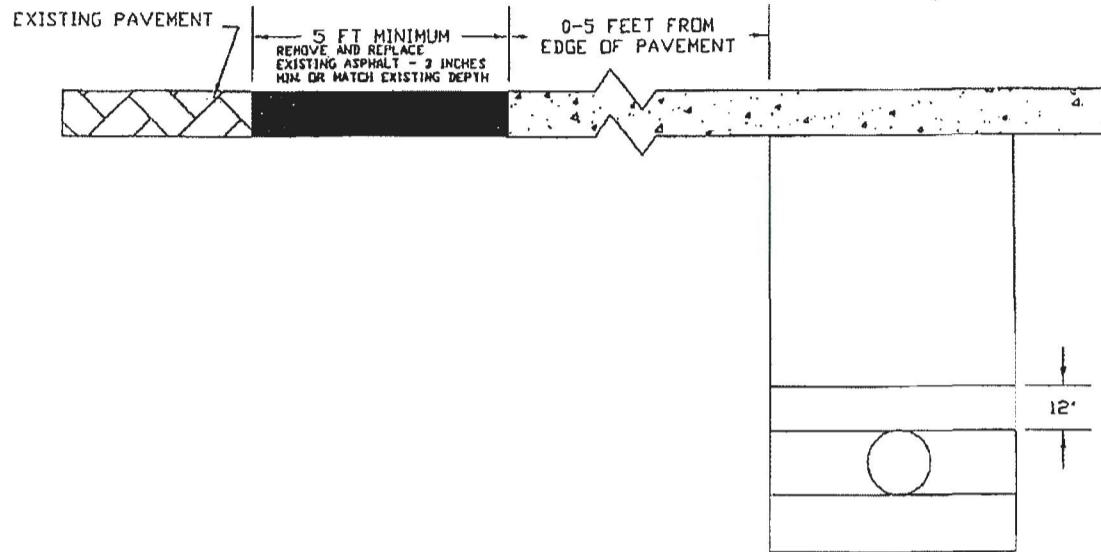

FOR LONGITUDINAL TRENCH 0 - 5 FEET FROM EDGE OF PAVEMENT

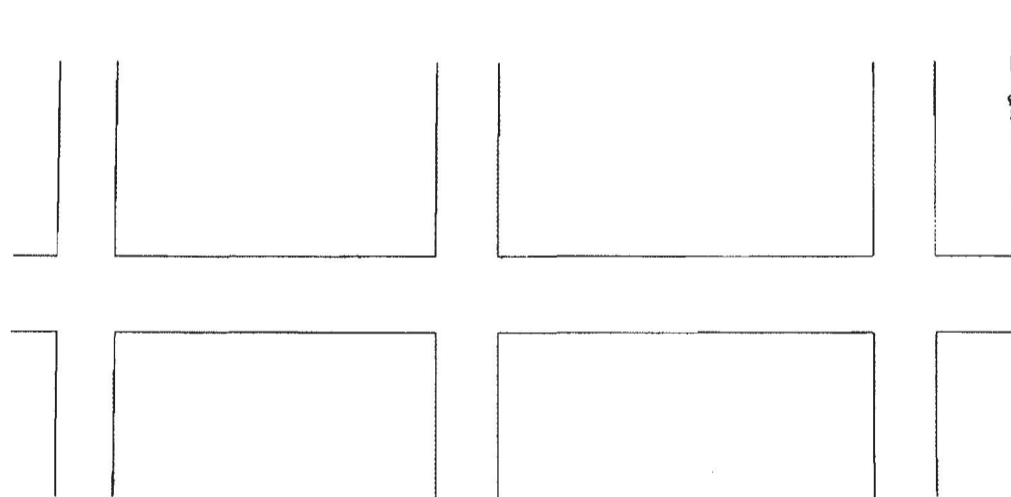

VICINITY MAP

J:\CAD\Projects\DC Standards\deg\1-2.dwg

DATE :	SCALE :	TRENCH DEPTH AND VICINITY MAP	DESCHUTES COUNTY ROAD DEPARTMENT 
1/10/2010	NONE		
DRAWING NO.	APPROVED BY :		
1-2	G.KOLB		

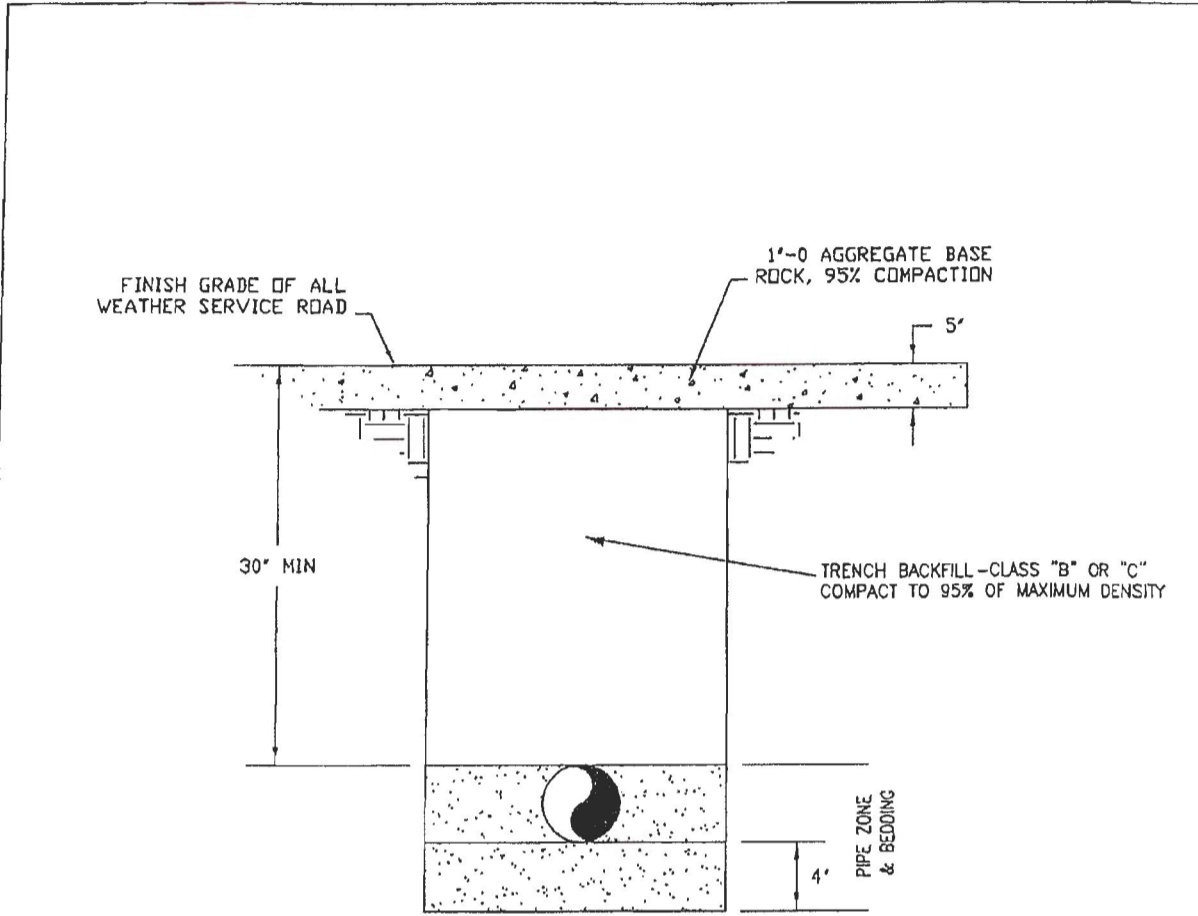

Class "B" Backfill: 3/4"-0 aggregate base. Reject base material may be used on approval by the Engineer.
 Class "C" Backfill: Clean sand with no particles size larger than 1/4" and no more than 10% by weight of material passing a 200 sieve

J:\CAD\Projects\DC Standards\dwg\1-3.dwg

DATE :	SCALE :	STANDARD UTILITY TRENCH DETAIL ALL WEATHER SURFACE ROAD	DESCHUTES COUNTY ROAD DEPARTMENT	
3/14/11	NONE			
DRAWING NO.	APPROVED BY :			
1-3	G.KOLB			

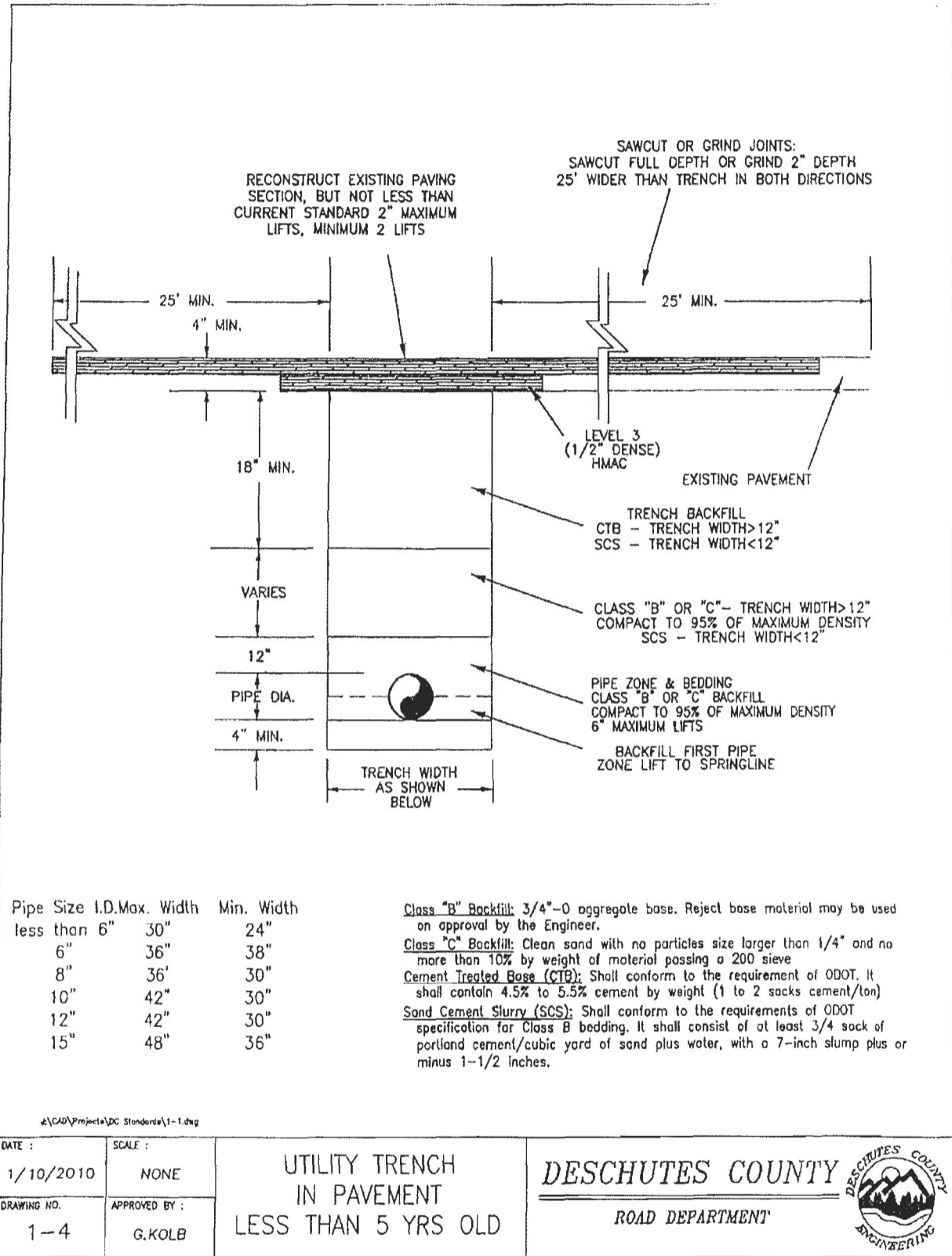

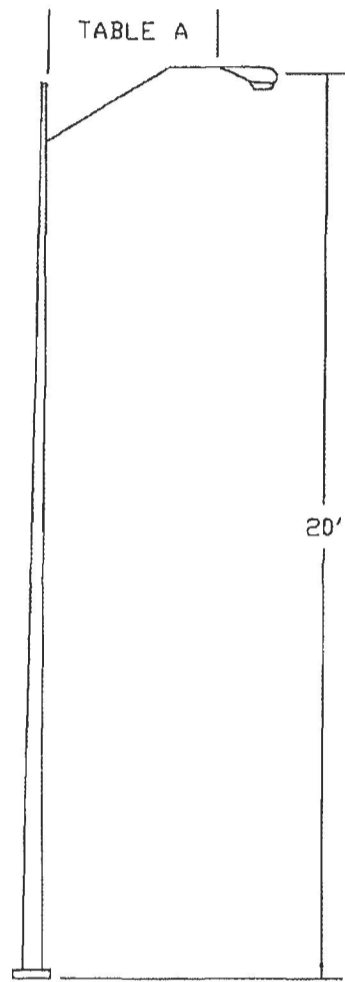

NOTES:

1. UNLESS OTHERWISE SPECIFIED, ROUND TAPERED POLES
2. UNLESS OTHERWISE SPECIFIED, STANDARD GALVANIZED POLES OR PAINT IN LIEU OF GALVANIZATION
3. USE STANDARD NUT COVERS OR BASE COVERS
4. USE UPSWEEP STYLE MAST ARMS
5. LIGHT EMISSIONS MUST DIRECT DOWNWARD
6. CUT-OFF STYLE LENSES
7. DESIGN FOR 90 MPH WIND SPEED + GUST FACTOR

LUMINAIRE ARM DESIGN TABLE

ARM LENGTH	DEAD LOAD DEFLECTION	BOLT CIRCLE DIA.	APPROX RISE
6'	1/2'	7"	1' 6 1/2'
8'	7/8"	7"	2' 6"
10'	1 3/8"	7"	3' 5 1/2'
12'	2"	7"	4' 5"
15'	3 1/8"	7"	5' 10"
20'	4 1/4"	8"	4' 3"

DATE : 1/10/2010	SCALE : NONE	STREET LIGHTING SINGLE	DESCHUTES COUNTY ROAD DEPARTMENT 
DRAWING NO. 1-5	APPROVED BY : G.KOLB		

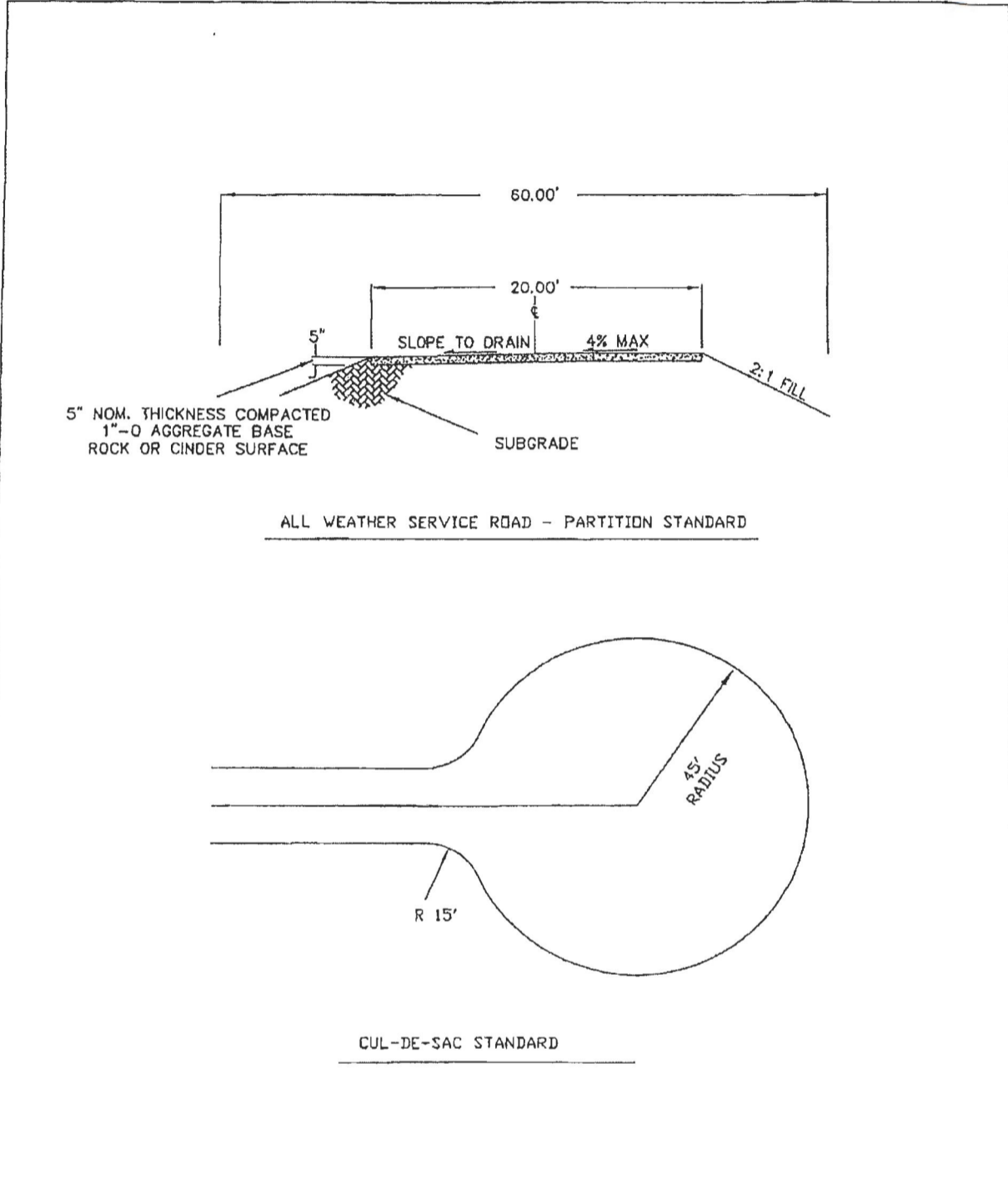

DATE :	SCALE :	ALL WEATHER SERVICE ROAD & CUL-DE-SAC STANDARD	DESCHUTES COUNTY ROAD DEPARTMENT 
1/10/2010	NONE		
DRAWING NO.	APPROVED BY :		
2-1	G.KOLB		

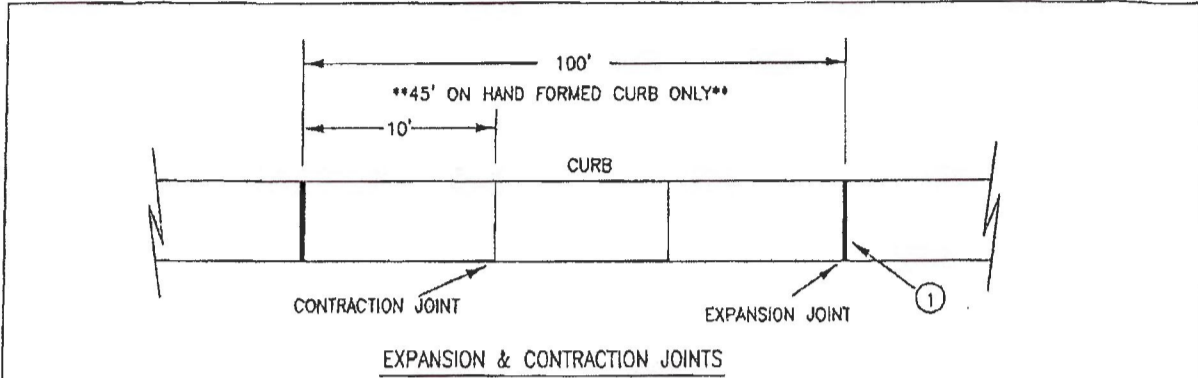

EXPANSION & CONTRACTION JOINTS

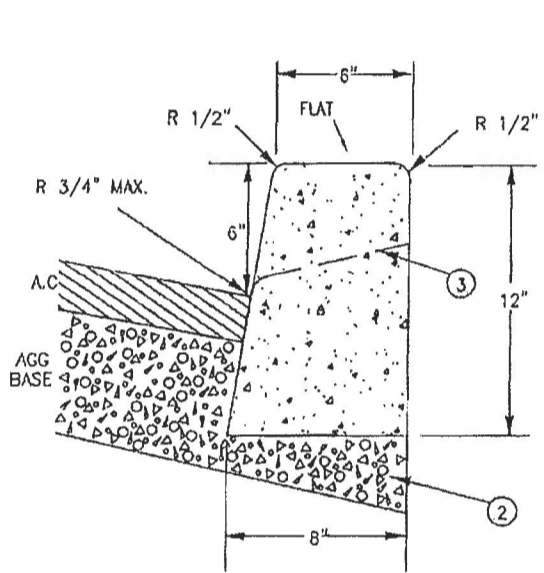

12" COUNTY STANDARD CURB

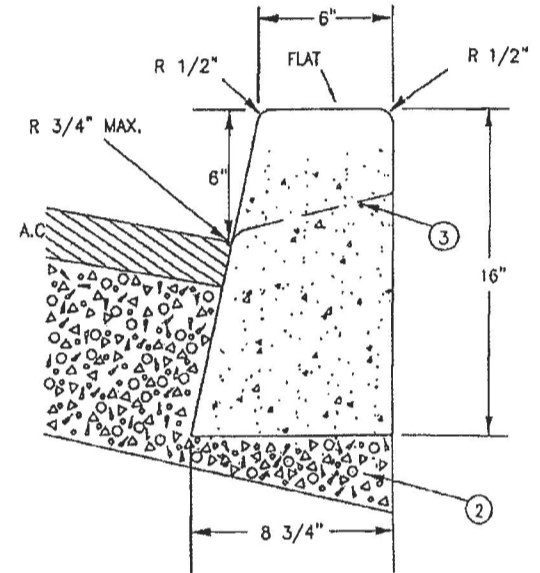

16" COUNTY STANDARD CURB

NOTES:

- CONCRETE SHALL BE COMMERCIAL GRADE, 3000 P.S.I.
 PLACED ACCORDING TO CURRENT OREGON STANDARDS AND SPECIFICATION FOR CONSTRUCTION, SECTION 00440 AND
 CONTAIN NO ADDITIVES TO CAUSE RAPID SETTING. PROTECT FROM ADVERSE WEATHER FOR 7 DAYS.
1. EXPANSION JOINTS ARE REQUIRED AT:
 - A. END OF CURB RADIUS
 - B. DRIVEWAY APRONS
 - C. POINTS OF CURVATURE
 - D. MAXIMUM SPACING OF 100' ON MACHINE FORMED CURBS
 - E. MAXIMUM SPACING OF 45' ON HAND FORMED CURBS
 2. BASE ROCK UNDER CURB AS REQUIRED TO MATCH STREET SECTION. 2" MINIMUM THICKNESS.
 3. LIGHT BROOM FINISH REQUIRED.

DATE :	SCALE :	CONCRETE CURB	DESCHUTES COUNTY ROAD DEPARTMENT	
3/14/11	NONE			
DRAWING NO.	APPROVED BY :			
2-2	G.KOLB			

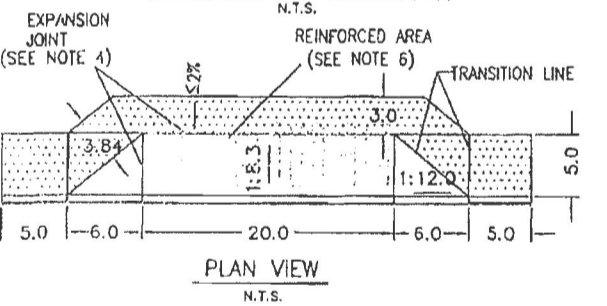
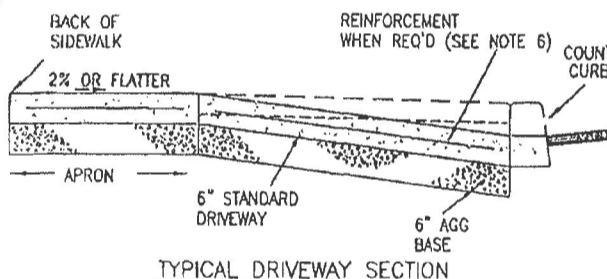
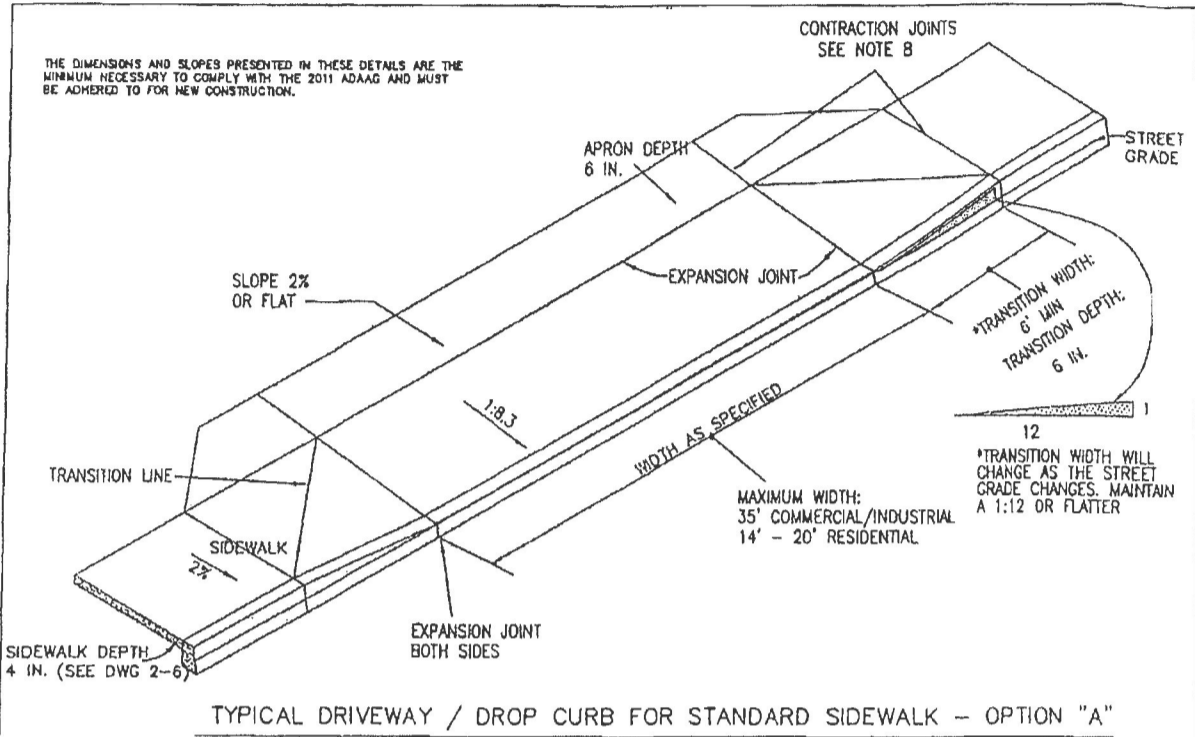

- NOTES:
1. COMPACT BACKFILL UNDER SIDEWALK & DRIVEWAY TO 95% OF RELATIVE MAXIMUM DENSITY (AASHTO T-99) TO 6" THICK MIN.
 2. CONCRETE SHALL BE COMMERCIAL GRADE, 3000 P.S.I. PLACED ACCORDING TO CURRENT OREGON STANDARDS AND SPECIFICATION FOR CONSTRUCTION, SECTION 00440, CONTAIN NO ADDITIVES TO CAUSE RAPID SETTING AND BE PROTECTED FROM ADVERSE WEATHER FOR 7 DAYS.
 3. LIGHT TRANSVERSE BROOM FINISH REQUIRED ON SIDEWALKS AND DRIVEWAYS.
 4. FULL EXPANSION JOINTS AT ENDS OF DRIVEWAY. CONTRACTION JOINTS AT TRANSITION LINES AND 5' CENTERS ALONG SIDEWALK.
 5. MAINTAIN CONSTANT GRADE AT BACK EDGE THROUGH DRIVEWAYS WHENEVER POSSIBLE.
 6. NO. 4 REBAR (2 LONGITUDINAL BARS, TRANSVERSE BARS 4'-0" O.C.) REQUIRED IN COMMERCIAL AND INDUSTRIAL DRIVEWAYS. 6"x 6", 10 GA., WIRE MESH MAY BE USED IN LIEU OF REBAR.
 7. DRIVEWAY APRONS ARE REQUIRED ON ALL NEW CONSTRUCTION.
 8. DRIVEWAYS GREATER THAN 15' WILL REQUIRE ADDITIONAL CONTRACTION JOINTS WITHIN THE DRIVEWAY AREA.

DATE :		SCALE :	CONCRETE DRIVEWAY APRON OPTION "A"	DESCHUTES COUNTY ROAD DEPARTMENT	
3/14/2011		NONE			
DRAWING NO.:		APPROVED BY :			
2-3		G.KOLB			

NOTES:

1. COMPACT BACKFILL UNDER SIDEWALK & DRIVEWAY TO 95% OF RELATIVE MAXIMUM DENSITY (AASHTO T-99) TO 6" THICK MIN.
2. CONCRETE SHALL BE COMMERCIAL GRADE, 3000 P.S.I. PLACED ACCORDING TO CURRENT OREGON STANDARDS AND SPECIFICATION FOR CONSTRUCTION, SECTION 00440, AND CONTAIN NO ADDITIVES TO CAUSE RAPID SETTING. PROTECT FROM ADVERSE WEATHER FOR 7 DAYS.
3. LIGHT TRANSVERSE BROOM FINISH REQUIRED ON SIDEWALKS AND DRIVEWAYS.
4. FULL EXPANSION JOINTS AT ENDS OF DRIVEWAY. CONTRACTION JOINTS ALONG TRANSITION LINES AND 5' CENTERS ALONG SIDEWALK.
5. MAINTAIN CONSTANT GRADE AT BACK EDGE THROUGH DRIVEWAYS WHENEVER POSSIBLE.
6. NO. 4 REBAR (2 LONGITUDINAL BARS, TRANSVERSE BARS 4'-0" O.C.) REQUIRED IN COMMERCIAL AND INDUSTRIAL DRIVEWAYS. 6"x 6", 10 GA. WIRE MESH MAY BE USED IN LIEU OF REBAR.
7. DRIVEWAY APRONS ARE REQUIRED ON ALL NEW CONSTRUCTION.
8. DRIVEWAYS GREATER THAN 15' IN WIDTH WILL REQUIRE ADDITIONAL CONTRACTION JOINTS WITHIN THE DRIVEWAY SECTION.

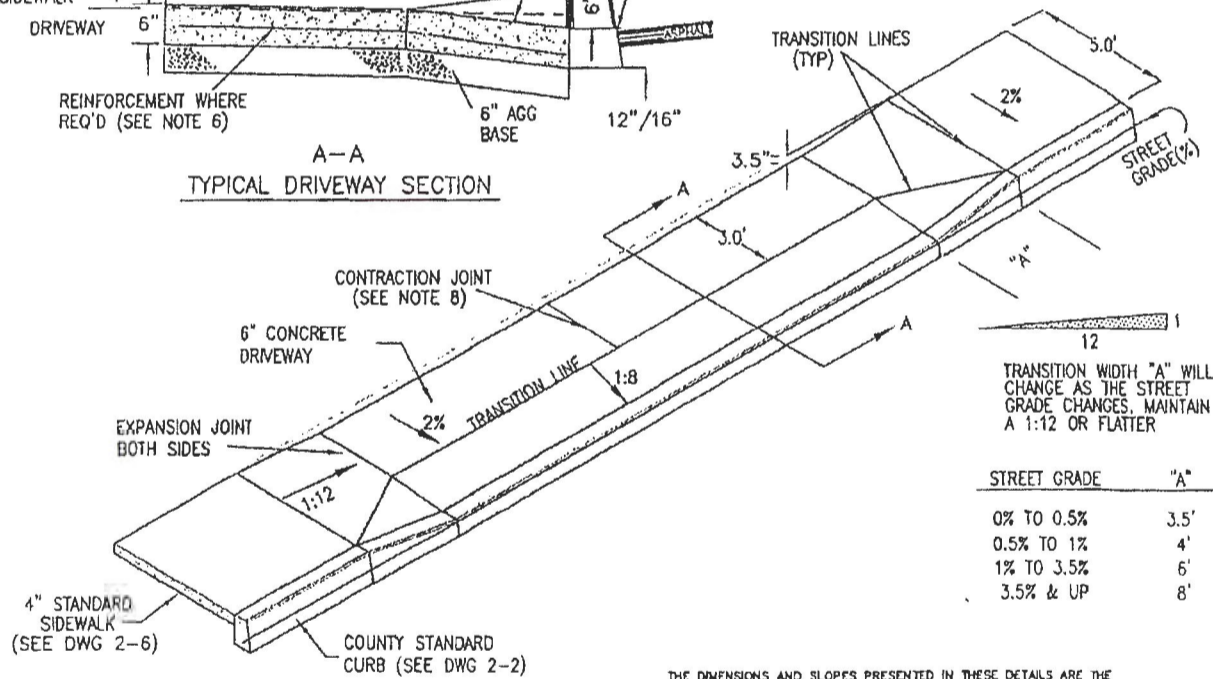
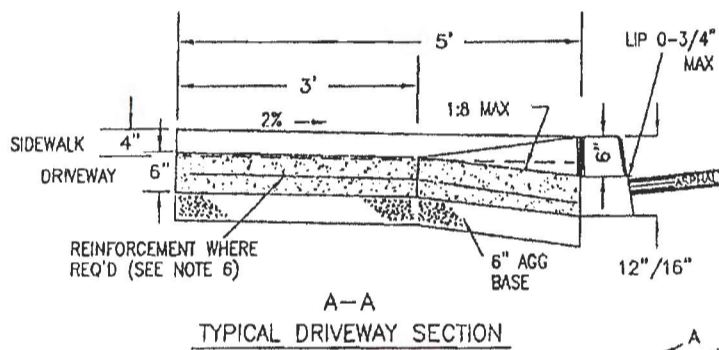
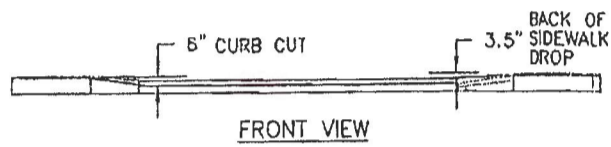
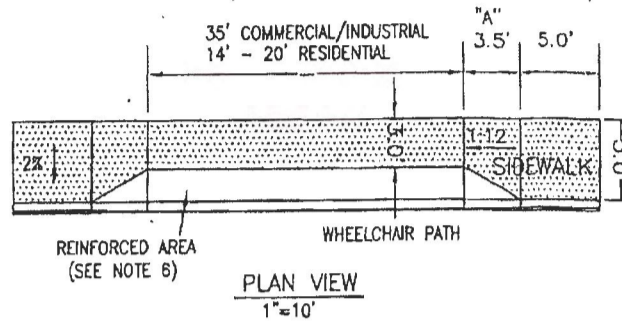

THE DIMENSIONS AND SLOPES PRESENTED IN THESE DETAILS ARE THE MINIMUM NECESSARY TO COMPLY WITH THE 2011 ADAAG AND MUST BE ADHERED TO FOR NEW CONSTRUCTION.

DATE :	SCALE :	CONCRETE DRIVEWAY APRON OPTION "B"	DESCHUTES COUNTY ROAD DEPARTMENT	
3/14/11	NONE			
DRAWING NO.	APPROVED BY :			
2-4	G.KOLB			

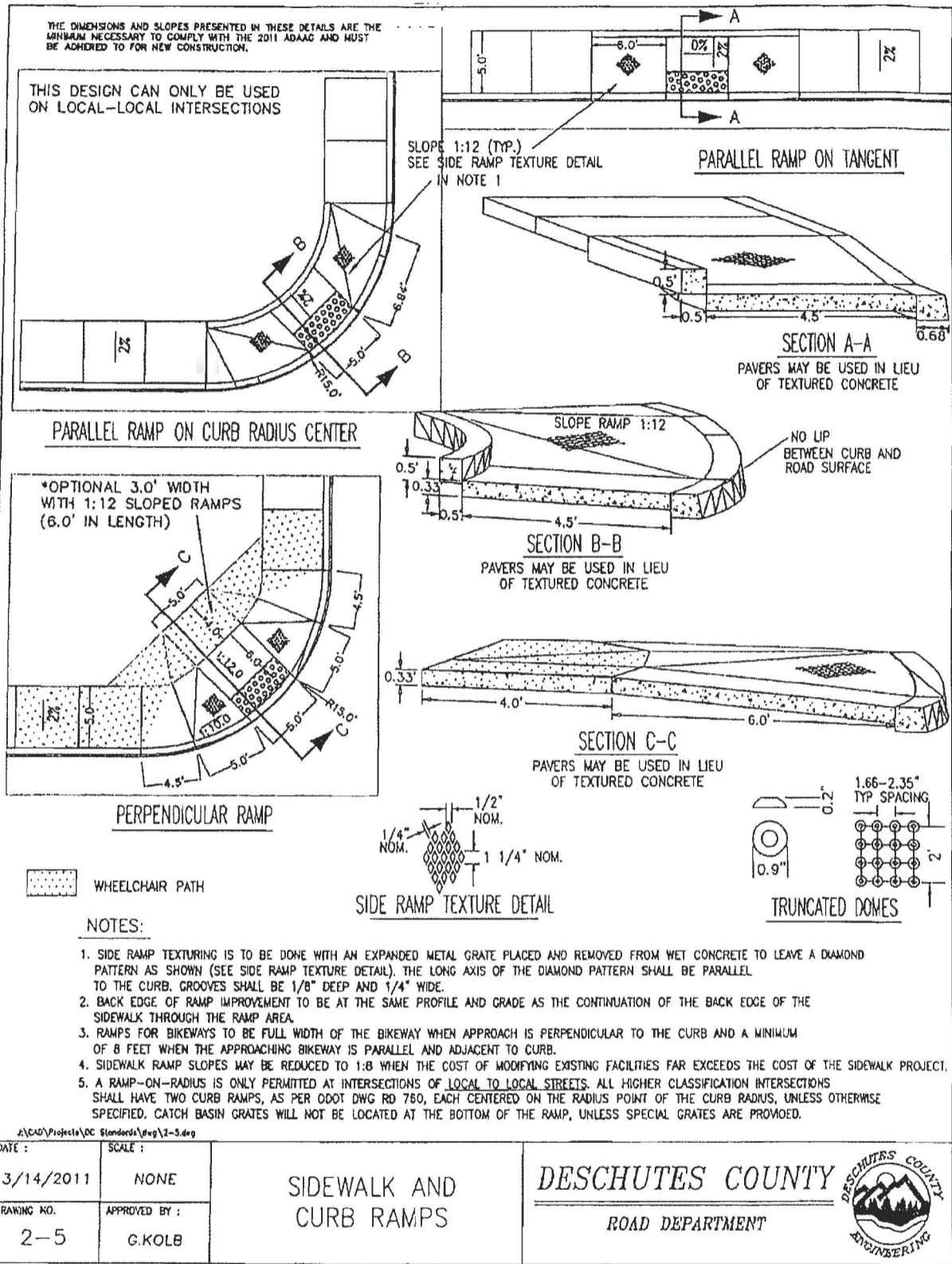

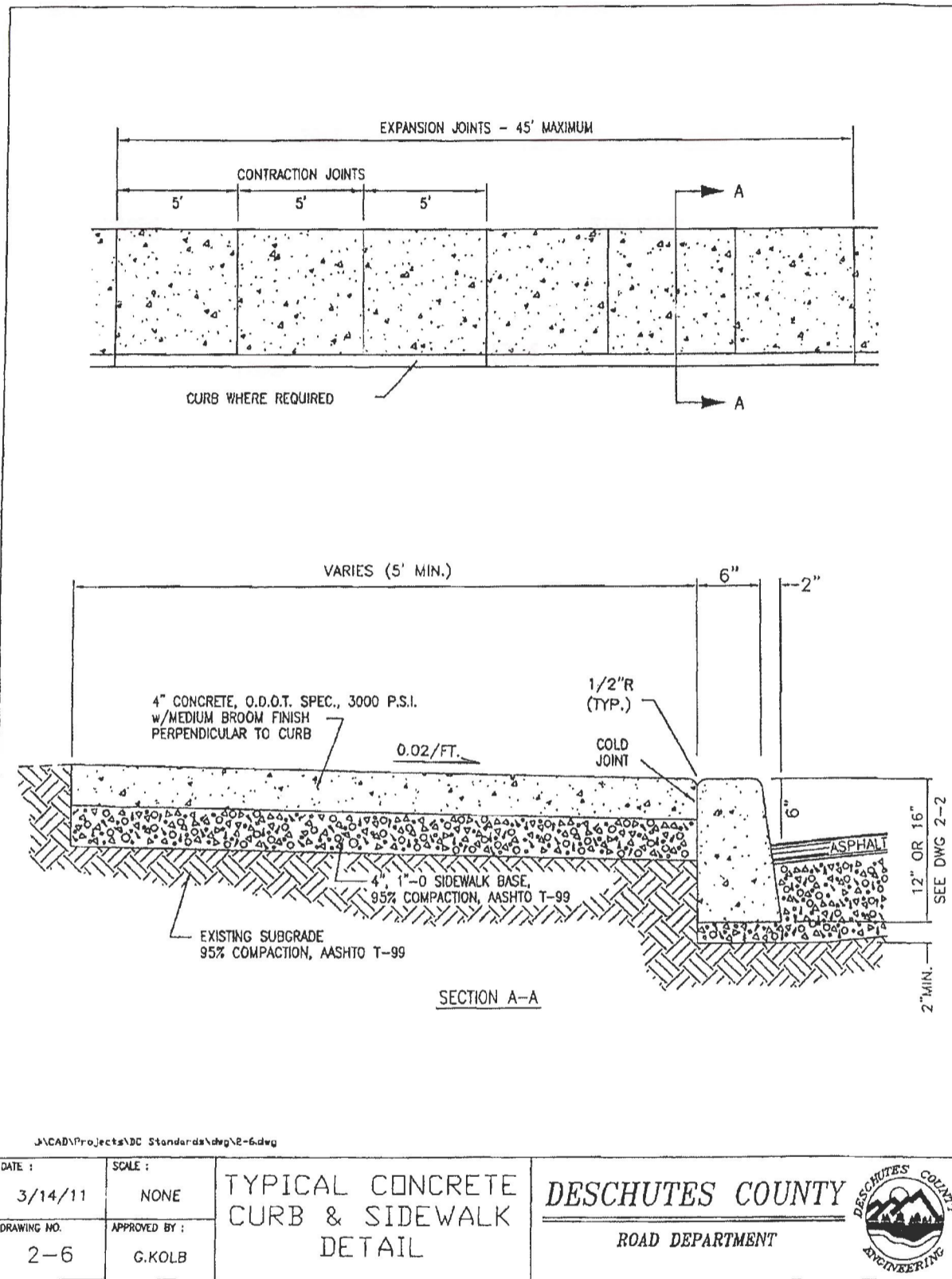

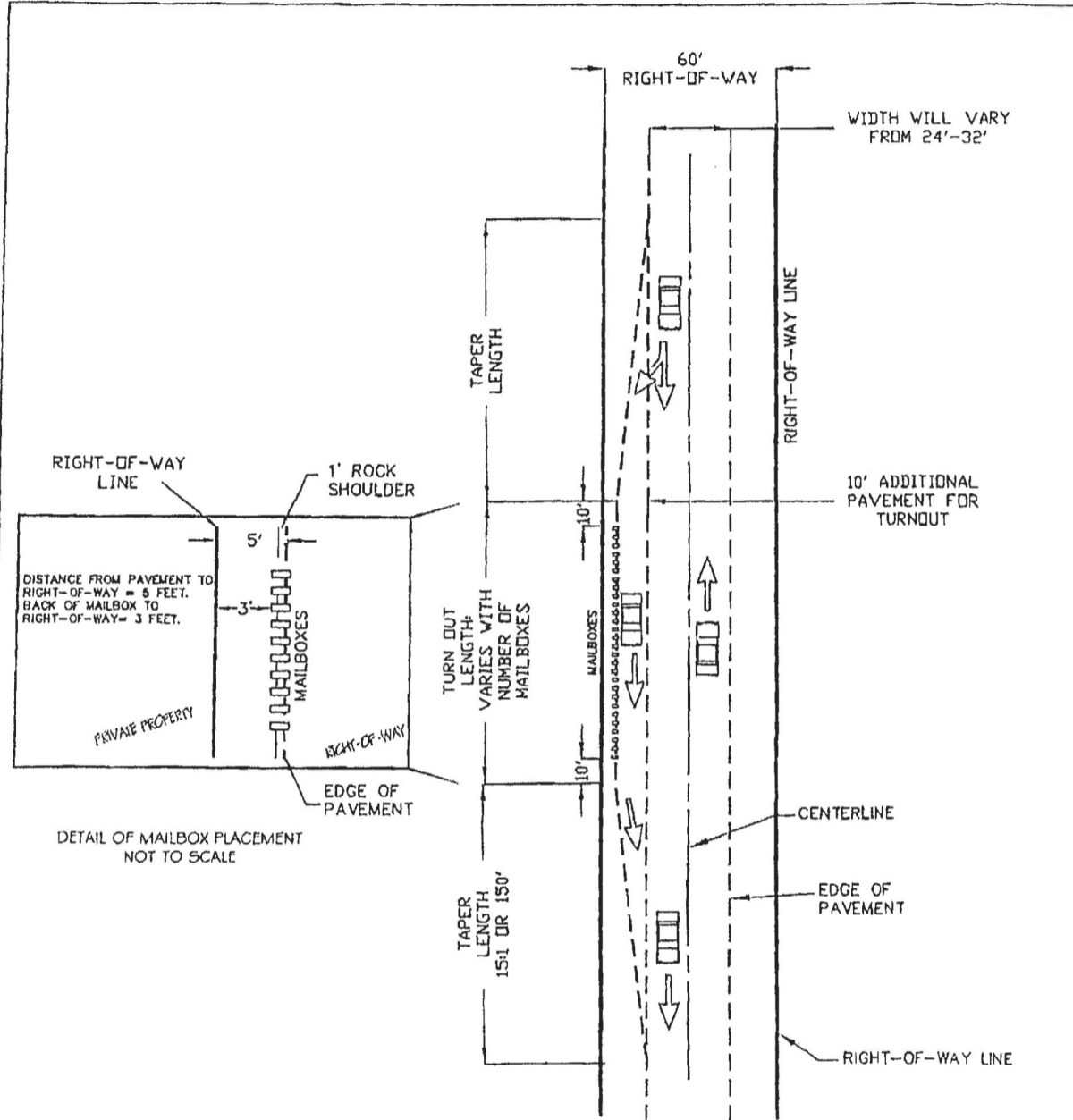

J:\CAD\Projects\DC Standards\deg\2-7.dwg

DATE :	SCALE :	CLUSTER POSTAL DELIVERY BOX PARKING BAY	DESCHUTES COUNTY ROAD DEPARTMENT	
3/14/11	NONE			
DRAWING NO.	APPROVED BY :			
2-7	G.KOLB			

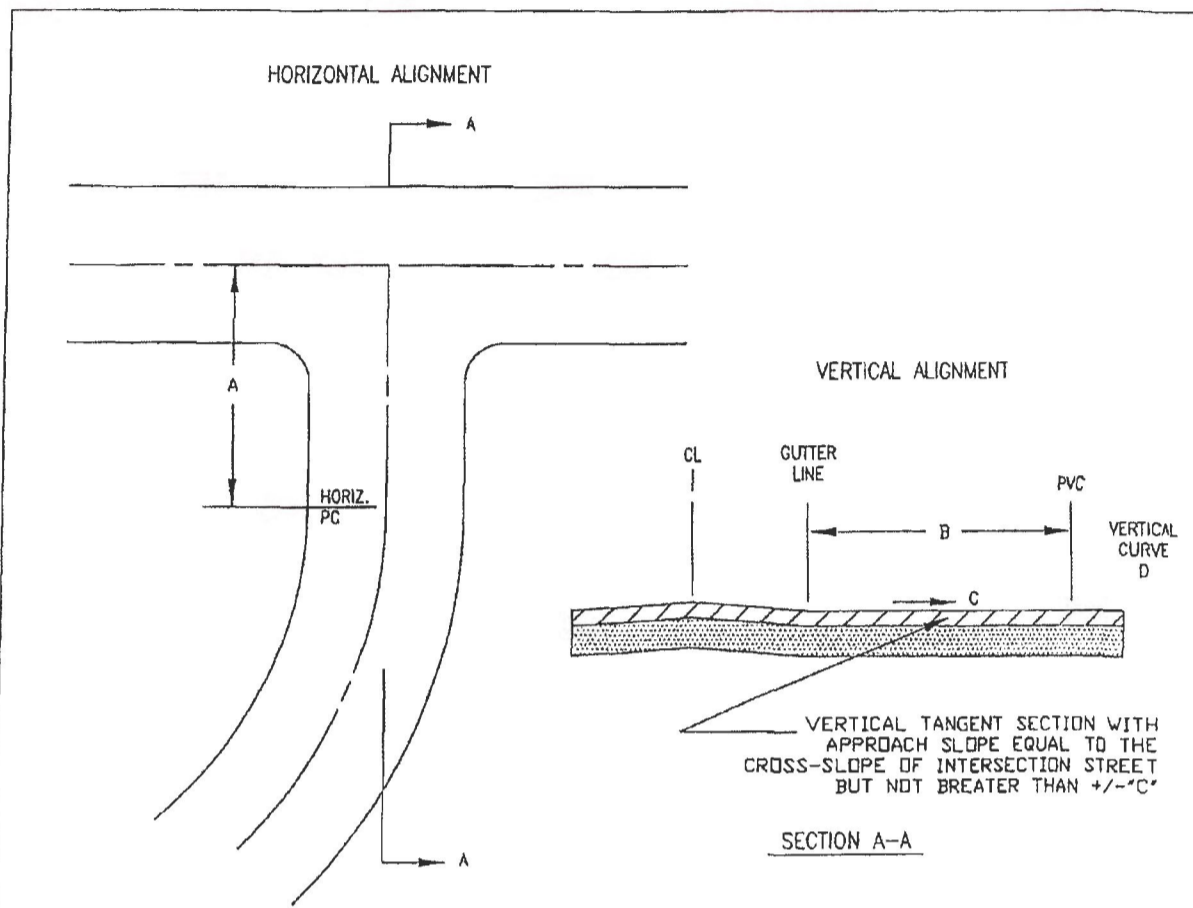

THRU STREET	STEM STREET	A MIN	B MIN	C MAX SLOPE	D MIN V.C.
LOCAL/INDUSTRIAL	LOCAL/INDUSTRIAL	0'	0'	6%	50'
COLLECTOR	LOCAL/INDUSTRIAL	50'	50'	4%	50'
COLLECTOR	COLLECTOR	100'	100'	3%	100'
ARTERIAL	LOCAL	50'	50'	4%	100'
ARTERIAL	COLLECTOR	100'	100'	2%	125'
ARTERIAL	ARTERIAL	200'	200'	2%	150'

DATE : 1/10/2010	SCALE : NONE	"T" INTERSECTION ALIGNMENT STANDARD	DESCHUTES COUNTY ROAD DEPARTMENT	
DRAWING NO. 2-8	APPROVED BY : C.KOLB			

TYPE		0-9			0-11			
APPROX. THICK		7/8"			1-1/4"			
		SIZE	RATES PER SQ.YD	QUAN. PER MILE	SIZE	RATES PER SQ.YD	QUAN. PER MILE	
SPREADS	1ST	ASPHALT	.50 GAL	29.21 TONS		.55 GAL	37.64 TONS	
		AGGREGATE	3/4"-1/2"	.016 cy	225 cy	1 1/4"-3/4"	.025 cy	352 cy
	2ND	ASPHALT	.45 GAL	26.29 TONS		.50 GAL	29.21 TONS	
		AGGREGATE	1/2"-1/4" 1/4"-#10	.008 cy .003 cy	141 cy 42 cy	3/4"-1/2" 1/2"-1/4"	.016 cy .003 cy	223 cy 42 cy
	3RD	ASPHALT						
		AGGREGATE						
	SEAL	EMULS. ASPHALT		.40 GAL	23.36 TONS		.40 GAL	23.36 TONS
		AGGREGATE	1/4"-#10	.009 cy	127 cy	1/4"-#10	.009 cy	127 cy

	ASPHALT		EMULSIFIED ASPHALT	
	AC-20	AC15-5TR	CRS-2 CRS-2P	HFRS-P1
TONS OF ASPHALT				
GALS/TON AT 60 DEG. F	235	238	241	241
NORMAL APPLICATION TEMPERATURE	300	300	155	150
GALS/TON AT NORMAL APPLIC. TEMP	258	259	244	246

DATE :	SCALE :	ASPHALT PENETRATION MACADAM (OILMAT) SPECIFICATIONS	DESCHUTES COUNTY ROAD DEPARTMENT	
1/10/2010	NONE			
DRAWING NO.	APPROVED BY			
2-9	G.KOLB			

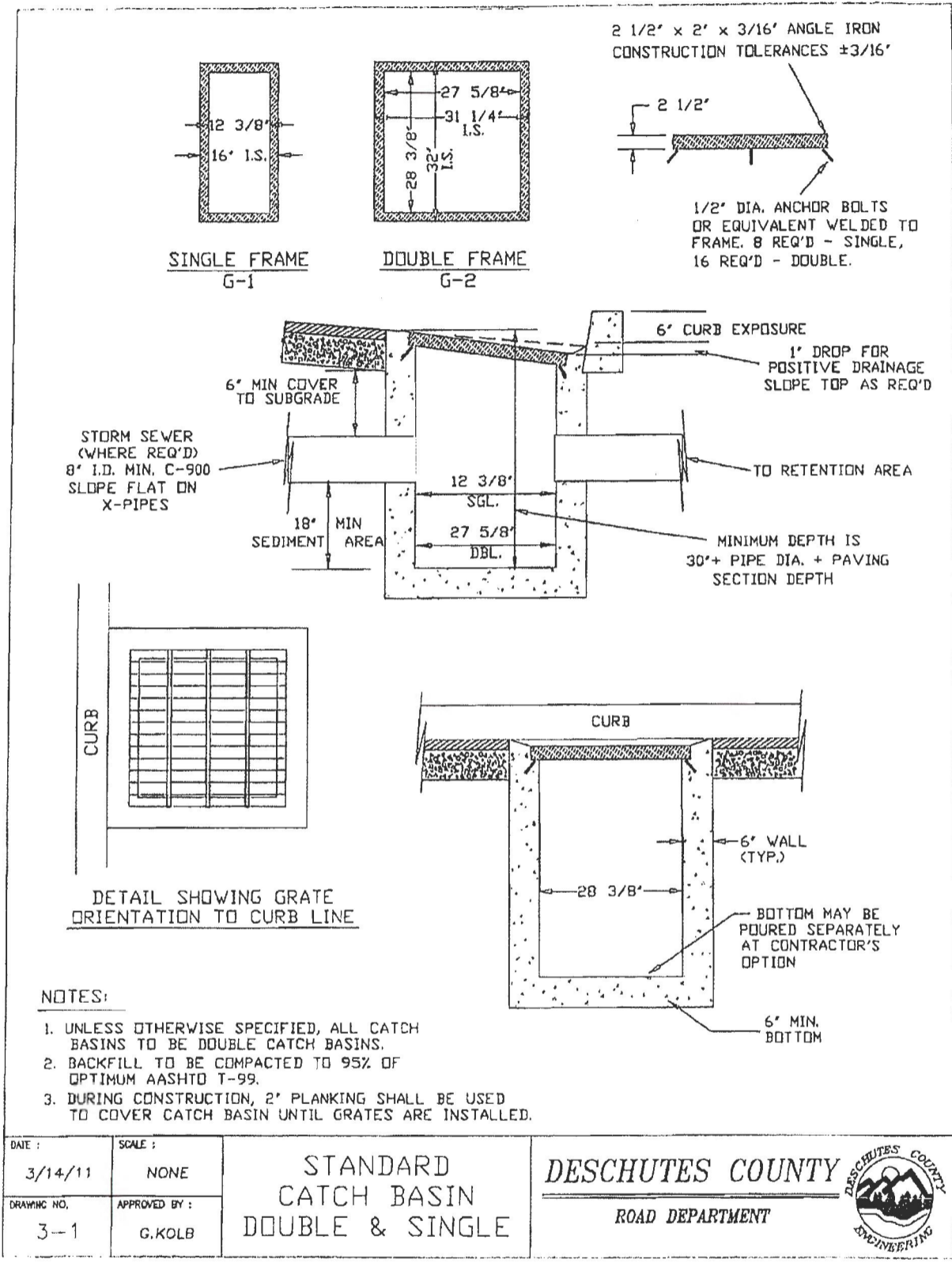

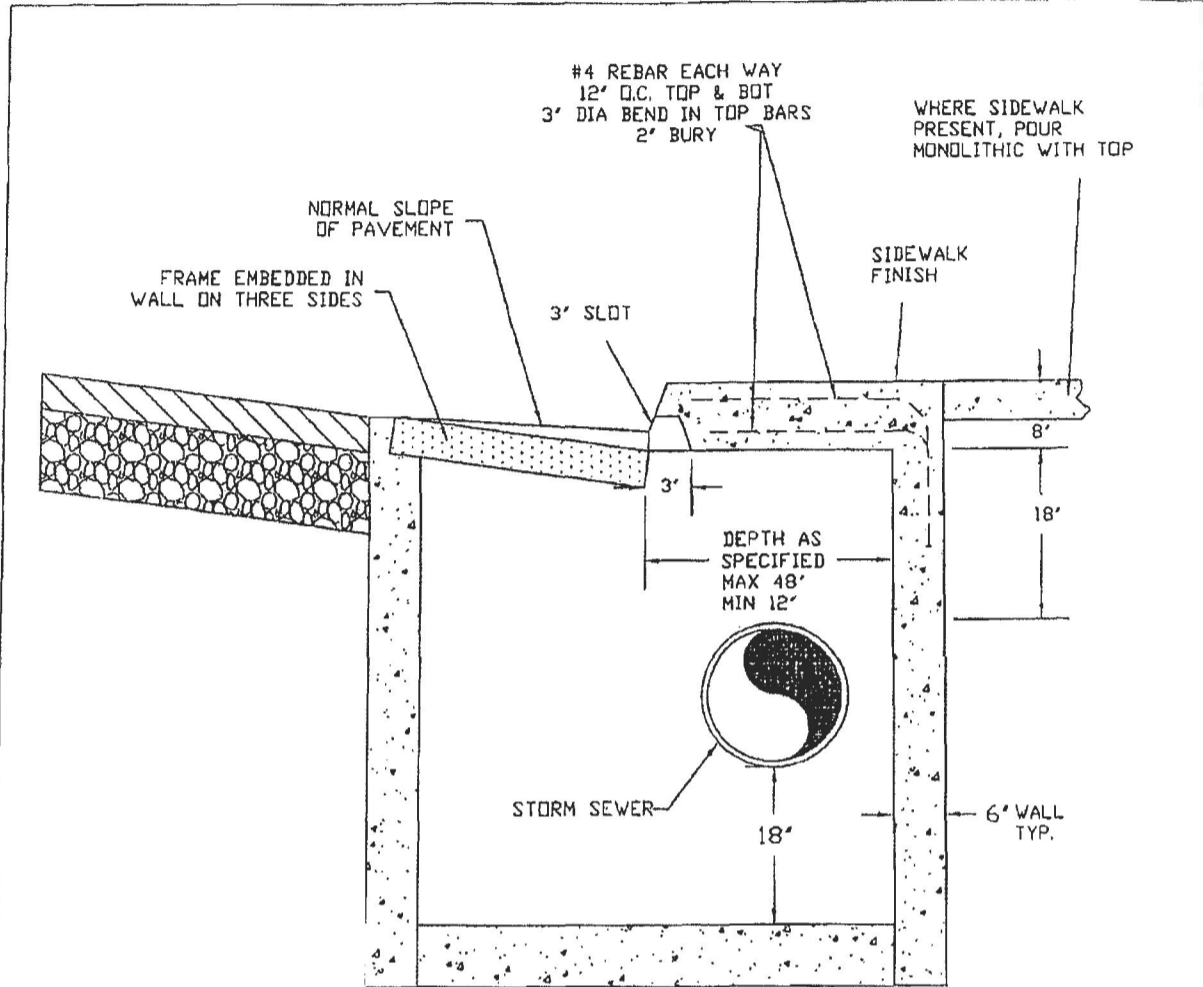

NOTES:

- SEE DWG. 3-3 FOR GRATE DETAILS
- TYPE CG-1 SINGLE CATCH BASIN FRAME
- TYPE CG-2 DOUBLE CATCH BASIN FRAME

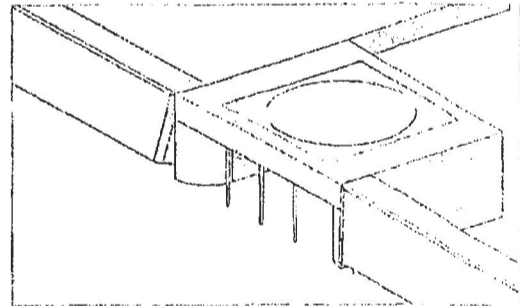

TYPE CG-3

CONCRETE INLETS ARE ALLOWED. SEE D.I.D.T. DWG RD372 FOR DETAILS

DATE :	SCALE :	SIDEWALK CATCH BASIN	DESCHUTES COUNTY ROAD DEPARTMENT	
3/14/11	NONE			
DRAWING NO.	APPROVED BY :			
3-2	G.KOLB			

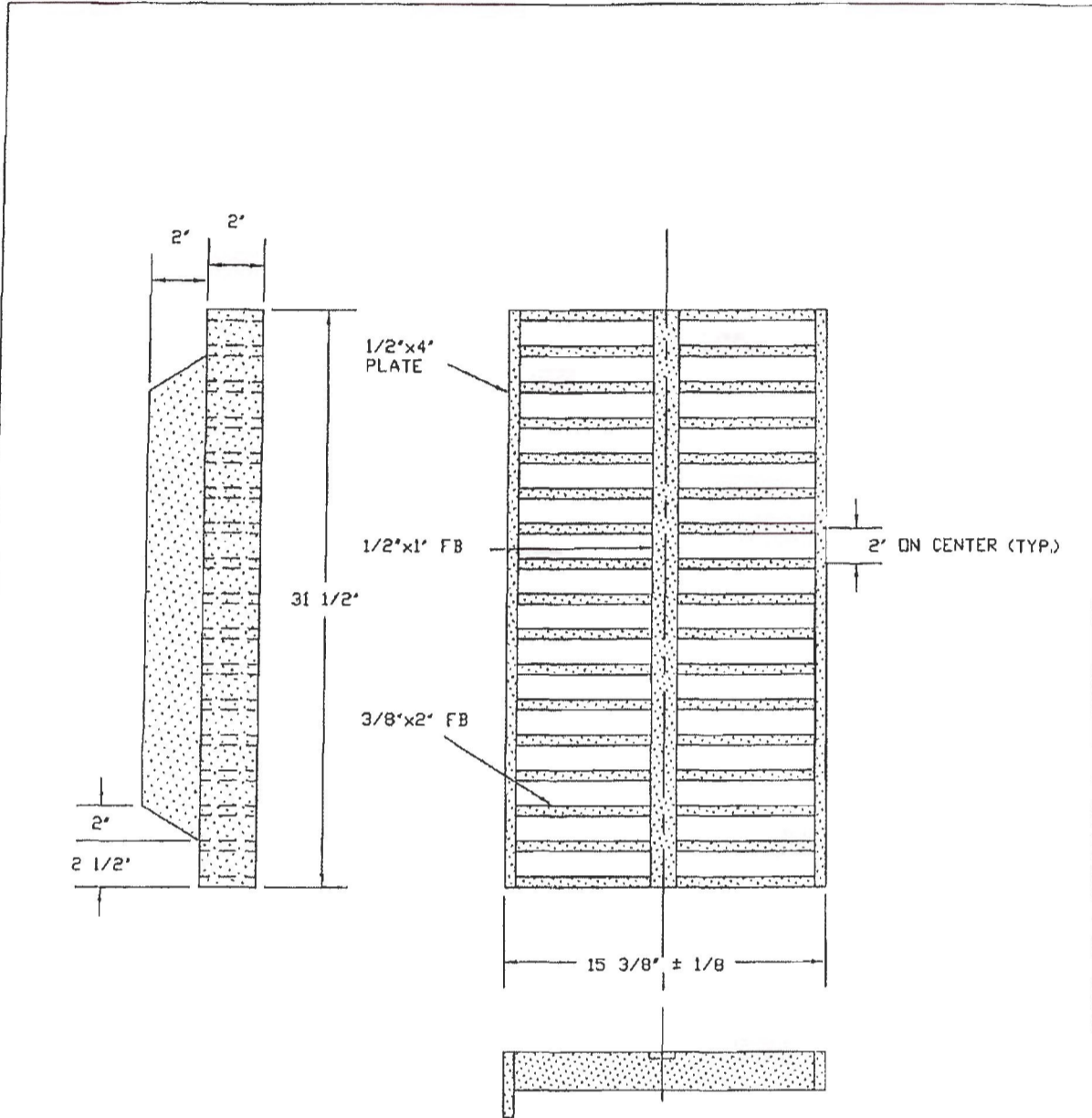

NOTES:

4" DEPTH BAR AS SHOWN FOR DOUBLE CATCH BASIN ONLY. 2" DEPTH ALL AROUND FOR SINGLE CATCH BASIN, DELETE FLANGE.

DATE :	SCALE :	STANDARD CATCH BASIN GRATE	DESCHUTES COUNTY ROAD DEPARTMENT	
1/10/2010	NONE			
DRAWING NO.	APPROVED BY :			
3-3	G.KOLB			

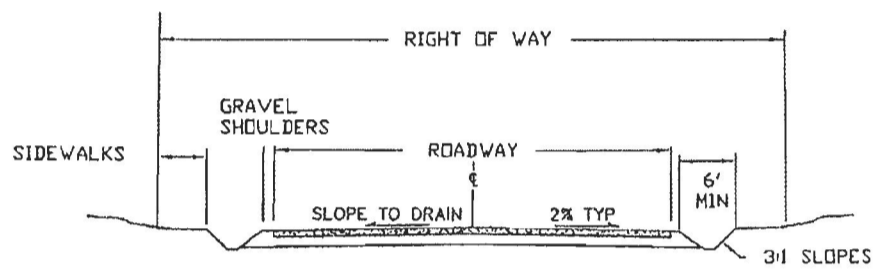

LOCAL ROAD WITH SWALES AND SIDEWALKS

NOTES:

SEE DCC17-TABLE 'A' FOR MINIMUM ROAD DESIGN STANDARDS'
 SWALES MUST COMPLY WITH CENTRAL OREGON STORMWATER MANUAL.

DATE :	SCALE :	DRAINAGE SWALE	DESCHUTES COUNTY ROAD DEPARTMENT 
1/10/2010	NONE		
DRAWING NO.	APPROVED BY :		
3-4	G.KOLB		

FINDINGS

INTRODUCTION

Title 17 – Subdivisions, deals with development that occurs within the public right-of-way throughout Deschutes County. This Title was originally adopted by the Board of County Commissioners via Ordinance No. 81-043 in December of 1981. Since that time, there have been several Ordinances (88-015; 93-012) that amended and added Chapters to the Title and other Ordinances (90-003; 93-057; 95-082; 96-003; 97-005; 97-035; 98-004; 2001-016; 2001-041 and 2004-025) that made corrections to certain Chapters. The last change to this Title was in 2004 and since that time, the Road Department has changed the standards and specifications used on products, DEQ has changed how they are handling the issue of Underground Injection Wells (UIC) and there have been major changes to the requirements for ADA access on sidewalk ramps.

DISCUSSION

There are basically two main changes that will occur as a result of this Ordinance

1. DCC 17.48 is revised to reference the Central Oregon Stormwater Manual versus the Oregon Department of Transportation Hydraulics Manual. The Central Oregon Stormwater Manual was developed in conjunction with the Cities of Bend, Redmond, Madras, Prineville and Sisters; Crook County and Deschutes County, the Oregon Association of Clean Water Agencies and the Central Oregon Community Investment Board. The committee worked with the Department of Environmental Quality (DEQ) during the process to insure that this manual was acceptable to the DEQ for stormwater related issues in development.
2. Repealed the existing standard drawings along with the existing bicycle information from the ODOT Bicycle and Pedestrian Plan. The standard drawings were last updated in 2000 and since then the County has eliminated drywells from use in the public right-of-way and adopted drainage swales for drainage. The new drawing also depicts the current standards required for ADA accessibility on sidewalk ramps. The bicycle standards were removed as they are available on the current ODOT Bicycle and Pedestrian Plan on-line on ODOT's website.

Please reference Exhibit "1" attached to these Findings, which is a detailed summary of the changes in Ordinance 2011-018. As described below, the changes in the text of Deschutes County Code Chapter 17.48 are extremely minor as are the changes in the drawings for road design and, therefore, do not involve any of the Statewide Planning Goals and are compliant with the County's Comprehensive Plan.

Exhibit "I"
Summary of Changes - Title 17

DCC 17.48:

1. 7.48.090 Intersections (A): added "per current AASHTO standards" – This is a minor change to clarify the standards. AASHTO standards are the standards accepted in the industry.
 2. 17.48.190 Drainage (A): Replaced "Oregon Department of Transportation hydraulics manual" with "Central Oregon Stormwater Manual". This is a minor change because the Central Oregon Stormwater Manual is tailored for Central Oregon.
 3. 17.48.190 Drainage (B) (2): Revised drawing numbers to match new standard drawings. This is merely housekeeping.
 4. 17.48.190 Drainage (D): Replaced "Oregon Department of Transportation hydraulics manual" with "Central Oregon Stormwater Manual". Same as 17.48.190
 5. 17.48.190 Drainage (G): Revised section to read that Injection Wells (drywells) are prohibited in the public right-of-way. Drywells do not protect ROWs adequately from stormwater runoff. The County requires drainage swales for stormwater runoff, which allow for better filtering through the ground of the pollutants in stormwater. Therefore, eliminating injections wells in the ROW better protects the ground water from the pollutants in stormwater.
 6. 17.48.220 Driveways (C): Replaced "on roadway" with "onto the public right-of way". This is merely clarifies that all of the public ROW is of concern and not merely the roadway portion of the ROW.
 7. 17.48.240 Utilities-Permit (A)(4.): Deleted the last sentence concerning the improvement agreement. The reason for eliminating that sentence is that we do not do improvement agreements for utility installation. If the contractor is not licensed, bonded and insured, we require a cash deposit for the amount stated in the permit. The permit is signed by both the County and the applicant.
- 17.48.250 Utilities - Construction-Performance Standards (A): Deleted reference to APW A and substituted "Deschutes County Standards, Title 17 and the current ODOT/APWA Oregon Standard Specifications for Construction." and updated standard drawing numbers.

8. 17.48.250 Utilities - Construction-Performance Standards (B): Revised working hours to match what is on our utility permit. This is a minor change that merely adds one hour to the morning and evening hours of worked allowed to be performed. These are still normal working hours and nothing in the Statewide goals or County Comprehensive Plan speaks to work hours.
9. 17.48.260 Utilities-Construction-Excavation (C): Changed distance from 250 to 300 feet. This is a minor change in that trenches along roads will be incrementally opened eventually. This just allows a longer trench at any given time.
10. 17.48.270 Utilities-Construction-Backfilling and Restoring (B): Revised standard drawing number. This is merely housekeeping.
11. 17.48.330 Construction-General Specifications: Changed reference on applicable specifications on contracts to "current edition of the ODOT/APWA Oregon Standard Specifications for Construction".
12. 17.48.340 Construction-Testing: Updated references to "Current Addition" versus stating a year. Changing years of publications does not involve the statewide planning goals or the County's Comprehensive Plan.
13. 17.48.390 to 17.48.440: Added reference to current ODOT/APWA Oregon Standard Specifications for Construction.
14. 17.48.420 Construction-Surfacing Requirements (3): Deleted paragraph. What type of materials are allowed for constructing a road or a sidewalk is not relevant to the statewide planning goals or the County's Comprehensive Plan because it does not affect the location or amount of ROW needed for any given project. This section references the use of three inch minus cinder aggregate which we do not use anymore
15. 17.48.420 Construction-Surfacing Requirements (D): Replaced "Class C" with "Level 3 HMA". This is a new designation of HMA used in the ODOT/APWA Oregon Standard Specifications for Construction
16. 17.48.430 Construction-Concrete Curb: Changed class of concrete from Class 3300 to 3000 to match ODOT/APWA Oregon Standard Specifications for Construction
17. 17.48.440 Construction-Sidewalks: Changed class of concrete from Class 3300 to 3000 to match ODOT/APWA Oregon Standard Specifications for Construction
18. 17.48.460 Construction-Sidewalks: Changed class of concrete from Class 3300 to 3000 to match ODOT/APWA Oregon Standard Specifications for Construction

19. 17.48.470 Construction-Permanent Traffic Control: Deleted the first sentence referencing Appendix B and added statement at the end of the section concerning the Current Federal Highway Administrations Manual on Uniform Traffic Control Devices (MUTCD). The MUTCD provides a uniform sign standard used throughout the state and is updated from time to time. Thus, it is more current than the existing Appendix B to this chapter to better deal with current technology. The goals and comprehensive plan are not implicated by this change because these regulations are for safety and, possibly, aesthetics but the goals and the comprehensive plan do not have provisions for aesthetics other than in the Landscape Management areas and those are governed by DCC Chapter 18.84 that has its own more specific sign regulations.

Drawings, Standard Drawings

1. Repealed the existing standard drawings along with the existing bicycle information from the ODOT Bicycle and Pedestrian and replaced it with revised standard drawings. Drawings changed are as follows:
 - a. 1-3: Revised backfill note to show Class "B" or "C" backfill can be used from top to trench to top of pipe.
 - b. 1-4: New drawing, "Utility Trench in Pavement Less than 5 Yrs. Old". This is for situations where the utility cannot be installed by boring and jacking under the new pavement.
 - c. 1-5: New drawing, "Street Lighting, Single".
 - d. 2-2: Changed class of concrete from 3300 psi to 3000 psi
 - e. 2-3: Revised dwg. to meet current ADA standards
 - f. 2-4: Revised dwg. to meet current ADA standards
 - g. 2-5: Revised dwg. to meet current ADA standards
 - h. 2-7: Revised dimensions concerning layout
 - i. 3-1: Deleted Drywell drawing and replaced with "Standard Catch Basin, Double and Single".
 - j. 3-2: Deleted Dry well location drawing and replaced with "Sidewalk Catch Basin".
 - k. 3-3: Was "Standard Catch Basin, Double and Single", is now "Standard Catch Basin Grate".
 - l. 3-4: Was "Sidewalk Catch Basin", is now "Drainage Swale".
 - m. 3-5: drawing 3-5 is now drawing 3-3.
2. The information from the ODOT Bicycle and Pedestrian plan was removed as it is referenced in 17.48.140 and doesn't need to be included in the standard drawings.
Page 3.

CONCLUSION.

None of the text and drawing changes affect any statewide planning goals or the comprehensive plan because they do not significantly change how roads are constructed or how they are to designed to handle stormwater runoff. In fact, as stated above, these changes to provide drainage swales rather than catch basins actually improves the treatment of stormwater such that fewer pollutants will go into the groundwater. Additionally, most of the changes are safety related and any land use impacts will be mitigated at the time of an application for development. Until a specific development application is submitted, there is no way to determine any effect on surrounding land uses. Finally, some of the changes are to comply with the federal Americans with Disabilities Act and the County has no choice but to implement those.

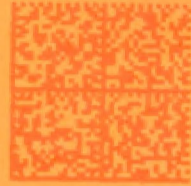

netpost®

049J82052293

\$0 1.680

11/03/2011

Mailed From 97701
US POSTAGE

Deschutes County Community Development Department

117 NW LAFAYETTE AVENUE
BEND, OREGON 97701-1925
(541) 388-6575

Plan Amendment Specialist
Dept. of Land Conserv. & Developmnt.
635 Capitol St., N.E., Suite 150
Salem, OR 97301-2540

DEPT OF

NOV 04 2011

**LAND CONSERVATION
AND DEVELOPMENT**