



Transportation **S**ystem **P**lan

Prepared by the City of Milwaukie
in association with DKS Associates

Adopted Ord. #1975 December 4, 2007
Updated Ord. # 2110 February 13, 2016

ACKNOWLEDGEMENTS

(2013 TSP Update)

Milwaukie City Council

Jeremy Ferguson, Mayor
Scott Churchill
Mark Gamba
David Hedges
Mike Miller

Milwaukie Planning Commission

Lisa Batey, Chair
Clare Fuchs, Vice Chair
Scott Barbur
Sine Bone
Shaun Lowcock
Wilda Parks
Gabe Storm

City of Milwaukie Staff

Primary Staff:

Bill Monahan, City Manager
Steve Butler, Community Development Director/
Interim Planning Director
Brett Kelper, Associate Planner
(Project Manager for 2013 TSP Update)
Jason Rice, PE, Engineering Director
Marcia Hamley, Administrative Specialist II
Jamin Kimmell, Planning Intern

Other Contributing Staff:

Brad Albert, PE, Civil Engineer
Li Alligood, Associate Planner
Katie Mangle, Planning Director*
Ryan Marquardt, Senior Planner
Alicia Martin, Administrative Specialist II
Pat Mobley, Business Analyst*
Mathangi Murthy, Planning Intern
Gary Parkin, PE, Public Works Director
Kate Rosson, GIS Coordinator
Kari Svanstrom, Associate Planner*
Grady Wheeler, Public Information Coordinator
Zach Weigel, PE, Civil Engineer*

*(*City of Milwaukie staff who were involved with the project at some point but who are no longer employed by the City as of December 2013.)*

Consultants

DKS Associates—Garth Appanaitis, PE;
Chris Maciesjewski, PE

Agency Participation

John Mermin, Metro
Gail Curtis, ODOT
Larry Conrad, Clackamas County
Steve Kautz, TriMet

Citizen Participation

The 2013 Update to the Milwaukie Transportation System Plan (TSP) was conducted with the assistance of numerous residents of Milwaukie and the larger community. Although the 2013 TSP Update did not involve a formal advisory committee or stakeholder groups, several of the various Neighborhood District Associations provided comments, and over 40 different people attended at least one of the open house events or public meetings held in April, June, and September 2013.

ACKNOWLEDGEMENTS

(2007 TSP Update)

Milwaukie City Council

Jim Bernard, Mayor
Deborah Barnes
Carlotta Colette
Joe Loomis
Susan Stone

Milwaukie Planning Commission

Jeff Klein, Chair
Dick Newman, Vice Chair
Lisa Batey
Theresa Bresaw
Scott Churchill
Charmaine Coleman
Paulette Qutub

City of Milwaukie Staff

Katie Mangle, Planning Director
Susan Shanks, Associate Planner
Mike Swanson, City Manager
Kenny Asher, Community Development and
Public Works Director
Gary Parkin, PE, Engineering Director
JoAnn Herrigel, Community Services Director
Alex Campbell, Resource and Econ. Dev. Specialist
Brett Kelver, Assistant Planner
Beth Ragel, Program Coordinator
Gavin Hales, Transportation Liaison
Ryan Marquardt, Assistant Planner
Jeanne Garst, Office Supervisor
Marcia Hamley, Admin. Specialist
Karin Gardner, Admin. Specialist
Michelle Rodriguez, Admin. Specialist
George MacGregor, PE, Civil Engineer
Brenda Schleining, Associate Engineer
Grady Wheeler, Public Information Coordinator
Sarah Lander, Code Compliance Assistant
Kate Rosson, GIS Coordinator

Consultants

DKS Associates: Carl Springer, PE; Alan Snook;
Michael Thomasini
Jeanne Lawson and Associates: Jamie Damon
BPM Development: Rick Williams
Winterbrook Planning
Alta Planning + Design: Rory Renfro

Agency Participation

Gail Curtis and Andrew Johnson, ODOT
Stacey Humphrey and Bill Holmstrom, DLCD
Shari Gilevich, Clackamas County
John Mermin, Metro
Young Park, TriMet
Phil Selinger, TriMet
Ron Schumacher and Mace Childs, North Clackamas
Fire District
Kelly Carlisle, North Clackamas Schools
Marty Hanley, Milwaukie Center

Citizen Participants

The Milwaukie Transportation System Plan was developed with the valuable assistance of the following people:

George Anderson	Nick Dougher	Steven Kung	Dick Samuels
Heather Andrews	Sherri Dow	Bill Lake	Joe Sandfort
Lorenzo Araque	Phil Favorite	Tom MacFarlane	Leslie Schockner
Melissa Arne	Parker Fitzpatrick	Dolly Macken-Hambright	Todd Schwartz
David Aschenbrenner	Steve Flury	Sarah Maier	Pam Shea
Cheryl Ausmann-Moreno	Forris Frick	Matt Menely	Dion Shepard
Jean Baker	Mark Gamba	Gary Michael	Charlie Stephens
Charles Bishop	Emily Gardner	Todd E. Mobley	Jon Stoll
Jerry Bitz	Alicia Hamilton	Renee Moog	Ron Swanson
Ray Bryan	Neil Hankerson	Bernadine Moore	Paul Sylvester
Sandi Burns	Brian Heiberg	Tim Morris	Aaron Tarfman
Kathy Buss	Greg Hemer	Keith Neubauer	Dottie Teeple
Greg Chaimov	Lee Holzman	Cara Nolam	Marge Tipton
Jill Chapman	Ben Horner-Johnson	Anne Nottingham	Cami Waner
Libby Clark-Agosti	Willi Horner-Johnson	Connie Ottoboni	Mike Wells
John Climaldi	Gary Hunt	Susanna Pai	Ann Wilson
Tim Clouse	Lynda Hunter	Virginia Pai	Julie Wisner
Lanice Coleman	Christopher Hunterman	Ed Parecki	Nancy Wittig
Bruce Conachan	Jason Jenkins	Ray Peck	Ed Zumwalt
Noah Cowgill	Michole Jensen	Matt Picio	
Debbie Cronk	Tom Kemper	Zach Rogers	
David DeVore	Paul Klein	Pat Russel	

This project is partially funded by a grant from the Transportation and Growth Management (TGM) Program, a joint program of the Oregon Department of Transportation and the Oregon Department of Land Conservation and Development. This TGM grant is financed, in part, by federal Safe, Accountable, Flexible, Efficient Transportation Equity Act: A Legacy for Users (SAFETEA-LU), local government, and State of Oregon funds.

The contents of this document do not necessarily reflect views or policies of the State of Oregon.

Milwaukie 2013 TSP

Table of Contents

Chapter 1	Executive Summary1-1	
	<i>Composite Master Plan map</i> <i>Figure 1-1</i>	
Chapter 2	Goals and Policies2-1	
Chapter 3	Existing Conditions3-1	
Chapter 4	Future Forecasting Process4-1	
Chapter 5	Pedestrian Element.....5-1	
	<i>Pedestrian Master Plan map</i> <i>Figure 5-1a</i>	
	<i>Pedestrian Action Plan</i> <i>Table 5-3</i>	
Chapter 6	Bicycle Element6-1	
	<i>Bicycle Master Plan map</i> <i>Figure 6-8a</i>	
	<i>Bicycle Action Plan</i> <i>Table 6-3</i>	
Chapter 7	Public Transit Element7-1	
	<i>Public Transit Master Plan map</i> <i>Figure 7-3</i>	
	<i>Public Transit Action Plan</i> <i>Table 7-2</i>	
Chapter 8	Street Network Element8-1	
	<i>Street Network Master Plan map</i> <i>Figure 8-5</i>	
	<i>Street Network Action Plan</i> <i>Table 8-11</i>	
Chapter 9	Freight Element9-1	
	<i>Freight Master Plan map</i> <i>Figure 9-1</i>	
	<i>Freight Action Plan</i> <i>Table 9-2</i>	
Chapter 10	Street Design10-1	
	<i>Street Design Cross Sections by Functional Classification</i> <i>Figure 10-1</i>	
Chapter 11	Neighborhood Traffic Management.....11-1	
	<i>Neighborhood Traffic Management Process</i> <i>Figure 11-1</i>	
	<i>Neighborhood Traffic Management Action Plan</i> <i>Table 11-2</i>	
Chapter 12	Downtown Parking12-1	
	<i>Downtown Parking Master Plan Projects</i> <i>Table 12-2</i>	
	<i>Downtown Parking Action Plan</i> <i>Table 12-3</i>	
Chapter 13	Funding and Implementation Plan.....13-1	
	<i>Projected Transportation Revenue</i> <i>Table 13-1</i>	
	<i>Operations, Maintenance, and Capital Costs</i> <i>Table 13-2</i>	
	<i>Consolidated Action Plan</i> <i>Table 13-3</i>	
	<i>Prioritized Master Plan Project List</i> <i>Table 13-4</i>	
Chapter 14	Transportation Planning Rule Implementation.....14-1	

Appendices

Appendix A	Neighborhood Information	
	Purpose	A-1
	<i>Pedestrian Master Plan map</i>	<i>Figure A-1</i>
	<i>Bicycle Master Plan map</i>	<i>Figure A-2</i>
	<i>Public Transit Master Plan map</i>	<i>Figure A-3</i>
	<i>Street Network Master Plan map</i>	<i>Figure A-4</i>
	<i>Freight Master Plan map</i>	<i>Figure A-5</i>
Appendix B	Public Involvement Summary	B-1
Appendix C	Prioritized Master Plan Project List	C-1
Appendix D	Conceptual Design Options	D-1
Appendix E	Glossary of Technical Terms	E-1
Appendix F	Levels of Service (LOS) Descriptions	F-1
Appendix G	Traffic Data:	
	Peak-Hour Turn Movement and 24-Hour Tube Counts	G-2
	Existing Conditions Synchro Analysis	G-98
	Future Conditions Synchro Analysis	G-122
	Signal Warrant Worksheet	G-145
	Crash Data	G-146
	Project Cost Estimates	G-166

Complete List of Figures

Figure 1-1	Composite Master Plan map	1-6
Figure 1-2	Pedestrian Master Plan map	1-8
Figure 1-3	Bicycle Master Plan map.....	1-10
Figure 1-4	Public Transit Master Plan map	1-12
Figure 1-5	Street Network Master Plan map	1-14
Figure 1-6	Freight Master Plan map.....	1-16
Figure 3-1a	Study Area Context map.....	3-2
Figure 3-1b	Study Area map	3-3
Figure 3-2	Sidewalk Inventory map	3-5
Figure 3-3a	Existing Pedestrian & Bicycle P.M. Peak-Hour Volumes	3-7
Figure 3-3b	Existing Pedestrian & Bicycle P.M. Peak-Hour Volumes	3-8
Figure 3-4	Bicycle Facility Inventory map.....	3-10
Figure 3-5	Transit Routes and Shelters map.....	3-14
Figure 3-6	Functionality of Access versus Movement	3-17
Figure 3-7	Functional Classification map.....	3-19
Figure 3-8	Roadway Jurisdiction map	3-22
Figure 3-9	Posted Speed Inventory map.....	3-23
Figure 3-10	Intersection Controls map	3-24
Figure 3-11	Stormwater and Topography map.....	3-25
Figure 3-12	Location of Street Surface Maintenance Program (SSMP) Projects map	3-27
Figure 3-13a	24-Hour Tube Count Data on SE McLoughlin Blvd and Hwy 224.....	3-29
Figure 3-13b	24-Hour Count Volumes.....	3-30
Figure 3-13c	24-Hour Count Volumes: Historic Comparison.....	3-31
Figure 3-14a	Existing P.M. Peak-Hour Traffic Volumes	3-32
Figure 3-14b	Existing P.M. Peak-Hour Traffic Volumes	3-33
Figure 3-15	Zoning Map.....	3-35
Figure 3-16	Truck Routes map.....	3-39
Figure 3-17	Rail Routes & Crossings map	3-42
Figure 3-18	Downtown Parking map	3-44
Figure 3-19	Transit Disadvantaged map	3-49
Figure 3-20	Wetlands, Flood & Cultural Features map.....	3-51
Figure 3-21	Environmental Resources—Goal 5 map	3-52
Figure 3-22	Environmental Resources—Zoning & Vegetation map.....	3-53
Figure 4-1	Transportation Analysis Zones map.....	4-3
Figure 4-2	Travel Forecasting Model Process.....	4-5
Figure 4-3	2035 Beta Model Financially Constrained Non-SOV Percentage map	4-9

Figure 5-1a	Pedestrian Master Plan map	5-5
Figure 5-1b	Pedestrian Master Plan Downtown Inset map	5-6
Figure 6-1	Multiuse Path	6-4
Figure 6-2	Cycle Track.....	6-4
Figure 6-3	Bike Lane.....	6-5
Figure 6-4	Shared Roadway	6-5
Figure 6-5	Bicycle Signs and Markings	6-6
Figure 6-6	Neighborhood Greenway	6-6
Figure 6-7	Sample Traffic Calming Measures	6-7
Figure 6-8a	Bicycle Master Plan map.....	6-11
Figure 6-8b	Bicycle Master Plan Downtown Inset map	6-12
Figure 7-1	Peak-Hour Transit Coverage map.....	7-4
Figure 7-2	Off-Peak Transit Coverage map.....	7-5
Figure 7-3	Public Transit Master Plan map	7-12
Figure 8-1	Functional Classification map.....	8-3
Figure 8-2a	Percent Increase in P.M. Peak-Hour Volumes	8-7
Figure 8-2b	2035 P.M. Peak-Hour Volume/Capacity for Major Roads.....	8-9
Figure 8-3	2035 Future No-Build Operations Study Area Intersections	8-13
Figure 8-4	Proposed Street Connectivity Plan map.....	8-19
Figure 8-5	Street Network Master Plan map	8-29
Figure 9-1	Freight Master Plan map.....	9-6
Figure 10-1	Street Design Cross Sections by Functional Classification.....	10-6
Figure 10-2	Skinny Street Design Options	10-10
Figure 11-1	Neighborhood Traffic Management Process	11-12
Figure 12-1	Diagram of Parking Type Locations	12-9
Figure 13-1	Projected Transportation Revenue for the 22-Year Planning Period (in 2012 dollars).....	13-5
Figure 13-2	Projected Transportation Costs for the 22-Year Planning Period (in 2012 dollars).....	13-7
Figure 13-3	Spending Scenario 1: Funding Limited to Capital-Restricted Revenue over the 22-Year Planning Period (in 2012 dollars)	13-8
Figure 13-4	Spending Scenario 2: Funding All Capital Projects on Consolidated Action Plan over the 22-Year Planning Period (in 2012 dollars)	13-8

Complete List of Tables

Table 2-1	2040 Regional Metro Targets for Non-Single-Occupant Vehicles (non-SOVs) ..2-3
Table 3-1	Service Route Schedules and Destinations.....3-12
Table 3-2	Neighborhood Service Routes and Transit Amenities3-13
Table 3-3	TriMet Service Routes and Weekday Peak Period Level of Service.....3-15
Table 3-4	Functional Classification Comparison Arterial and Collector Streets3-20
Table 3-5	Average Pavement Condition Index.....3-26
Table 3-6	Pavement Condition Index Rating by Functional Classification3-26
Table 3-7	Existing P.M. Peak-Hour Study Area Intersection Operations3-36
Table 3-8	SPIS Rating of Milwaukie TSP Update Study Area Intersections3-38
Table 3-9	Inventory of Existing Downtown Parking3-43
Table 3-10	Use of Parking Spaces by Type3-45
Table 3-11	Downtown Parking Demand—Mixed Land Use to Built Supply3-46
Table 4-1	Milwaukie TSP Study Area Land Use Summary4-2
Table 4-2	Approximate Average P.M. Peak Period Trip Rates Used in Metro Model4-6
Table 4-3	Milwaukie Vehicle Trip Generation (2-Hour P.M. Peak Period)4-6
Table 4-4	Milwaukie Vehicle Trip Distribution (2-Hour P.M. Peak Period)4-7
Table 5-1	Pedestrian Master Plan Projects5-7
Table 5-2	Potential Measures for Enhancing Pedestrian Crossings5-13
Table 5-3	Pedestrian Action Plan.....5-14
Table 6-1	Bikeway Types.....6-3
Table 6-2	Bicycle Master Plan Projects.....6-13
Table 6-3	Bicycle Action Plan6-18
Table 7-1	Public Transit Master Plan Projects7-13
Table 7-2	Public Transit Action Plan7-15
Table 8-1	City of Milwaukie Functional Classifications8-4
Table 8-2	RTP Financially Constrained Motor Vehicle Capacity Improvements8-6
Table 8-3	Summary of Travel Time Reliability Measures by Corridor.....8-8
Table 8-4	2035 Base Case Intersection Level of Service (P.M. Peak Hour)8-11
Table 8-5	Summary of Motor Vehicle System Gaps and Needs.....8-14
Table 8-6	Access Spacing Standards for City Street Facilities8-17
Table 8-7	Access Spacing Standards for ODOT Facilities8-17
Table 8-8	TDM Improvements included in the RTP Financially Constrained System8-22
Table 8-9	Improvements Needed for City Intersections to Meet City Standards.....8-23
Table 8-10	Street Network Master Plan Projects.....8-30
Table 8-11	Street Network Action Plan8-33
Table 8-12	2035 Action Plan Intersection Level of Service (P.M. Peak Hour)8-34
Table 9-1	Freight Master Plan Projects9-7

Table 9-2	Freight Action Plan.....	9-8
Table 10-1	Pedestrian Facility Design Alternatives	10-7
Table 10-2	Green Street Design Treatments	10-8
Table 11-1	Neighborhood Traffic Management (NTM) "Tool Box".....	11-3
Table 11-2	Neighborhood Traffic Management Action Plan	11-13
Table 12-1	Parking Facility Priorities by Parking User Type.....	12-10
Table 12-2	Downtown Parking Master Plan Projects	12-14
Table 12-3	Downtown Parking Action Plan	12-14
Table 13-1	Projected Transportation Revenue for the 22-Year Planning Period (in 2012 dollars)	13-5
Table 13-2	Operations, Maintenance, and Capital Costs for the 22-Year Planning Period (in 2012 dollars)	13-6
Table 13-3	Consolidated Action Plan.....	13-10
Table 13-4	Prioritized Master Plan Project List	13-16

1

Executive Summary

The Milwaukie Transportation System Plan (TSP) is the City's long-term plan for transportation improvements and includes policies and projects that could be implemented through the City Capital Improvement Plan, development review, or grant funding. The 2007 TSP planning process was a great opportunity for the community to fully define its transportation goals and discuss how the whole transportation system could be improved to support livability in Milwaukie. The 2013 TSP update process provided an opportunity to ensure that the plan reflected current conditions and took into account the latest forecasts and projections.

Milwaukie is a city of approximately 21,000 people and just under five square miles. Part of Milwaukie is designated as a Town Center in the 2040 Growth Concept. Though Milwaukie's population is expected to grow moderately (approximately one % per year), the city lies at the intersection of several regional transportation facilities and downstream from several areas slated for significant growth in Metro's 2040 Growth Concept.

THE PURPOSE OF A TRANSPORTATION SYSTEM PLAN (TSP)

A primary purpose of an up-to-date TSP is to fulfill the State of Oregon Transportation Planning Rule (TPR) requirements for comprehensive transportation planning in the cities of Oregon. The TSP is a guiding policy document for long-term transportation planning and presents the City's goals and policies while outlining and prioritizing proposed improvements for pedestrian, bicycle, public transit, motor vehicle, and freight systems; downtown parking; and neighborhood traffic management. In addition, the TSP outlines the financial forecast for potential funding and ties that back to potential prioritized improvements to determine any funding shortfalls for projects. When funding shortfalls exist, potential concepts for generating additional revenue are outlined to help guide City funding-related decisions.

The TSP strives to determine existing problem areas for all modes of transportation, looks into the future to identify the needs created by growth, and provide solutions to existing and future needs with guidelines to develop the desired multimodal transportation system. Identifying specific transportation system needs will help the City guide its future transportation system investments and determine how land use and transportation decisions can be brought together beneficially for the community.

After Chapter 4 Future Forecasting Process, each section of the TSP includes a long-range master plan and an action plan. The action plans address those transportation improvements that could be made using limited local funding sources. The final prioritization of transportation

system improvements will be determined by the Milwaukie City Council as part of the annual capital improvements planning and budgeting process.

WHO WAS INVOLVED IN THE CITY'S TSP UPDATES?

During the 2007 TSP update process, the City of Milwaukie launched an extensive public outreach and involvement process (see Appendix B). Citizens, partner agencies, and business representatives were invited to join one or more mode-specific working groups and the TSP Advisory Committee. The working groups were created to focus on different subtasks of the TSP, including: Traffic and Street Network Solutions, Pedestrian and Bike Solutions, Street Design, Transit Solutions, Downtown Parking, and Freight Access. The Advisory Committee oversaw both technical and policy review of the TSP, and offered guidance on the final prioritization of projects and strategies.

In 2013, the City conducted a smaller-scale update to the TSP in order to maintain compliance with Metro's 2035 Regional Transportation Plan (RTP). The public engagement component of the 2013 TSP update was far less intensive than the one in 2007, as the proposed changes did not involve major policy decisions and instead focused on the following elements:

- Update existing figures, tables, and text to reflect current conditions.
- Adjust the TSP's planning horizon year from 2030 to 2035.
- Remove completed projects and update project descriptions as needed.
- Add the final Portland-Milwaukie Light Rail (PMLR) alignment to master plan maps.

The 2013 TSP update, driven by the RTP compliance requirement, allowed the City to confirm that the master plans for the various travel modes (e.g., pedestrian, bicycle, public transit, etc.) will help the region move toward meeting its performance targets for 2035, including reductions in congestion, percentage of single-occupancy vehicle trips, and vehicle miles traveled per capita.

TSP UPDATE PROCESS

In addition to data collection and public involvement, a TSP update consists of seven main elements. The following sections describe each of these elements in more detail.

Goals

Transportation goals and policies form the basis for how the local transportation system will be developed and maintained over the next 22 years. The City's transportation goals support a multimodal approach to transportation planning and reflect how citizens think about and experience Milwaukie's transportation system. The City's nine transportation goals are:

- **GOAL 1 Livability:** Design and construct transportation facilities in a manner that enhances the livability of Milwaukie's community.
- **GOAL 2 Safety:** Develop and maintain a safe and secure transportation system.
- **GOAL 3 Travel Choices:** Plan, develop, and maintain a transportation system that provides travel choices and allows people to reduce the number of trips made by single-occupant vehicles.

- **GOAL 4 Quality Design:** Establish and maintain a set of transportation design and development regulations that are sensitive to local conditions.
- **GOAL 5 Reliability and Mobility:** Develop and maintain a well-connected transportation system that reduces travel distance, improves reliability, and manages congestion.
- **GOAL 6 Sustainability:** Provide a sustainable transportation system that meets the needs of present and future generations.
- **GOAL 7 Efficient and Innovative Funding:** Efficiently allocate available funding for recommended transportation improvements, and pursue additional transportation funding that includes innovative funding methods and sources.
- **GOAL 8 Compatibility:** Develop a transportation system that is consistent with the City's Comprehensive Plan and coordinates with County, State, and regional plans.
- **GOAL 9 Economic Vitality:** Promote the development of Milwaukie's, the region's, and the state's economies through the efficient movement of people, goods, and services, and the distribution of information.

Existing Conditions

Project staff reviewed existing conditions to establish how the transportation systems within Milwaukie currently operate in terms of quality, effectiveness, accessibility, and safety. Sidewalk and pavement conditions, roadway and intersection traffic volumes, transit and freight operations, as well as parking, rail, environmental justice and natural resources were all reviewed with the goal of understanding the "bigger picture" of the City's transportation needs. Additional detail related to these topics can be found in Chapter 3.

Forecasting Future Traffic Conditions

The forecast year for this plan is 2035. The City used Metro's urban area transportation forecast model to forecast future p.m. peak-hour traffic volumes at study area intersections. This is a complex model that takes many anticipated trends in demographics, changes in land use, population, etc. into account when forecasting future traffic volumes. Some of the more important assumptions include the projected growth in population in Clackamas County and the rest of the Metro region, residential and employment growth in downtown Milwaukie, and an increase in transit use within the Metro region. See Chapter 4 for more detail.

Identification of Needs and Potential Improvements

The traffic volume projections forecasted from the Metro model formed the basis for identifying potential roadway deficiencies and evaluating alternative circulation improvements within Milwaukie. Needs for other modes were then identified, based on the future traffic forecasts and deficiencies in the existing infrastructure (sidewalks, bike lanes, transit stops, etc.).

Collectively, the master plans in Chapters 5 through 12 of the TSP describe the proposed capital and operational improvements to the transportation system between 2013 and 2035. While many of these potential improvements are presented as benefiting one mode, when possible, multiple modes are combined into one project. For instance, the Railroad Ave road-widening project listed in the Street Network Master Plan could include new bike lanes and sidewalks, as well as improvements for freight and transit.

Between the 2007 and 2013 TSP updates, the PMLR project became more defined, with construction starting in 2012. A thorough feasibility and impact study was conducted for the

PMLR project, identifying and developing appropriate mitigation for the new light rail system's impacts to Milwaukie's transportation infrastructure. The warranted improvements are being constructed as the new light rail system is being built. Once completed, PMLR will become a part of the City's transportation system and will be further studied to identify and address needed improvements as part of future updates to the TSP.

In June 2013, the Tacoma Station Area Plan (TSAP) was adopted to address potential redevelopment opportunities near the new PMLR station at Tacoma St. The TSAP included a list of approximately 20 projects identified to meet new transportation needs. These projects were assigned order-of-magnitude costs and were added to the relevant project lists for the various modes.

Ranking and Prioritizing Improvements

The action plans in Chapters 5 through 12 focus on the highest priority projects that are most likely to be funded over the next 22 years with limited City funds. The action plans are built upon the premise that, given the limited funds available, the City should prioritize funding of transportation projects that 1) effectively address identified problems, and 2) best meet the City's Goals.

To prioritize the projects as part of the 2007 TSP update, project staff and the Advisory Committee used three sources: the project rankings from the working groups, evaluation of each project against the nine TSP Goals, and other information regarding dependence on other projects, neighborhood support, etc. Using this approach, project staff and the Advisory Committee developed a relative ranking of the projects, grouping them into three categories (high, medium, and low priority).

For the 2013 TSP update, project staff did not reevaluate projects against the nine TSP Goals but, instead, considered the input generated around a public meeting that was held to discuss transportation project priorities. For approximately 20% of the existing projects, the priority classification was adjusted to reflect changes in current conditions or a new awareness of community need. For new projects arising from the Tacoma Station Area Plan (TSAP), staff assigned a priority to each based on input from the TSAP Advisory Committee as well as staff knowledge of overall system needs.

Financing Transportation Projects

The financially constrained action plan lists in Chapters 5 through 12 identify which projects the City should prioritize for funding with limited City funds. While these action plans will set the priorities for use of local funds, they do not assume funding sources such as State or regional grants, or contributions from local development. Therefore, the "financially constrained" lists are very constrained.

Given the limited availability of funding, the City will have to make tradeoffs when deciding how to spend the limited funds each year. As part of the 2007 TSP update, the Advisory Committee determined that the City should use a strategic approach that funds a range of high priority "implementable" projects. This approach encourages the City to tackle smaller projects with local funds, but also use local funds as the required local match to leverage State and federal funds for larger high priority projects. The 2013 TSP update reaffirmed this strategic approach.

The primary function of the TSP is to provide guidance for long-range policy and investment decisions about needed improvements to the transportation system over the next 22 years. The Consolidated Action Plan in Table 13-3 (located in Chapter 13 Funding and Implementation Plan) provides a list of the highest priority projects for the community. This list is utilized to build

the "Transportation Priority Project—Unfunded" section of the City's 5-year Capital Improvement Plan (CIP). The CIP is a list of projects for the City's water, wastewater, stormwater, and transportation systems that are scheduled to be funded in the short term. As funding becomes available, projects are moved from the unfunded section of the CIP to the section recommended for funding. Projects in the CIP section recommended for funding are reviewed by the City Council for funding every 2 years through the City's budgeting process. In essence, the CIP is the primary implementation mechanism for TSP projects.

Recommendations

The Milwaukie TSP focuses on Milwaukie's transportation needs and decisions. Therefore, participants in the 2007 planning process created a set of recommendations that implemented State and regional policies but were tailored to Milwaukie's current and future needs. From all of the input that citizens and businesses offered during the 2007 TSP process, there were some clear messages. The highest priorities established in 2007 for improving transportation in Milwaukie were:

- Improve pedestrian and bicycle facilities throughout the city.
- Enhance public transit service.
- Maintain existing facilities.
- Manage traffic in neighborhoods (address "cut-through" traffic) as regional traffic volumes increase.
- Improve safety and accessibility of crossings over major corridors.

Though it is common for people to be focused on their own street, neighborhood, or bus line, a broad number of people identified the following areas as a priority in 2007:

- Downtown
- Milwaukie Marketplace area
- Railroad Ave
- Railroad crossings throughout the city

The 2013 TSP Update process did not involve the same level or depth of public involvement and discussion, as it was intended as only a minor refresh of the 2007 document. However, public comments gathered at and around a public meeting held in June 2013 largely confirmed the above recommendations (with at least one exception, that there was no clear identification of the Milwaukie Marketplace as a priority area). In 2013, people appear to be generally more supportive of projects that serve to improve multiple modes of transportation than those that enhance only one aspect of the larger transportation system. In addition, there is a clear emphasis on improving east-west connections across the community, especially to mitigate the divisive effect that Hwy 224 has in separating downtown from the predominant population in the eastern neighborhoods.

The following section summarizes the specific recommendations that resulted from the analysis of each mode and aspect, including: pedestrian, bicycle, public transit, motor vehicle, freight, street design, neighborhood traffic management, and downtown parking. Figure 1-1, the Composite Master Plan Map, summarizes the recommended improvements on one map, showing the location of recommended master plan improvements for pedestrian, bicycle, public transit, motor vehicle, and freight modes.



Transportation System Plan

FIGURE 1-1

COMPOSITE MASTER PLAN

November 2013

Legend

- Schools
- Light Rail Station
- Light Rail Transit
- Kellogg Creek Trail
- Springwater Trail
- Trolley Trail
- Railroad
- Streets
- Major Roads
- County Line
- Water
- Parks
- City Limits

Proposed Projects

- Bicycle Corridor Improvement
- Pedestrian Corridor Improvement
- Transit Corridor Improvement
- Freight Intersection Improvement
- Bicycle Intersection Improvement
- Pedestrian Intersection Improvement
- Auto Intersection Improvement



DKS Associates
TRANSPORTATION SOLUTIONS

0 500 1,000 2,000 3,000 4,000 Feet

PEDESTRIAN FACILITIES

Walking is the most affordable and accessible of all transportation modes. It is also clean, low-impact, and healthy for the individual. A safe and comfortable pedestrian environment allows people of all ages and abilities to travel independently.

Milwaukie's pedestrian system is challenged by an incomplete arterial/collector sidewalk system, a lack of local street connectivity, arterial crossings with potential safety and connectivity issues, and a lack of complete multiuse trails (see Chapter 3).

The City has several strategies for addressing pedestrian system needs and guiding project prioritization. The prioritization process helps to focus community investment on those projects that are most effective at addressing critical needs, while deferring other projects of lesser importance. The strategies for pedestrian facilities include:

- Key pedestrian corridors to connect neighborhoods with schools, parks, activity centers, and major transit stops.
- Arterial crossing and safety enhancements.
- Fill gaps in the network where some sidewalks exist.
- Pedestrian corridors that connect to major recreational uses.
- Enforcement of laws that protect pedestrians.
- Education about pedestrian safety and available walking routes.

These strategies would be implemented by projects that address needs and deficiencies.

Key Recommendations

- **Arterial and Collector Street Improvements:** Construct walkways along key collector and arterial streets, especially when project is publicly funded:
 - Monroe St from 42nd Ave to eastern city limit
 - Stanley Ave within the city limits
 - Linwood Ave within city limits
 - 17th Ave north of downtown
 - Railroad Ave within the city limits
- **Local Street Improvements:** Walkways on local streets will be mostly constructed by new/infill development.
- **Intersection Improvements:** Construct intersection improvements to improve pedestrian safety near Hwy 224 and the Milwaukie Marketplace:
 - Oak St by the railroad tracks
 - Harrison St and Hwy 224
 - Railroad Ave and 37th Ave
- **Develop and distribute walking maps** that show routes to major destinations such as parks, schools, commercial areas, and trails.
- **Enforce against motorists** who speed and run stop signs.



Transportation System Plan

FIGURE 1-2

PEDESTRIAN MASTER PLAN

April 2015

LEGEND

Existing Sidewalks	Proposed Improvement
< 5 ft width	Pedestrian Intersection Safety Improvement
5 ft - 10 ft width	Pedestrian Facilities
Kellogg Creek Trail	Central Milwaukie 2015 TSP Amendments
Springwater Trail	Light Rail Station
Trolley Trail	Light Rail Station
Schools	County Line
Major Roads	10' Contours
Streets	Water
Railroad	Parks
City Limits	Light Rail Transit

PROPOSED PROJECTS

Improve Intersection to Increase Pedestrian Safety

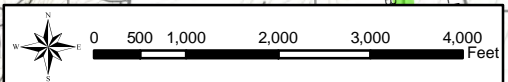
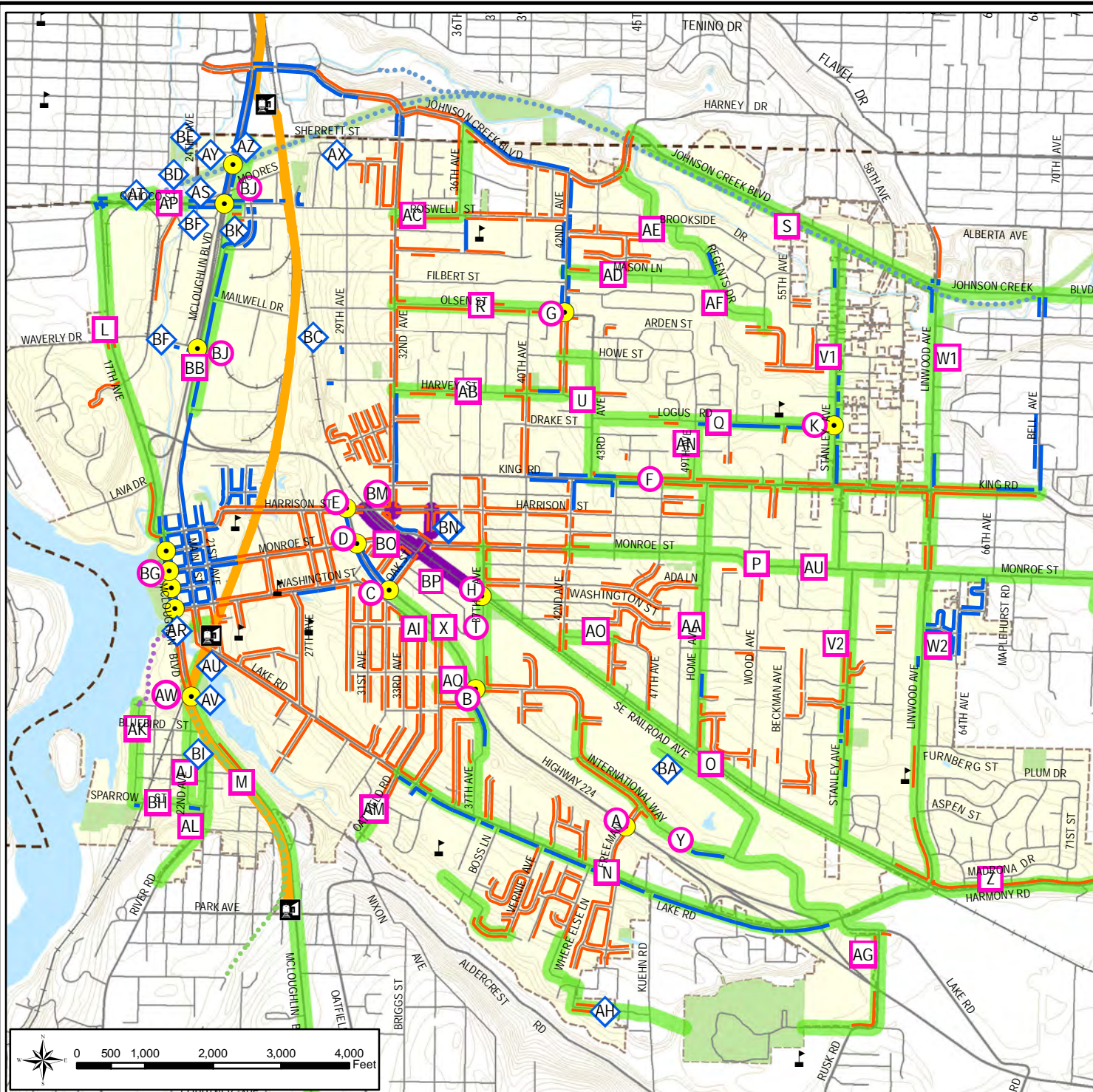
- A Freeman Way/HWY 224
- B 37th Ave/HWY 224
- C Oak St/HWY 224
- D Monroe St/HWY 224
- E Harrison St/HWY 224
- F King Rd improvements
- G Olsen St/42nd Ave
- H Railroad Ave/37th Ave
- K Stanley Ave/Logus Rd
- AW McLoughlin Blvd and 22nd Ave
- BC All McLoughlin crossings
- BJ McLoughlin and Ochoco/Milport

Provide Pedestrian Facilities Where Not Currently Present
See Table 5-1 for project descriptions L-AG, AI-AQ, BB, BH

Enhance Existing Pedestrian Connection

- AI Create ped connection from Rowe Middle School to North Clackamas Park
- AR Construct pedestrian underpass under HWY 99E at Kellogg Creek
- AT Complete Springwater Trail along Ochoco St
- AU Construct bike-ped overpass over Kellogg Creek
- AV Construct Kronberg Park Trail
- AX Pave connection to Springwater Trail at 29th Ave and Sherrett
- AY Improve connection from Springwater Corridor to Pendleton Site
- AZ Construct stairs to connect Springwater Corridor to LRT Station
- BA Establish bike-ped connection across Railroad Ave and tracks
- BC Establish bike-ped connection over railroad tracks and LRT
- BD Construct stairs from Springwater Corridor to McLoughlin Blvd
- BE Construct bike-ped bridge over Johnson Creek along Clatsop St at 23rd Ave to connect to LRT station
- BF Improve bike-ped connection to neighborhoods west of station
- BI Establish bike-ped connection over McLoughlin at River Rd
- BK Establish bike-ped connection to McLoughlin at Stubb St

Provide Improved Pedestrian Facilities in Central Milwaukie
See Table 5-1 for project descriptions BM, BN, BO, and BP



Original Map Created by DKS Associates in 2007, Amended by the City of Milwaukie in 2013 and 2015

BICYCLE FACILITIES

The bicycle is a human-powered vehicle that allows people of all ages to move independently, at relatively low cost and with little impact to the environment. Bicycling promotes the well-being of people who live and work in Milwaukie, with the added benefit of reducing auto traffic on city streets.

Milwaukie's existing bicycle system is deficient in three primary ways: lack of connectivity, difficult crossings, and insufficient street designations. Recommended improvements should be aimed at closing the gaps in the bicycle network, improve crossing safety, maintaining the existing system, improving signage, and educating bicyclists and motorists.

Key Recommendations

- **Neighborhood Greenway Improvements:** Prioritize "neighborhood greenways" (also sometimes referred to as "bike boulevards") as a method for providing safe bikeway connections to other transportation modes and between parks, schools, activity centers, and regional destinations. Establish neighborhood greenways along the following routes:
 - Monroe St from downtown to Linwood Ave
 - Stanley Ave from Railroad Ave to Springwater Trail
 - 29th Ave from Springwater Trail to Monroe St (via Harvey St and 40th Ave)
 - 19th Ave and Sparrow St to Trolley Trail
- **Bikeway Improvements:** Improve existing bikeways by paving, striping, adding signage, establishing bike lanes where appropriate, etc.
- **Intersection Improvements:** Make key intersections safer and more functional for bicyclists with treatments such as improved striping, accessible signal buttons, and bicycle detection devices.
- **Education:** Improve education for bicyclists and drivers and encourage bicycling through planned bicycling events.
- **Maintenance:** Keep bike lanes clear of debris.
- **Coordination with Other Jurisdictions:**
 - Work with other jurisdictions on long-range projects such as route connectivity and trail system planning and construction.
 - Improve response on day-to-day issues such as sweeping out bike lanes and enforcing traffic and parking laws.



Transportation System Plan

FIGURE 1-3

BICYCLE MASTER PLAN

April 2015

LEGEND

Existing Bicycle Facilities		Proposed Improvements	
	Shared Lane		Bicycle Intersection Safety Improvement
	Bicycle Lane		Bicycle Lanes
	Kellogg Creek Trail		Neighborhood Greenway
	Springwater Trail		Central Milwaukee 2015 TSP Amendments
	Trolley Trail		

	Schools		Railroad		City Limits
	Major Roads		Water		Light Rail Station
	Streets		Parks		Light Rail Transit

PROPOSED PROJECTS

- Improve Intersection to Increase Bicycle Safety**
- Adams St/21st Ave/Railroad Crossing
 - Johnson Creek Blvd/Springwater Trail
 - Johnson Creek Blvd/Linwood Ave
 - Linwood Ave/King Rd
 - Linwood Ave/Monroe St
 - Linwood Ave/Harmony Rd
 - Washington St/Oak St/Hwy 224
 - International Way/Lake Rd
 - McLaughlin and 22nd
 - McLaughlin/Ochoco/Milport

Provide Bicycle Lanes Where not Currently Present
See Table 6-2 for project descriptions B-R, AI, and AJ

- Enhance Existing Bicycle Connection**
- Install Neighborhood Greenway treatments at various locations
 - Construct bicycle overpass from Railroad Ave to International Way
 - Improve Springwater Trail paving
 - Improve Kellogg Creek Trail
 - Install Trolley Trail signage
 - Fill in gaps in existing bike network with bike lanes or multiuse path. Improve intersection safety on 17th Ave at HWY 224 and at 99E.
 - Complete Springwater Trail along Ochoco St
 - Construct Kronberg Park Trail
 - Construct bike-ped overpass over Kellogg Creek
 - Construct pedestrian underpass under HWY 99E at Kellogg Creek
 - Pave connection to Springwater Trail at 29th Ave and Sherrett
 - Improve connection from Springwater Corridor to Pendleton Site
 - Establish bike-ped connection over railroad tracks and LRT
 - Construct stairs to connect Springwater Corridor to McLaughlin Blvd
 - Construct bike-ped bridge over Johnson Creek along Clatsop St at 23rd Ave to connect to LRT station
 - Improve bike-ped connection to neighborhoods west of station
 - Establish bike-ped path on Sparrow to connect River Rd to Trolley Trail
 - Establish bike-ped connection over McLaughlin at River Rd
 - Establish bike-ped connection to McLaughlin at Stubb St

Provide Improved Bicycle Facilities in Central Milwaukee
See Table 6-2 for project descriptions AS, AT, AU, AV, and AW



PUBLIC TRANSIT FACILITIES

The availability, convenience, and desirability of public transit are key aspects of a system that must support the movement of people to, from and through Milwaukie. Transit trips reduce single-occupant vehicle trips (which reduces traffic and energy consumption), serves community members who cannot drive (including the elderly, disabled, and youth), and minimizes transportation system impacts to the environment, such as vehicle emissions and soil and water pollution from impervious surface runoff.

Though transit service in Milwaukie needs to be improved in many ways, its greatest deficiencies are in the areas of service levels, safety, and convenience of service. There is a disparity between the City's goals for transit service and use, and the system's ability to meet those goals today. To close this gap, the City and TriMet should simultaneously pursue three types of improvements: service enhancements, capital improvements, and policy improvements.

Key Recommendations

- **Service Enhancements:**
 - Add a bus route on Railroad Ave (extending to Clackamas Town Center via Harmony Rd)
 - Add a bus route on Johnson Creek Blvd
 - Reduce headways to less than 30 minutes on all routes.
 - Enhance service on north-south routes.
 - Improve reliability of all routes.
- **Capital Improvements:**
 - Install shelters at bus stops that meet TriMet criteria.
 - Improve downtown bus stops and shelters, and include ample bike parking.
 - Construct a new bus layover facility at the Southgate park-and-ride.
- **Policy Recommendations:**
 - Eliminate the layover function of the downtown transit center.
 - Expand transit service. Provide service in "transit disadvantaged" areas. Fund local service enhancements through savings made from transit capacity improvements.
 - Provide appropriately located and sized park-and-ride facilities. Provide park-and-rides on Milwaukie's fringe for commuters and park-and-rides inside Milwaukie for Milwaukie residents.
 - Improve transit safety.
 - Reinvest transit "savings" within Milwaukie. Any savings derived from new capacity should be contained and reinvested within the Milwaukie service area.



Transportation System Plan

FIGURE 1-4

PUBLIC TRANSIT MASTER PLAN

November 2013

LEGEND

Existing Facilities

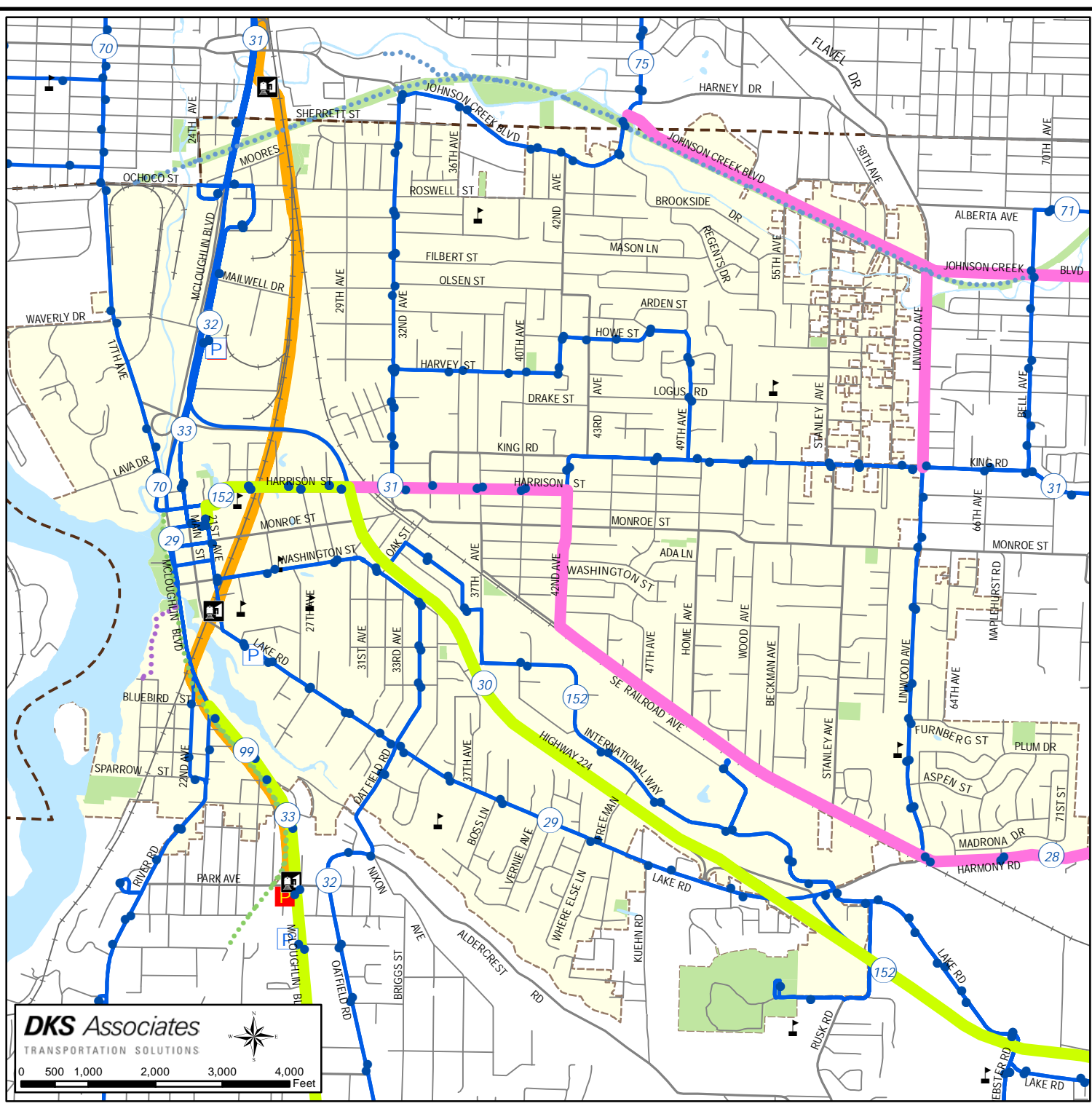
- Bus Route Number
- Bus Stop
- Bus Route
- Light Rail Station
- Light Rail Transit
- Park-and-Ride

Proposed Improvements

- Park-and-Ride
- New or Rerouted Bus Route
- Bus Rapid Transit Route

Other Map Features

- Schools
- Major Roads
- Streets
- Railroad
- Kellogg Creek Trail
- Springwater Trail
- Trolley Trail
- County Line
- Water
- Parks
- City Limits



DKS Associates
TRANSPORTATION SOLUTIONS

0 500 1,000 2,000 3,000 4,000 Feet

MOTOR VEHICLE FACILITIES

The Street Network element of the TSP focuses on maintaining motor vehicle traffic flow and mobility on arterial and collector roadways, protecting residential neighborhoods from excessive through traffic and travel speeds, providing reasonable access to and from residential areas, improving safety, and promoting efficient through-street movement.

Limited connectivity between Milwaukie neighborhoods often forces motorists to travel out of direction and increases traffic volumes and miles traveled on the few connecting streets. Regional and local traffic volumes are projected to increase on many city streets and cause many intersections to operate below jurisdictional standards.

Key Recommendations

- **Use Transportation System Management** to get the most out of the existing system.
- **Improve substandard streets and intersections** to accommodate traffic and improve safety.
- **Enhance neighborhood character and livability** through well-designed street improvements.
- **Leverage Street Surface Maintenance projects** to bring roads up to standards when possible.
- **Initiate a Hwy 99E/Hwy 224 Refinement Plan** with ODOT to define the future conditions of this corridor. Assumptions to include:
 - Primary crosstown connection is Harrison St.
 - Improve freight access to North Industrial area
 - Multiple grade-separated connections between Harrison St and Freeman Way.
 - Reduce the visual and physical "barrier" effect of the highway for nonmotorized modes of travel.
- **Implement capacity improvement projects on key corridors** as needed:
 - Harrison St/Main St
 - Harrison St/42nd Ave/King Rd
 - Johnson Creek Blvd/Linwood Ave
 - King Rd/Linwood Ave
 - Monroe St



Transportation System Plan

FIGURE 1-5

STREET NETWORK MASTER PLAN

November 2013

LEGEND

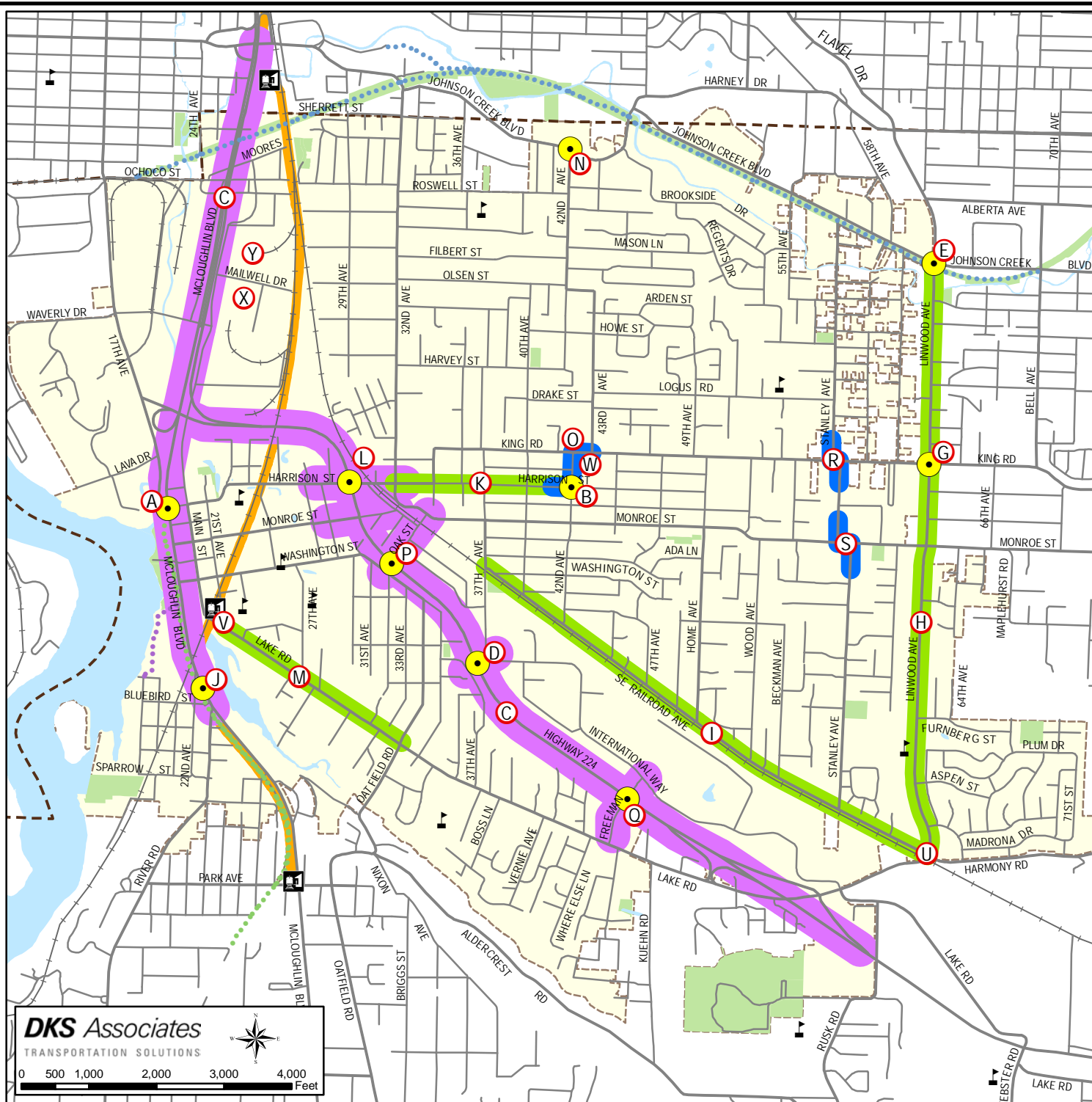
Proposed Street Network Improvements

	Travel Route Improvement		Corridor Refinement Plan
	Roadway Widening Project		Intersection

	Schools		Major Roads
	Kellogg Creek Trail		Streets
	Springwater Trail		Railroad
	Trolley Trail		County Line
	Light Rail Station		Water
	Light Rail Transit		Parks
			City Limits

PROPOSED PROJECTS

- A** Prohibit left turn movement at 17th Ave/McLoughlin Blvd and include in Refinement Plan
- B** Signalize Harrison St/42nd Ave
- C** Conduct Refinement Plan for HWY 99E/HWY 224 focused on motor vehicle and freight mobility.
 - HWY 99E Project Limits: Tacoma St to 17th Ave
 - HWY 224 Project Limits: HWY 99E to Lake Rd Interchange
- D** Reconfigure intersection to consolidate 37th Ave/Industrial Way
- E** Add eastbound/westbound right turn lanes and integrate the trail crossing
- G** Implement protected/permitted phasing for northbound and southbound left turns
- H** Widen Linwood Ave to standard three lane cross section
- I** Widen Railroad Ave to standard three lane cross section
- J** Redesign intersections of River Rd and 22nd Ave to consolidate intersections; or
Add northbound left turn pocket on River Rd
- K** Widen Harrison St to standard three-lane cross section
- L** Add left turn-lanes and protected signal phasing on Harrison St approaches
- M** Widen Lake Rd to standard three-lane cross section
- N** Replace 3-way stop with signal when warranted and appropriate. (Coordinate with the City of Portland)
- O** Enhance connection between King Rd and Harrison St
- P** Add protected signal phasing on Oak St approaches
- Q** Improve intersection/modify access at HWY 224 and Freeman Way
- R** Enhance connection along Stanley Ave at King Rd
- S** Enhance connection along Stanley Ave at Monroe St
- V** Improve safety of Trolley Trail crossing at 22nd Ave
- W** Realign intersection to improve traffic between 42nd Ave and King Rd east of 42nd Ave
- X** Connect local streets within Tacoma Station Area (See Fig 8-4)
- Y** Construct street improvements on Stubb St, Beta St, Ochoco St, Hanna Harvester Dr and Mailwell Dr (TSAP)



DKS Associates
TRANSPORTATION SOLUTIONS

0 500 1,000 2,000 3,000 4,000 Feet

FREIGHT PLAN

A quality local freight network facilitates movement of bulk goods and materials, and is essential to the economic health of the city. While all cities have some need for local delivery of goods to retailers and similar activities, in Milwaukie a majority of employment is in the heavy manufacturing, warehousing, and distribution sectors, which are dependent on efficient movements of large quantities of both raw materials and finished products. A well-functioning and reliable system for the movement of freight into and out of the city contributes significantly to the City's ability to attract and retain industrial investment—and the jobs and tax proceeds that come with that investment.

The city's freight network faces a few specific challenges. Access to the North Industrial area from McLoughlin Blvd is limited due to turn restrictions at Milport Rd and Ochoco St. Most rail crossings exhibit deterioration due to wear and tear and frequent train crossings, resulting in increased delay for the general public and freight haulers. The number of routes available to trucks is limited by weight limitations on certain freight routes and narrow intersections.

Key Recommendations

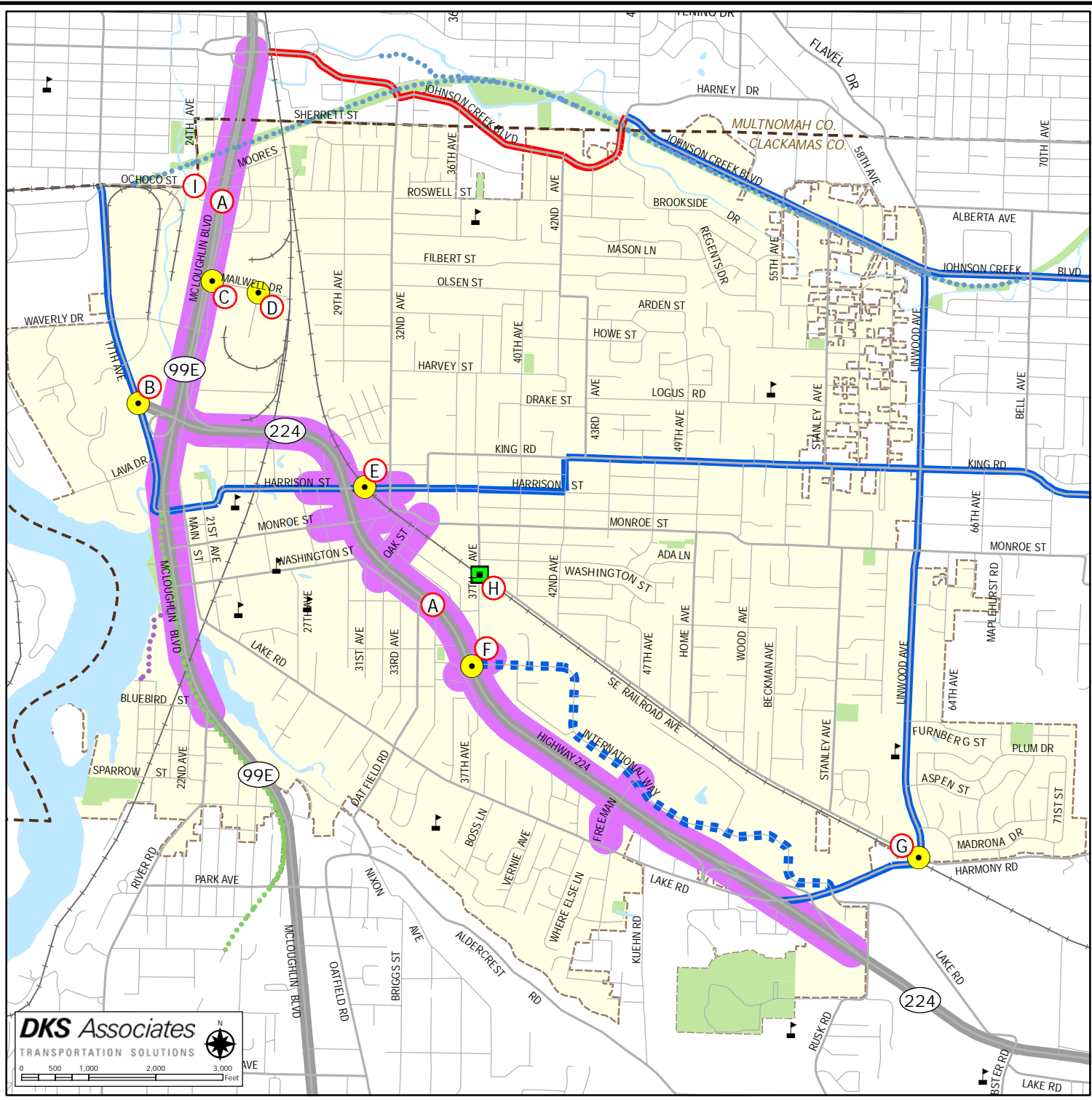
- **North Industrial Access:** Improve access to the area, potentially with an overpass of Hwy 99E at Ochoco St. This and other solutions should be evaluated through a Hwy 99E/224 Refinement Plan (described in the previous section).
- **Rail Crossings:** Improve the quality of the materials at at-grade crossings and pursue the grade separation of key crossings.
- **Street Reclassification:** Designate International Way as a freight route.



Transportation System Plan

FIGURE 1-6

FREIGHT MASTER PLAN November 2013



LEGEND

Existing Freight Routes	Proposed Improvements
Major Regional	Intersection Improvement
Minor Preferred (Local)	Intersection Material Upgrade
Weight Restricted Minor Preferred (Local)	Corridor Refinement Plan
Minor Preferred Freight Route (Local)*	Minor Preferred Freight Route (Local)*
Major Roads	County Line
Streets	Parks
Railroad	Water
Springwater Trail	City Limits
Kellogg Creek Trail	
Trolley Trail	

PROPOSED PROJECTS

- Improve Corridor**
- A** Conduct Refinement Plan for HWY 99E/HWY 224 focused on motor vehicle and freight mobility.
 - HWY 99E Project Limits: Tacoma St to 17th Ave
 - HWY 224 Project Limits: HWY 99E to Lake Rd Interchange
- Improve Intersection**
- B** 17th Ave/HWY 224 Upgrade intersection turning radii to better accommodate freight movements
 - C** Main St/Mailwell Dr Upgrade intersection turning radii to better accommodate freight movements
 - D** Mailwell Dr/Omark Dr Upgrade intersection turning radii to better accommodate freight movements
 - E** Harrison St/Union Pacific Railroad Crossing Upgrade crossing to grade separated facility (outcome of crossing dependant upon 99E/224 Refinement Plan findings)
 - F** HWY 224/37th Ave Consolidate two northern legs of 37th Ave and Industrial Way into one leg at HWY 224.
 - G** Linwood/Harmony/Lake Road Intersection Improvements Add northbound right turn lane and eastbound right turn lane AND/OR grade separate Harmony Road from Union Pacific Railroad and align as a through east-west movement
 - H** Railroad Crossing Improvements at 37th Ave Improve road transition to railroad crossing
 - I** Signage and Intersection Improvements at McLoughlin Boulevard and Ochocho St. Establish signage for trucks and improve intersection (TSAP)

STREET DESIGN

A street's design determines how it will look and function. How a street looks and functions ultimately depends upon which elements are included, their dimensions, and how they relate to each other. Well-designed streets can contribute to the identity and character of a neighborhood and increase property values. They can also speed or slow traffic, reduce environmental impacts, and allow for safe multimodal use.

Problems

Milwaukie is a developed city with a largely incomplete street network. Though the community supports the completion of its streets through construction of safe pedestrian and bicycle facilities, most neighborhoods also want to maintain neighborhood character by saving existing trees and maintaining the slower traffic speeds that often accompany substandard roads. The City's current design standards limit the City's ability to sensitively improve existing streets by only allowing a few street design options. Allowing for more flexibility when determining the design of a street would allow for the City to respond to the character of the surrounding natural and built environments.

Possible Solutions

The City should update its standards and policies to allow for implementation of context-sensitive street design. The use of innovative designs, such as green streets, skinny streets, and flexible pedestrian designs are some examples of street design options that the City could incorporate into its street design standards.

Key Recommendations

- **Standards:** Develop a baseline cross section for each street functional classification and a street design prioritization approach for when the baseline design elements do not fit.
- **Flexibility:** Build more flexibility into street design standards to:
 - Allow for local design preferences.
 - Increase bicycle and pedestrian safety.
 - Avoid costly and time-consuming variance process requirements.
- **Alternative Designs:** Develop street design standards for green streets, skinny streets, and alternative pedestrian facilities.
- **Balance:** Balance the larger community's needs, local design preferences, and best practices when developing street design standards.
- **Landscaping:** Provide for landscaping (including street trees) wherever feasible.
- **Maintenance:** Consider maintenance costs and issues when developing design standards and design alternatives.

NEIGHBORHOOD TRAFFIC MANAGEMENT

The City recognizes that the vitality and feel of a neighborhood can be greatly influenced by the speed and volume of traffic traveling to and through it. Neighborhood traffic management is a way for the City and its citizens to create a dialogue about traffic concerns on a neighborhood level.

Problems

Milwaukie consists mostly of residential neighborhoods, and has a relatively small population compared to the surrounding Portland metropolitan area. Because of its proximity to the city of Portland, its many employment opportunities, and the two major regional routes that traverse the city (McLoughlin Blvd and Hwy 224), cut-through traffic is an ongoing concern for Milwaukie residents. As traffic volumes increase and congestion occurs on regional routes and major streets, there is potential for traffic to spill over onto neighborhood routes and local streets in search of less congested or more direct routes. Neighborhood traffic management is a means to address the negative impacts of unchecked speed and volume on neighborhood and local streets.

Possible Solutions

There are many different options available in the neighborhood traffic management 'tool box,' but not all of these options are appropriate for all streets. Traffic management options need to be based on the functional classification of the road, surrounding land uses, the design of the street, as well as input from emergency services and residents. Effective use of neighborhood traffic management in Milwaukie can address community needs and concerns, including, but not limited to, the following:

- Speeding
- Cut-through traffic
- Pedestrian safety
- Student safety around school zones

Key Recommendations

- **Funding:** It is recommended that the City annually fund the Walk Safely Milwaukie Program so that prioritized needs are implemented over time. The Neighborhood Traffic Management Action Plan (see Table 11-2) does not identify specific projects, but it does show the level of funding the City aspires to commit to the Walk Safely Milwaukie Program for the duration of this plan. With regard to this funding, it is recommended that the City develop a process that ensures neighborhood traffic management funding is equitably distributed throughout the city.
- **Investment:** Allocate a certain amount of money per year to install selected neighborhood traffic management projects. The number of projects would be limited but coordinated with citizen involvement. Encourage implementation of neighborhood traffic management projects by private development.
- **Variety:** Allow for a wide variety of traffic management measures.
- **Effectiveness:** Ensure that the chosen measure addresses the identified problem.
- **Neighborhood Input:** Involve affected neighborhoods when designing neighborhood traffic management measures.
- **Landscaping:** Neighborhood traffic management solutions need to provide for landscaping wherever feasible.
- **Maintenance:** Consider maintenance needs and issues (including landscaping) when designing traffic management measures and ensure that the long-term maintenance needs can be met.

DOWNTOWN PARKING

Properly managed downtown parking is vital for implementing and maintaining the City's 2001 *Downtown and Riverfront Land Use Framework Plan*. This plan envisions a lively downtown area with a clear sense of place and identity, comprised of an attractive mix of uses and amenities. The city's downtown area will grow as an important employment center and therefore parking must be built and managed to serve the retail core as downtown transitions to a multimodal environment.

Problems

Currently, downtown Milwaukie is vulnerable to serving as an impromptu park-and-ride for people traveling to downtown Portland. Downtown residents and employees are parking in spaces that should serve visitors, which causes parking to spill over into neighborhoods. The parking lots that are available, and some downtown streets, are not well lit and do not feel safe. Downtown employees are often not aware of their parking and transportation options and the current parking permit system does not work as well as it could. As the downtown area evolves, the existing parking lots will be developed and other parking options will need to be considered.

Possible Solutions

There are two viable solutions Milwaukie can use to improve the downtown parking situation: parking management and parking supply. Parking must be managed to assure that priority land uses are supported with an effective and efficient system of access that caters to the needs of priority users. The City and the private sector can also invest in new parking supply to support downtown development.

Key Recommendations

- **Manage parking to support downtown revitalization**, according to the vision in the Downtown and Riverfront Plan. Manage on-street parking to serve adjacent ground-floor uses.
- **Keep an updated parking inventory** and conduct periodic parking use studies to understand how parking areas are used.
- **When parking areas are over 85% full**, adjust parking management practices to make the best use of available parking (adjust parking zones, increase prices, install parking meters, etc.).
- **Require the private sector to identify sufficient parking** for residential and commercial uses, but do not ask developers to "over-build" parking. Encourage shared parking arrangements.
- **Provide public off-street parking for downtown employees** as funds and property availability allows. First priority will be given to buildings and businesses existing in 2007.
- **Work with property and business owners** to decrease employees' need for auto parking as downtown transitions to a multimodal environment.
- **Develop a plan to locate a public parking structure** to support downtown, but only in collaboration with the downtown business community and only after a viable funding strategy is identified.

2

Goals and Policies



OVERVIEW

Transportation goals and policies form the basis for how the local transportation system will be developed and maintained over the next 22 years. The City's transportation goals support a multimodal approach to transportation planning and reflect how citizens think about and experience Milwaukie's transportation system.

The policy framework of this plan is organized as follows:

- **Goal Statement:** A statement that describes an ideal condition that the City desires to attain over time for various aspects of the transportation system. For example: Provide access to safe, affordable, and reliable transportation choices for all Milwaukie residents and businesses.
- **Policy Statements:** Statements that are intended to outline specific measures that will be taken to achieve a goal.

The following section lists the goals and policies for the Milwaukie Transportation System Plan (TSP). They are not listed in order of importance or priority, but rather are all aspects that need to be considered when developing, funding, and managing the transportation system.

GOAL 1 LIVABILITY

Design and construct transportation facilities in a manner that enhances the livability of Milwaukie's community.

Policies

- a. Provide convenient walking and bicycling facilities to promote the health and physical well being of Milwaukie citizens.
- b. Protect residential neighborhoods from excessive through traffic and travel speeds while providing reasonable access to and from residential areas.
- c. Protect residential neighborhoods from excessive noise and pollutants associated with higher functional class streets, industrial uses, and rail activities.

- d. Minimize the "barrier" effect of large transportation facilities on nonmotorized modes of travel.
- e. Construct a transportation system that is accessible to all members of the community.
- f. Provide a seamless and coordinated transportation system that is barrier-free, provides affordable and equitable access to travel choices, and serves the needs of all people and businesses, including citizens of low income, people with disabilities, children, and seniors.

GOAL 2 SAFETY

Develop and maintain a safe and secure transportation system.

Policies

- a. Design and maintain safe and secure walkways and bikeways between parks, schools, and other activity centers in Milwaukie.
- b. Design and construct transportation-related improvements to meet City standards as outlined in the City's Transportation Design Manual and the Americans with Disabilities Act (ADA).
- c. Adopt and implement access control and spacing standards for all streets under the City's jurisdiction to improve safety and promote efficient through-street movement. Access control measures should be generally consistent with Clackamas County access guidelines to ensure consistency on City and County roads.
- d. Improve riders' sense of safety at transit stops through lighting, design, and enforcement.

GOAL 3 TRAVEL CHOICES

Plan, develop, and maintain a transportation system that provides travel choices and allows people to reduce the number of trips made by single-occupant vehicles.

Policies

- a. Provide a citywide network of convenient walkways and bikeways that are integrated with other transportation modes and regional destinations.
- b. Collaborate with TriMet and other transit providers to provide convenient and accessible public transit service to all Milwaukie neighborhoods.
- c. Support travel options that allow individuals to reduce single-occupant vehicle trips.
- d. Establish local non-single-occupancy-vehicle (non-SOV) modal targets, subject to new data and methodology made available to local governments, for all relevant design types identified in the Regional Transportation Plan. Targets must meet or exceed the regional modal targets for 2040 Growth Concept land use design types as illustrated in Table 2-1.

Table 2-1 2040 Regional Metro Targets for Non-Single-Occupant Vehicles (non-SOVs)

2040 Design Type	Modal Target
Regional centers, town centers, main streets, station communities, corridors, passenger intermodal facilities	45% to 55%
Industrial areas, freight intermodal facilities, employment areas, inner neighborhoods, outer neighborhoods	40% to 45 %

- e. Encourage local employment and commercial job creation in order to reduce the number of locally generated regional work and shopping trips.
- f. Ensure bike and bus routes are well separated, marked, mapped, and marketed.
- g. Ensure that savings derived from adding capacity (LRT or other) is reinvested in local service enhancements for Milwaukie.

GOAL 4 QUALITY DESIGN

Establish and maintain a set of transportation design and development regulations that are sensitive to local conditions.

Policies

- a. Design streets to support their intended users.
- b. Integrate bicycle and pedestrian facilities into street planning, design, construction, and maintenance activities.
- c. Require developers to include pedestrian-, bicycle-, and transit-supportive improvements within proposed developments and adjacent rights-of-way in accordance with adopted policies and standards.
- d. Promote context-sensitive transportation facility design, which fits the physical context, responds to environmental resources, and maintains safety and mobility.
- e. Consider maintenance costs and issues when developing and implementing design standards.
- f. Promote landscaping and pervious surfaces wherever practical and feasible.

GOAL 5 RELIABILITY AND MOBILITY

Develop and maintain a well-connected transportation system that reduces travel distance, improves reliability, and manages congestion.

Policies

- a. Enhance street system connectivity wherever practical and feasible. In particular, improve east-west connectivity across the community, especially to connect the eastern neighborhoods across Hwy 224 to downtown.

- b. Maintain traffic flow and mobility on arterial and collector roadways.

GOAL 6 SUSTAINABILITY

Provide a sustainable transportation system that meets the needs of present and future generations.

Policies

- a. Encourage an energy efficient transportation system.
- b. Increase the use of walking and bicycling for all travel purposes.
- c. Improve and enhance the livability of Milwaukie by decreasing reliance on automobile transportation and increasing the use of other modes to minimize transportation system impacts on the environment.
- d. Practice stewardship of air, water, land, wildlife, and botanical resources. Take into account the natural environments in the planning, design, construction, and maintenance of the transportation system.

GOAL 7 EFFICIENT AND INNOVATIVE FUNDING

Efficiently allocate available funding for recommended transportation improvements, and pursue additional transportation funding that includes innovative funding methods and sources.

Policies

- a. Plan for an economically viable and cost-effective transportation system.
- b. Identify and develop diverse and stable funding sources to implement recommended projects in a timely fashion.
- c. Prioritize maintenance of the transportation system.
- d. Identify local street improvement projects that can be funded by the State of Oregon to improve the performance of the State highway system.
- e. Provide funding for local match share of jointly funded capital projects with other public partners.
- f. Prioritize funding of projects that are most effective at meeting the goals and policies of the TSP.

GOAL 8 COMPATIBILITY

Develop a transportation system that is consistent with the City's Comprehensive Plan and coordinates with County, State, and regional plans.

Policies

- a. Coordinate and cooperate with adjacent jurisdictions and other transportation agencies to develop transportation projects that benefit the city of Milwaukie and the region as a whole.
- b. Work collaboratively with other jurisdictions and agencies so the transportation system can function as one.
- c. Coordinate with other jurisdictions and community organizations to develop and distribute transportation-related information.
- d. Review City transportation standards periodically to ensure consistency with regional, State, and federal standards.
- e. Coordinate with TriMet, the Milwaukie Center, and adjacent jurisdictions to identify existing and future transit-related needs, including placement of park-and-ride facilities.
- f. With ODOT's assistance, coordinate with railroad companies to provide a viable commercial railroad system in and through Milwaukie.
- g. Coordinate with ODOT to address improvements to State highways within Milwaukie to benefit all modes of transportation.

GOAL 9 ECONOMIC VITALITY

Promote the development of Milwaukie's, the region's, and the state's economies through the efficient movement of people, goods, and services, and the distribution of information.

Policies

- a. Ensure a safe and efficient freight system that facilitates the movement of goods to, from, and through Milwaukie, the region, and the state while minimizing conflicts with other travel modes.
- b. Consider constructing grade separation or gate control for all railroad crossings.
- c. Provide transportation facilities that support land uses that are consistent with the Comprehensive Plan.
- d. Evaluate land development projects to determine possible adverse traffic impacts.
- e. Ensure that all new development contributes a fair share toward on-site and off-site transportation system improvements.
- f. Manage parking in downtown to support revitalization, according to the vision in the *Milwaukie Downtown and Riverfront Plan*. The purpose of, and priority for, on-street parking in downtown is to support the vitality of the retail core.

3



Existing Conditions

The main objective of Milwaukie's Transportation System Plan (TSP) is to inventory, evaluate, and plan for all modes of travel. The purpose of this chapter is to document the existing transportation facilities in the TSP study area, and provide a basis of knowledge and benchmarks for assessing the physical and operational needs of the system.

OVERVIEW

Existing transportation conditions in Milwaukie were evaluated in late 2006. The existing traffic and transportation conditions for the following modes of travel and items that affect the transportation environment were inventoried and analyzed:

- Pedestrians
- Bicycles
- Public Transit
- Motor Vehicle
- Rail
- Parking
- Environmental Justice
- Environmental Resources

This list of areas covered includes two topics not previously included in the 1997 TSP: environmental justice and environmental resources. Environmental justice with respect to transportation is aimed at identifying underserved and vulnerable populations to help increase outreach efforts to adequately serve those areas within the city. The environmental resources evaluation within this document helps to identify and map environmentally sensitive areas with respect to flood plains, fish and wildlife habitat, wetlands, vegetation, and local historical resources.









The city of Milwaukie is located within Clackamas County just south of the city of Portland. Figure 3-1a shows the location of Milwaukie with respect to the Portland metropolitan region. The study area for this analysis is defined as approximately 1/4 mile beyond the city of Milwaukie boundary limits and includes twenty-two intersections that were selected to address major roadways and areas of concern. Figure 3-1b shows this study area and the study area intersections.

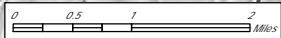
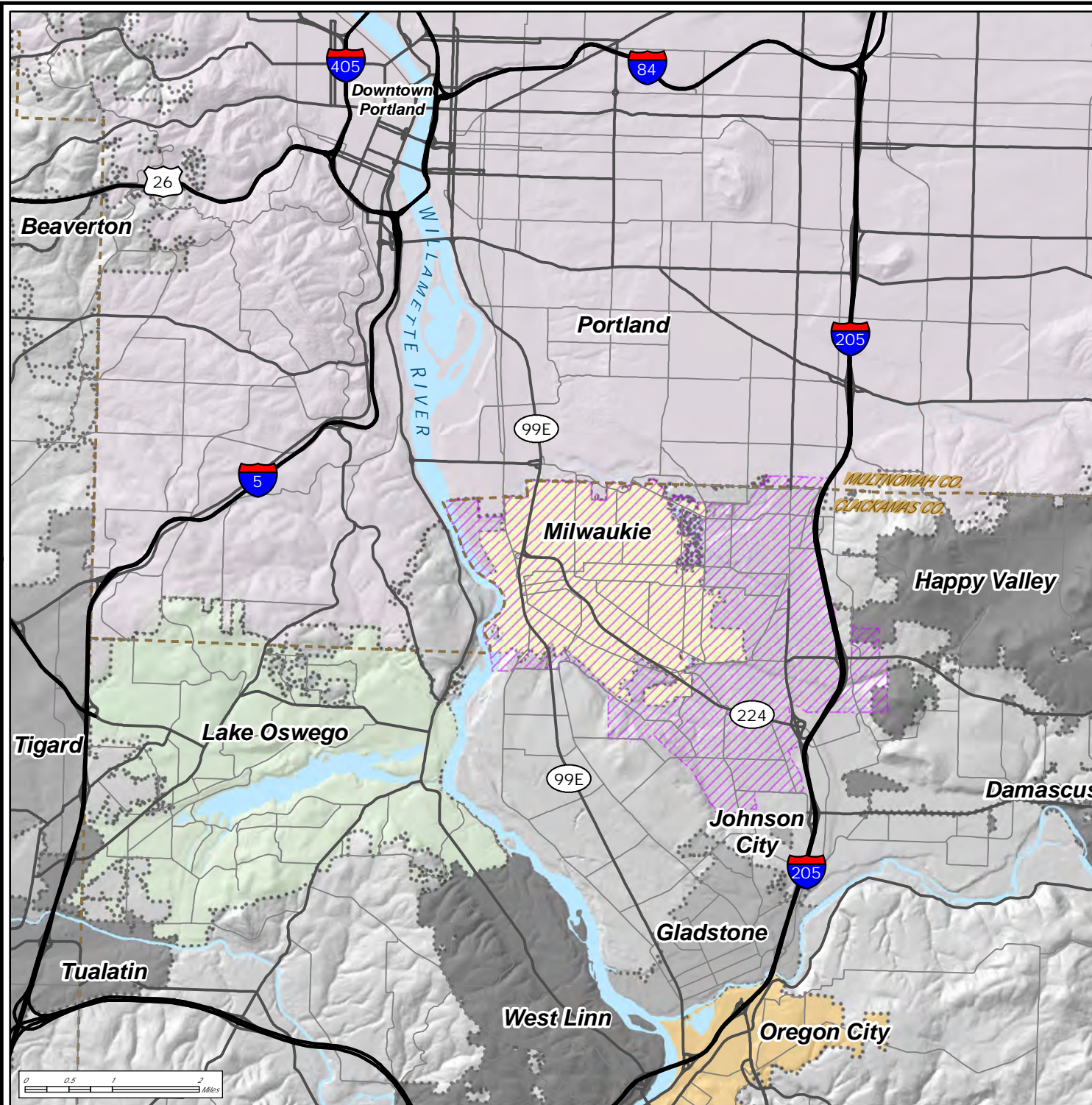


STUDY AREA CONTEXT

November 2013

LEGEND

-  Milwaukie City Limits
-  Urban Growth Management Agreement (UGMA) area
-  Freeways
-  Major Arterials
-  Arterials
-  County Line
-  Water
-  City Limits





Transportation System Plan

FIGURE 3-1b

STUDY AREA

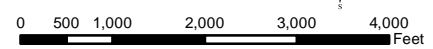
November 2013

LEGEND

- Study Intersections
- Major Highways
- Major Roads
- Streets
- Kellogg Creek Trail
- Springwater Trail
- Trolley Trail
- Light Rail Station
- Light Rail Transit
- Railroad
- Schools
- County Line
- Town Center
- Water
- Parks
- City Limits



DKS Associates
TRANSPORTATION SOLUTIONS



The following sections describe the City's existing transportation facilities and their usage and performance.

PEDESTRIANS

The Metro Regional Transportation Plan (RTP) identifies downtown Milwaukie as a Town Center; a local activity area that provides a range of local retail and service opportunities within close proximity to each other. Milwaukie's downtown is characterized by a variety of small specialty retail shops, storefront businesses, and a historic street grid network. There are three parks within downtown and five schools within the Town Center boundary. These features are important hubs of pedestrian activity.

Existing Pedestrian Facilities

All of the sidewalks and trails within Milwaukie are displayed in Figure 3-2. Many sections of the City's arterial and collector streets, identified as Major Roads on Figure 3-2, have sidewalks on at least one side of the street. A typical sidewalk configuration is a "curb tight" design, where the sidewalk is constructed adjacent to the curb.

In general, neighborhoods to the northeast of Hwy 224 lack adequate pedestrian facilities. For example many older residential areas in this part of the city have no sidewalks whatsoever whereas most of the streets in downtown and residential areas to the southwest of Hwy 224 have sidewalks on both sides. This patchwork of sidewalks is well illustrated in Figure 3-2, which shows the existing sidewalks and areas lacking.

Based on a visual inspection, many of the sidewalks in Milwaukie are in good to excellent condition, with no major cracking or heaving. Examples of sidewalks in very good or excellent condition are 37th Ave near Milwaukie Marketplace and along McLoughlin Blvd near downtown. Almost all sidewalks are located in the public right-of-way, yet in Milwaukie it is the responsibility of the adjacent property owner to repair sidewalks in poor condition.

Sidewalks are rarely free of obstructions, and Milwaukie sidewalks are no exception. In addition to the occasional utility pole, many Milwaukie residents share their sidewalks with mailboxes. This is more of a concern where older, narrower sidewalks exist; for instance, the western portion of Lake Rd, where the sidewalk is narrow and made of asphalt.

In Milwaukie, wheelchair ramps are not provided at every intersection with sidewalks. However, since the Americans with Disabilities Act (ADA) was enacted in 1991, the City has required and installed wheelchair ramps in all sidewalk projects. Over the past few years, the City has retrofitted numerous intersections in the downtown area with wheelchair ramps. There are still a number of intersections that have partial or no ramps and need to be retrofitted.

Pedestrian crosswalks exist primarily at signalized intersections and crossings. Most of these intersections have crosswalks on all four legs, but there are a few where crosswalks are only partially provided.

The Springwater Trail, a regional multiuse path, extends east from Ochoco St, and continues along Johnson Creek Blvd to Linwood Ave, where it extends beyond the city limits to the east. East of 45th Ave, this trail serves as a pedestrian facility for Johnson Creek Blvd, as there are no sidewalks on this stretch of road. The Three Bridges Project, which constructed bridges across the Union Pacific Railroad, McLoughlin Blvd, and Johnson Creek, has extended the Springwater Trail westward to the intersection of 19th St/Ochoco St. This trail is nearly continuous and connects Portland to Milwaukie. However, there is limited access to the trail between 45th Ave and Ochoco St due to grade separation of the trail and the streets it crosses.



Transportation System Plan

FIGURE 3-2

SIDEWALK INVENTORY

November 2013

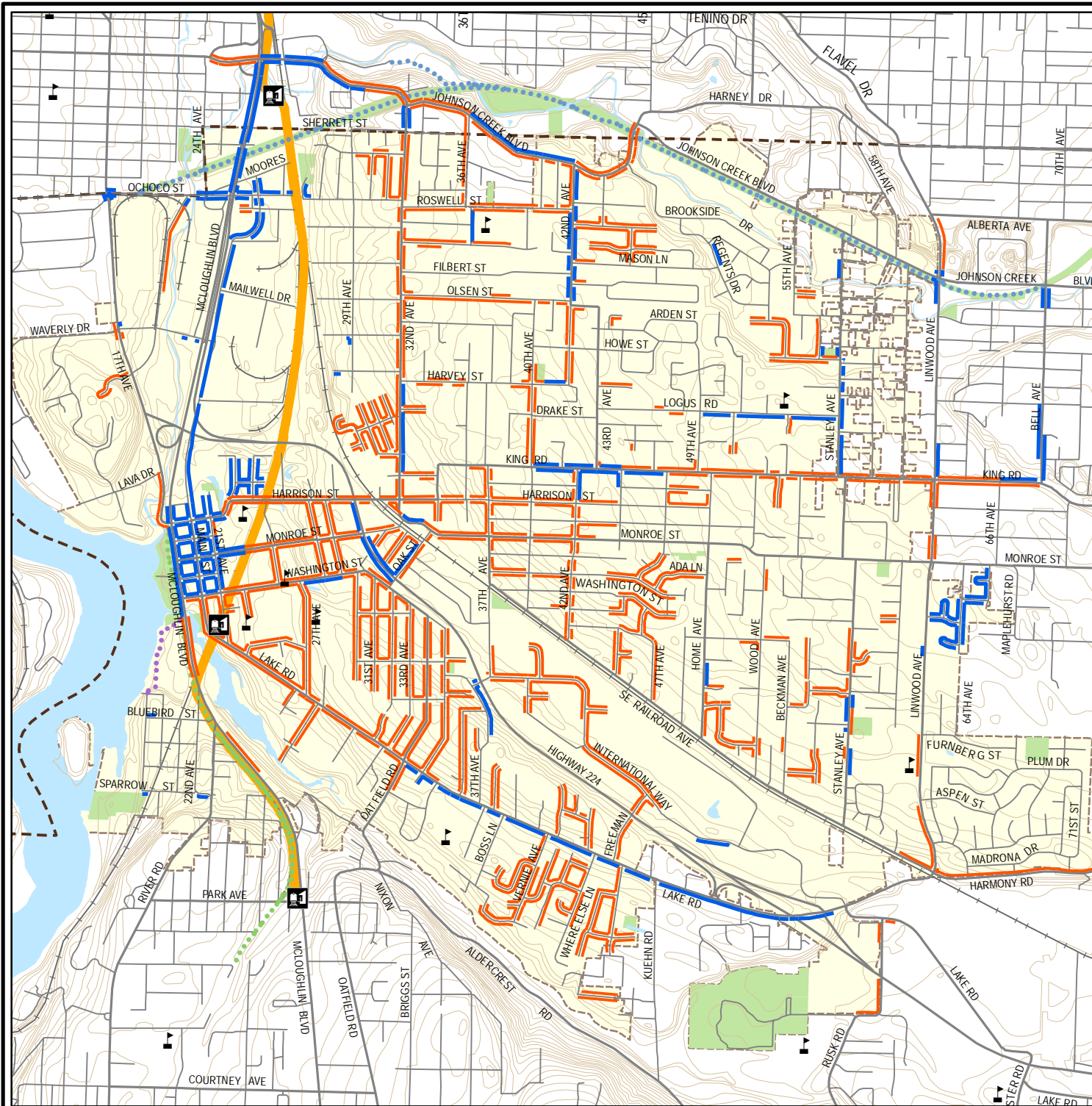
LEGEND

Sidewalks

- < 5 ft width
- 5 ft - 10 ft width

Other Map Features

- Schools
- ⋯ Kellogg Creek Trail
- ⋯ Springwater Trail
- ⋯ Trolley Trail
- Light Rail Station
- Light Rail Transit
- Major Roads
- Streets
- Railroad
- - - County Line
- 10' Contours
- Water
- Parks
- City Limits



DKS Associates
TRANSPORTATION SOLUTIONS



0 500 1,000 2,000 3,000 4,000 Feet

The Kellogg Creek Trail, a regional multiuse path, is recognized by Metro as being part of the North Clackamas Greenway. The trail is 7.5 feet wide and runs along the Willamette River from Adams St to Eagle St, connecting downtown Milwaukie with the Island Station neighborhood. This trail serves as an alternative multiuse path along McLoughlin Blvd and the riverfront.

Another trail that is partially constructed is the Trolley Trail. This multiuse trail starts in downtown Milwaukie and extends south to Gladstone. The Trolley Trail provides an aesthetically pleasing and safe connection between neighborhoods, parks, schools, retirement communities, businesses, and public transit. A segment of the trail along McLoughlin Ave between Park Ave and River Rd is closed until 2014 due to construction of the Portland-Milwaukie Light Rail (PMLR).

Pedestrian Volume

Pedestrian crossing volumes were counted at the study intersections during the summer of 2006, and are shown in Figure 3-3a and Figure 3-3b. The counts were taken during the evening peak period (4:00 to 6:00 p.m.) at the study intersections, and represent a snapshot in time of pedestrian travel.

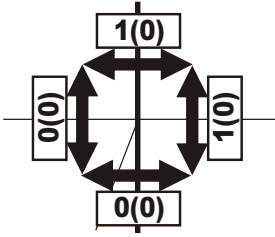
The most significant pedestrian movements occur near retail and educational areas, including downtown Milwaukie, the intersection of Linwood Ave and King Rd, and the intersection of Johnson Creek Blvd and Linwood Ave. Along major roadways, such as McLoughlin Blvd and Hwy 224, pedestrian crossings are limited to locations with traffic signal controls, due to high motor vehicle volumes and speeds.

Summary of Pedestrian Findings

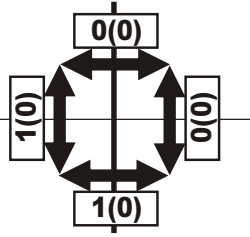
The following summarizes key pedestrian findings related to the level of activity documented as well as deficiencies for this mode of travel. These findings will be utilized to help guide future improvements to address the deficiencies for this mode of travel in the transportation network.

- The majority of study area intersections have pedestrian activity levels on individual legs of the intersections that are ten crossings or less during the p.m. peak hour. Locations with higher activity levels than this occur along the Springwater Trail and in downtown.
- There are a number of discontinuous sidewalks within Milwaukie that prohibit the ease of use for pedestrians to travel in and around the city. These occur primarily in the east and north areas of the city.
- The city contains numerous dead-end and curvilinear streets that hamper pedestrian connectivity.
- Travel between the eastern and western areas of the city is particularly problematic due to the location of Hwy 224 and the railroad line that parallels it to the north. Both of these transportation facilities act as barriers to pedestrian travel because there are few places where these facilities can be crossed. The roadway width and average vehicle speed on Hwy 224 also contribute to this barrier effect.
- The use of asphalt at the city's railroad crossings is also of concern to pedestrians because it is more prone to buckling than concrete. The city has numerous at-grade railroad crossings, and the condition at these crossings varies widely. Those crossings with uneven walking surfaces are of special concern to elderly and disabled individuals.

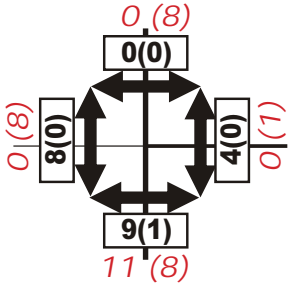
1 SE McLoughlin Blvd @ SE Ochoco St



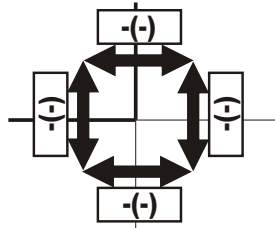
2 SE McLoughlin Blvd @ SE Milport Rd



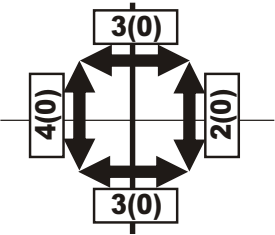
3 SE McLoughlin Blvd @ SE Harrison St/17th Av



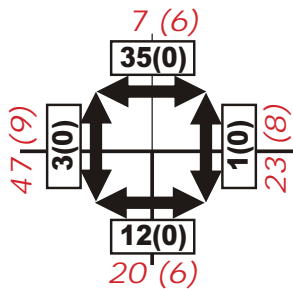
4 SE 42nd Av @ SE Harrison St



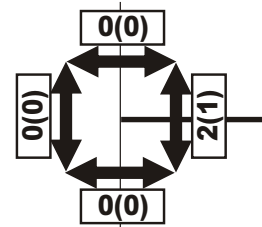
5 SE McLoughlin Blvd @ SE Washington St



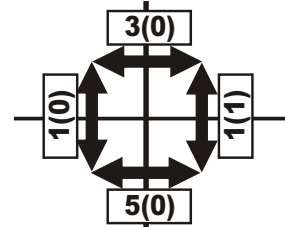
6 SE Harrison St @ SE Main St



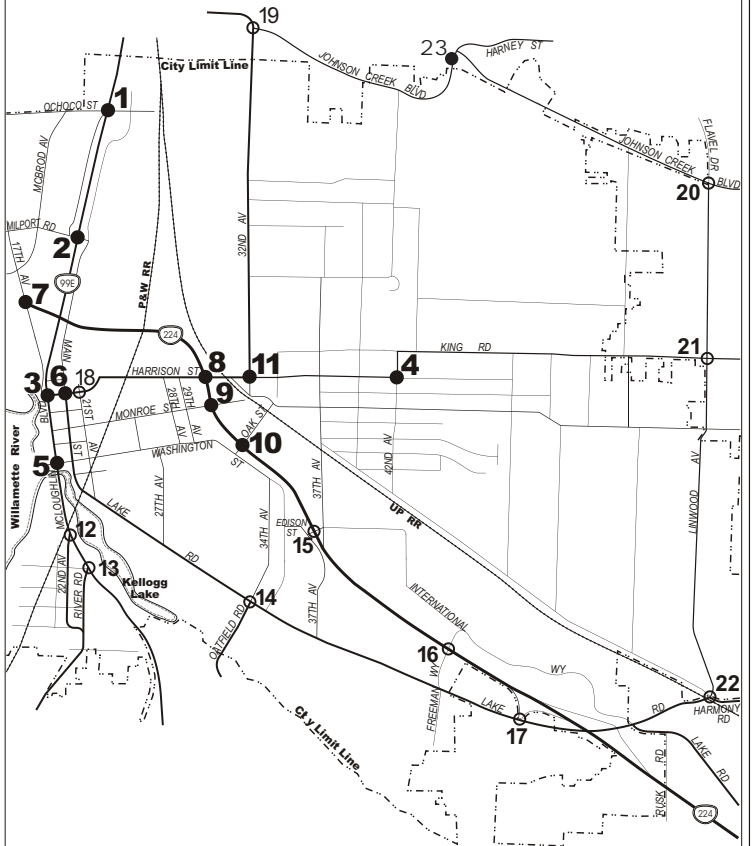
7 Hwy 224 @ SE 17th Av



8 Hwy 224 @ SE Harrison St

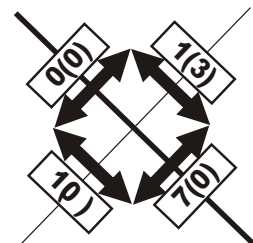


Transportation System Plan
MILWAUKIE

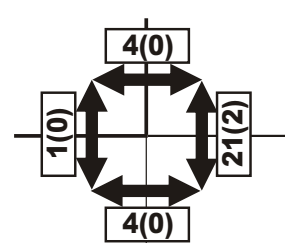


September 2007

10 Hwy 224 @ SE 32nd Av



11 SE Harrison St @ SE 32nd Av



LEGEND

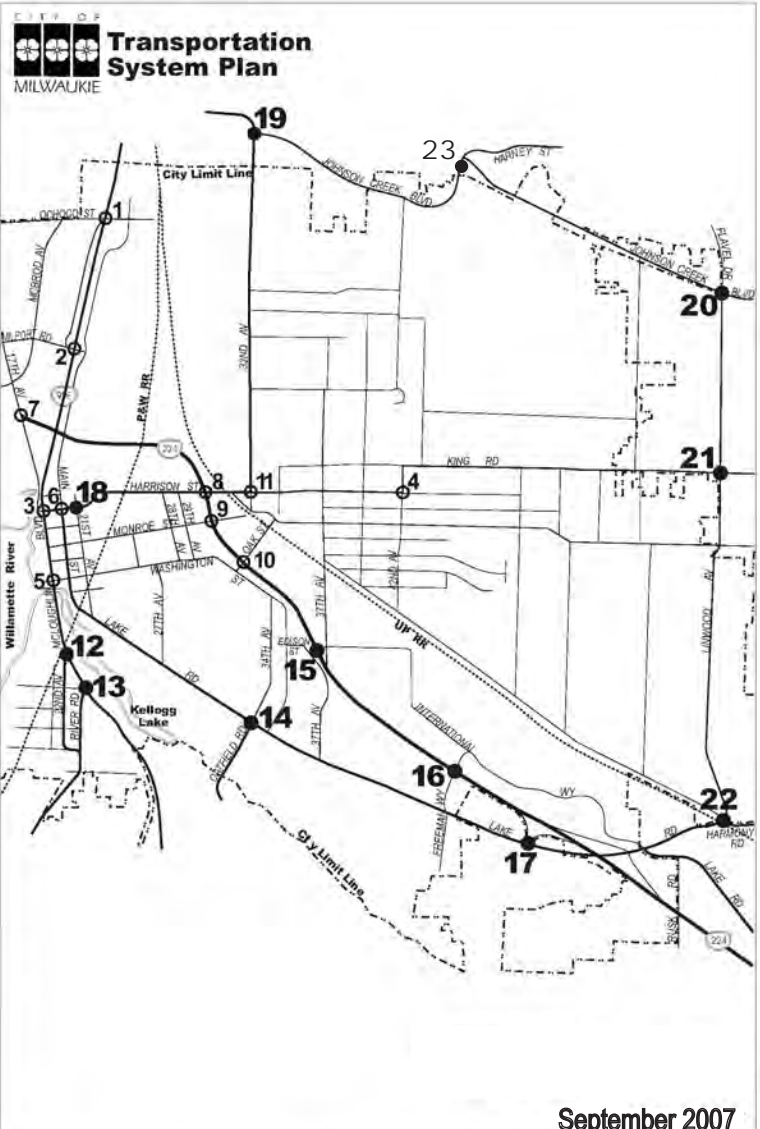
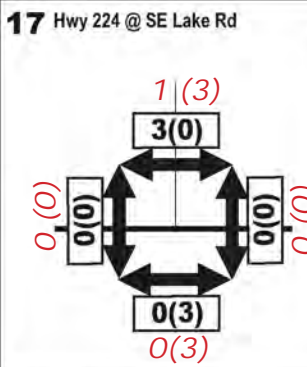
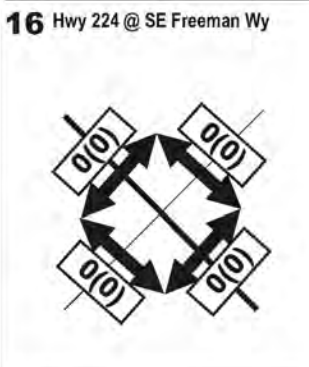
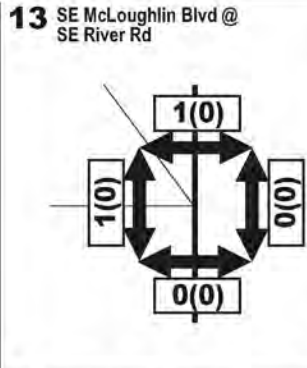
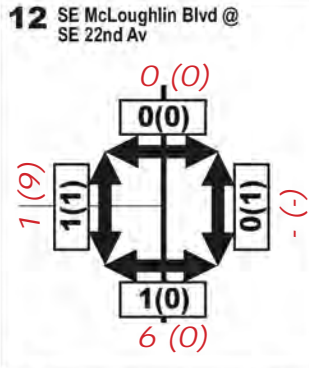
- X●** - Study Intersection & Number (This Sheet)
- X○** - Study Intersection & Number (Next Sheet)
- P(B)** - Pedestrian(Bicycle) Volume (Fall 2006)
- ↔** - Indicates No Available Data
- (-)** - Pedestrian (Bicycle) Volume (Summer 2007)

DKS Associates
TRANSPORTATION SOLUTIONS

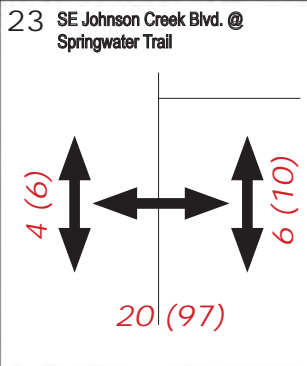
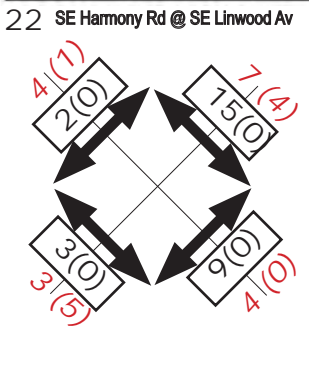
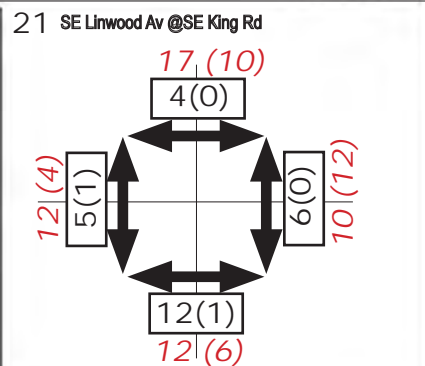
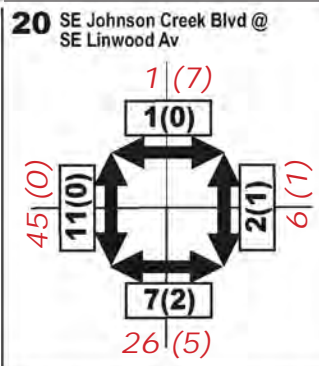
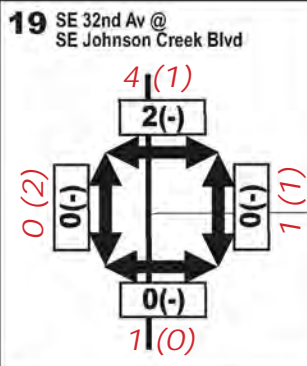
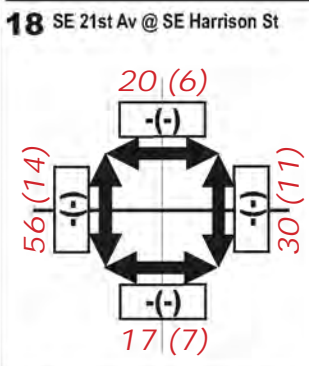


Figure 3-3a

EXISTING PEDESTRIAN & BICYCLE PM PEAK HOUR VOLUMES



September 2007



LEGEND
 X● - Study Intersection & Number (This Sheet)
 XO - Study Intersection & Number (Previous Sheet)
 P(B) - Pedestrian(Bicycle) Volume (Fall 2006)
 (-) - Indicates No Available Data
 - Pedestrian (Bicycle) Volume (Summer 2007)

BICYCLES

In general, designated bicycle facilities are limited in Milwaukie, making it difficult for bicyclists to safely and easily access activity centers and other local and regional destinations. The State Transportation Planning Rule requires cities to provide bikeways along roads classified as arterials and major collectors.¹ Figure 3-4 shows the existing designated bicycle facilities in Milwaukie.

Existing Bicycle Facilities

There are a limited number of designated bikeways and bicycle facilities in Milwaukie. A bikeway can include any road that is designed to accommodate bicycles.² Bikeways may have wider lanes or shoulders, and can be marked by pavement markings and signage. On-road bikeways generally exist on arterial and collector streets and can consist of a delineated bike lane or a wide shoulder (six feet or more). However, in Milwaukie, bikeways do not exist on all arterial or collector streets. Typically, north-south bikeways are discontinuous, except for Linwood Ave. In general, bikeways exist on the edges of the city lack connectivity. Metro's Regional Transportation Plan (RTP) identifies Hwy 224 and parts of McLoughlin Blvd as regional on-street bikeways, although the lack of marked bike lanes and higher traffic volumes and speeds along these corridors may discourage use by bicyclists. There are no bicycle detectors at signalized intersections or bikeway signage on the streets.

There are three off-road multiuse trails that enhance bicycle access in Milwaukie. First is the Springwater Trail, which parallels Johnson Creek Blvd in Milwaukie, and connects bicyclists to downtown Portland to the northwest and to the I-205 north-south multiuse trail to the east. Due to grade separation, there is limited access to the trail in some locations. Another off-street facility available in Milwaukie is the Kellogg Creek Trail in the downtown riverfront area, which is part of the North Clackamas Greenway. Bicyclists also have access to a portion of the Trolley Trail where construction was recently completed in downtown Milwaukie. The Trolley Trail runs along an old streetcar route that begins in Riverfront Park in downtown Milwaukie and ends in Gladstone to the south. A segment of the trail along McLoughlin Blvd between River Rd and Park Ave is closed until 2014 due to construction of PMLR.

Based on a general visual survey, the surface conditions of bikeways are generally good to excellent with the exception of King Rd, where the bike and auto lanes suffer due to failing pavement conditions.

Bicycle Volume

Bicycle counts were conducted in Fall 2006 during the evening peak period (4:00 to 6:00 p.m.) at the study intersections shown in Figures 3-3a and 3-3b. At some locations, additional counts were taken in August 2007. These counts are shown in red on Figures 3-3a and 3-3b. The reported bicycle volumes are generally moderate, with the highest level of activity in the downtown area.

¹ (OAR 660-012-0020) Department of Land Conservation and Development, Division 12, Transportation Planning Rule.

² Oregon Bicycle and Pedestrian Plan, Oregon Department of Transportation, June 14, 1995.



Transportation System Plan

FIGURE 3-4

BICYCLE FACILITY INVENTORY

November 2013

LEGEND

Bicycle Lanes

Shared Lane

Bicycle Lane

Trails

Kellogg Creek Trail

Springwater Trail

Trolley Trail

Other Map Features

Schools

Railroad



Light Rail Station

Light Rail Transit

Water

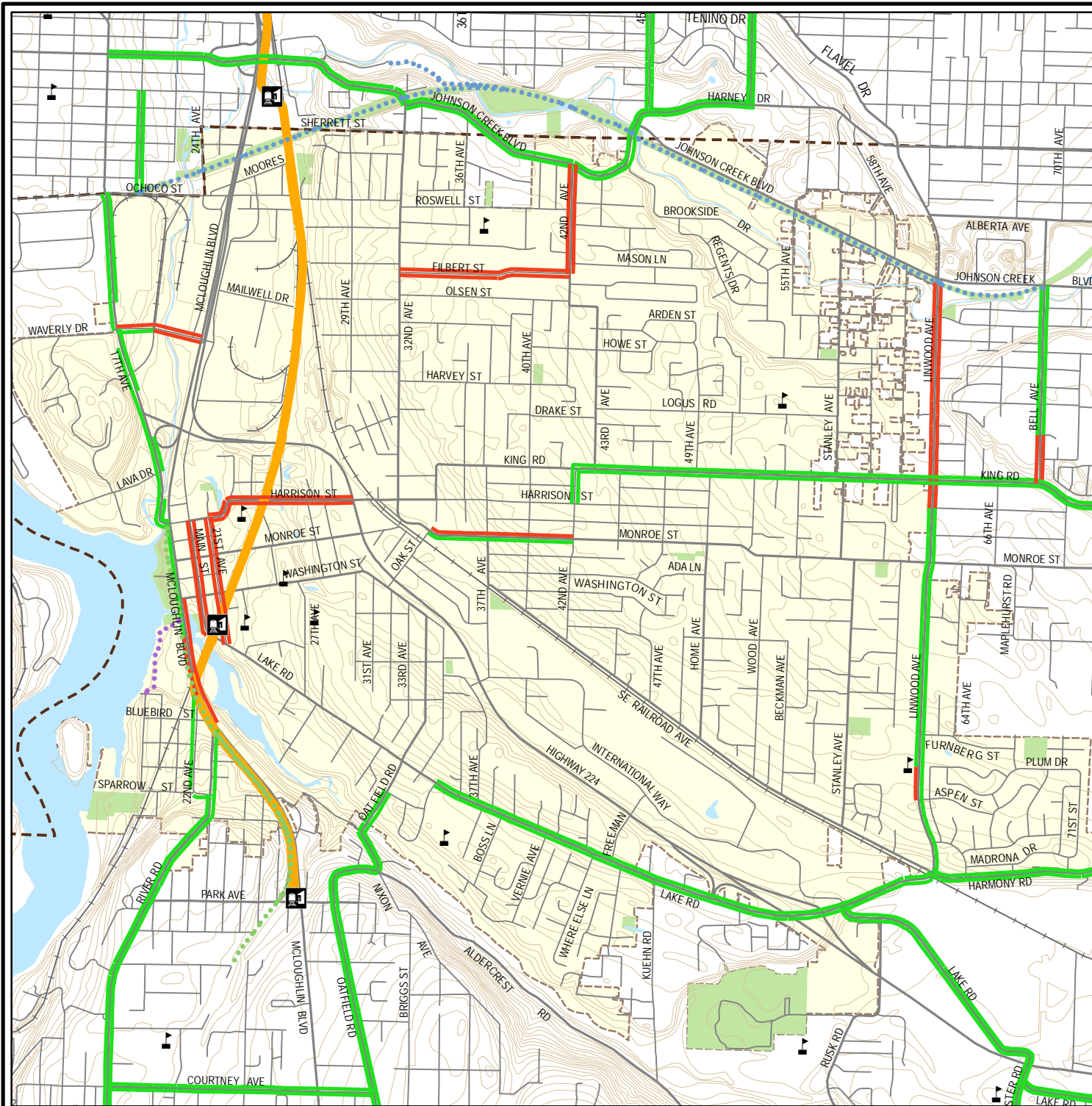
Major Roads

Parks

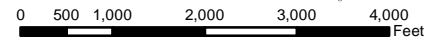
Streets

City Limits

10' Contours



DKS Associates
TRANSPORTATION SOLUTIONS



Summary of Bicycle Findings

The following summarizes key bicycle findings related to the level of activity documented as well as deficiencies for this mode of travel. These findings will be utilized to help guide future improvements to address the deficiencies for this mode of travel in the transportation network.

- In general, designated bikeways exist on the edges of the city and lack connectivity through the city.
- The Springwater Trail along the northern edge of the city is a valuable off-road bikeway; however, it is currently difficult to access west of 45th Ave.
- Bicyclists traveling between the eastern and western areas of the city are impeded by the location of Hwy 224 and the railroad line that parallels it to the north. Both of these transportation facilities act as barriers to bicycle travel because there are few places where these facilities can be crossed. The roadway width and average vehicle speed on Hwy 224 also contribute to this barrier effect.

PUBLIC TRANSIT

Fixed-route, dial-a-ride and paratransit services are available within Milwaukie for both local and regional trips. Two agencies, Clackamas County and the Tri-County Metropolitan District of Oregon Transit (TriMet), provide these services. TriMet provides transit service to and from Milwaukie, with fixed-route transit services including routes 28, 29, 31, 32, 33, 34, 70, 75, 99, and 152. These routes, their approximate headways, the locations of stops, shelters, the transit center, and park-and-rides are shown in Figure 3-5. This map also shows Neighborhood District Association boundaries to provide additional context for the location of existing transit facilities.

Table 3-1, below, shows each bus route's schedule, approximate headway, and main destinations.³ Most of the bus lines serving the city operate with average headways of 30 minutes or less (three have 15 minute headways) during the peak weekday commute hours. Bus service is limited on the weekends. When in service, the bus routes listed above transport riders to several local and regional destinations, including downtown Milwaukie, Clackamas Town Center, downtown Portland, Oregon City, Clackamas Transit Center, Milwaukie Providence Hospital, Lloyd Center, Clackamas Community College, and the Milwaukie Center.

Table 3-1 Service Route Schedules and Destinations

Existing Public Transit Service in Milwaukie					
Line # and Name	Weekday		Weekend		Destinations Served (partial list)
	Schedule	Approx. Headway (min.)	Schedule	Approx. Headway (min.)	
28 Linwood	6:00 a.m.-7:00 p.m. Peak and Off-peak	60	No Service	N/A	Milwaukie Transit Center Clackamas Town Center
29 Lake/ Webster	6:30 a.m.-8:00 p.m. Peak and Off-peak	60	No Service	N/A	Milwaukie Transit Center Clackamas Town Center
31 King Rd	6:00 a.m.-10:00 p.m. Peak Off-peak	30 60	Sat: 6:30 a.m.-10:00 p.m. Peak Off-peak	30 60	Milwaukie Transit Center Clack. Town Ctr. Transit Center Downtown Portland
32 Oatfield	7:00 a.m.-7:30 p.m. Peak Off-peak	30 60	Sat: 9:30a.m.-5:30 p.m. Peak and Off-peak	60	Milwaukie Transit Center Clackamas Comm. College Downtown Portland Oregon City Transit Center
33 McLoughlin	4:30 a.m.-2:00 a.m. Peak Off-peak	15 30	Sat & Sun: 5:30 a.m.-1:30 a.m. Peak Off-peak	15 30	Clackamas Comm. College Downtown Portland Oregon City Transit Center Milwaukie Transit Center
34 River Rd	5:30 a.m.-8:00 p.m. Peak and Off-peak	60	No Service	N/A	Oregon City Transit Center Milwaukie Transit Center
70 12 th Ave	5:00 a.m.-11:00 p.m. Peak Off-peak	15 30	Sat & Sun: 8:30 a.m.-11:00 p.m. Peak Off-peak	15 60	Milwaukie Transit Center Lloyd Center Columbia River Correction Center

³ A headway is the amount of time between bus arrivals.

Existing Public Transit Service in Milwaukie					
Line # and Name	Weekday		Weekend		Destinations Served (partial list)
	Schedule	Approx. Headway (min.)	Schedule	Approx. Headway (min.)	
75 Cesar Chavez (39 th Ave)/Lombard	4:30 a.m.-1:30 a.m. Peak Off-peak	15 30	Sat & Sun: 5:30 a.m.-1:30 a.m. Peak Off-peak	15 30	Milwaukie Transit Center Milwaukie Providence Hospital St. Johns
99 McLoughlin Express	Peak only	20	No Service	N/A	Clackamas Comm. College Downtown Portland
152 Milwaukie Shuttle	6:30 a.m.-6:30 p.m. Peak Off-peak	30 60	No Service	N/A	Milwaukie Transit Center Clackamas Town Center Milwaukie Center

Milwaukie is divided into seven officially recognized Neighborhood District Associations (NDAs) and two business and industrial centers, each with varying levels of transit coverage. Table 3-2 summarizes the transit service and amenities available in the different neighborhoods. All of the neighborhoods in Milwaukie have access to transit, with some neighborhoods having more service than others. Research has shown that a transit rider will walk up to 1/4 mile to a transit stop.⁴ Figure 3-5 illustrates existing transit facilities.

Table 3-2 Neighborhood Service Routes and Public Transit Amenities

Neighborhood	Transit Route #'s	Stops	Facilities
Ardenwald	31, 75, 28	39	2 Shelters
Hector Campbell	31	12	No Extra Facilities
Historic Milwaukie	29, 31, 32, 33, 34, 70, 75, 99, 28, 152	36	1 Transit Center with Shelters 1 park-and-ride
Island Station	33, 34, 99	13	No Extra Facilities
Lake Rd	29, 32	30	No Extra Facilities
Lewelling	28, 31, 75	30	No Extra Facilities
Linwood	28, 31	26	No Extra Facilities
McLoughlin Industrial	31, 32, 33, 99	17	3 Shelters
Milwaukie Business & Industrial	31, 152	22	No Extra Facilities

Milwaukie's bus transit center is located in downtown Milwaukie on the blocks surrounding City Hall. In addition to the transit center, a single shared-use park-and-ride is located along Lake Rd south of downtown. TriMet has plans to construct a second park-and-ride facility on Main St at the former Southgate Theater site. Currently there are only six shelters provided within Milwaukie. TriMet typically considers locating transit shelters at stops with 35 or more boardings

⁴ Planning Commission TOD Committee, Walking Distance Research, http://www.fairfaxcounty.gov/planning/tod_docs/walking_distance_abstracts.pdf, Fairfax County, Virginia.



Transportation System Plan

FIGURE 3-5

TRANSIT ROUTES AND SHELTERS

November 2013

LEGEND

Transit Facilities

Bus Routes
< 30 Min. Frequency

Bus Routes
> 30 Min. Frequency

TC Transit Center

● Stop

● Shelter

P Park-and-Ride

Light Rail Station

Light Rail Transit

Other Map Features

Schools

Kellogg Creek Trail

Springwater Trail

Trolley Trail

Water

Parks

Major Roads

Streets

Railroad

County Line

City Limits

Neighborhood District Associations

ARDENWALD

HECTOR CAMPBELL

HISTORIC MILWAUKIE

ISLAND STATION

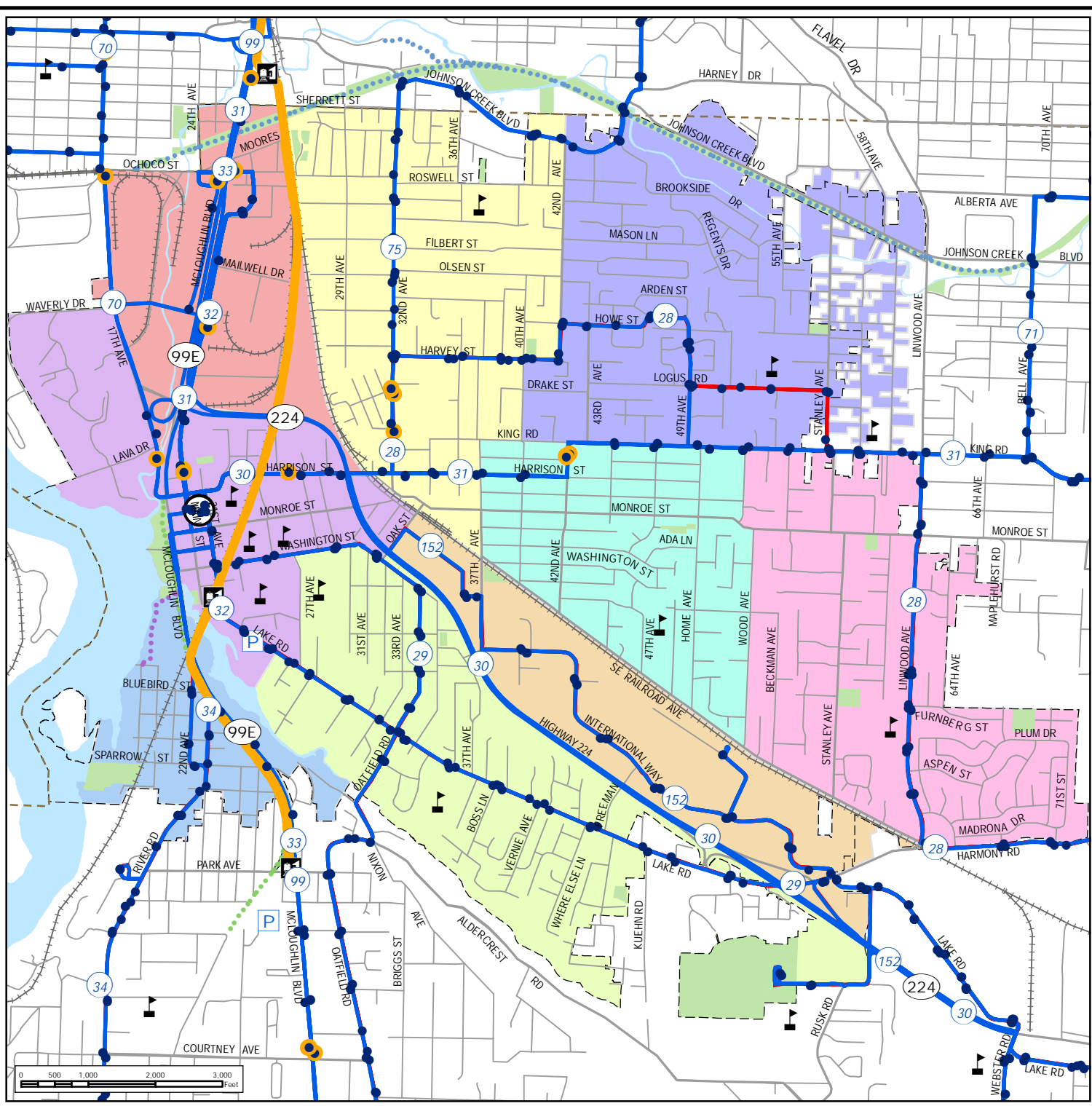
LAKE ROAD

LEWELLING

LINWOOD

MCLOUGHLIN INDUSTRIAL

MILWAUKIE BUSINESS INDUSTRIAL



DKS Associates
TRANSPORTATION SOLUTIONS

per day.⁵ One stop meets this minimum boarding threshold, but does not offer a shelter.⁶ This stop is located near the intersection of Harrison St and 24th Ave.

Transit service quality, or its Level of Service (LOS), is measured as the headway between arriving buses. Headway is the average amount of time that a person could expect to wait to catch a bus. For instance, a transit service with a low headway (<10 min) provides a high LOS ("A"), because vehicles are arriving frequently (approximately 1 vehicle every 10 minutes). The average headways and corresponding LOS (based on the *Highway Capacity Manual* methodology⁷) for each of the routes serving Milwaukie are listed in Table 3-3.

Table 3-3 TriMet Service Routes and Weekday Peak Period Level of Service

Line # and Name	Average Headway (minutes)			Level of Service (LOS) (based on headways)		
	a.m.	Midday	p.m.	a.m.	Midday	p.m.
28 Linwood	62	71	75	F	F	F
29 Lake/Webster Rd	62	71	76	F	F	F
31 King Rd	28	28	29	D	D	D
32 Oatfield	36	58	30	E	E	E
33 McLoughlin	18	20	18	C	D	C
34 River Rd	70	72	70	F	F	F
70 12 th /NE 33 rd Ave	18	19	17	C	C	C
75 Cesar Chavez/Lombard	14	17	13	B	C	B
99 McLoughlin Express	26	*	21	D	*	D
152 Milwaukie	36	69	27	E	F	D

Note: a.m. period = 06:00-08:30, Midday period = 08:30-16:00, p.m. period = 16:00-18:00

Level of Service (LOS) for transit service based on headway:

- **LOS A** = less than 10 minutes
- **LOS B** = 10-14 minutes
- **LOS C** = 14-19 minutes
- **LOS D** = 20-29 minutes
- **LOS E** = 30-60 minutes
- **LOS F** = greater than 60 minutes

*No service.

Special Transit Services

Special transit services are available to residents of Milwaukie through the Milwaukie Center Transportation Program, and TriMet Lift Program. The Milwaukie Center Transportation Program is part of the Clackamas County Transportation Consortium, which is dedicated to providing coordinated transportation services to seniors and ADA-eligible persons. Transit opportunities are also available to the residents of Hillside Manor and Hillside Park, a low-income housing area located near the corner of Hillside Court and 32nd Ave. The Milwaukie Center, located within North Clackamas Park, is a community center that offers different social services and a place for social gatherings. The different transit programs available through the Milwaukie Center include:

- **The Dial-a-Ride program**, which offers rides to service area residents who are over age 60 or disabled. The service offered is available within the city of Milwaukie and its urban growth boundary, and runs between locations, such as the Milwaukie Center, shopping locations, and the residents' homes.

⁵ *Design Criteria*, TriMet, August 2002.

⁶ Based on Fall 2006 weekday bus boarding information as provided by TriMet.

⁷ *2000 Highway Capacity Manual*, Transportation Research Board, 2000, Chapter 27.

- **The Transportation Reaching People (TRP) program**, which is a volunteer service available to seniors and people with disabilities, and consists of drivers from Clackamas County Volunteer Connection. It takes people to their appointments on a donation basis.
- **The Catch-a-Ride program**, which offers similar services to residents of Hillside Manor, Hillside Park, and other Milwaukie area residents. It serves a number of different locations within the city, including the Milwaukie Transit Center and Clackamas Town Center.

TriMet, the primary public transportation provider in the region, has a special transit program available to Milwaukie residents:

- **The TriMet Lift program**, which provides small bus transportation services that are equipped to handle persons with disabilities. Those eligible for program services have physical or mental disabilities that prevent their use of fixed-route transit service (as required by the Americans with Disabilities Act). This service is available seven days per week and the TriMet service area is a 0.75-mile radius around existing bus routes. Eligible users are to call in advance to schedule for Lift Program pick-up.

Summary of Public Transit Findings

The following summarizes key transit findings related to the level of activity and deficiencies documented for this mode of travel. These findings will be utilized to help guide how future improvements can address the deficiencies for this mode of travel.

- The majority of Milwaukie is served by some form of transit that is accessible within 1/4 mile of transit stops provided by TriMet, with the exception of an area to the east bounded by Railroad Ave to the south, 42nd Ave to the west, Monroe St to the north and Stanley Ave to the east. The existing railroad line that parallels Hwy 224 in this area restricts transit accessibility to the south for this area, and existing transit routes that run along Linwood Ave and King Rd are beyond the 1/4-mile radius that a pedestrian would typically travel to access transit. A second area in the northeast corner of Milwaukie, roughly centered on Johnson Creek Blvd and 55th Ave, lacks adequate transit service. This area includes many of the properties that recently annexed into the city.
- In total, approximately 15% of land coverage in Milwaukie does not have access to transit within 1/4 mile of existing transit stops, with approximately half of that lacking coverage occurring in the area identified above.
- Generally, Milwaukie is served with headways (time between buses) along existing transit routes of 30 minutes or better. However, some roadways have headways longer than 30 minutes. These facilities are: Lake Rd, Oatfield Rd, Linwood Ave, International Way, and Harvey St/Logus Rd.
- There are currently six transit stops that have shelters. Two additional stops have existing ridership that meet TriMet's standard for placing shelters:
 - Harrison St/24th Ave
 - 42nd Ave/Llewellyn St

MOTOR VEHICLES

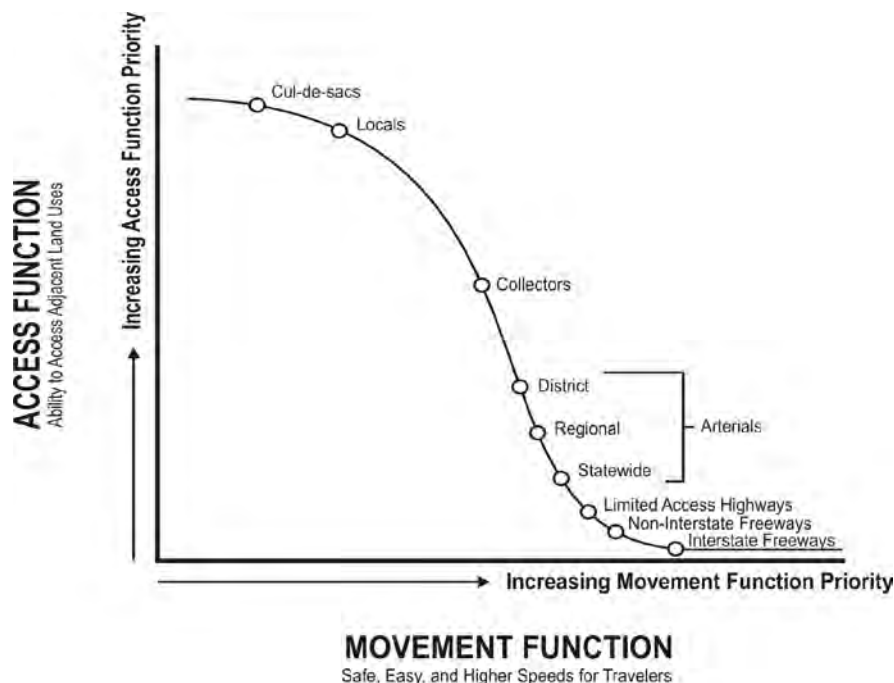
The following section addresses all aspects of the motor vehicle network throughout Milwaukee. The topics addressed include:

- Roadway functional classification
- Roadway characteristics
- Motor vehicle volume
- Measures of effectiveness
- Safety
- Heavy vehicles

Roadway Functional Classification

The functional classification system is designed to serve transportation needs within the community. The schematic diagram below illustrates the competing functional nature of a roadway facility as it relates to access, mobility, multimodal transport, and facility design. The diagram is useful for understanding how worthwhile objectives can have opposing effects. For example, as mobility is increased (bottom axis), the provision for nonmotor vehicle modes is decreased accordingly. Similarly, as access increases (left axis), the facility design dictates slower speeds, narrower travel-ways, and nonexclusive facilities. The goal of selecting functional classes for particular roadways is to provide a suitable balance of these two competing objectives.

Figure 3-6: Functionality of Access versus Movement



The diagram above shows that as street classifications progress from local, to collector, to arterial, to freeway (top left corner to bottom right corner) the following occurs:

- **Mobility Increases:** As the level of mobility increases, the distance between destinations as well as the proportions of freight and through traffic generally increases.

- **Integration of Pedestrian and Bicycle Facilities Decreases:** Provisions for adjoining sidewalks and bike facilities are required up through the arterial class; however, the frequency of intersection or midblock crossings for nonmotorized vehicles steadily decreases with higher functional classes. Expressway and freeway facilities typically do not allow pedestrian and bike facilities adjacent to the roadway, and any crossings are grade-separated to enhance mobility and safety.
- **Access Decreases:** As mobility increases, access to parking, loading, and land are reduced.
- **Facility Design Standards Increase:** Roadway design standards increase in technical complexity to accommodate wider and faster facilities for exclusive use by motor vehicles. The opposite end of the scale is the most basic two-lane roadway with unpaved shoulders that requires minimal technical design.

The existing Milwaukie functional class system for roadway facilities is shown in Figure 3-7. A street-by-street comparison to ODOT, Metro and the City of Milwaukie classifications for arterial and collector streets is shown in Table 3-4. Additionally, Table 3-4 compares the right-of-way (ROW) width to the actual pavement width for each facility.



Transportation System Plan

FIGURE 3-7

FUNCTIONAL CLASSIFICATION

November 2013

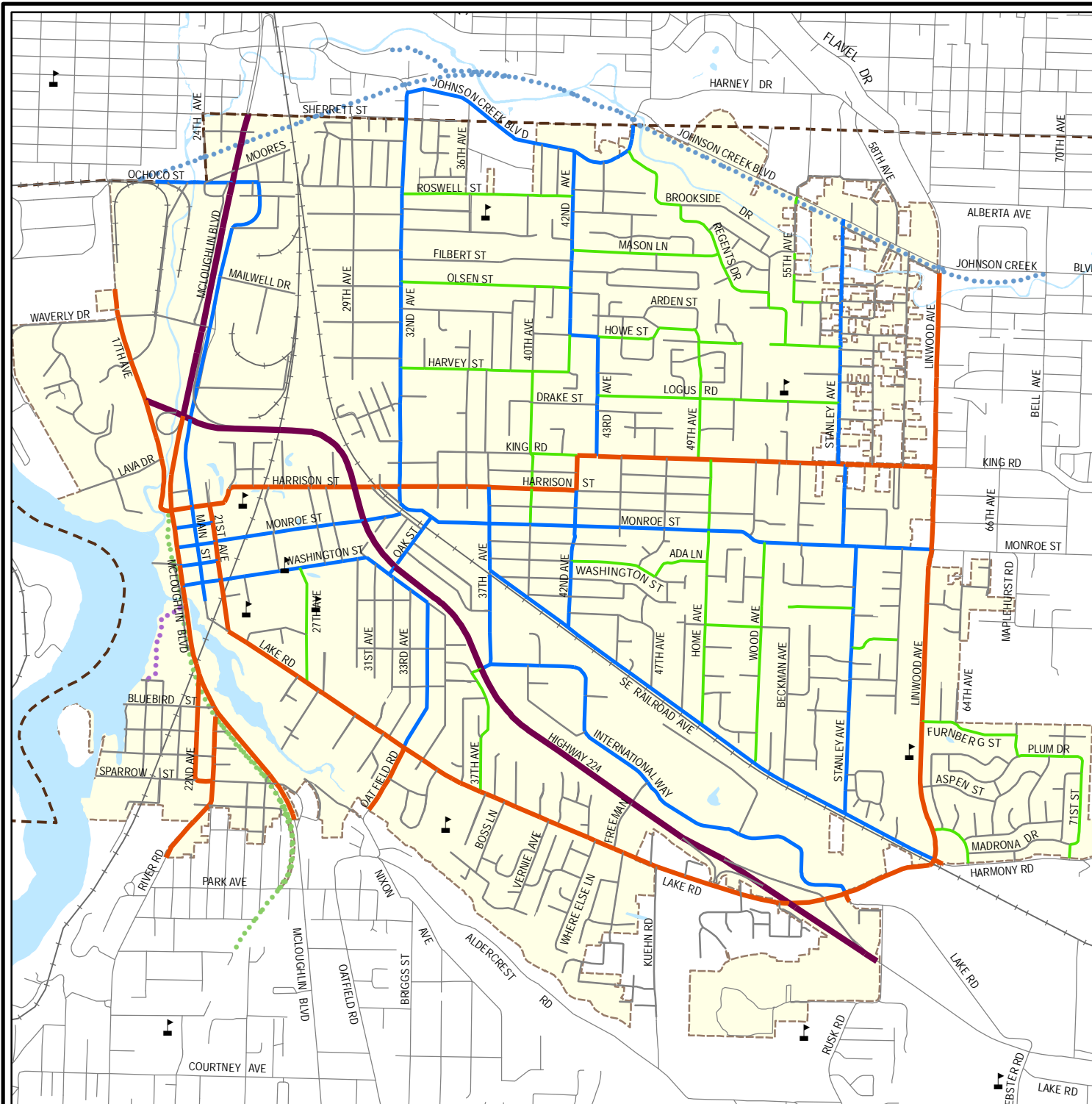
LEGEND

Functional Classification

- Regional Routes
- Arterials
- Collectors
- Neighborhood Routes
- Local

Other Map Features

- Schools
- Kellogg Creek Trail
- Springwater Trail
- Trolley Trail
- Railroad
- County Line
- Water
- City Limits



DKS Associates
TRANSPORTATION SOLUTIONS



0 500 1,000 2,000 3,000 4,000 Feet

Table 3-4 Functional Classification Comparison Arterial and Collector Streets

Roadway	ODOT	Metro	Clackamas County	City of Milwaukie	ROW/ Pavement Width (ft)
McLoughlin Blvd	Urban Principal Arterial—Other	Principal Arterial (Highway)/ Major Arterial	Major Arterial	Freeway/ Regional Route	110-120/ 65-140
Hwy 224	Urban Principal Arterial—Other Fwy or Expy	Principal Arterial (Highway)	Freeway/ Expressway	Freeway/ Regional Route	165/80-100
17 th Ave	—	—	Minor Arterial	Arterial	35-60/60
21 st Ave	—	Minor Arterial	Minor Arterial	Arterial	60/45
22 nd Ave	—	—	Minor Arterial	Arterial	60/25-40
Harrison St	—	Minor Arterial	Minor Arterial	Arterial	60/20-50
Harmony Rd	—	Major Arterial	Major Arterial	Arterial	60/35-60
Johnson Creek Blvd	—	—	Minor Arterial	Arterial	60/30-50
King Rd	—	Minor Arterial	Minor Arterial	Arterial	60/20-50
Linwood Ave	—	Minor Arterial	Minor Arterial	Arterial	60/35-50
Lake Rd	—	Minor Arterial	Minor Arterial	Arterial	60/30-60
Oatfield Rd	—	Minor Arterial	Minor Arterial	Arterial	60/35-40
Railroad Ave	—	Minor Arterial	Collector	Collector	60/20-35
River Rd	—	—	Minor Arterial	Arterial	60/20-35
32 nd Ave	—	—	Collector	Collector	60/25-40
34 th Ave	—	—	Collector	Collector	60/35-40
37 th Ave	—	—	Local	Collector/ Neighborhood Route	60/30-40
42 nd Ave	—	—	Collector	Collector/ Neighborhood Route	60/30-35
43 rd Ave	—	—	Collector	Collector	40-60/25-30
Bell Ave	—	—	Collector	Collector	60/30-40
Home Ave	—	—	Local	Neighborhood Route	50/20-25
Jackson St	—	—	Collector	Collector	60-80/15-60
Jefferson St	—	—	Collector	Collector	50-70/20-45
Main St	—	—	Collector	Collector	80/30-55
Monroe St	—	—	Collector	Collector	60-70/20-45
Oak St	—	—	Collector	Collector	60/35-50
Rusk Rd	—	—	Collector	Collector	40/25-30
Stanley Ave	—	—	Collector	Collector	60/20
Washington St	—	—	Collector	Collector	60/20-40

Sources: ODOT, Oregon Highway Plan, 1999, and Metro, 2010 Regional Transportation Plan (RTP), Regional System Concepts and Policies.

Figure 3-8 illustrates roadway ownership and maintenance of the various roads in Milwaukie. McLoughlin Blvd and Hwy 224 are State facilities. Hwy 224 is classified as a Principal Arterial. McLoughlin Blvd is classified as a Principal Arterial north of Hwy 224 and a Major Arterial south of Hwy 224. As such, the preferred regional mobility route through Milwaukie from Portland is along McLoughlin Blvd to Hwy 224, and along Hwy 224 to I-205 and destinations outside of the

city of Milwaukie. The majority of arterial and collector roadways outside the city limit but within the city's Urban Growth Management Area are owned and operated by Clackamas County or ODOT. The City is responsible for the majority of the roads inside the city limits.

Roadway Characteristics

Field inventories of posted speed limits, number of roadway lanes, and intersection controls were conducted to determine characteristics of major roadways in the TSP study area. These characteristics define roadway capacity and operating speeds through the street system, which affect travel path choices for drivers in Milwaukie.

Posted Speed Limits

A limited inventory of the posted speeds in Milwaukie can be seen in Figure 3-9. Collector roadways such as King Rd, Railroad Ave, and Monroe St have posted speeds ranging from 25 to 40 miles per hour (mph). The majority of local access roadways in Milwaukie are posted at 25 mph. Arterial roadways such as McLoughlin Blvd, Hwy 224, and Johnson Creek Blvd are posted at higher speeds ranging from 30 to 50 mph.

Intersection Controls

Figure 3-10 illustrates the existing intersection controls at major roads in Milwaukie. Traffic signals exist mainly along McLoughlin Blvd and Hwy 224. Harrison St, Lake Rd, and Linwood Ave have a few signals and one of the intersections along Johnson Creek Blvd is also signalized. The study intersections for this TSP Update include eighteen signalized intersections and four intersections without signals.

Roadway Width

The widest roadways are McLoughlin Blvd and Hwy 224. Harrison St widens near Hwy 224, but is primarily a two-lane road. King St has three lanes, as do some sections of Lake Rd. The remaining roads in the city are one or two lane roads.

Stormwater Management

A roadway is not only limited to what can be seen on the surface; there are also other aspects which can affect a roadway's performance and longevity, such as its the base, the materials and methods used in construction, and drainage features. Many of these topics go beyond the scope of a transportation system plan; however, the issue of drainage will be briefly touched upon. A properly designed, constructed, and maintained stormwater drainage system—which can include a combination of gutters, curbs, storm drains, and storm sewers—minimizes water pollution and reduces the risk of flooding and erosion that can interrupt functioning of the transportation system.

Figure 3-11 shows the locations of the City of Milwaukie's stormwater system. This map also shows locations identified by City staff where rainwater drainage has been problematic. Many of these locations correlate to streets with no gutters, curbs, or sidewalks. Railroad Ave, for instance, has drainage issues along its length from 37th Ave nearly to Linwood Ave. Many of the streets with drainage issues do not have curbs, gutters, or sidewalks. However, there are many other locations throughout the city that do not have these amenities and do not have drainage issues.



Transportation System Plan

FIGURE 3-8

ROADWAY JURISDICTION

November 2013

LEGEND

Jurisdiction

- State of Oregon
- Clackamas County
- City of Portland
- Joint Milwaukie/Portland
- Private

NOTE: All other roads within Milwaukie are under authority of the City.

Other Map Features

- Schools
- Major Roads
- Streets
- Railroad
- Kellogg Creek Trail
- Springwater Trail
- Trolley Trail
- County Line
- Water
- Parks
- City Limits
- Light Rail Station
- Light Rail Transit



DKS Associates
TRANSPORTATION SOLUTIONS



0 500 1,000 2,000 3,000 4,000 Feet



Transportation System Plan






FIGURE 3-9

POSTED SPEED INVENTORY

November 2013



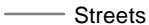




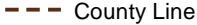



LEGEND

Speed Limits

-  30
-  35
-  40
-  45
-  50

NOTE: All other roads assumed to be 25 MPH.

Other Map Features

-  Schools
-  Major Roads
-  Streets
-  Railroad
-  Kellogg Creek Trail
-  Springwater Trail
-  Trolley Trail
-  County Line
-  Water
-  Parks
-  City Limits



DKS Associates
TRANSPORTATION SOLUTIONS



0 500 1,000 2,000 3,000 4,000 Feet



Transportation System Plan

FIGURE 3-11

STORMWATER AND TOPOGRAPHY

November 2013

LEGEND

Stormwater Features

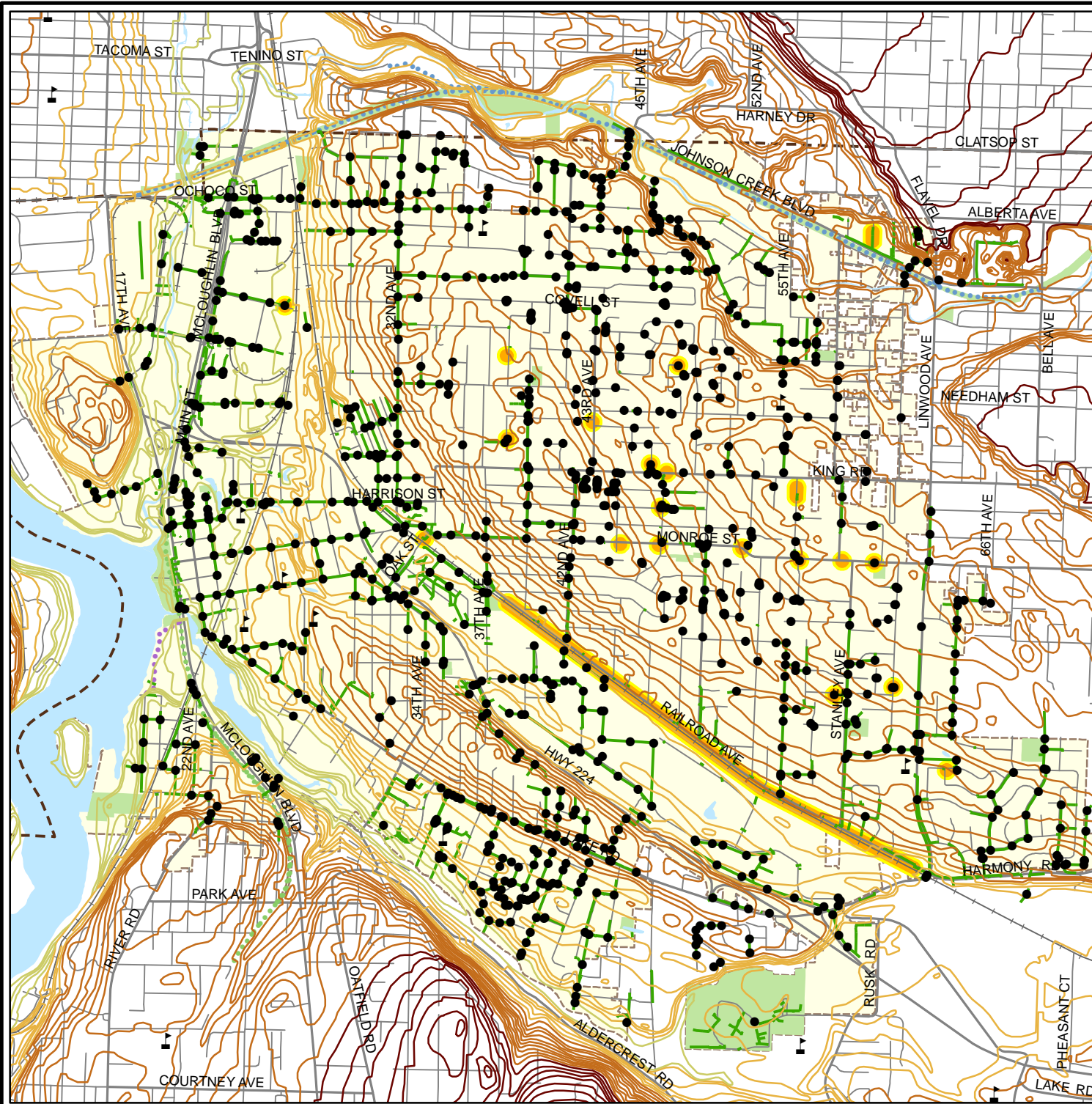
- Manholes and Drywells
- Pipes
- Locations with Drainage Issues

Elevation Above Sea Level

- < 50 feet
- 50 - 100 feet
- 100 - 200 feet
- > 200 feet

Other Map Features

- Schools
- ⋯ Kellogg Creek Trail
- ⋯ Springwater Trail
- ⋯ Trolley Trail
- Major Roads
- Streets
- Railroad
- - - County Line
- Water
- Parks
- ▭ City Limits



DKS Associates
TRANSPORTATION SOLUTIONS



0 500 1,000 2,000 3,000 4,000 Feet

Pavement Conditions

The City of Milwaukie has conducted an extensive visual inspection of its roadways as part of an ongoing Pavement Management System (PMS). PMS is a tool for making cost-effective decisions about pavement maintenance and rehabilitation. Pavement conditions are recorded in the TSP to document existing conditions, but no recommendations are made about the schedule of surface maintenance projects. The PMS tool is utilized by the Street Surface Maintenance Program (SSMP), which was established in 2006 to fund the assessment, maintenance, and repair of street surfaces in the city. It is the function of the SSMP to determine the schedule of surface maintenance projects. Figure 3-12 shows the location and extent of current, completed, and future SSMP projects.

As part of the ongoing SSMP project selection process, sections of a roadway have been rated on a Pavement Condition Index (PCI), a scale that rates a roadway's condition from 0 to 100. High numbers correlate to newer streets in good condition (70-100), while lower numbers (50 or less) indicate roads that have deteriorated to the point of needing rehabilitation or replacement. Milwaukie's complete PCI survey is updated on an annual basis.

An average PCI was calculated for the three different city street classifications—arterial, collector, and residential/local—based on the length of street covered by a specific PCI rating. These findings are summarized in Table 3-5. From the table, it can be seen that, on average, the road condition for all three street types is relatively close. On average, arterial streets have the highest rating, followed by collectors and then residential/local streets.

Table 3-5 Average Pavement Condition Index

Classification	Length (lane miles)	Average Pavement Condition Index
Arterial	12.23	78
Collector	24.97	64
Residential/Local	111.1	58

Source: City of Milwaukie PCI Survey, 2013

Table 3-6 lists the breakdown of PCI ratings throughout the city for each street type by length of roadway and percentage. This more detailed look into the pavement condition shows that the majority of the arterial (73.1%), collector (61.8%) and residential/local (61.8%) streets can be considered in good to excellent condition. Over half of Milwaukie's streets rank in the very good to good category. In general 36%, or 26.73 miles, of the streets in the city are considered to be in poor to very poor condition. The street sections with the lowest PCI included Maple Ct, 56th Ave, and Lloyd St.

Table 3-6 Pavement Condition Index Rating by Functional Classification

Rating (PCI Score)	Street Type (as rated by segment)			
	Arterial	Collector	Residential/Local	Total
Very Good (85-100)	61.7%	44.4%	45.4%	46.4%
Good (70-85)	11.4%	25.3%	16.4%	17.5%
Poor (50-70)	6.9%	26.7%	14.8%	16.3%
Very Poor (0-50)	20%	3.6%	23.4%	19.8%

Source: City of Milwaukie PCI Survey, 2013



Transportation System Plan

FIGURE 3-12

LOCATION OF STREET SURFACE MAINTENANCE PROGRAM (SSMP) PROJECTS

November 2013

LEGEND

- Current SSMP Projects (FY 13/14')
- Future SSMP Projects
- Completed SSMP Projects

Other Map Features

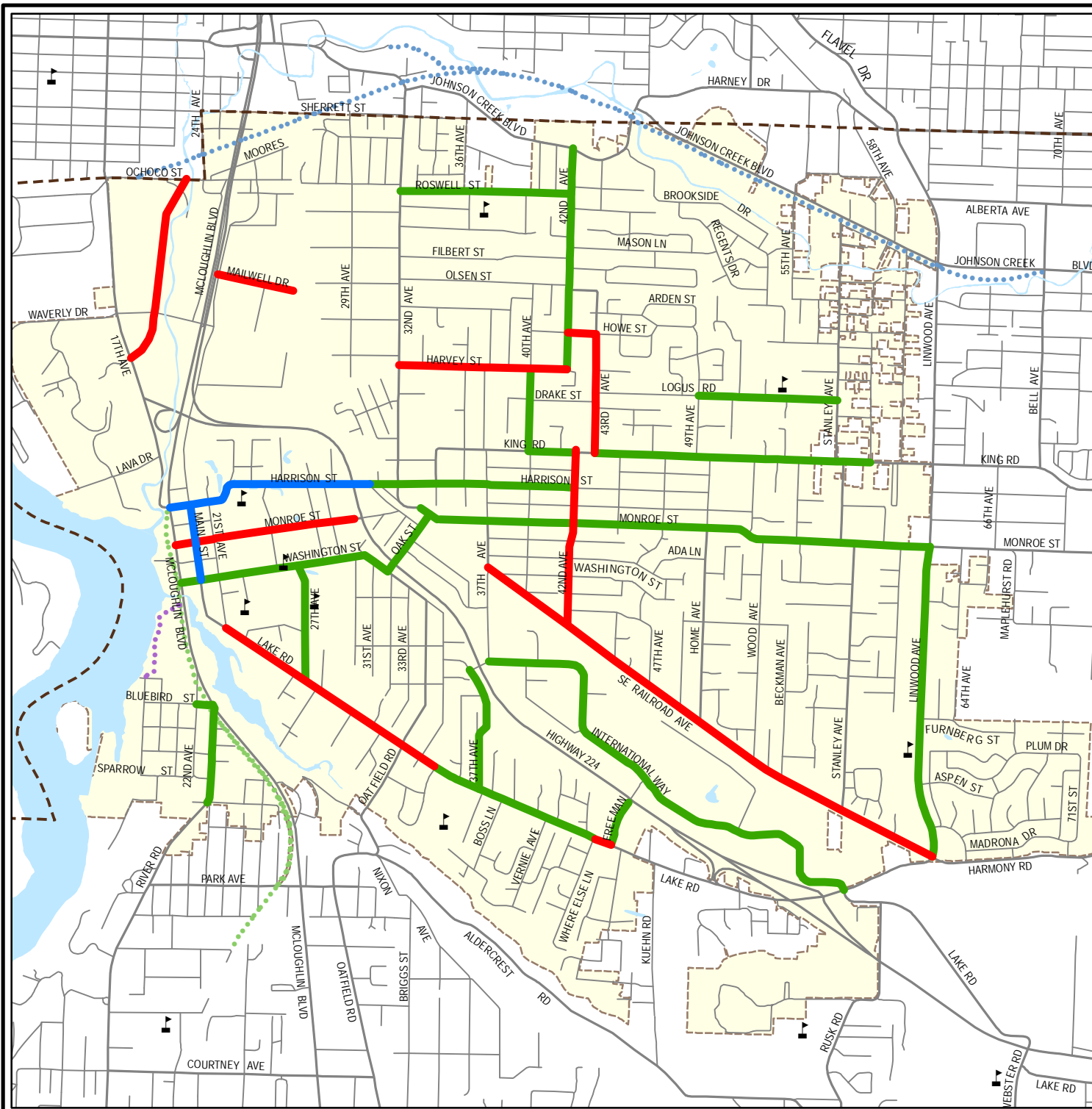
- Schools
- Kellogg Creek Trail
- Springwater Trail
- Trolley Trail
- County Line
- Water
- Major Roads
- City Limits

*Current as of November 2013. Location and extent of future projects subject to change.

DKS Associates
TRANSPORTATION SOLUTIONS



0 500 1,000 2,000 3,000 4,000 Feet



Motor Vehicle Volume

Twenty-four-hour traffic count data was collected at select locations within the city. It is useful to analyze this data to determine traffic flow throughout the day on the transportation network. Figure 3-13a is an hour-by-hour breakdown of traffic volumes along McLoughlin Blvd and Hwy 224, and shows two distinct peaks in traffic volumes on the Milwaukie's two highest traffic volume streets.⁸ These two peaks represent the a.m. and p.m. peak commuter traffic. The traffic volumes observed on McLoughlin Blvd show the typical a.m. and p.m. peak spike in commuter vehicular traffic demand. Hwy 224 also shows a.m. and p.m. peak spikes in demand, it is however unusual that the a.m. peak hour is greater than the p.m. peak hour. This type of travel pattern is unusual, because the a.m. peak hour usually consists of commuter traffic, whereas, the p.m. peak hour traffic volume contains many of the a.m. commuters, as well as those with retail and other miscellaneous destinations.

Figure 3-13b shows the 24-hour, two-way existing traffic volumes on streets in Milwaukie from 2005 and 2006. The locations of these counts correspond to locations counted on an annual basis by ODOT⁹ and/or Clackamas County.¹⁰ When compared to 24-hour traffic counts taken for the 1997 TSP, there has been growth on many of the streets within city limits. Figure 3-13c shows the location and change in traffic volume at select locations recorded in 1995 (basis for 1997 Milwaukie TSP).

In addition, an inventory of peak-hour traffic counts at study area intersections was conducted in the Fall/Winter of 2006. The traffic turn movement counts establish baseline information for future monitoring and identify current existing problem areas. Turn movement counts were conducted at twenty-two intersections during the evening peak period (4:00-6:00 p.m.) to determine existing operating conditions and are shown in Figures 3-14a and 3-14b. The p.m. peak-hour turn movements are useful when analyzing the operational characteristics of an intersection, since they generally represent the hour of highest traffic volume demand. It is assumed that if an intersection operates sufficiently during the p.m. peak hour it will operate sufficiently during the rest of the day. Study intersections were chosen in coordination with the City staff to address major roadways and noted areas of concern.

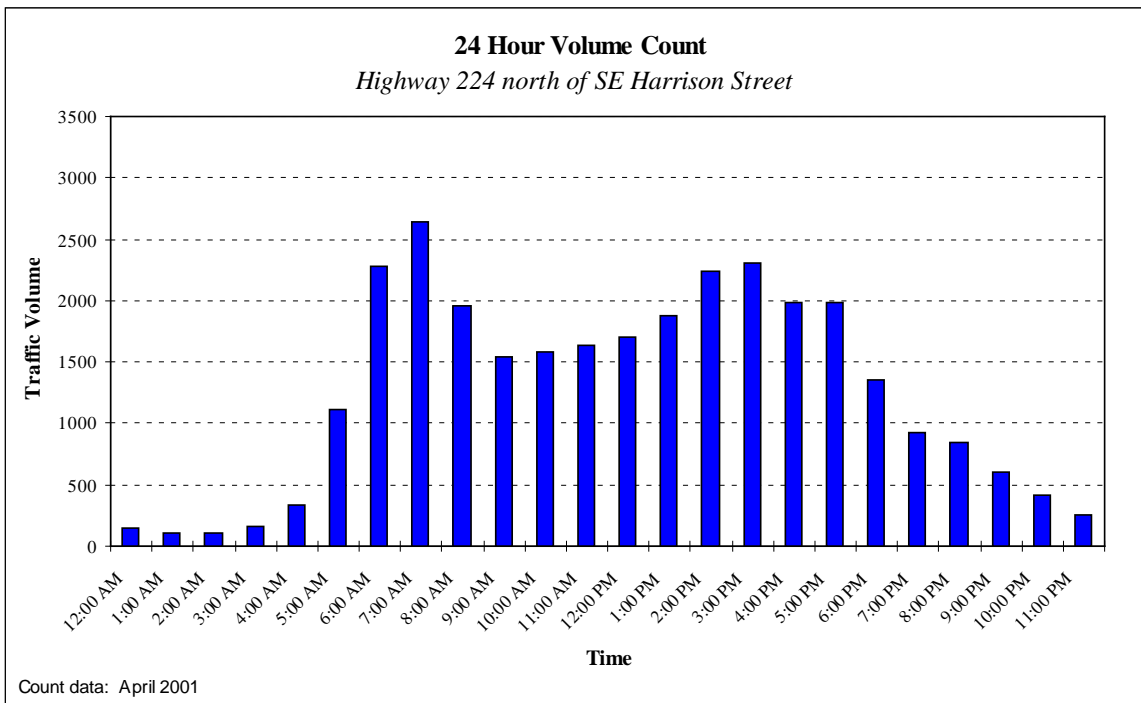
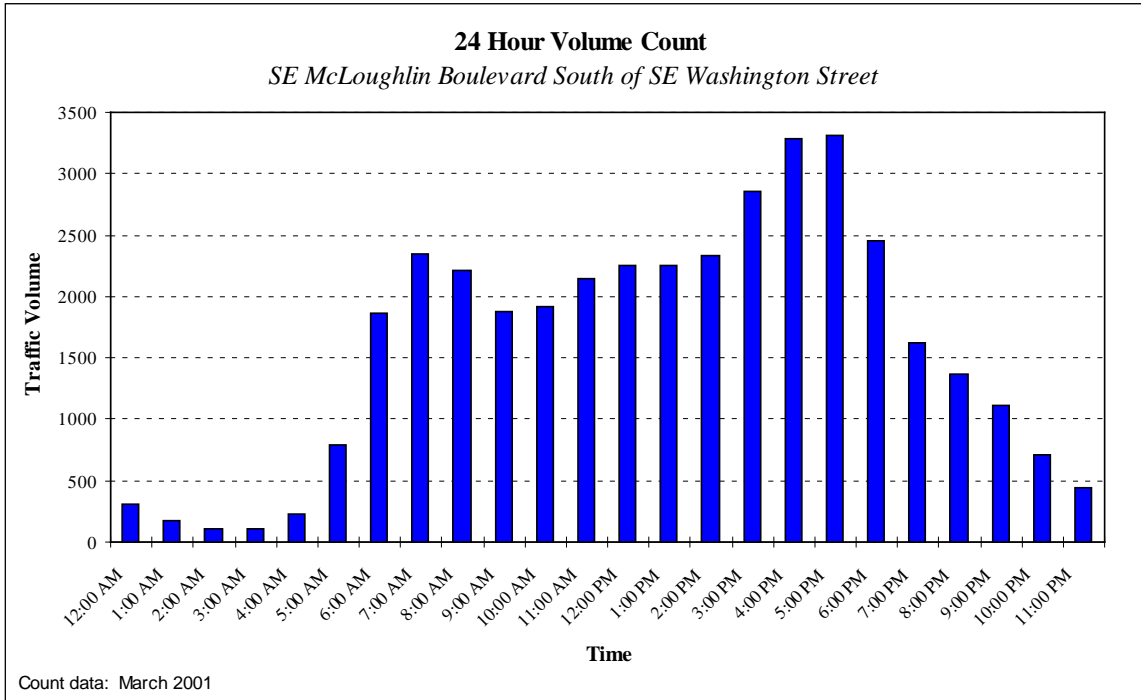
The p.m. peak-hour signal warrants were evaluated for all study area intersections without signals. The intersections of Harrison St/Main St and 32nd St/Johnson Creek Blvd both met the p.m. peak-hour signal warrants. This indicates that further study of these intersections is recommended to see if they would meet other ODOT required signal warrants. The peak-hour warrants can be found in Appendix G.

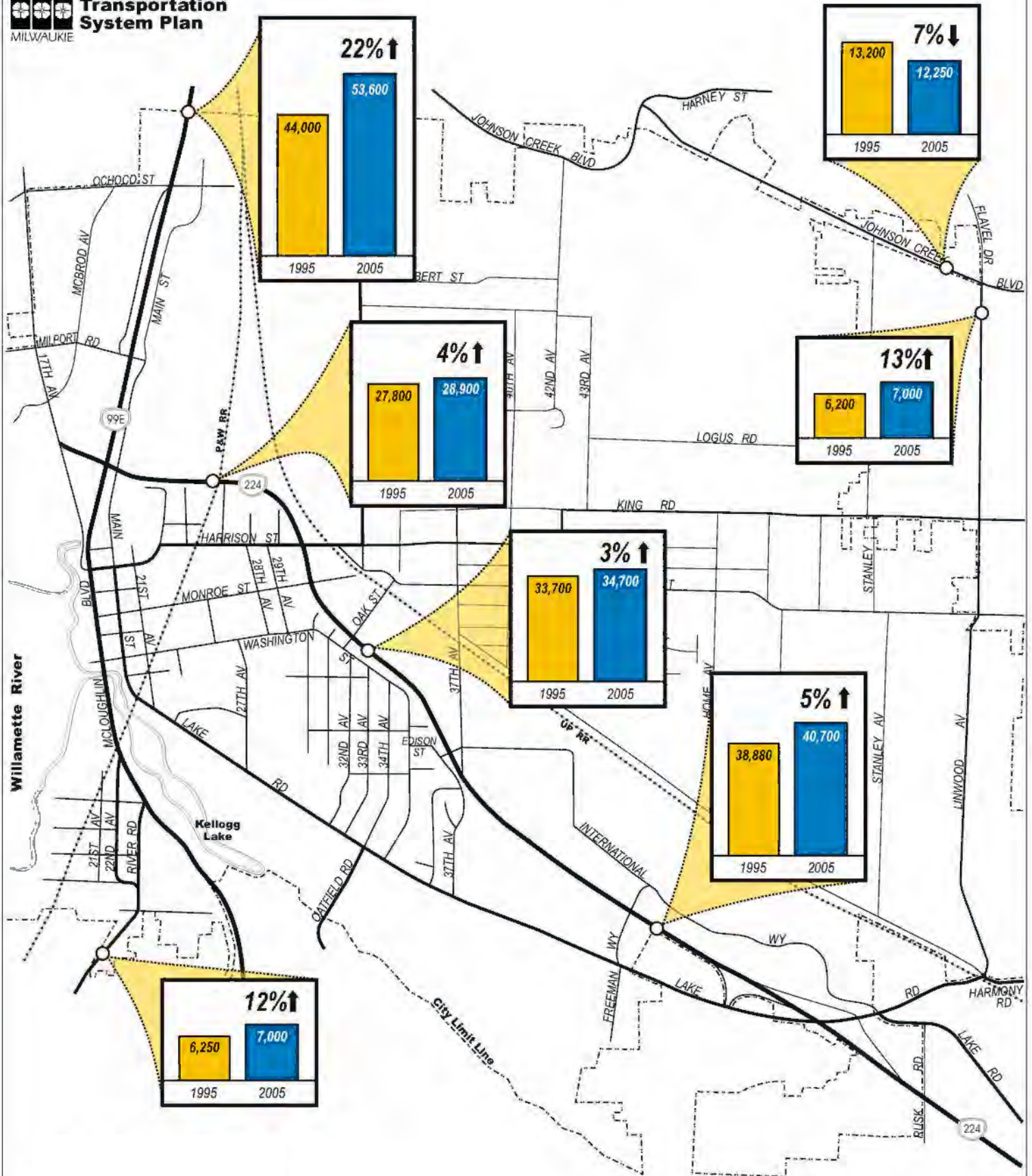
⁸ The 24-hour tube count data was collected in 2001 and was not refreshed as part of the 2007 update. Analysis of available data from Clackamas County and ODOT as well as from the PMLR project demonstrated that there have been no significant changes overall in traffic volumes since 2006-07. It was not necessary to refresh these data at this time; a more extensive update to the TSP in the future should revisit this issue.

⁹ ODOT Annual Traffic Counting Program.

¹⁰ Clackamas County Annual Traffic Counting Program.

Figure 3-13a 24-Hour Tube Count Data on McLoughlin Blvd and Hwy 224





LEGEND

- 24 Hour Count Volume (1995)
- 24 Hour Count Volume (2005)

DKS Associates
TRANSPORTATION SOLUTIONS

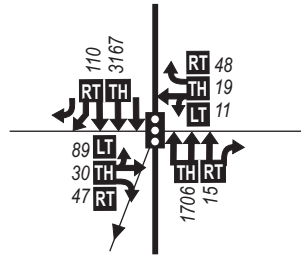


Figure 3-13C

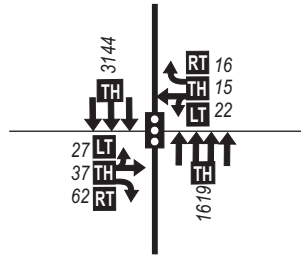
**24 HOUR COUNT VOLUMES
HISTORIC COMPARISON**

March 2007

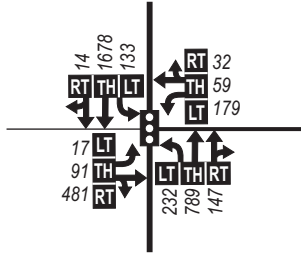
1 SE McLoughlin Blvd @ SE Ochoco St



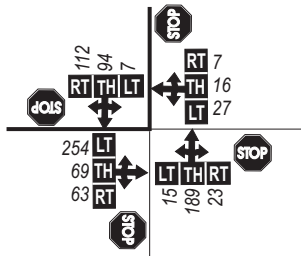
2 SE McLoughlin Blvd @ SE Milport Rd



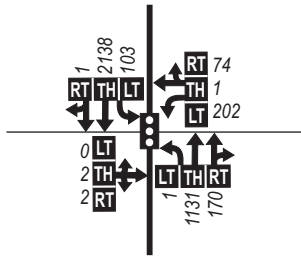
3 SE McLoughlin Blvd @ SE Harrison St/17th Av



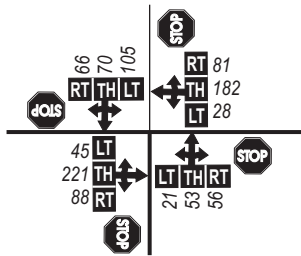
4 SE 42nd Av @ SE Harrison St



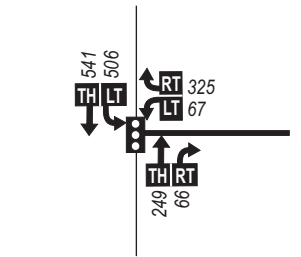
5 SE McLoughlin Blvd @ SE Washington St



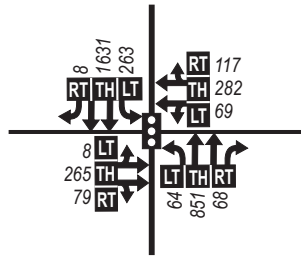
6 SE Harrison St @ SE Main St



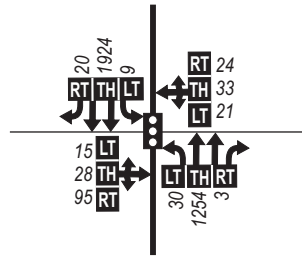
7 Hwy 224 @ SE 17th Av



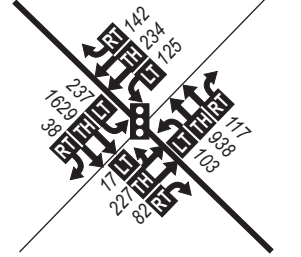
8 Hwy 224 @ SE Harrison St



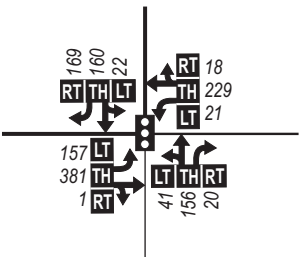
9 Hwy 224 @ SE Monroe St



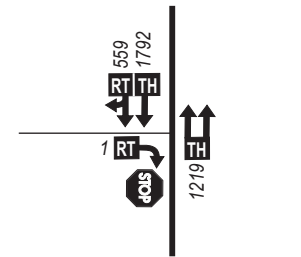
10 Hwy 224 @ SE Oak St



11 SE Harrison St @ SE 32nd Av



12 SE McLoughlin Blvd @ SE 22nd Av



LEGEND

- X● - Study Intersection & Number (This Sheet)
- X○ - Study Intersection & Number (Next Sheet)
- ← - Lane Configuration
- STOP - Stop Sign
- ⬆ - Traffic Signal

00 - PM Peak Hour Traffic Volume*
 LT|TH|RT - Volume Turn Movement
 Left+Thru+Right

Counts revised/added in 2013 for intersections 21, 23, 24

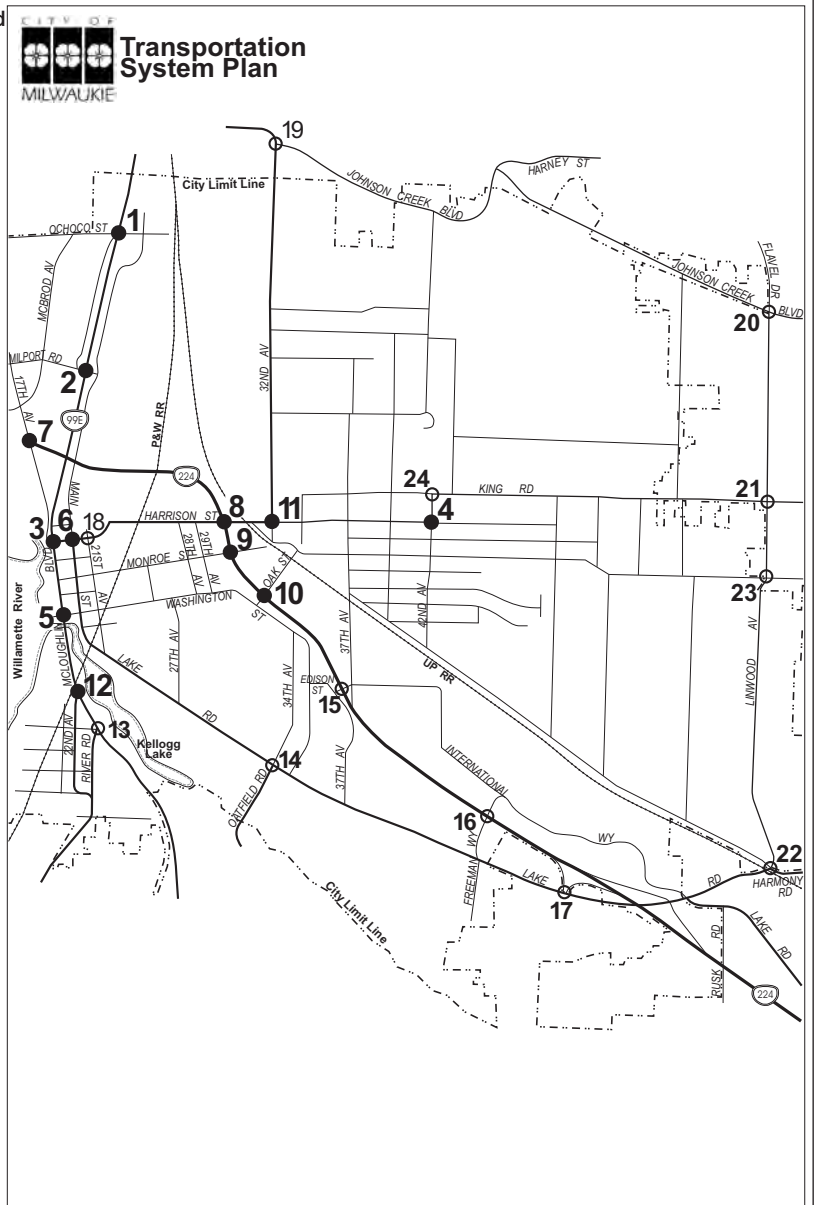
* Traffic Volume Count Conducted in the Fall/Winter 2006

DKS

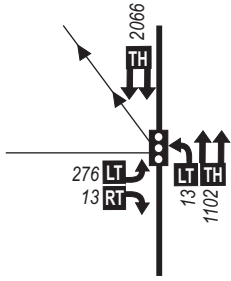


Figure 3-14a

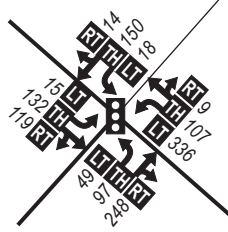
EXISTING PM PEAK HOUR TRAFFIC VOLUMES



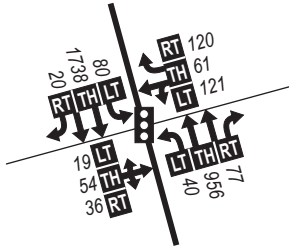
13 SE McLoughlin Blvd @ SE River Rd



14 SE Lake Rd @ SE Oatfield Rd



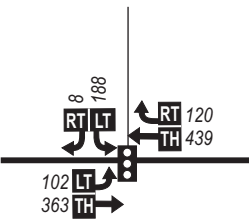
15 Hwy 224 @ SE 37th Av / SE Edison St



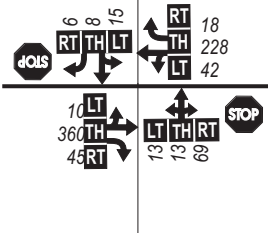
16 Hwy 224 @ SE Freeman Wy



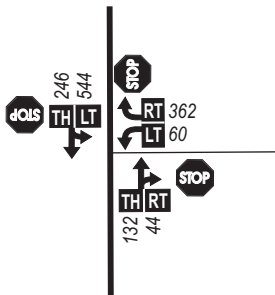
17 Hwy 224 @ SE Lake Rd



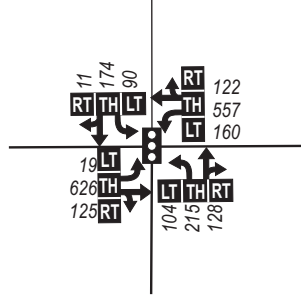
18 SE 21st Av @ SE Harrison St



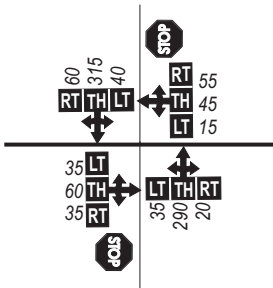
19 SE 32nd Av @ SE Johnson Creek Blvd



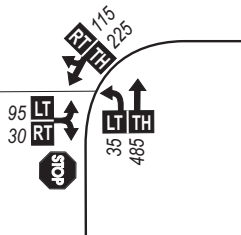
20 SE Johnson Creek Blvd @ SE Linwood Av



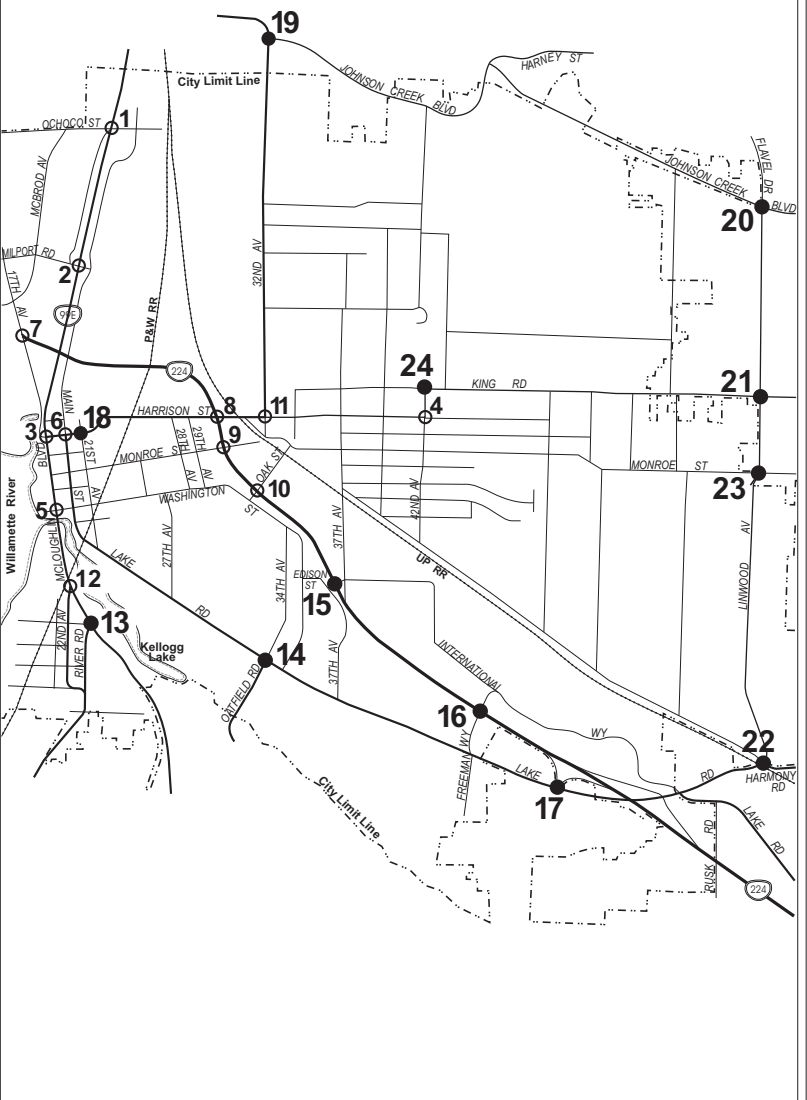
23 SE Linwood Av @ SE Monroe St



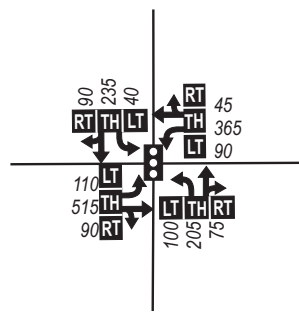
24 SE King Rd @ SE 42nd Av



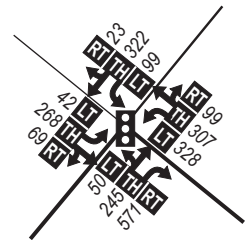
CITY OF MILWAUKIE
Transportation System Plan



21 SE Linwood Av @ SE King Rd



22 SE Harmony Rd @ SE Linwood Av



LEGEND

- X● - Study Intersection & Number (This Sheet)
 - X○ - Study Intersection & Number (Previous Sheet)
 - LT|TH|RT - Volume Turn Movement (Left+Thru+Right)
 - ← - Lane Configuration
 - STOP - Stop Sign
 - ⬇ - Traffic Signal
 - 00 - PM Peak Hour Traffic Volume*
- Counts revised/added in 2013 for intersections 21, 23, 24
* Traffic Volume Count Conducted in the Fall/Winter 2006

DKS



Figure 3-14b

EXISTING PM PEAK HOUR TRAFFIC VOLUMES

Land Use

In addition to major regional highways, such as Hwys 224 and 99E, land use within Milwaukie is a key factor in understanding current transportation patterns and roadway traffic volumes as it plays a large role in driving transportation choices. The adopted land use zoning designations within the city boundaries are shown in Figure 3-15.

Measures of Effectiveness

Level of service (LOS) is used as a measure of effectiveness for the operation of both signalized and unsignalized intersection operation. It is similar to a "report card" rating based upon average vehicle delay.

- LOS A, B, and C indicate conditions where traffic moves without significant delays over periods of peak-hour travel demand.
- LOS D and E are progressively worse peak-hour operating conditions.
- LOS F represents conditions where average vehicle delay exceeds 80 seconds per vehicle entering a signalized intersection and demand has exceeded capacity.

LOS F is typically evident in long queues and delays. LOS D or better is generally the accepted standard for signalized intersections in urban conditions.

At intersections without signals, a LOS E and even LOS F can occur for a specific turning movement; however, the majority of traffic may not be delayed (in cases where major street traffic is not required to stop). When these conditions exist, it generally provides a basis to study the intersections further to determine the availability of acceptable gaps for vehicles that are stopped and waiting to enter the traffic flow. It also indicates an intersection where traffic signal warrants should be conducted to determine if the intersection is reaching a point where it could be considered for signalization. A summary of level of service descriptions for signalized and unsignalized intersections is provided in Appendix F.

Intersections within the city are subject to one or more measure of effectiveness standards from the City, Metro, and ODOT. Milwaukie has a LOS D standard during the peak operating conditions for all intersections that fall within the City's jurisdiction.¹¹ Metro also uses a LOS standard, but further refines its requirements to include the top two peak hours. Their LOS standard is F for the first peak hour and E for the second peak hour.¹² ODOT uses a volume to capacity ratio (V/C) as a measure of effectiveness, which is similar to LOS, but is a ratio of the volume of vehicles traveling through an intersection to its calculated capacity. Similar to Metro, ODOT has two sets of maximum acceptable V/C ratios for the Hwys 99E and 224 in Milwaukie. These standards are outlined in Table 3-7.

¹¹ Milwaukie Municipal Code, Section 19.1407.4(A).

¹² Regional Transportation Plan, Metro, 2000, Table 1.2.



Transportation System Plan








FIGURE 3-15

ZONING MAP













November 2013

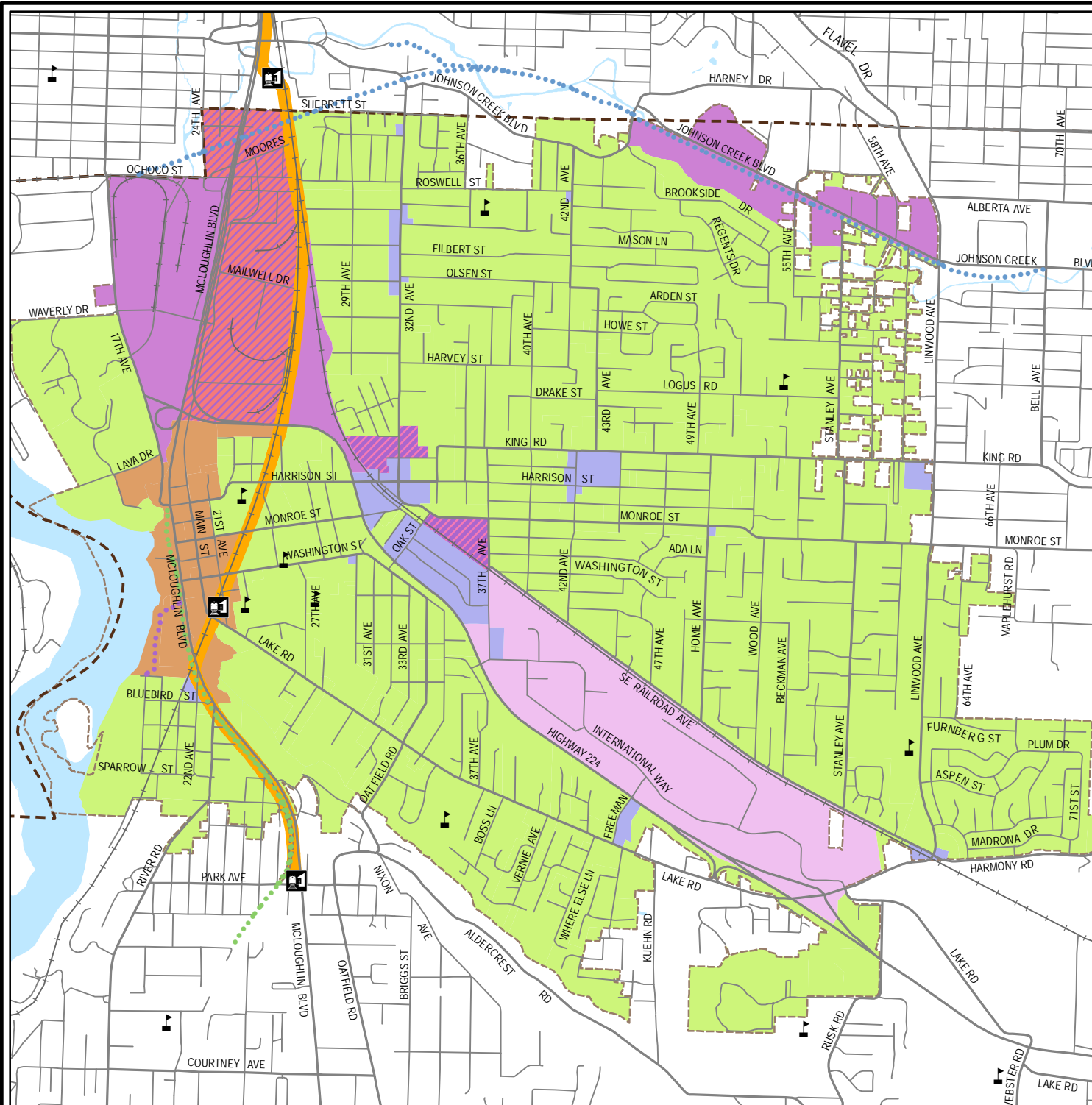
LEGEND

Zoning

-  Business Industrial
-  Manufacturing
-  Commercial
-  Downtown
-  MTSA (Manufacturing - Tacoma Station Area)
-  Residential
-  Mixed Use

Other Map Features

-  Schools
-  Kellogg Creek Trail
-  Springwater Trail
-  Trolley Trail
-  Light Rail Station
-  Light Rail Transit
-  Major Roads
-  Streets
-  Railroad
-  County Line
-  Water
-  City Limits



DKS Associates
TRANSPORTATION SOLUTIONS



0 500 1,000 2,000 3,000 4,000 Feet

Table 3-7 Existing P.M. Peak-Hour Study Area Intersection Operations

Intersection	Minimum Acceptable Measure of Effectiveness (MOE)			Level of Service (LOS)	Average Delay (Seconds)	Volume/Capacity (V/C)
	City ¹³	Metro ¹⁴	ODOT ¹⁵			
Two-Way Stop Controlled Intersections						
McLoughlin Blvd @ 22 nd Ave		F/E	0.99/0.99	A/D	26.4	0.01
Harrison St @ 21 st Ave	D			A/C	18.0	0.10
All-Way Stop Controlled Intersections						
Harrison St @ Main St	D			B	13.2	0.39
42 nd Ave @ Harrison St	D			B	14.3	0.22
Johnson Creek Blvd @ 32 nd Ave	D			F	>50	0.77
Signalized Intersections						
McLoughlin Blvd @ Ochoco St		F/E	1.10/0.99	B	10.1	0.85
McLoughlin Blvd @ Milport Rd		F/E	1.10/0.99	A	4.4	0.78
McLoughlin Blvd @ Harrison St		F/E	1.10/0.99	D	47.1	0.99
McLoughlin Blvd @ Washington St		F/E	1.10/0.99	C	20.0	0.88
Hwy 224 @ 17 th Ave		F/E	0.99/0.99	C	20.7	0.59
Hwy 224 @ Harrison St		F/E	0.99/0.99	D	40.0	0.89
Hwy 224 @ Monroe St		F/E	0.99/0.99	B	19.0	0.75
Hwy 224 @ Oak St		F/E	0.99/0.99	D	44.1	0.88
Harrison St @ 32 nd Ave	D	F/E		B	10.5	0.45
McLoughlin Blvd @ River Rd		F/E	0.99/0.99	D	35.5	0.99
Lake Rd @ Oatfield Rd		F/E		D	36.0	0.62
Hwy 224 @ 37 th Ave		F/E	0.99/0.99	C	25.5	0.82
Hwy 224 @ Freeman Way		F/E	0.99/0.99	C	30.5	0.94
Hwy 224 @ Lake Rd		F/E	0.99/0.99	B	16.1	0.68
Johnson Creek Blvd @ Linwood Ave	D	F/E		D	53.6	0.97
Linwood Ave @ King Rd	D	F/E		D	47.5	0.83
Linwood Ave @ Harmony Rd	D	F/E		E	64.5	0.94

Signalized and All-Way Stop Intersection LOS:

- **LOS** = Level of Service
- **Delay** = Average vehicle delay in the peak hour for entire intersection
- **V/C** = Volume to Capacity Ratio
- **MOE** = (ODOT & Metro) First Peak Hour/Second Peak Hour

Unsignalized Intersection LOS:

- **A/A** = Major Street turn LOS/Minor street turn LOS

Turn movement counts taken at the study intersections and conducted during the evening peak periods were used to determine the existing 2006 LOS based on the 2000 Highway Capacity Manual methodology for signalized and unsignalized intersections.¹⁶

¹³ Milwaukie Municipal Code, Section 19.1407.4(A).

¹⁴ Regional Transportation Plan, Metro, 2000, Table 1.2.

¹⁵ 1999 Oregon Highway Plan Alternative Highway, Maximum Volume to Capacity Ratios Within Portland Metropolitan Region, Oregon Department of Transportation, January 2006, Table 7.

Traffic counts and level of service calculation sheets can be found in Appendix G. A list of results for existing p.m. peak-hour intersection operation at the twenty-two study intersections is shown in Table 3-7. All but four study intersections operate at an LOS of D or better. The intersection of Johnson Creek Blvd/32nd Ave operates at LOS F during the peak hour.

Safety

ODOT ranks intersections in their Safety Priority Index System (SPIS) based on the most current three years of collision data. The SPIS values range from one to one hundred, with lower values equating to lower collision rates. The score is derived from the number of collisions, the type of collisions, collision severity, and traffic volumes. Each year, a list of the top 10% SPIS sites is generated and the top 5% sites are investigated by ODOT for safety problems. If ODOT identifies a correctable problem, a benefit/cost analysis is performed and appropriate projects are initiated, often with funding from the Highway Safety Improvement Program. None of the 22 study intersections were identified as being on the SPIS top 10% list.

In addition to SPIS data, intersection safety is also analyzed using intersection collision rates. Collision rates are measured as the number of collisions per million entering vehicles (MEV). This measure allows comparison of intersections with varying volumes. ODOT provided collision data for the study intersections along the State facilities, McLoughlin Blvd and Hwy 224. All collisions involving a fatality, injury, or property damage greater than \$1,500 are included in the reports supplied by ODOT. The crash rates and corresponding data can be seen in Table 3-8. Further investigation should be conducted at the intersection of Hwy 224/Lake Rd, since the corresponding crash rate is greater than 1.0, indicating that the intersection might have safety problems.

¹⁶ 2000 Highway Capacity Manual, Transportation Research Board, 2000.

Table 3-8 SPIS Rating of Milwaukie TSP Update Study Area Intersections

Inter-section Number	ODOT SPIS Rating	Street	Cross Street	Intersection Collisions (2002-2005) ¹	Fatal	Injury	Corridor Collisions 2002-2005 ²	Collision Rate 2002-2005 ³
17	74.81	Hwy 224	Lake Rd	15	1	7	21	1.12
10	34.42	Hwy 224	Oak St	22	0	12	16	0.52
2	50.42	McLoughlin Blvd	Milport Rd	9	0	4	18	0.17
3	49.48	McLoughlin Blvd	Harrison St	8	0	3	24	0.19
15	20.2	Hwy 224	Edison St	1	0	1	7	0.03
8	52.82	Hwy 224	Harrison St	10	0	4	18	0.25
13	23.72	McLoughlin Blvd	River Rd	5	0	0	15	0.13
12	14.47	McLoughlin Blvd	22 nd Ave	1	0	1	16	0.03
7	11.03	Hwy 224	17 th Ave	2	0	1	9	0.10
1	21.27	McLoughlin Blvd	Ochoco St	5	0	4	8	0.09
16	21.7	Hwy 224	Freeman Way	4	0	3	5	0.11
5	39.68	McLoughlin Blvd	Washington St	2	0	1	6	0.05
9	26.95	Hwy 224	Monroe St	5	0	2	7	0.13
4	N/A	42 nd Av	Harrison St	4	0	1	N/A	0.42
6	N/A	Harrison St	Main St	6	0	4	N/A	0.53
11	N/A	Harrison St	32 nd Ave	12	0	8	N/A	0.80
14	N/A	Lake Rd	Oatfield Rd	7	0	1	N/A	0.49
18	N/A	21 st Ave	Harrison St	3	0	2	N/A	0.33
19	N/A	32 nd Ave	Johnson Creek Blvd	0	0	0	N/A	0.00*
20	N/A	Johnson Creek Blvd	Linwood Ave	7	0	6	N/A	0.27
21	N/A	Linwood Ave	King Rd	2	0	1	N/A	0.09
22	N/A	Harmony Rd	Linwood Ave	19	0	10	N/A	0.72

¹ Collisions within the intersection: reported by City/County/State Police to ODOT.

² Collisions along McLoughlin Blvd or Hwy 224 within 0.05 miles of the intersection: reported by City/County/State Police to ODOT.

³ Collision Rate = (Number of Collisions x 1,000,000)/(Number of Years of Data x 365 x Annual Average Daily Traffic)

*No crashes were recorded at this intersection.

Heavy Vehicles

The economical movement of raw materials and finished products depends on efficient truck movement to and through urban areas. The designation of through truck routes provides for efficient movement while at the same time maintaining neighborhood livability, public safety, and minimizing maintenance costs of the roadway system. McLoughlin Blvd and Hwy 224 are identified by ODOT,¹⁷ Metro, and the City of Milwaukie as truck routes. The City identifies truck routes on roads under its jurisdiction. Truck routes are illustrated in Figure 3-16.

Truck (or heavy vehicle) volumes were collected as part of the intersection turn movement counts. Any vehicle with more than two axles was considered a heavy vehicle. The number of trucks was totaled and divided by the total number of vehicles in the traffic stream to get the percentage of trucks. Seven of the twenty-two studied intersections present truck volumes exceeding 100 vehicles per hour (vph), with volumes exceeding 150 vph at the Hwy 99E and Ochoco St intersection.

¹⁷ 1999 Oregon Highway Plan, The Oregon Department of Transportation, May 1999.



Transportation System Plan

FIGURE 3-16

TRUCK ROUTES

November 2013

LEGEND

Freight Routes

- Major Regional
- Minor Preferred (Local)
- Weight Restricted
- Minor Preferred (Local)

Freight Volumes

- 0 - 50 Heavy Vehicles/Hour
- 51 - 100 Heavy Vehicles/Hour
- 101 - 150 Heavy Vehicles/Hour
- > 150 Heavy Vehicles/Hour

Other Map Features

- Schools
- Kellogg Creek Trail
- Springwater Trail
- Trolley Trail
- Light Rail Transit
- Light Rail Station
- Major Roads
- Streets
- Railroad
- County Line
- Water
- Parks
- City Limits



DKS Associates
TRANSPORTATION SOLUTIONS



0 500 1,000 2,000 3,000 4,000 Feet

Summary of Motor Vehicle Findings

The following summarizes key motor vehicle findings related to the level of activity documented as well as deficiencies for this mode of travel. These findings will be utilized to help guide future improvements to address the deficiencies for this mode of travel in the transportation network.

- The functional classification of roadways found in the city of Milwaukie allows for the proper hierarchy of roadways that balances mobility and access. Currently the business industrial area south of Railroad Ave, north of Hwy 224, east of 37th Ave and west of Lake Rd has roadways without functional classification. International Way serves as an existing facility that provides connectivity within this area, and access to arterials and collectors.
- Street drainage issues appear to be located in the southeast area of the city, and are typically due to locations not being connected to the stormwater pipe system. An area of specific concern today is the area along Railroad Ave from Harmony Rd to 37th Ave.
- There is currently one study area intersection that does not meet jurisdictional operating standards: Johnson Creek Blvd/32nd Ave. Additionally, four other intersections are reaching capacity:
 - McLoughlin Blvd/Harrison St
 - McLoughlin Blvd/River Rd
 - Hwy 224/Freeman Way
 - Johnson Creek Blvd/Linwood Ave
- Many of the study intersections in Milwaukie have low reported collision rates. Two intersections have collisions of 10 or more. These are the intersections of Hwy 224/Lake Rd (which also included a fatality) and Hwy 224/Harrison St.
- The majority of heavy vehicle counts collected at study area intersections occur along major regional truck routes (such as McLoughlin Blvd and Hwy 224), however the intersection of Lake Rd/Oatfield Rd had a high number of heavy vehicles counted during the p.m. peak hour (100-150 heavy vehicles). Neither of these facilities are designated as truck routes, indicating that trucks could be utilizing these facilities as a "cut-through" route due to congestion and/or access issues on the major regional truck routes.

RAIL

There is one other mode of transportation in Milwaukie: the railway system. Figure 3-17 shows the rail facilities and crossings in Milwaukie.

There are three rail freight lines, two Union Pacific Railroad (UPRR) lines and one Oregon Pacific Railroad (OPR) line that currently traverse Milwaukie. The UPRR main line, also named the C line, is the main line between Portland and Eugene. It extends from northern Milwaukie, south and east through the city to the east and operates twenty-four freight trains a day and six Amtrak passenger trains per day with maximum authorized speeds of 45 and 50 mph, respectively. There are four at-grade railroad crossings along this line on Harrison Ave, Oak St, 37th Ave, and Harmony Ave, all of which are gated.

The UPRR Tillamook line, also known as the FD line, is leased to Portland & Western Railroad (PNWR). It extends from Portland in the north through Milwaukie and exits to the south. PNWR operates four trains per day along this line with a maximum authorized speed of 45 mph. There are twelve railroad crossings along this line, including one underpass, four overpasses, and three crossings without gates on Wren St, Bluebird St, and Bobwhite St.

The rail line operated by Oregon Pacific passes through the northwestern corner of the city of Milwaukie and has three at-grade railroad crossings, two which are without gates. These crossings without gates are at Milport Rd and McBrod Ave.

There are no airports, pipelines, ferries, or ports within Milwaukie's city limits or its UGMA.

Summary of Rail Findings

The following summarizes key findings related to other modes of travel in Milwaukie. These findings will be utilized to help guide future improvements to address the deficiencies for this mode of travel in the transportation network.

- The maximum authorized speeds within Milwaukie for many of the existing rail lines are 45-50 miles per hour. Many of the existing crossings in the city are at-grade facilities that are gated. However, there are six at-grade crossings that do not have gates. Three occur in the north Milwaukie industrial area east and west of McLoughlin Blvd, and the other three occur in the Island Station neighborhood to the south.
- Typical vertical clearance for underpasses (whether they are roadway or railway) is 14 feet.¹⁸ This is a typical clearance to allow for trucks to clear the underpass, even if they are not on a freight-classified facility. The three underpasses at Lake Rd, Sparrow St, and Lark St do not meet this typical vertical clearance.
- The traffic generated by heavy trucks cutting through neighborhoods has both real and perceived impacts on neighborhood livability, including noise, vibration, safety, aesthetics, and air quality. Accessibility issues on Hwy 224 and McLoughlin Blvd, as well as weight restrictions on Johnson Creek Blvd, cause trucks to divert onto local streets not intended or preferred for freight traffic.

¹⁸ Based on *A Policy on Geometric Design of Highways and Streets*, Fourth Edition, American Association of State Highway and Transportation Officials (AASHTO), page 389.



Transportation System Plan

FIGURE 3-17

RAIL ROUTES & CROSSINGS

November 2013

LEGEND

Rail Facilities

++++ Existing Railroad

Number of Trains Daily

Rail Crossings

At Grade - Gated

At Grade - Ungated

Road Overpass

Road Underpass

Other Map Features

Schools

Kellogg Creek Trail

Springwater Trail

Trolley Trail

Light Rail Rapid Transit

Light Rail Station

Major Roads

Streets

County Line

Water

Parks

City Limits

DKS Associates

TRANSPORTATION SOLUTIONS



0 500 1,000 2,000 3,000 4,000 Feet



PARKING

City Parking Policies

On-street parking is generally available in residential areas of Milwaukie. The Milwaukie Municipal Code includes requirements for off-street parking for both residential and commercial properties. Milwaukie's Zoning Ordinance incorporates both minimum and maximum parking requirements based on specific uses.

Downtown Milwaukie Parking

Downtown Milwaukie, the area bounded by McLoughlin Blvd, 21st Ave, Hwy 224, and Lake Rd, has parking characteristics that are different from other areas of the city. The off-street parking requirements in the Downtown Zones are the same as the rest of the city, except that no off-street parking is required in the Downtown Storefront Zone or in the Downtown Office Zone north of Washington St and east of McLoughlin Blvd. The Code also limits the development of parking facilities in the Downtown Residential and Downtown Open Space Zones.

The majority of the on-street parking in the downtown area is short-term in nature, which consists of 15-minute to 4-hour parking. The majority of the off-street parking is private surface parking serving businesses in the downtown area. Figure 3-18 illustrates the locations of on- and off-street parking. Table 3-9 summarizes the parking supply as well as the type and public/private nature of the parking.

Table 3-9 Inventory of Existing Downtown Parking

Type of Parking	Total Inventory	Percentage of Inventory
On-Street		
Short-term (4 hours or less)	366	95%
Unmarked	11	3%
ADA parking	8	2%
Subtotal	385	100%
Off-Street		
Short-term (public)	29	2%
Long-term (public)	123	9%
City employee parking	42	3%
ADA parking (public)	28	2%
Private parking garage	59	4%
Private surface parking	1,162	80%
Subtotal	1,443	100%
All Parking	1,828	100%

Source: City of Milwaukie

Data Collected: December 13, 2012

Since 1993, the City has operated a permit system to allow employees of downtown businesses to park in three to four downtown parking lots, as well as in specifically marked on-street spaces. This parking permit program includes 151 parking spaces downtown. Permits can be obtained through the City of Milwaukie for a cost of \$25 per month. All off-street public parking is available on a first-come, first-served basis only. There are no reserved spaces.

It is the City's practice to conduct regular detailed inventory and utilization studies of the parking within the downtown core area. The December 2012 utilization study found that there are many



FIGURE 3-18

DOWNTOWN PARKING

November 2013

LEGEND

Number of spaces

Short Term On Street

- 15 Minute Parking
- 1 Hour Parking
- 2 Hour - < 5 ft
- 2 Hour/Permit
- 2 Hour Parking
- 2 Hour Uncontrolled
- Loading Zone - 2 Hr
- 4 Hour Parking
- 4 Hour Uncontrolled
- 4 Hour/Permit

Public ADA Parking

- ADA On-street
- ADA Off-street

Long Term Off Street

- Public Parking
- City Pkg Permit Req
- City Employee Pkg

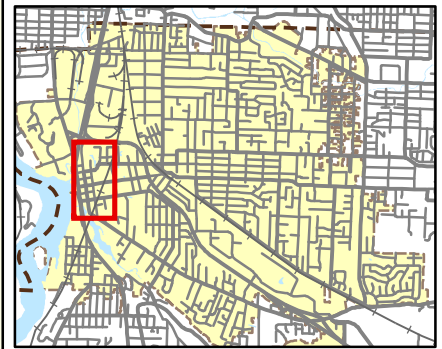
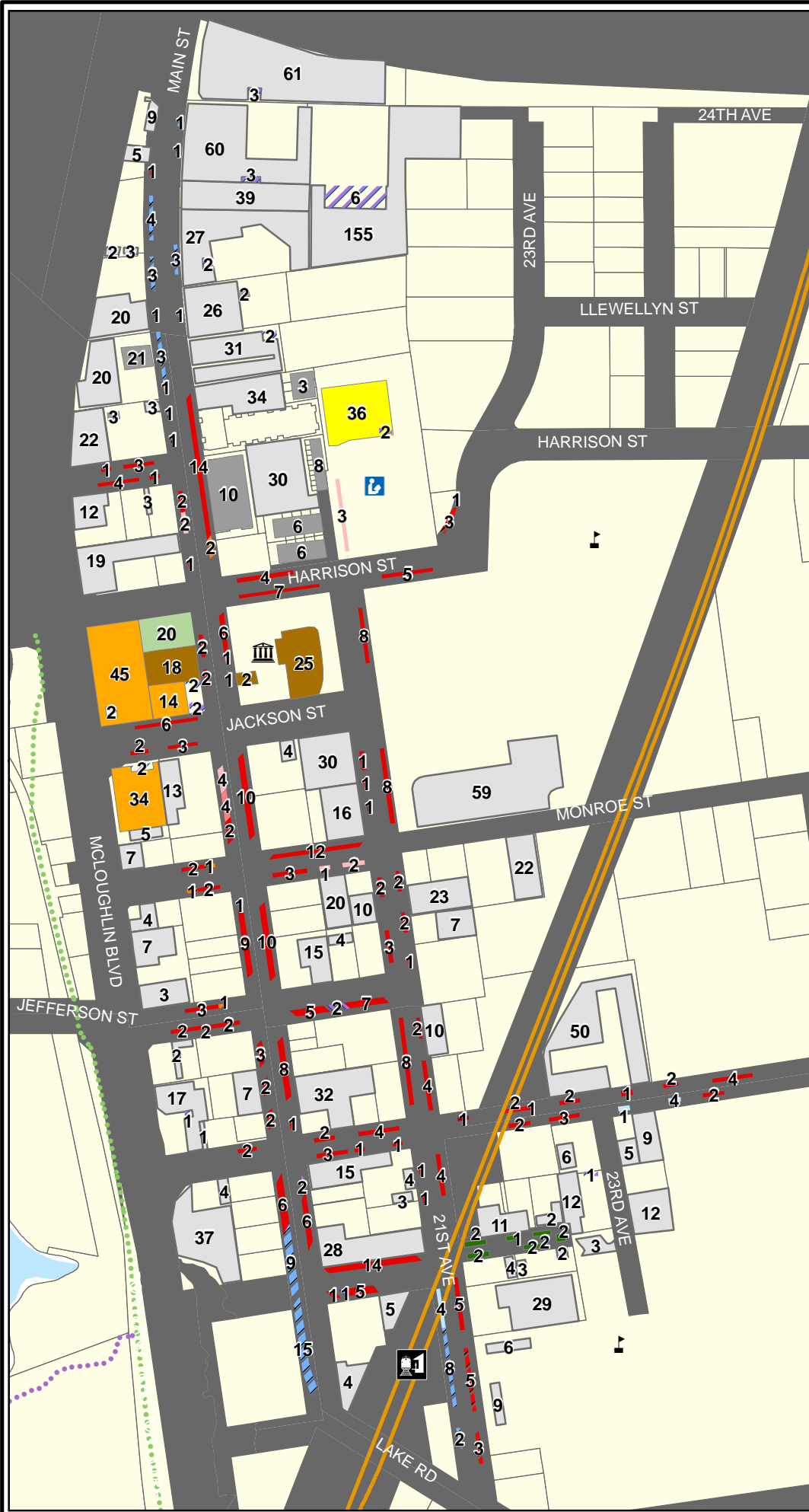
Private Lots

- Parking Garage
- Private Parking

Other

- Other Off-street
- Other On-street

- Tax lots
- Kellogg Creek Trail
- Schools
- Trolley Trail
- City Hall
- Light Rail Transit
- Ledding Library
- LRT Station



pockets of utilization in specific areas of downtown, particularly in the core commercial area along Main Street between Washington and Harrison Streets. However, there is an overall abundance of underutilized and available parking in the peak hour (11:00 a.m. to 12:00 p.m.).

As Table 3-9 indicates, the greatest concentration of underutilized parking spaces is in private lots, which represents 84% of all parking in downtown. Private lots (both surface parking and garages) comprise 1,221 total parking spaces and reach peak occupancy of just 42.0%. This leaves 708 unused spaces in the private supply.

Table 3-10 summarizes the utilization of downtown parking in December 2012.

Table 3-10 Use of Parking Spaces by Type

Type of Parking	Total Number of Spaces	Total Spaces Occupied at Peak Hour	Total Spaces Empty at Peak Hour	Peak-Hour Occupancy (%)
15 Minutes (on-street)	14	3	11	21.4
1 Hour (on-street)	4	3	1	75.0
2 Hours (on-street)	270	135	135	50.0
2 Hours, or all day with permit (on-street)	11	5	6	45.4
2-Hour loading zones (on-street)	5	0	5	0
4 Hours (on-street)	9	6	3	66.7
4 Hours, or all day with permit (on-street)	53	37	16	69.8
Unmarked (on-street)	11	9	2	81.8
ADA Spaces (on-street)	8	1	7	12.5
Subtotal On-Street	385	199	186	51.7
City permit (off-street)	87	60	27	69.0
Library/public (off-street)	65	27	38	41.5
City employee (off-street)	42	15	27	35.7
ADA spaces (off-street)	28	4	24	14.3
Subtotal Public Off-Street	222	106	116	47.7
Private lots (surface, garage)	1,221	513	708	42.0
Subtotal Private Off-Street	1,221	513	708	42.0
All Parking	1,828	818	1,010	44.7

Source: City of Milwaukie. Occupancy data was collected for the peak hour (11:00 a.m.-12:00 p.m.) on December 13, 2012.

Parking Demand

Parking ratios express the actual number of parking spaces available to serve demand for land uses (i.e., office, retail, residential, and/or mixed use development). The number of spaces represented by a parking ratio may exceed actual demand for parking or fall short of that demand. Demand ratios, on the other hand, are generally expressed in the context of peak-hour use of a specific built supply of parking. In other words, demand ratios represent an estimate of the actual number of spaces occupied at the peak hour relative to occupied land uses. Effectively managing the relationship between land uses and built and occupied parking supply is a fundamental challenge of parking management.

An understanding of actual demand also allows a city to estimate the impact of new development on an existing supply of parking. For downtown Milwaukie, two indicators help describe parking demand:

- **The actual current Built Ratio** of publicly available parking spaces, in relation to total built land uses in downtown Milwaukie.
- **The actual current Demand Ratio** for parking spaces per total built land use based on actual usage data from the most recent update of parking utilization.

Parking demand ratio calculations revealed two different, but equally useful, correlations:

- **Built Spaces to Built Land Use:** This represents the total number of existing parking spaces correlated to total existing land use square footage (occupied or vacant) within the study area. There are approximately 399,074 gross square feet of commercial uses in the Downtown Zones and a total of 1,828 parking spaces. Based on these numbers, there are approximately 4.58 parking spaces per 1,000 square feet of built land.
- **Combined Demand to Built Land Use:** This represents peak-hour occupancy within the Downtown Zones, combining the on and off-street supply (actual parked vehicles correlated with actual occupied building area). Parking spaces in downtown are utilized at a rate of 44.7% in the peak hour (818 vehicles parked). Building vacancy in downtown is approximately 11%, (approximately 355,176 of 399,074 gross square feet of building area occupied). Therefore, the actual current peak-hour demand ratio is approximately 2.3 parking spaces per 1,000 square feet of built land use.

Table 3-11 summarizes the analysis used to determine the built ratio of parking to built land use (i.e., 399,074 gross square feet) and general demand for that parking based on the peak-hour occupancy/demand for all parking inventoried in the study area.

Table 3-11 Downtown Parking Demand—Mixed Land Use to Built Supply

Sites in Downtown	Gross Square Footage (built)/ Gross Square Footage (occupied) ¹⁹	Total Spaces Inventoried in Downtown ²⁰	Built Ratio of Parking (sq ft)	Total Spaces Parked in Peak Hour	Actual Ratio of Parking Demand/ 1,000 sq ft
92	399,074/355,176	1,828	4.58/1,000 sq ft	818	2.3/1,000 sq ft

To date, parking in downtown Milwaukie has been built at an average rate of over 4.5 spaces per 1,000 square feet of development. This rate appears to have been effective, though significant stall availability currently exists within the on- and off-street parking system.

Land uses in downtown Milwaukie are generating parking demand ratios of 2.3 spaces per 1,000 gross square feet of commercial/retail development. It is important to recognize that the current parking demand number is also reflective of the current level of use by other modes (i.e., transit, bike, carpool, and walking). If the City had higher expectations and success in increasing alternative mode uses in the future, the parking "demand" ratio would be influenced downward from its current level.

¹⁹ Assumes downtown vacancy rate of 11%, per City of Milwaukie data base.

²⁰ This number represents all on-street spaces as well as public and private off-street lots in operation within the study zone and summarized in Table 3-11, above.

Summary of Parking Findings

The following summarizes key findings related to parking in Milwaukie. These findings will be utilized to help guide future improvements to address the deficiencies for this element related to the transportation environment.

- On-street parking comprises approximately 21% of the total parking supply (private and public) in the downtown area, while off-street parking comprises the remaining 79%.
- The total utilization of on-street parking in the downtown area is on average 52% throughout the day. While public off-street parking utilization is approximately 48% during the day. By comparison, the private off-street parking utilization is approximately 42% over the day.
- Parking space types with the highest utilization throughout the day are 1-hour, 4-hour, and unmarked parking spaces. All three of these types of parking are generally 65-80% occupied during the day and represent approximately 20% of the total on-street parking supply. Two-hour parking spaces are generally 50% occupied during the day.

ENVIRONMENTAL JUSTICE

As stated by the Environmental Protection Agency, "Environmental Justice is the fair treatment and meaningful involvement of all people regardless of race, color, national origin, or income with respect to the development, implementation, and enforcement of environmental laws, regulations, and policies."²¹ Within the context of the TSP, Environmental Justice is an effort to identify underserved and vulnerable populations so Milwaukie can improve transportation services while avoiding future impacts.

Figure 3-19 identifies the location of low-income housing (indicating populations most likely to be dependant on public transportation), areas of Milwaukie that are outside of the public transit coverage area, as well as the location of features such as hospitals, schools, and libraries. Transit coverage is based on comparing land that has a high enough density to support transit service versus a 1/4-mile walking distance buffer around transit stops.²² One significant gap in transit coverage area can be seen in the residential area north of Railroad Ave, stretching east/west from Stanley Ave to 42nd Ave. Other smaller gaps in transit coverage can be seen to the northeast and along the perimeter of the city.

In addition to regular public transit services, programs run by TriMet and the Milwaukie Center²³ provide transportation to senior citizens and disabled persons. The Milwaukie Center's transportation program provides four transit opportunities. Daily buses provide door-to-door service to and from the Center for lunch, shopping, and other activities. These buses have wheelchair-lift capacity, and phone-in requests are available with 24-hour notice. User fees are charged for the daily service. Rides are \$1.50 one way or \$3 per day to the Milwaukie Center. Rides are \$2 one way to the grocery store or \$4 round trip. Riders may purchase a 5-, 10-, or 20-ride card. Scholarships are available for riders who need financial assistance.

TriMet operates a fixed-route shuttle service (#152) between the Milwaukie Transit Center and Clackamas Town Center which stops at the Center. Transportation Reaching People (TRP) offers volunteer-provided services to take elderly/disabled residents for medical appointments, shopping, and personal needs. TriMet LIFT is a door-to-door transportation service for people who are unable to ride regular buses due to disability. This program targets those who are unable to use public transportation due to a disability or disabling health condition, and covers areas 3/4 of a mile past the outermost portions of TriMet's bus and light rail (MAX) services. These services are available on appointment from 4:30 am to 2:30 am, seven days a week. Cost is \$1.60 each way.

Summary of Environmental Justice Findings

The following summarizes key findings related to environmental justice in Milwaukie. These findings will be utilized to help guide future improvements to address the deficiencies for this element related to the transportation environment.

- Almost all of the facilities and/or land uses that would typically be dependent or rely upon transit/transportation facilities have support of these types of transportation facilities.
- The lack of pedestrian and bicycle connectivity within the city also contributes to the lack of transportation options for the transit dependant population in the city.

²¹ U.S. EPA, Environmental Justice, Compliance and Enforcement, Website, 2007.

²² Planning Commission TOD Committee, Walking Distance Research, http://www.fairfaxcounty.gov/planning/tod_docs/walking_distance_abstracts.pdf, Fairfax County, Virginia.

²³ <http://ncprd.com/wp-content/uploads/2011/02/transflyer.pdf>



Transportation System Plan

FIGURE 3-19

TRANSIT DISADVANTAGED

November 2013

LEGEND

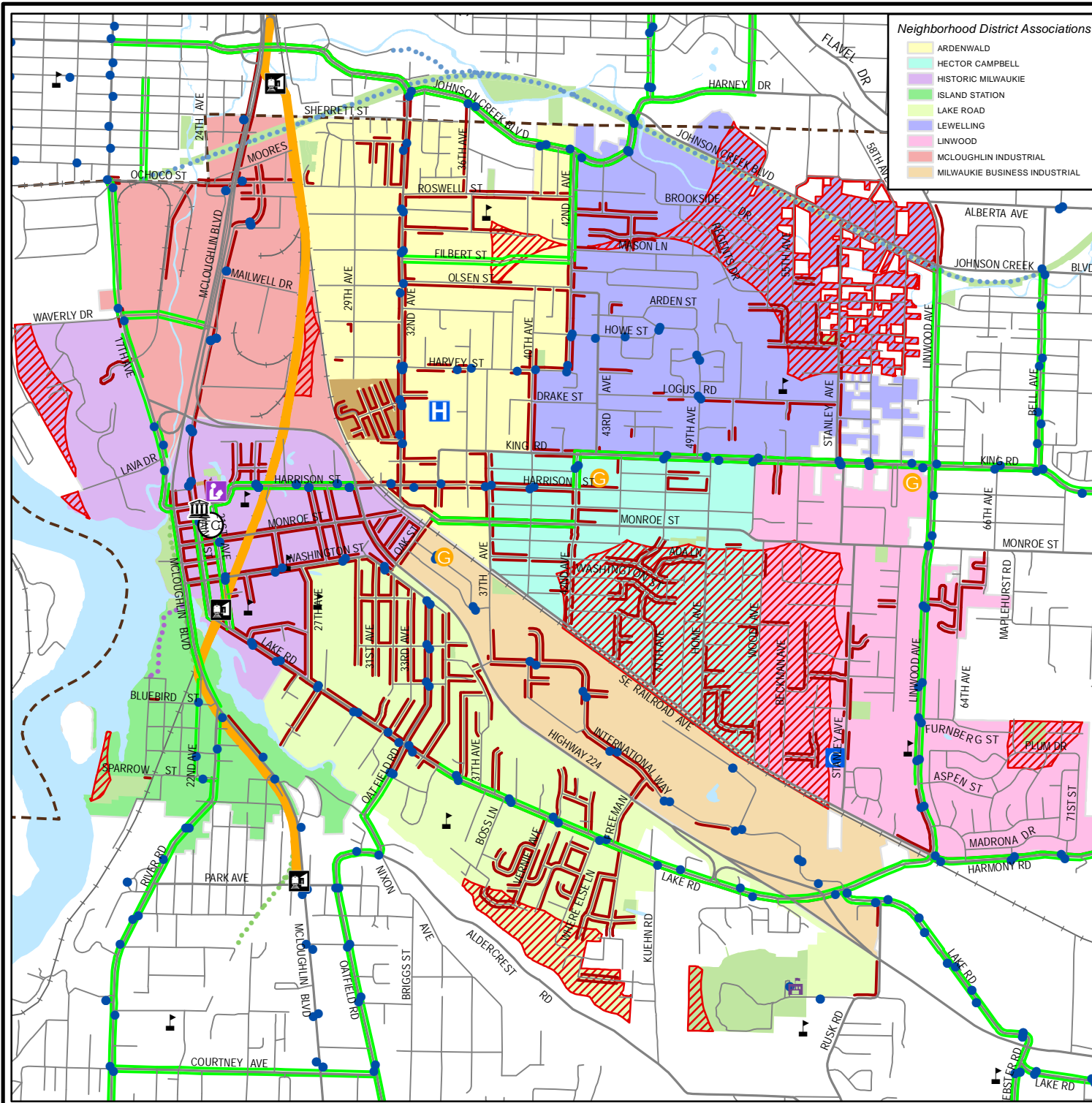
- Transit Disadvantaged (more than 1/4 mile walk from bus stop)
- Bus Stops
- Transit Center
- Light Rail Station
- Light Rail Transit
- Major Roads
- Streets
- Existing Bike Lanes
- Existing Sidewalks
- City Hall
- Convalescent Care
- Grocery
- Ledding Library
- Milwaukee Center
- Providence Hospital
- Low-Income Housing

Other Map Features

- Schools
- Kellogg Creek Trail
- Springwater Trail
- Trolley Trail
- Railroad
- County Line
- Water
- Parks

Neighborhood District Associations

- ARDENWALD
- HECTOR CAMPBELL
- HISTORIC MILWAUKIE
- ISLAND STATION
- LAKE ROAD
- LEWELLING
- LINWOOD
- MCLOUGHLIN INDUSTRIAL
- MILWAUKIE BUSINESS INDUSTRIAL



DKS Associates
TRANSPORTATION SOLUTIONS

0 500 1,000 2,000 3,000 4,000 Feet

ENVIRONMENTAL RESOURCES

As a Transportation Planning Rule (TPR) requirement, a city's transportation system shall minimize adverse economic, social, environmental, and energy consequences.²⁴ An Environmental Resources Map is included here as Figures 3-20 through 3-22; showing Title 3 areas, the local Goal 5 inventory, National Wetland Inventory, identified historic properties, and known cultural resources.

The goal of Title 3 of the Metro Functional Plan is to protect water quality and floodplain areas. Since floodplains reduce flood hazards, control soil erosion, and reduce pollution of the region's waterways, the region's health and public safety are protected. It can be seen in Figure 3-20 that there are Title 3 areas dispersed throughout the city, including bands along Johnson Creek, the Willamette River, around Kellogg Lake, and along Kellogg Creek. Many of the Title 3 areas are also encompassed by floodplain, vegetation, and wetland zones. Endangered species habitat also correlates closely with the location of the Title 3 areas.

Local jurisdictions are required by Statewide Planning Goal 5 to adopt plans to protect natural resources and conserve scenic and historic areas and open spaces. Fish and wildlife habitats are among the natural resources that are protected by Goal 5. Figure 3-21 identifies the Goal 5 areas within Milwaukie.

Summary of Environmental Resources Findings

The following summarizes key findings related to environmental resources in Milwaukie. These findings will be utilized to help guide future improvements to address the deficiencies for this element related to the transportation environment.

- The 100-year flood plain affects lands to the west of McLoughlin from Waverly Dr to Washington St, then crosses to the east side of McLoughlin Blvd from Washington St to Oatfield Rd. This is of particular concern for any potential improvements associated within this area.
- Two large wetland and wetland buffer areas have been identified. One is located on the southeast corner of 37th Ave/Railroad Ave, while the other is located on the south side of Railroad Ave near 47th Ave. When considering potential improvements in this area, the City should be cautious about impacts to these areas.

²⁴ OAR 660-012-0035, Environmental Considerations for Transportation Planning.



Transportation System Plan

FIGURE 3-20

WETLANDS, FLOOD & CULTURAL FEATURES

November 2013

LEGEND

- Historic Resource
- 100 Year Flood Plain*
- Willamette Greenway
- 1996 Flood Extent
- Wetland
- Vegetated Corridor
- 10' Contours

Other Map Features

- Schools
- Kellogg Creek Trail
- Springwater Trail
- Trolley Trail
- Major Roads
- Streets
- Railroad
- County Line
- Water
- City Limits

*Source: Metro RLIS; FEMA with local input

DKS Associates
TRANSPORTATION SOLUTIONS



0 500 1,000 2,000 3,000 4,000 Feet





Transportation System Plan

FIGURE 3-21

ENVIRONMENTAL RESOURCES - GOAL 5

November 2013

LEGEND

Goal 5 Conservation Value

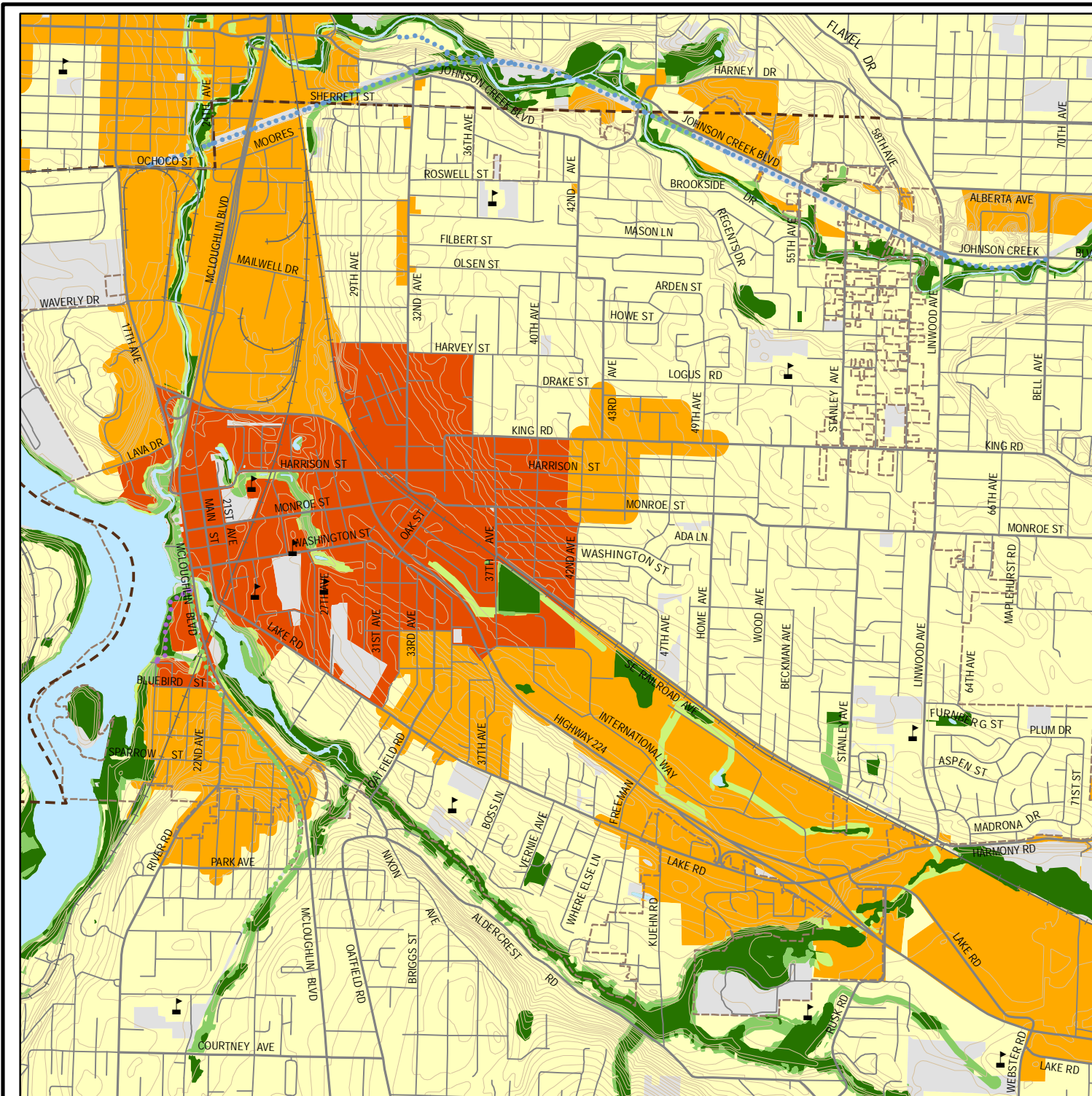
- HIGH
- MODERATE
- LOW

Goal 5 Development Value

- HIGH
- MEDIUM
- LOW
- NOT RANKED

Other Map Features

- Schools
- Kellogg Creek Trail
- Springwater Trail
- Trolley Trail
- Major Roads
- Streets
- Railroad
- County Line
- City Limits
- Water
- 10' Contours



DKS Associates
TRANSPORTATION SOLUTIONS



0 500 1,000 2,000 3,000 4,000 Feet



Transportation System Plan

FIGURE 3-22

ENVIRONMENTAL RESOURCES - ZONING & VEGETATION

November 2013

LEGEND

METRO Environmental Zone

- Conservation
- Protection

Vegetation

- High
- Medium
- Low
- Title 3

Other Map Features

- Schools
- Kellogg Creek Trail
- Springwater Trail
- Trolley Trail
- Major Roads
- Streets
- Railroad
- County Line
- Water
- City Limits
- 10' Contours



DKS Associates
TRANSPORTATION SOLUTIONS



0 500 1,000 2,000 3,000 4,000 Feet

4



Future Forecasting Process

TRAVEL DEMAND AND LAND USE

Metro's urban area transportation forecast model is used to determine future traffic volumes in Milwaukie. This forecast model translates assumed land uses into person trips, selects travel modes and assigns motor vehicles to the roadway network. These traffic volume projections form the basis for identifying potential roadway deficiencies and evaluating alternative circulation improvements. This chapter will describe the forecasting process, including key assumptions and the land use scenario developed from the existing Comprehensive Plan designations and allowed densities.

PROJECTED LAND USE GROWTH

Land use is a key factor in developing a functional transportation system. Considerations must include the amount of land to be developed, the type of land uses that will be developed, and the relationship between mixed land uses and associated demands on the transportation system.

Projected land uses developed for the study area reflect Milwaukie's Comprehensive Plan and Metro's land use assumptions for the year 2035.¹ Complete land use data sets have been developed for the following conditions.

- Existing 2010 (base travel forecast for the region).
- Future 2035 Conditions.

The following sections summarize the forecasted growth in land uses that influence travel within the City of Milwaukie.

GROWTH WITHIN MILWAUKIE

The base year travel model is updated periodically to reflect the most current and up-to-date inputs related to land use for the region. For this study, the available base model provided by Metro represents land uses for 2010. This land use database includes the number of dwelling

¹ Metro works cooperatively with local agencies to determine local existing and future land uses that incorporate existing land uses and reflects input from local agencies. These land uses are then regionally adopted and updated when new travel demand models are developed.

units (housing), retail employees, service employees, and other employees. Table 4-1 summarizes the aggregated land use data for the 2010 base and future 2035 scenarios within the study area. This land use data is divided into smaller areas called Transportation Analysis Zones (TAZs), which contain a portion of the households, retail, service and other employees. This land use creates varying trip modes such as motor vehicle, pedestrian, bicycle and transit trips.

Table 4-1 Milwaukie TSP Study Area Land Use Summary

Land Use	2010	2035	Increase	Percent Increase
Households (HH)	9,791	11,668	877	19%
Retail Employees (RET)	1,405	1,902	497	35%
Service Employees (SER)	3,860	4,943	1,083	28%
Other Employees (OTH)	6,754	7,792	1,038	15%

Source: Metro (subset of TAZ data that approximates Milwaukie city limits)

The overall operation of the transportation system is affected as land uses change. Retail land use typically generates a higher number of trips per acre of land than households and other land uses during the p.m. peak period. The location and design of retail land use in a community can greatly affect future transportation system operation. Additionally, if an area within the city is homogeneous in land use character (i.e. all employment or residential), the transportation system typically supports significant trips coming to or from the area rather than within the area. Integration of residential, commercial, and employment land uses within a small geographic area promotes sustainable livability, where residents can work, shop, and play locally. Among other significant benefits, this reduces long-distance traveling by residents who would otherwise be seeking services outside their locality.

Table 4-1 displays the projected employment growth (approximately 2,600 jobs) in Milwaukie that is projected to occur over a 25-year period. The transportation system should be monitored to make sure that land uses in the plan are balanced with transportation system needs. A primary purpose of a TSP is to determine those needs and help identify transportation projects for all modes that help balance future needs with the forecasted 2035 land uses.

Within the study area there are approximately 36 TAZs used by Metro for planning purposes. The number of TAZs in the study area has increased from 31 since the last TSP update, due to Metro's continued refinement of the regional travel demand model. The TAZ boundaries are shown in Figure 4-1.



Transportation System Plan

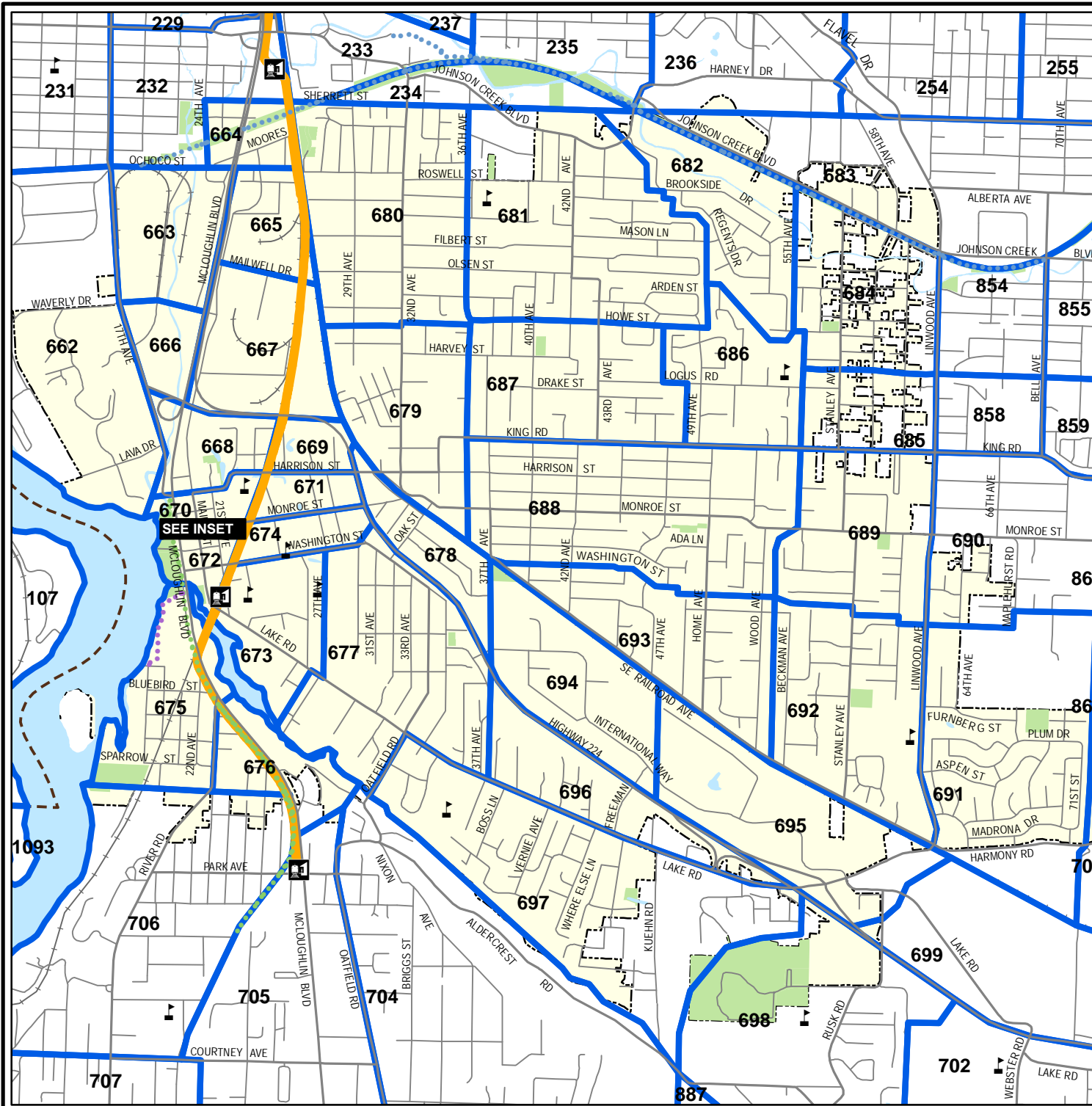
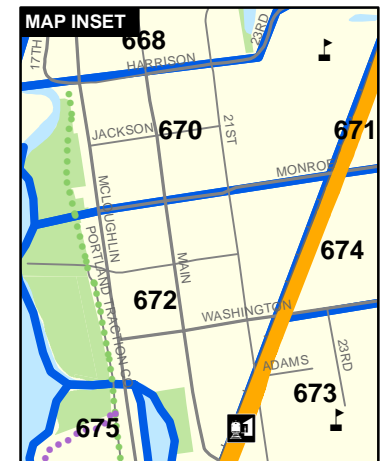
FIGURE 4-1

TRANSPORTATION ANALYSIS ZONES

November 2013

LEGEND

- Transportation Analysis Zones**
- Metro Beta Model Transportation Analysis Zones
 - ####** Transportation Analysis Zone Number
- Other Map Features**
- Schools
 - Kellogg Creek Trail
 - Springwater Trail
 - Trolley Trail
 - Light Rail Station
 - Light Rail Transit
 - Major Roads
 - Streets
 - Railroad
 - County Line
 - Water
 - Parks
 - City Limits



DKS Associates
TRANSPORTATION SOLUTIONS



0 500 1,000 2,000 3,000 4,000 Feet

METRO AREA TRANSPORTATION MODEL

Accurately forecasting travel demand of estimated future population and employment is important for determining future transportation system needs. The objective of the transportation planning process is to provide necessary information to aid decision-making of where and when transportation system improvements should be made to meet future travel demand. Metro uses VISUM, a computer-based transportation modeling program to process large amounts of data related to land use and person trips for several modes of travel for the Portland Metropolitan area. The modeling process for the Milwaukie TSP uses the 2010 and 2035 travel demand models during the 2-hour p.m. peak period to develop future forecasts within Milwaukie. These models are "Beta" versions that have been updated since the adoption of Metro's 2035 Regional Transportation Plan (RTP).²

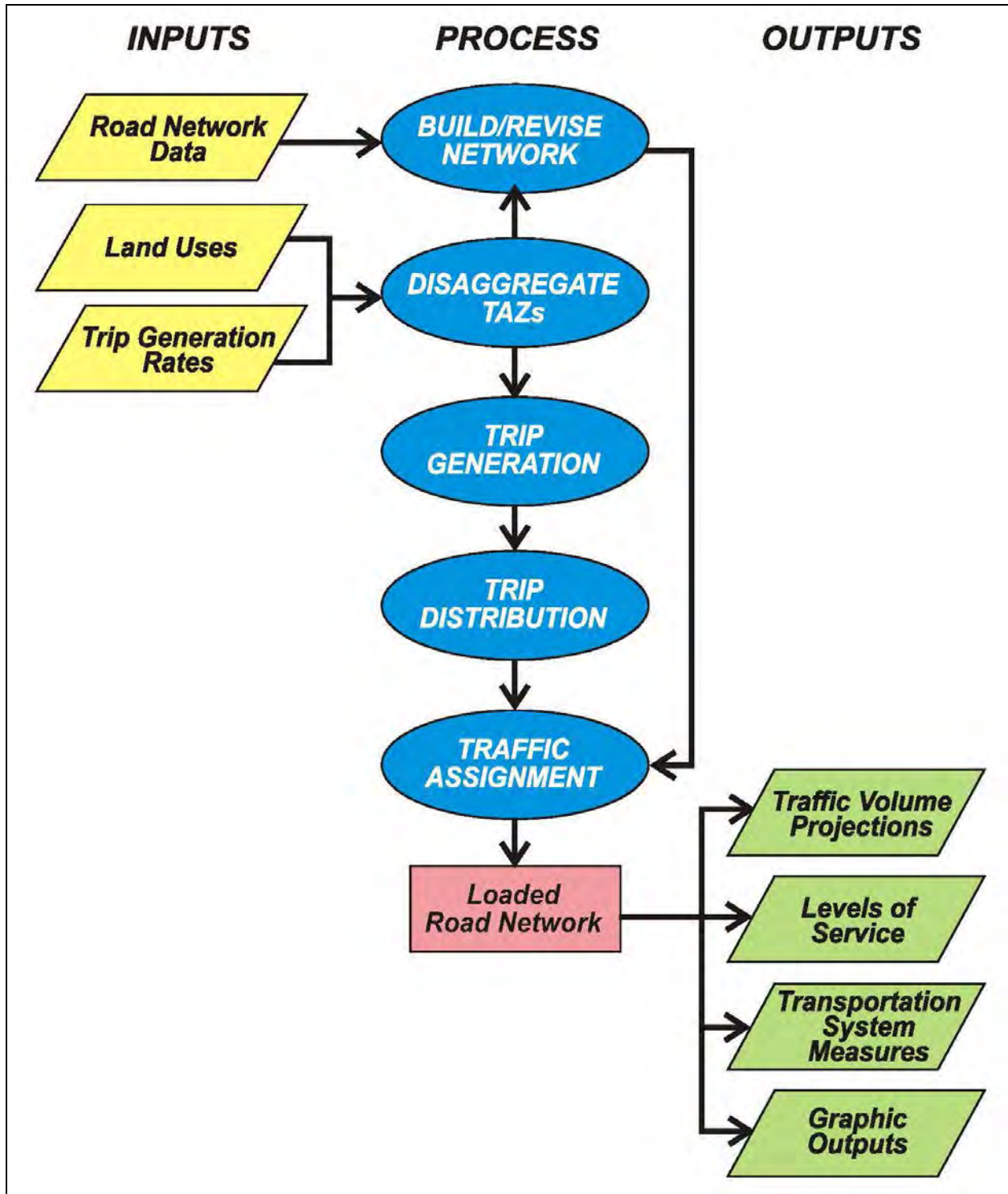
Future travel demand forecasting can be divided into several distinct, yet integrated components that represent the logical sequence of travel behavior (see Figure 4-2). These components and their general order in the traffic forecasting process are as follows:

1. **Trip Generation:** Converts land use type into total person trips.
2. **Trip Distribution:** Determines the origins and destinations within the region.
3. **Mode Choice:** Determines which mode of travel (i.e. motor vehicle, bicycle, pedestrian, transit, carpool, etc.) each trip will use.
4. **Traffic Assignment:** Assigns the trips by mode to specific routes in the transportation network that match the trip distribution locations.

The base roadway network in the existing 2010 traffic model reflects the current street and roadway system. The future 2035 roadway system in the Metro model consists of a "low build" condition that is typically consistent with the RTP financially constrained system. It includes both projects for which funding has been identified and the funded projects listed in the 2007 Milwaukie TSP. Projects in both the RTP and the TSP were then validated in the study process. Forecasts of p.m. peak period traffic flows were produced for every major roadway segment within Milwaukie. Traffic volumes were projected on all arterials and most collector streets. While most local streets are not included in the model, many are represented by TAZ connectors in the model process.

² Use of the Beta model is consistent with guidance from Metro. Memo: *Administrative Interpretation of 2035 Regional Transportation Plan, No 2012-2 – Guidance for Transportation System Plans and Corridor Plans about regional population and employment forecasts recommended for use in planning efforts in 2012*, John Williams, Metro, May 2, 2012.

Figure 4-2 Travel Forecasting Model Process



TRIP GENERATION

The trip generation process translates land use quantities (number of dwelling units, retail employees, service employees and other employees) into vehicle trip ends (number of vehicles entering or leaving a TAZ) using trip generation rates established during the model verification process. The Metro trip generation process is elaborate, entailing detailed trip characteristics for various types of housing, retail, service, other employment, and special activities. Typically, most traffic impact studies rely on the Institute of Transportation Engineers (ITE) research for analysis.³ The model process is tailored to variations in travel characteristics and activities in the region. For reference, Table 4-2 provides a summary of the approximate average evening peak-hour trip rates used in the Metro model. These are averaged over a broad area and do not account for pass-by trips; thus, they are different than driveway counts represented by ITE for similar land uses. This data provides a reference for the trip generation process used in the model.

Table 4-2 Approximate Average P.M. Peak Period Trip Rates Used in Metro Model

Unit	Average Trip Rate/Unit		
	In	Out	Total
Household (HH)	0.69	0.35	1.04
Retail Employee (RET)	0.89	1.23	2.12
Service Employee (SER)	0.19	0.47	0.66
Other Employee (OTH)	0.13	0.39	0.52

Source: DKS Associates/Metro Regional Travel Demand Model

Table 4-3 summarizes the total estimated 2010 and 2035 motor vehicle trips for Milwaukie as well as the estimated growth in vehicle trips during the two-hour p.m. peak period. Using the forecasted land use and calculated trip rate values, the total number of in- and out-trips can be produced for each TAZ in the region. Vehicle trips in Milwaukie are expected to grow by approximately 16% between 2010 and 2035 if the land develops according to the 2035 land use assumptions. Assuming a 25-year horizon to the 2035 scenario, this represents annualized growth rate of approximately 0.61% per year.

Table 4-3 Milwaukie Vehicle Trip Generation (2-Hour P.M. Peak Period)

	2010 Trips	2035 Trips	Percent Increase
Milwaukie TSP update Study Area	21,328	24,816	16%

Source: Metro Regional Travel Demand Model

TRIP DISTRIBUTION

This step estimates how many trips travel from one area in the model to any other area. Distribution is based on the number of trip ends generated in each TAZ zone pair, and on factors that relate the likelihood of travel between any two TAZs to the travel time between the zones.

³ *Trip Generation Manual*, 7th Edition, Institute of Transportation Engineers, 2003.

In projecting long-range future traffic volumes, it is important to consider potential changes in regional travel patterns. Although the location and amount of traffic generation in Milwaukie are essentially a function of future land use in the city, the distribution of trips is influenced by expected congestion on roadways and regional growth, particularly in neighboring areas such as Portland, Oregon City, and the unincorporated Clackamas County areas. The model and trip distribution can also be used to help define the number of internal, external, and through trips for Milwaukie. These types of trips are as follows:

- **Internal trips** are trips that start and end within the city limits of Milwaukie.
- **External trips** are trips that either start in Milwaukie and end outside the city, or start outside the city and end within the city.
- **Through trips** are trips that pass through Milwaukie and have neither an origin nor a destination in Milwaukie.

Table 4-4 quantifies the internal, external, and through trips for all roadways within Milwaukie, as forecasted by the Metro regional travel demand model for 2010 and 2035. The number of internal versus external or through trips reveals that few people actually both live and work in Milwaukie. The much larger number of external than internal trips represents the people who live outside of Milwaukie and work in the city, or live in Milwaukie but work outside of the city. The high number of through trips through the city indicates that Milwaukie functions as a conduit for a significant number of people between their jobs and homes, both of which are outside the city limits of Milwaukie. Comparing the percentage of trips for the model year 2035 versus 2010 shows there is a slight decrease (2%) in the percentage of external trips during the p.m. peak period. It also shows that the percentage of through trips slightly increases over the 25-year time span.

Table 4-4 Milwaukie Vehicle Trip Distribution (2-Hour P.M. Peak Period)

Trip Type	2010	2035	% Change
Internal Trips (I-I)	10%	10%	0%
External Trips (X-I or I-X)	51%	49%	-2%
Through Trips (X-X)	39%	41%	+2%

Source: DKS Associates/Metro Regional Travel Demand Model

I = Internal location
X = External location

MODE CHOICE

This step in the modeling process determines how many trips will be made by various modes (single-occupant vehicle, transit, carpool, pedestrian, bicycle, etc.). The 2010 mode splits are incorporated into the base model and adjustments to that mode split may be made for a future scenario dependant upon any anticipated changes in transit or carpool use. These considerations are built into the forecasts used for 2035. Based upon analysis of the forecasted mode choice in 2035, a study was performed to determine the level of non-single-occupant-vehicle (non-SOV) mode share. The travel model provides estimates of the various modes of travel that can be generally assessed at the transportation analysis zone level. Figure 4-3 summarizes the level of non-SOV mode share estimated for 2035 using the regional travel demand forecast model in comparison to the modal targets established in the RTP through Table 1-3 of the 2008 RTP. Generally, the areas served by transit service have the highest levels of non-SOV mode choice. The targets are based on the 2040 design type for areas around the region, as follows for each design type and non-SOV target:

- Portland Central City (60-70%).
- Regional Centers, Town Centers, Main Streets, Station Communities, Corridors, Passenger Intermodal Facilities (45-55%).
- Industrial Areas, Freight Intermodal Facilities, Employment Areas, Inner Neighborhoods, Outer Neighborhoods (40-45%).

These non-SOV targets are aggregated by design type groupings (as listed above) and colored in Figure 4-3 as orange (45-55% target) and yellow (40-45% target). For each TAZ, the 2035 non-SOV share is listed. In general, the change from year 2010 is 2% growth or less. The 2035 non-SOV share for each TAZ is also colored to indicate the highest target that is satisfied (orange for 45-55% target, and yellow for 40-45% target). Note that TAZ boundaries, which are the basis for the non-SOV share data, do not directly align with the 2040 design type boundaries.

Generally, the areas served by transit service have the highest levels of non-SOV mode choice.

TRAFFIC ASSIGNMENT

In this process, trips from one zone to another are assigned to specific travel routes in the network, and resulting trip volumes are accumulated on links of the network until all trips are assigned.

Network travel times are updated to reflect the congestion effects of the traffic assigned through an equilibrium process. Congested travel times are estimated using what are called "volume-delay functions" in VISUM. There are different forms of volume-delay functions, all of which attempt to simulate the impact of congestion on travel times (greater delay) as traffic volume increases. The volume-delay functions take into account the specific characteristics of each roadway link, such as capacity, speed, and facility type. This allows the model to reflect conditions somewhat similar to driver behavior.

MODEL VERIFICATION

The base 2010 traffic volumes from the regional model were compared against actual traffic volume counts at specific locations on key arterials and at key intersections. These key intersections and corridors created "screenlines" (imaginary lines drawn across the transportation system that intersect many roadways). The screenlines are used to back-check the actual volume against the model volume to make sure that the model is predicting traffic volumes and travel patterns that reflect actual existing conditions. Most arterial traffic volumes meet screenline tolerances for forecast adequacy.⁴ If roadways and/or intersection volumes are not within this tolerance, modifications to the roadway network in the base model are made to help adjust and calibrate the model to bring those volumes to within acceptable tolerance levels. These same changes in the base model are made to the future model if those changes do not conflict with a planned project in the future model (e.g., a roadway being widened or improved). Based on this performance, the existing and future models are used for future forecasting and assessment of circulation change.

⁴ Typically within a 10% variance.

MODEL APPLICATION TO MILWAUKIE

Intersection turn movements were extracted from the model at study area intersections for both the base year 2010 and forecast year 2035 scenarios. A "post processing" technique⁵ is utilized to refine model travel forecasts to the volume forecasts utilized for 2035 intersection analysis. "Post processing" is a technique that uses existing traffic count data, base year model data, and future year model data to estimate future volumes by adding the increment of future traffic volume growth to the existing count data. This approach minimizes the effects of any model error by adding the increment of growth projected based on changes in land use to the base year counts.

⁵ National Cooperative Highway Research Program (NCHRP) 255, Highway Traffic Data for Urbanized Area Project Planning and Design, Transportation Research Board, Washington DC, 1982.

5

Pedestrian Element



Walking is the most affordable and accessible of all transportation modes. It is also clean, low-impact, and healthy for the individual. A safe and comfortable pedestrian environment allows people of all ages and abilities to travel independently. This chapter summarizes strategies used in evaluating the future needs of the city of Milwaukie's pedestrian network, recommends improvements for the network, outlines pedestrian needs for the next 22 years, and identifies projects that address the city's needs.

GOALS AND POLICIES

Milwaukie has developed a set of goals to guide the development of its transportation system (see Chapter 2). Listed below are the specific TSP Goals that guide the City's policies on pedestrian access and connectivity:

- **Goal 1 Livability** guides the City to provide convenient, accessible and coordinated pedestrian facilities and to minimize barriers to pedestrian travel.
- **Goal 2 Safety** calls for the design and maintenance of safe and accessible walkways.
- **Goal 3 Provide Travel Choices** directs the City to provide an integrated network of walkways that connect people with transit.
- **Goal 4 Quality Design** calls for pedestrian facilities to be integrated with street and development planning in a context-sensitive manner.
- **Goal 5 Reliability and Mobility** calls for enhanced connectivity, which particularly benefits pedestrians.
- **Goal 6 Sustainability** guides the City to increase the use of walking as a low-impact form of travel.

NEEDS

There are generally three different types of pedestrian trips: residential, service, and recreational trips. The deficiencies in Milwaukie's pedestrian system affect each group differently, but common to all three are the needs for connectivity, access and safety. The most common overall need is to provide a safe and interconnected system that makes pedestrian travel a viable option, especially for residential trips less than 1/2 mile in length and recreational trips less than one mile in length.

Facilities

Throughout Milwaukie, pedestrian facilities are generally deficient. Although some arterial and collector streets in the city provide limited sidewalks as shown in Figure 3-2, the north and east areas have many collectors and arterials lacking sidewalks. Many of the neighborhood and local streets throughout the city do not have pedestrian facilities. The perimeter of the city is well-served by three off-street multiuse paths, the Springwater Trail, Kellogg Creek Trail into Riverfront Park, and Trolley Trail, though gaps in the trail network exist to the east and south. Improvements are needed throughout the city, but especially on key connecting corridors that link neighborhoods to schools, parks, and commercial centers.

The Portland-Milwaukie Light Rail (PMLR) project, which is currently under construction, is building new sidewalks and pedestrian crossings around the new station in the south downtown area and will also significantly improve pedestrian facilities at the new station areas at Tacoma St and Park Ave.

City policy directs most development to fill in sidewalk gaps directly adjacent to new development. There is currently no policy to allow development to fill gaps in the pedestrian network if the gap is not adjacent to the developing site. The City should explore a different policy to collect fees from new development to help improve connections and crossings that may not be adjacent to the developing parcel.

Connectivity

Milwaukie's pedestrian network is disconnected, largely due to the lack of convenient crossings of large regional facilities: Hwy 99E, Hwy 224, and the Union Pacific Railroad. The wide design and high vehicle speeds of these roadways result in potentially unsafe and unpleasant pedestrian crossings. Without direct connections across these barriers, pedestrians are forced to travel out of direction and sometimes use busy arterial and collector streets to meet their destinations. Even where pedestrian crossings do exist, many are deficient. The use of asphalt on railroad crossings is a concern for pedestrians, since asphalt is more likely to buckle than concrete and results in uneven walking surfaces. Uneven walking surfaces are particularly problematic for elderly and disabled individuals. Numerous dead-end and curvilinear streets throughout the city also contribute to the disconnected pedestrian network. Connectivity improvements are needed in two key areas: (1) crossing improvements at most highways, railroads, and arterials,¹ and (2) connections to schools, parks, and transit routes.

FACILITIES

The most common type of pedestrian facility is a concrete sidewalk that is separated from the roadway by an extruded curb. Sidewalks must be built to current City of Milwaukie design standards and comply with the Americans with Disabilities Act, which requires at least 4 ft of unobstructed sidewalk.² Wider sidewalks are desirable to promote pedestrian travel on all roadways.

Some of Milwaukie's streets are not only important local connections, but are also designated as regionally important pedestrian streets. Streets identified in the Metro 2004 RTP as transit/mixed use corridors (streets in downtown Milwaukie, 17th Ave, Harrison St, King Rd, and 32nd Ave) are areas that are served by quality transit service and will generate substantial pedestrian traffic near neighborhood-oriented retail development, schools, parks, and bus stops.

¹ Any potential new crossing location would need to meet Oregon Department of Transportation (ODOT) crossing guidelines and criteria to make sure the crossing is warranted and safe.

² *Americans with Disabilities Act*, Uniform Building Code.

These corridors should include such pedestrian design features as wide sidewalks with buffering from traffic, pedestrian-scale lighting, benches, bus shelters, and street trees.

Milwaukie has three identified off-street multiuse paths in the Metro RTP regional trails and greenways system: the Springwater Trail, the Trolley Trail, and the Kellogg Creek greenway. The majority of the Springwater Trail within the city has been constructed. However, there is a gap between the Milwaukie section of the Springwater Trail and the section along the east bank of the Willamette River. The Trolley Trail, a project led by the North Clackamas Parks District, is currently under construction. The final segment of the Trolley Trail within the city will be completed in conjunction with the PMLR project. These facilities will be designed and built according to regional standards, as well as local jurisdictional standards.

RECOMMENDATIONS

Strategies

Milwaukie's pedestrian system is challenged by an incomplete arterial/collector sidewalk system, a lack of local street connectivity, arterial crossings with potential safety and connectivity issues, and a lack of complete multiuse trails (see Chapter 3).

The City has several strategies for addressing pedestrian system needs and guiding project prioritization. The prioritization process helps to focus community investment on those projects that are most effective at addressing critical needs, while deferring other projects of lesser importance. The strategies for pedestrian facilities include:

- Key pedestrian corridors to connect neighborhoods with schools, parks, activity centers, and major transit stops.
- Arterial crossing and safety enhancements.
- Fill gaps in the network where some sidewalks exist.
- Pedestrian corridors that connect to major recreational uses.
- Enforcement of laws that protect pedestrians.
- Education about pedestrian safety and available walking routes.

These strategies would be implemented by projects that address needs and deficiencies. The projects fall into three categories:

- **Capital:** projects that require construction of some sort of physical infrastructure. Capital projects typically require ongoing maintenance that must be programmed into the maintenance schedule.
- **Operational:** projects which involve actions that make the existing transportation infrastructure more useable. They can include upkeep of existing facilities, educational campaigns, or distributing information about the use of the transportation network. They are typically smaller in scale and dollars than capital projects, and are implemented more broadly than in one specific location.
- **Policy:** Projects that improve the pedestrian environment that typically do not result in a physical improvement, but rather in a fundamental change in the way pedestrian travel is perceived or treated within Milwaukie. Proposed policy projects are listed below.
 - Ensure overhanging vegetation and other sidewalk obstructions are removed; ensure sidewalk safety hazards are repaired.

- Enforce speeding laws, utilizing tools such as photo radar, to make the streets generally safer; enforce laws related to pedestrian crossings and crosswalks.
- Utilize safe routes to schools programs and resources to increase pedestrian safety around schools.
- Support mixed-use development and services near residential areas to encourage walking; reexamine vehicle-centered policies, such as high amounts of required parking.
- Construct sidewalks or appropriate walkways everywhere; i.e., complete streets as development occurs or capital funds become available.
- Educate the general public about pedestrian safety; inform the general public about traffic laws related to pedestrians.

Master Plan

The Pedestrian Master Plan includes a list of projects that could address system needs and achieve the strategies for improving the pedestrian system (see Figure 5-1a). An inset map showing more detail in the downtown area is provided in Figure 5-1b. Some projects from the master plan were selected for inclusion in a Pedestrian Action Plan, which consists of projects that the community has identified for the City to give priority in allocating funding and/or pursuing additional funding. As development occurs, streets are rebuilt, and as other opportunities (grant programs) arise, projects on the master plan should be pursued as well.

The planning-level cost estimates provided for each project in Table 5-1 are based on general unit costs for transportation improvements but do not reflect the unique project elements that can significantly add to project costs. For each of these projects, the City will refine the cost estimate to include right-of-way requirements and costs associated with special design details.



Transportation System Plan

FIGURE 5-1a

PEDESTRIAN MASTER PLAN

April 2015

LEGEND

Existing Sidewalks		Proposed Improvement	
	< 5 ft width		Pedestrian Intersection Safety Improvement
	5 ft - 10 ft width		Pedestrian Facilities
	Kellogg Creek Trail		Central Milwaukie 2015 TSP Amendments
	Springwater Trail		
	Trolley Trail		
	Schools		County Line
	Major Roads		City Limits
	Streets		Light Rail Transit
	Railroad		Water
			Parks
			Light Rail Station

PROPOSED PROJECTS

Improve Intersection to Increase Pedestrian Safety

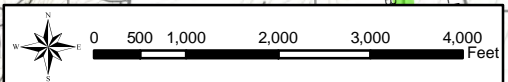
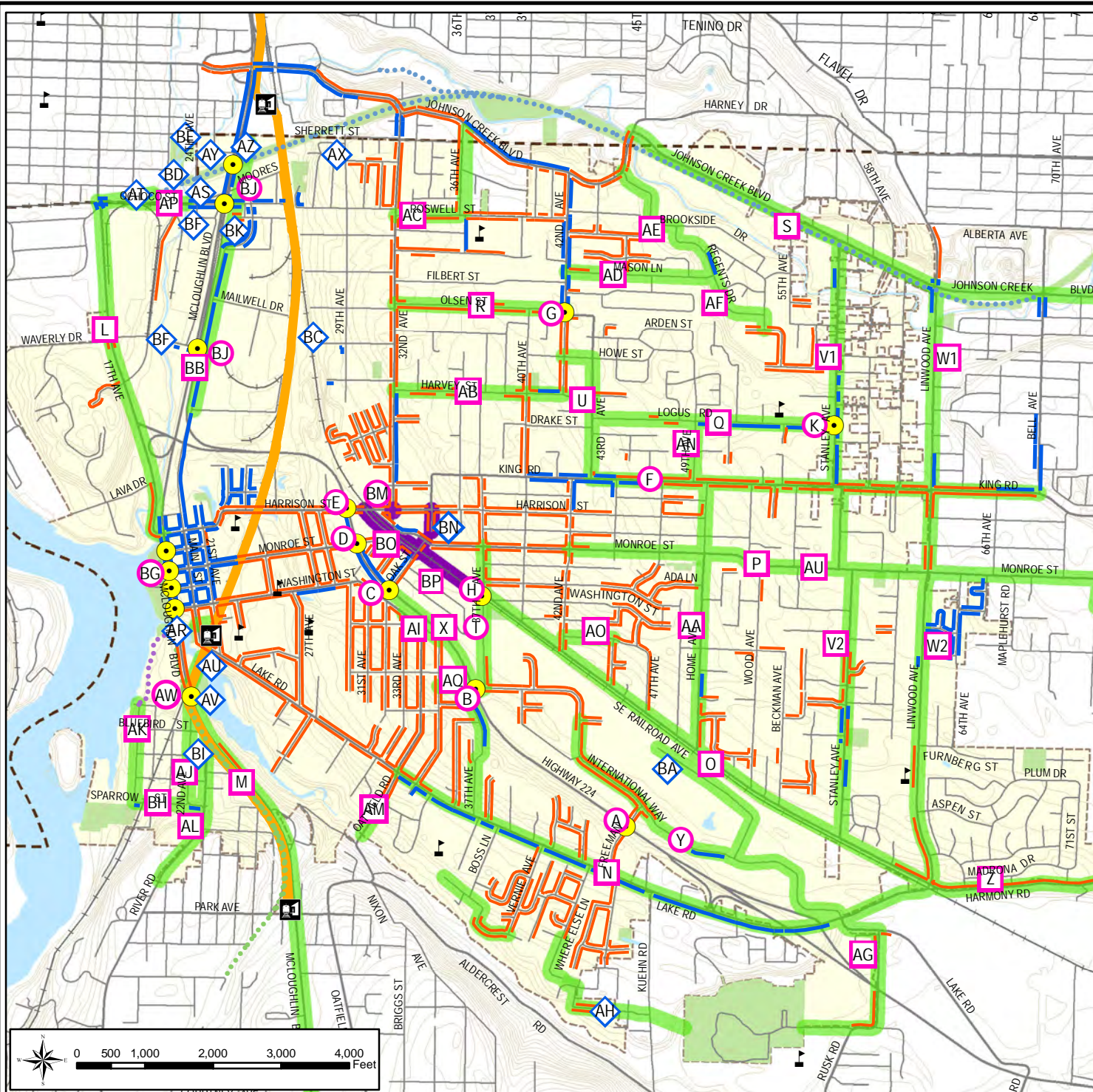
- A Freeman Way/HWY 224
- B 37th Ave/HWY 224
- C Oak St/HWY 224
- D Monroe St/HWY 224
- E Harrison St/HWY 224
- F King Rd improvements
- G Olsen St/42nd Ave
- H Railroad Ave/37th Ave
- K Stanley Ave/Logus Rd
- AW McLoughlin Blvd and 22nd Ave
- BC All McLoughlin crossings
- BJ McLoughlin and Ochoco/Milport

Provide Pedestrian Facilities Where Not Currently Present
See Table 5-1 for project descriptions L-AG, AI-AQ, BB, BH

Enhance Existing Pedestrian Connection

- AI Create ped connection from Rowe Middle School to North Clackamas Park
- AR Construct pedestrian underpass under HWY 99E at Kellogg Creek
- AT Complete Springwater Trail along Ochoco St
- AU Construct bike-ped overpass over Kellogg Creek
- AV Construct Kronberg Park Trail
- AX Pave connection to Springwater Trail at 29th Ave and Sherrett
- AY Improve connection from Springwater Corridor to Pendleton Site
- AZ Construct stairs to connect Springwater Corridor to LRT Station
- BA Establish bike-ped connection across Railroad Ave and tracks
- BC Establish bike-ped connection over railroad tracks and LRT
- BD Construct stairs from Springwater Corridor to McLoughlin Blvd
- BE Construct bike-ped bridge over Johnson Creek along Clatsop St at 23rd Ave to connect to LRT station
- BF Improve bike-ped connection to neighborhoods west of station
- BI Establish bike-ped connection over McLoughlin at River Rd
- BK Establish bike-ped connection to McLoughlin at Stubb St

Provide Improved Pedestrian Facilities in Central Milwaukie
See Table 5-1 for project descriptions BM, BN, BO, and BP





Transportation System Plan

FIGURE 5-1b

PEDESTRIAN MASTER PLAN DOWNTOWN INSET

November 2013

LEGEND

Existing Sidewalks

< 5 ft width

5 ft - 10 ft width

Kellogg Creek Trail

Trolley Trail

Proposed Improvement



Pedestrian Intersection Safety Improvement



Pedestrian Facilities

PROPOSED PROJECTS

Improve Intersection to Increase Pedestrian Safety

AW McLoughlin Blvd and 22nd Ave

BG All McLoughlin crossings

Enhance Existing Pedestrian Connection

AR Construct pedestrian underpass under HWY 99E at Kellogg Creek

AU Construct bike-ped overpass over Kellogg Creek

AV Construct Kronberg Park Trail

Other Map Features



Schools



City Hall



Ledding Library



Light Rail Station

Streets

Major Roads

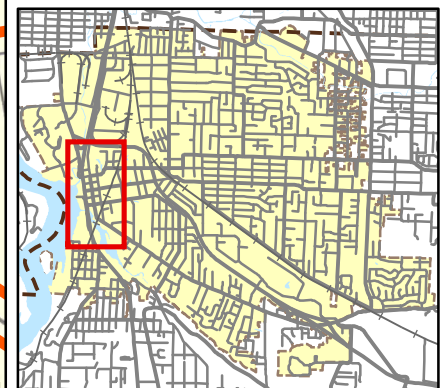
Railroad

10' Contours

Water

Parks

Light Rail Transit



DKS Associates

TRANSPORTATION SOLUTIONS

0 75 150 300 450 600 Feet

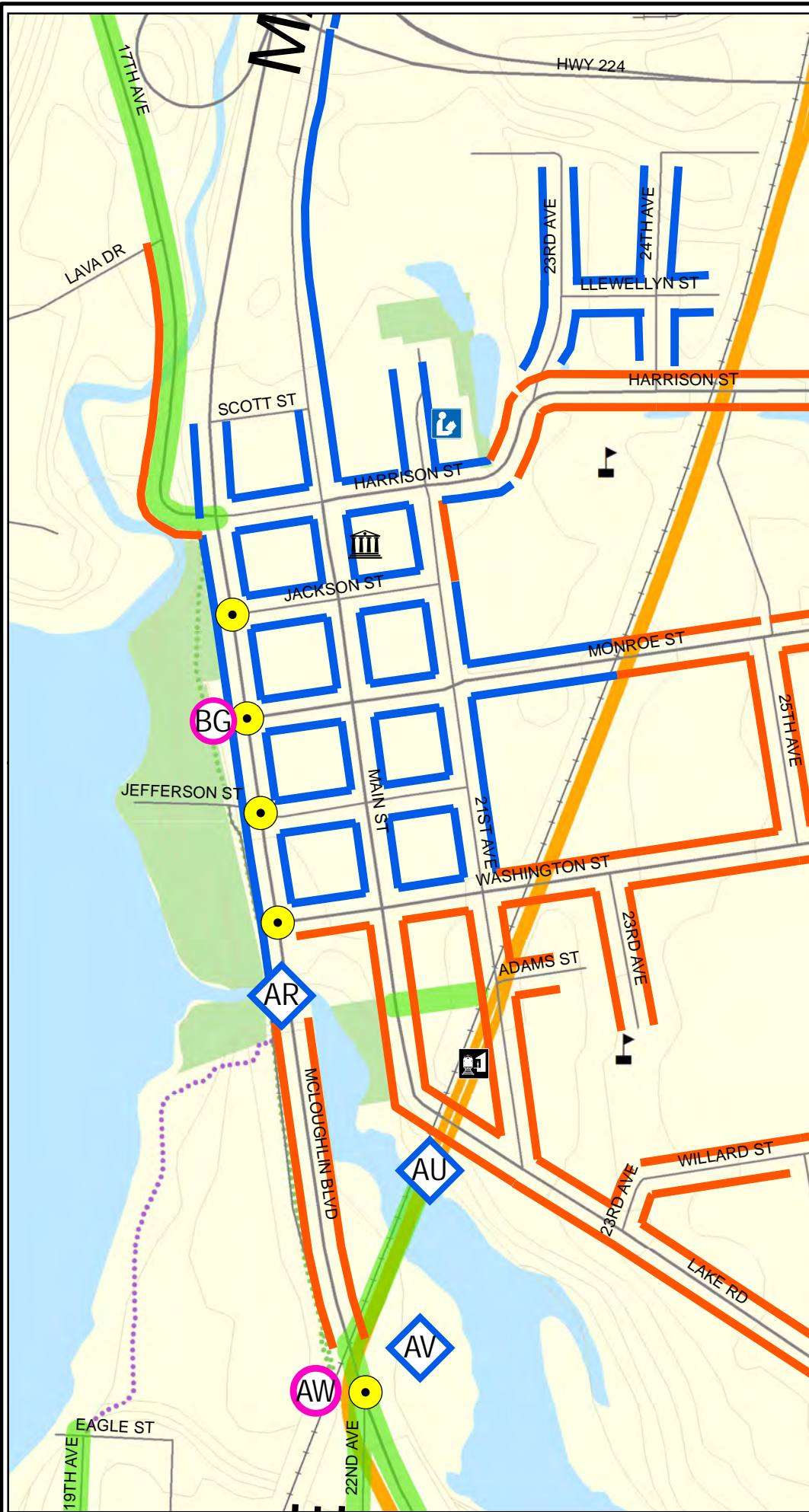


Table 5-1 Pedestrian Master Plan Projects

Map ID ³	Priority	Type	Project Name	Project Description ⁴	From	To	Cost (\$1,000s ⁵)
High Priority Projects							
N/A	High	P	Study of Pedestrian Crossings on Hwy 224	Examine alternatives for improving pedestrian crossings at five intersections along Hwy 224 (Harrison St, Monroe St, Oak St, 37 th Ave, Freeman Way)	Harrison St	Freeman Way	\$50
A	High	C	Intersection Improvements at Hwy 224 and Freeman Way	Improve pedestrian crossing.	Location-specific	Location-specific	\$20
B	High	C	Intersection Improvements at Hwy 224 and 37 th Ave	Improve pedestrian crossing.	Location-specific	Location-specific	\$20
C	High	C	Intersection Improvements at Hwy 224 and Oak St	Improve pedestrian crossing.	Location-specific	Location-specific	\$20
D	High	C	Intersection Improvements at Hwy 224 and Monroe St	Improve pedestrian crossing.	Location-specific	Location-specific	\$20
E	High	C	Intersection Improvements at Hwy 224 and Harrison St	Improve pedestrian crossing.	Location-specific	Location-specific	\$20
L	High	C	17 th Ave Improvements	Fill in sidewalk gaps on both sides of street; fill in gaps in existing bicycle network with bike lanes; and/or provide multiuse path. Improve intersection safety at Milport Rd, McBrod Ave, Hwy 224, Lava Dr, and Hwy 99E.	Ochoco St	McLoughlin Blvd	\$1,000
O	High	C	Railroad Ave Capacity Improvements	Pedestrian aspect: Fill in sidewalk gaps on both sides of street or construct multiuse path on one side.	37 th Ave	Harmony Rd	\$1,800

³ See Figure 5-1.

⁴ The projects in this table assume traditional sidewalks on both sides of the street. In some cases it may be appropriate to construct a nontraditional pedestrian facility on one side of the street. See Chapter 10 Street Design for more information on the City's approach to designing pedestrian facilities.

⁵ Project costs are order-of-magnitude estimates and are in 2012 dollars. Future costs may be more due to inflation. In the case of operational projects, estimated costs are for the entire 22-year planning period.

Map ID ³	Priority	Type	Project Name	Project Description ⁴	From	To	Cost (\$1,000s ⁵)
P	High	C	Monroe St Neighborhood Greenway	Fill in sidewalk gaps on both sides of street.	42 nd Ave	City limit	\$1,800
U	High	C	43 rd Ave Sidewalks	Fill in sidewalk gaps on both sides of street.	Howe St/42 nd Ave	King Rd/43 rd Ave	\$600
V1	High	C	Stanley Ave Neighborhood Greenway (north)	Fill in sidewalk gaps on both sides of street.	Johnson Creek Blvd	King Rd	\$1,900
V2	High	C	Stanley Ave Neighborhood Greenway (south)	Fill in sidewalk gaps on both sides of street.	King Rd	Railroad Ave	\$2,800
W2	High	C	Linwood Ave Sidewalks (south)	Fill in sidewalk gaps on both sides of street (part of Linwood Ave road-widening project).	King Rd	Railroad Ave	\$2,150
Y	High	C	International Way Sidewalks	Fill in sidewalk gaps on both sides of street.	Criterion Ct	Lake Rd	\$840
Z	High	C	Harmony Rd Sidewalks	Fill in sidewalk gaps on both sides of street.	Linwood Ave	City limits	\$40
AL	High	C	River Rd Sidewalks	Fill in sidewalk gaps on both sides of street.	McLoughlin Blvd	City limits	\$690
AR	High	C	Kellogg Creek Dam Removal and Hwy 99E Underpass	Replace Hwy 99E bridge over Kellogg Creek, remove dam, restore habitat. Construct bike/ped undercrossing between downtown Milwaukie and Riverfront Park.	Location-specific	Location-specific	\$9,900
AU	High	C	Kellogg Creek Bike/Ped Bridge	Construct bike/ped overpass over Kellogg Creek in conjunction with light rail bridge.	Lake Rd	Kronberg Park	\$2,500
AV	High	C	Kronberg Park Trail	Construct multiuse path to connect bike/ped bridge to safe crossing of Hwy 99E.	Kellogg Creek Bridge	River Rd	\$300
AW	High	C	Intersection Improvements at McLoughlin Blvd and 22 nd Ave	Improve safety of Trolley Trail crossing at 22 nd Ave.	Location-specific	Location-specific	\$200
AX	High	C	Improved Connection to Springwater Trail at 29 th Ave and Sherrett St	Pave the connection to Springwater Trail at 29 th Ave and Sherrett St. (TSAP)	Location-specific	Location-specific	\$20
AY	High	C	Improved Connection from Springwater Trail to Pendleton Site (Ramps)	Construct ramps to improve existing connection of Springwater Trail to Pendleton site at Clatsop St. (TSAP)	Location-specific	Location-specific	\$630

Map ID ³	Priority	Type	Project Name	Project Description ⁴	From	To	Cost (\$1,000s ⁵)
AY	High	C	Improved Connection from Springwater Trail to Pendleton Site (Widened Undercrossing)	Widen existing undercrossing to improve connection of Springwater Trail to Pendleton site at Clatsop St. (TSAP)	Location-specific	Location-specific	\$100
AZ	High	C	Improved Connection from Springwater Trail to Tacoma Station	Construct stairs to connect Springwater Trail to Tacoma station. (TSAP)	Location-specific	Location-specific	\$80
BL	High	C	Adams St Connector	Construct pedestrian- and bicycle-only facility on Adams St between 21 st Ave and Main St	21 st Ave	Main St	\$450
N/A	High	C	Intersection Curb Ramp Improvements	Install curb ramps at all intersections with sidewalks (approximately 700 intersections).	Citywide	Citywide	\$3,500
Medium Priority Projects							
F	Med	C	King Rd Blvd Treatments	Install street boulevard treatments: widen sidewalks and improve multiple crossings.	43 rd Ave	Linwood Ave	\$550
M	Med	C	McLoughlin Blvd Sidewalks	Fill in sidewalk gaps on both sides of street.	Washington St	Southern city limits	\$650
N	Med	C	Lake Rd Sidewalks	Fill in sidewalk gaps on both sides of street.	Where Else Ln	Hwy 224	\$2,200
Q	Med	C	Logus Rd Sidewalks	Fill in sidewalk gaps on both sides of street.	43 rd Ave	49 th Ave	\$850
T	Med	C	37 th Ave Sidewalks	Fill in sidewalk gaps on both sides of street.	Lake Rd	Harrison St	\$870
AE	Med	C	Brookside Dr Sidewalks	Fill in sidewalk gaps on both sides of street.	Johnson Creek Blvd	Regents Dr	\$20
AT	Med	C	Springwater Trail Completion	Contribute to regional project to complete Springwater Trail ("Sellwood Gap") along Ochoco St.	17 th Ave	19 th Ave	\$90
BA	Med	C	Bicycle and Pedestrian Overpass over Railroad Ave	Establish a dedicated bicycle and pedestrian connection across Railroad Ave and the railroad tracks.	Railroad Ave	International Way	\$2,200
BB	Med	C	Bicycle/Pedestrian Improvements to Main St	Construct multiuse path or other improved bike/ped facilities on Main St to provide safer connection between downtown and Tacoma station. (TSAP)	Hanna Harvester Dr	Tacoma station	\$2,900
BC	Med	C	Bicycle/Pedestrian Connection from Eastern Neighborhoods to Tacoma Station Area	Establish bike/ped connection over existing railroad tracks and light rail to Tacoma station area. (TSAP)	Olsen St & Kelvin St	Mailwell Dr	\$4,000

Map ID ³	Priority	Type	Project Name	Project Description ⁴	From	To	Cost (\$1,000s ⁵)
BD	Med	C	Improved Connection from Springwater Trail to McLoughlin Blvd	Construct stairs or other facility to connect Springwater Trail to west side of McLoughlin Blvd. (TSAP)	Location-specific	Location-specific	\$500
BE	Med	C	Bicycle/Pedestrian Connection over Johnson Creek	Construct bike/ped bridge over Johnson Creek along Clatsop St at 23 rd Ave to connect Tacoma station area with adjacent neighborhood. (TSAP)	Location-specific	Location-specific	\$400
BF	Med	C	Improved Bicycle/Pedestrian Connections on West Side of Tacoma Station Area	Improve bike/ped connections to adjacent neighborhood to west of Tacoma station area at Ochoco St and Milport Rd. (TSAP)	Location-specific	Location-specific	\$500
N/A	Med	C	Downtown Streetscape Improvements	Install sidewalk bulbouts, lighting, and pedestrian amenities.	Downtown	Downtown	\$7,300 ⁶
N/A	Med	O	Pedestrian Walkway Amenities	Install amenities, such as benches, along key walking routes.	Citywide	Citywide	\$60
Low Priority Projects							
G	Low	C	Intersection Improvements at Olsen St and 42 nd Ave	Improve pedestrian crossing.	Location-specific	Location-specific	\$20
H	Low	C	Intersection Improvements at Railroad and 37 th Ave	Improve pedestrian crossing.	Location-specific	Location-specific	\$10
K	Low	C	Intersection Improvements at Stanley Ave and Logus Rd	Improve pedestrian crossing.	Location-specific	Location-specific	\$20
R	Low	C	Olsen St Sidewalks	Fill in sidewalk gaps on north side of street.	32 nd Ave	42 nd Ave	\$470
S	Low	C	Johnson Creek Blvd Sidewalks	Fill in sidewalk gaps on both sides of street.	Harney St	City limits	\$410
W1	Low	C	Linwood Ave Sidewalks (north)	Fill in sidewalk gaps on both sides of street (part of Linwood Ave road-widening project).	Johnson Creek Blvd	King Rd	1,050
X	Low	C	Hwy 224 Sidewalks	Fill in sidewalk gaps on both sides of street.	Oak St	37 th Ave	\$460

⁶ Estimated \$500,000 per block face.

Map ID ³	Priority	Type	Project Name	Project Description ⁴	From	To	Cost (\$1,000s ⁵)
AA	Low	C	Home Ave Sidewalks	Fill in sidewalk gaps on both sides of street.	Railroad Ave	King Rd	\$830
AB	Low	C	Harvey St Sidewalks	Fill in sidewalk gaps on both sides of street.	32 nd Ave	42 nd Ave	\$590
AC	Low	C	Roswell St Sidewalks	Fill in sidewalk gaps on both sides of street.	32 nd Ave	36 th Ave	\$210
AD	Low	C	Mason Lane Sidewalks	Fill in sidewalk gaps on both sides of street.	42 nd Ave	Regents Dr	\$740
AF	Low	C	Regents Dr Sidewalks	Fill in sidewalk gaps on both sides of street.	Brookside Dr	Winsor Dr	\$540
AG	Low	C	Rusk Rd Sidewalks	Fill in sidewalk gaps on both sides of street.	Lake Rd	North Clackamas Park	\$730
AH	Low	C	Pedestrian Connection to North Clackamas Park	Create pedestrian connection between the school and the park.	Rowe Middle School	North Clackamas Park	\$1,400
AI	Low	C	Washington St Sidewalks	Fill in sidewalk gaps on both sides of street.	32 nd Ave	35 th Ave	\$130
AJ	Low	C	22 nd Ave Sidewalks	Fill in sidewalk gaps on both sides of street.	McLoughlin Blvd	Sparrow St	\$360
AK	Low	C	19 th Ave Sidewalks	Fill in sidewalk gaps on both sides of street.	Kellogg Creek Trail	Sparrow St	\$330
AM	Low	C	Oatfield Rd Sidewalks	Fill in sidewalk gaps on both sides of street.	Guilford Ct	City limits	\$150
AN	Low	C	49 th Ave Sidewalks	Fill in sidewalk gaps on both sides of street.	Logus Rd	King Rd	\$270
AO	Low	C	Franklin St Sidewalks	Install sidewalks on both sides of street to connect to Campbell Elementary School.	42 nd Ave	45 th Ave	\$220
AP	Low	C	Ochoco St Sidewalks	Construct sidewalks on Ochoco St to connect bus stops to Goodwill.	19 th Ave	McLoughlin Blvd	\$1,300
AQ	Low	C	Edison St Sidewalks	Fill in sidewalk gaps on both sides of street.	35 th Ave	37 th Ave	\$130
AY	Low	C	Improved Connection from Springwater Trail to Pendleton Site (Tunnel)	Construct tunnel under Springwater Trail to improve connection to Pendleton site at Clatsop St. (TSAP)	Location-specific	Location-specific	\$1,200
BG	Low	C	Intersection Improvement at all Crossings of McLoughlin Blvd	Improve all existing crossings of McLoughlin Blvd (e.g., extended time for crossing, signage). (ODOT to do.)	Location-specific	Location-specific	—
BH	Low	C	Bike/Ped Path on Sparrow St	Establish a dedicated bicycle and pedestrian connection on Sparrow St, connecting River Rd to Trolley Trail	River Rd	Trolley Trail	\$350
BI	Low	C	Bike/Ped Overpass over McLoughlin Blvd at River Rd	Establish a dedicated bicycle and pedestrian connection across McLoughlin Blvd.	Kronberg Park	River Rd	\$2,500

Map ID ³	Priority	Type	Project Name	Project Description ⁴	From	To	Cost (\$1,000s ⁵)
BJ	Low	C	Crossing Improvements for McLoughlin Blvd at Ochoco St and Milport Rd	Construct improvements at Ochoco St and Milport Rd to improve bike/ped crossing of McLoughlin Blvd (per ODOT, this will require full intersection improvements). (TSAP)	Location-specific	Location-specific	\$8,320
BK	Low	C	Bicycle/Pedestrian Connection between McLoughlin Blvd and Stubb St	Establish bike/ped connection to McLoughlin Blvd sidewalk at west end of Stubb St. (TSAP)	Location-specific	Location-specific	\$20
N/A	Low	O	Pedestrian Walkway Signage	Provide maps and wayfinding signage on streets that identify ways to get around the city.	Citywide	Citywide	\$10
Priority to be Determined							
BM	-	C	Harrison/32 nd Ave Intersection	Open the currently closed pedestrian crosswalk on the west leg of the intersection	Location-specific	Location-specific	-
BN	-	C	Oak St/34 th Ave Connection	Provide pedestrian/bicycle connection between Monroe St and 34 th Ave (nearby residential neighborhood)	Location-specific	Location-specific	-
BO	-	C	Campbell St and Railroad Ave upgrades	Provide pedestrian/bicycle treatments on Campbell St and Railroad Ave between Monroe St and Harrison St	Location-specific	Location-specific	-
BP	-	C	Connection through Union Pacific Railroad property	Provide pedestrian/bicycle connection on Union Pacific Railroad land located in the triangle formed by the rail line, Railroad Ave and Monroe St	Location-specific	Location-specific	-

Notes:






C = Capital Project
O = Operational Project
P = Policy Project

High = High priority
Med = Medium priority
Low = Low priority

TSAP = Tacoma Station Area Plan

The Pedestrian Master Plan project list includes several enhanced pedestrian crossing projects. These crossings are located on major roadways with volumes and speeds that would require significant crossing enhancements based on published guidelines in the *Traffic Control Devices Handbook*.⁷ Table 5-2 provides a description of possible crossing enhancements.

Table 5-2 Potential Measures for Enhancing Pedestrian Crossings

Improvement	Description	Illustration	Cost Range
Marked Crosswalk	White thermoplastic markings at street corner. Alternative material could include nonwhite color or textured surfaces.		\$1,000 to \$2,000 per crossing. Textured crossing materials beyond thermoplastic markings could be more expensive depending on materials used.
New Corner Sidewalk Ramp	Construct ADA compliant wheelchair ramps consistent with City standards.		\$3,000 to \$5,000 per corner.
Median Refuge	Construct new raised median refuge area. Minimum width 6 ft, and minimum length of 30 ft. Curb can be mountable to allow emergency vehicles to cross, if required.		\$10,000 to \$20,000, depending on overall length and amenities.
Pedestrian Countdown Timer Signal	Install supplemental pedestrian signal controls to indicate the time remaining before crossing vehicles get 'green' signal indication.		\$2,500 per signal head (\$10,000 per intersection)
Curb Extensions	Construct curb extension on road segments with on-street parking. Reduces pedestrian crossing area, and exposure to vehicle conflicts.		\$20,000 to \$30,000, depending on design amenities and aesthetic treatments.

Source: DKS Associates

⁷ *Traffic Control Devices Handbook*, Institute of Transportation Engineers, 2001; Chapter 13, Table 13-2.

ACTION PLAN

The Pedestrian Action Plan (Table 5-3) identifies the highest priority projects that are reasonably expected to be funded with local funds by 2035, which meets the requirements of the State's Transportation Planning Rule.⁸ The action plan project list is based upon a 2007 citywide project ranking process. In 2007, all of the modal master plan projects were ranked by the TSP Advisory Committee after consideration of the Working Groups' priorities, other public support for the project, and how well each project implements the TSP goals and policies. For the 2013 TSP Update, City staff reassessed the prioritization of all projects, incorporating public comments gathered at and around a public meeting in June 2013. Action plan projects that were completed since 2007 were removed from the action plan and new projects identified as top priorities were added.

Table 5-3 Pedestrian Action Plan

Map ID	Project Name	Project Description	From	To	Project Cost (\$1,000s)	Direct Funding or Grant Match
L	17 th Ave Improvements	Fill in sidewalk gaps on both sides of street; fill in gaps in existing bicycle network with bike lanes; and/or provide multiuse path. Improve intersection safety at Milport Rd, McBrod Ave, Hwy 224, Lava Dr, and Hwy 99E.	Ochoco St	McLoughlin Blvd	\$1,000	Match
BL	Adams St Connector	Construct pedestrian- and bicycle-only facility on Adams St between 21 st Ave and Main St	21 st Ave	Main St	\$450	Match
O	Railroad Ave Capacity Improvements	Pedestrian aspect: Fill in sidewalk gaps on both sides of street or construct multiuse path on one side.	37 th Ave	Harmony Rd	\$1,800	Match
P	Monroe St Neighborhood Greenway	Fill in sidewalk gaps on both sides of street.	42 nd Ave	City limits	\$1,800	Match
AR	Kellogg Creek Dam Removal and Hwy 99E Underpass	Replace Hwy 99E bridge over Kellogg Creek, remove dam, restore habitat. Construct bike/ped undercrossing between downtown Milwaukie and Riverfront Park.	Location-specific	Location-specific	\$9,900	Match
V1	Stanley Ave Neighborhood Greenway (north)	Fill in sidewalk gaps on both sides of street.	Johnson Creek Blvd	King Rd	\$1,900	Match
V2	Stanley Ave Neighborhood Greenway (south)	Fill in sidewalk gaps on both sides of street.	King Rd	Railroad Ave	\$2,800	Match
W2	Linwood Ave Sidewalks (south)	Fill in sidewalk gaps on both sides of street (part of Linwood Ave road-widening project).	King Rd	Railroad Ave	\$2,150	Match
A-E	Intersection Improvements at Hwy 224 Crossings	Improve pedestrian crossings at Freeman Way, 37 th Ave, Oak St, Monroe St, and Harrison St	Location-specific	Location-specific	\$100 (\$20 each)	Match

⁸ OAR Chapter 660, Department of Land Conservation and Development, Division 012, Transportation Planning, adopted on March 15, 2005, effective April 2005.

Map ID	Project Name	Project Description	From	To	Project Cost (\$1,000s)	Direct Funding or Grant Match
AU	Kellogg Creek Bike/Ped Bridge	Construct bike/ped overpass over Kellogg Creek in conjunction with light rail bridge.	Lake Rd	Kronberg Park	\$2,500	Match
AV	Kronberg Park Trail	Construct multiuse path to connect bike/ped bridge to safe crossing of Hwy 99E	Kellogg Creek Bridge	River Rd	\$300	Match
AW	Intersection Improvements at McLoughlin Blvd and 22 nd Ave	Improve safety of Trolley Trail crossing at 22 nd Ave.	Location-specific	Location-specific	\$200	Match
N/A	Study of Pedestrian Crossings on Hwy 224	Examine alternatives for improving pedestrian crossings at five intersections along Hwy 224 (Harrison St, Monroe St, Oak St, 37 th Ave, Freeman Way)	Harrison St	Freeman Way	\$50	Match

REGIONAL TRANSPORTATION PLAN (RTP) COMPLIANCE

The projects identified in the master plan list and further refined in the action plan list are consistent with the Metro 2035 Regional Transportation Plan (RTP). The RTP includes specific goals that can be used to measure the success of regional planning efforts to improve the overall transportation system. Specifically, the master plan and action plan projects identified in this chapter comply with Metro's goals for regional mobility and non-single-occupant-vehicle (non-SOV) modal targets. Chapter 8 includes a discussion of the performance measures and targets that the City has adopted to achieve the relevant RTP goals.

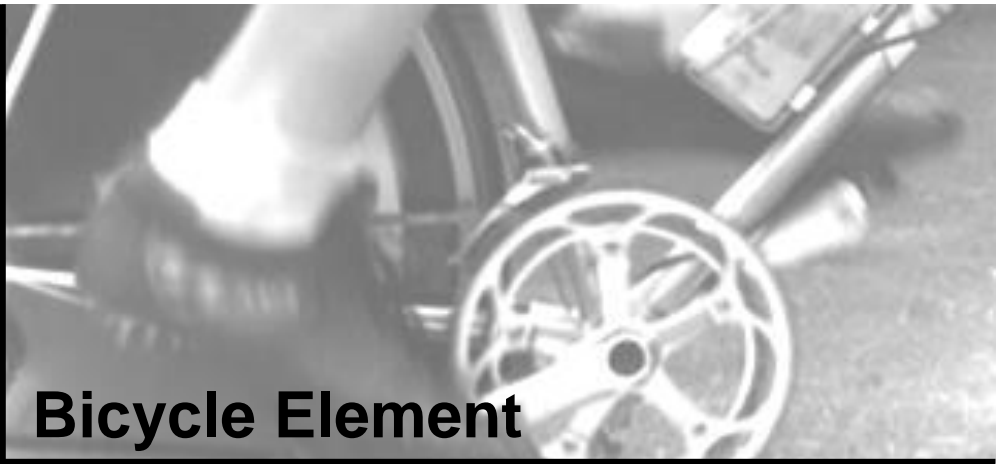
Three of the goals in the 2035 RTP relate to the regional pedestrian system in particular:

- Reduce the number of pedestrian fatalities plus serious injuries by 50% compared to 2005.
- Triple the walking mode share compared to 2005.
- Increase by 50% the number of essential destinations accessible within 30 minutes by trails or within 15 minutes by sidewalks for all residents compared to 2005.

All of the master plan and action plan projects identified in this chapter will contribute significantly toward meeting these regional goals.

6

Bicycle Element



The bicycle is a human-powered vehicle that allows people of all ages to move independently, at relatively low cost and with little impact to the environment. Bicycling promotes the well-being of people who live and work in Milwaukie, with the added benefit of reducing auto traffic on city streets. This chapter outlines bicycle needs in Milwaukie over the next 22 years and recommends policy, operational and facility improvements to the city's bicycle system.

TSP GOAL AND POLICY FRAMEWORK

Milwaukie has developed a set of goals to guide the development of its transportation system (see Chapter 2). Several of these TSP Goals guide the City's policies on bicycle access and connectivity, specifically the following:

- **Goal 1 Livability** calls for convenient bicycling facilities, and removal of barriers that impede capacity.
- **Goal 2 Safety** directs the City to design safe bicycle connections between parks, schools, and other activity centers in Milwaukie.
- **Goal 3 Travel Choices** calls for an integrated citywide network of bikeways.
- **Goal 4 Quality Design** directs the City to integrate bicycle facilities into both public and private street and development projects.
- **Goal 6 Sustainability** calls for the City to increase bicycling as a means of transportation.

NEEDS

Milwaukie needs a safe and interconnected bicycle system that provides options for all types of bicyclists. The deficiencies in Milwaukie's existing bicycle system can be categorized into three areas: Connectivity, Crossings, and Street Designations. Each of these categories is described in this section.

Connectivity

The lack of east/west and north/south on-street bicycle facilities creates significant gaps in the bicycle system for travel both in and around the city. There are two east/west roadways that include bike lanes in the city: King Rd and Lake Rd. However, neither of these facilities reaches the downtown area and/or connects with other facilities that could allow for travel to other

destinations. There are also two north/south roadways that have bike lanes: Linwood Ave and 17th Ave. Similar to the east/west roadways, these corridors are not continuous.

Three off-street facilities serve Milwaukie (the Springwater Corridor, the Trolley Trail, and the Kellogg Creek Trail), but they are not continuous. For example, while the connectivity of the Springwater Corridor was upgraded in 2006 with completion of the "Three Bridges" project (three bridges constructed to cross over the Union Pacific Railroad, McLoughlin Blvd, and Johnson Creek), the trail ends just east of 17th Ave. Additionally, there are a limited number of connections through the city to the Springwater Corridor, especially to the west of 45th Ave. The Trolley Trail, which will be completed in conjunction with the Portland-Milwaukie Light Rail (PMLR) project, ends at Riverfront Park, nearly one mile south of the Springwater Corridor. The Kellogg Creek Trail connects the Milwaukie Riverfront area to the Island Station neighborhood but does not easily connect to points south.

Major facilities, such as McLoughlin Blvd, Hwy 224, and the railroads, create barriers to bicycling through the city, particularly for east-west travel. This lack of connectivity (both on-street and off-street) causes significant problems for bicyclists and limits this mode of travel, especially where they make it more difficult for bicyclists to access major transit stops downtown.

Crossings

Throughout the city, there is a need for convenient and safe crossings at arterials and collectors. There are many locations where bicycle routes cross arterials, highways, or railroad tracks, and few of these crossings were designed to accommodate bicyclists. Typically, such intersections have limited sight-distance, inadequate pavement space for bicycles, no means for tripping a signal, or no direct safe connection. The following locations were identified as specific problem crossings:

- 17th Ave/Hwy 224
- 17th Ave/Harrison St/Hwy 99E
- Railroad crossing of 21st Ave at Adams
- Johnson Creek Blvd/Springwater Corridor
- King Rd/Stanley Ave
- Linwood Ave/Springwater Corridor
- King Rd/Linwood Ave
- Monroe St/Linwood Ave
- Linwood Ave/Harmony Rd

Street Designations

The designation of certain roadways for bicycle travel does not serve all of the needs for bicycle travel in and around the city. Many trips that connect to parks, schools, retail activity centers, etc., occur off of arterial and collector streets. These trips should generally be accommodated on lower volume streets, preferably on designated routes. Such facilities could be considered "shared" facilities or could have a specific designation such as a "bike boulevard" or "neighborhood greenway," where actual treatments to the roadway are made that enhance the bicycle environment and make additional connections to bicycle destinations.

BICYCLE FACILITY IMPROVEMENT TOOLBOX

Types of Bicyclists

Bicyclists are a varied group of people with different skill levels, abilities, bicycling experience, and trip types. For example, there are everyday commuters, avid recreational riders, children going to school, and families riding around in their neighborhoods. Their needs and comfort level with the bicycle infrastructure in Milwaukie will vary as a result of these differences. The City needs to accommodate these different types of bicyclists by providing adequate facilities for all different types of riders.

Bicycle trips are typically longer than walking trips and shorter than motor vehicle trips, and are attractive at distances up to three miles. Bicycle facilities can generally be categorized as multiuse paths, cycle tracks, bike lanes, shared roadways, and neighborhood greenways. Each of these facilities serves a particular purpose for bicycle travel. Bike lanes, cycle tracks, and multiuse paths can all accommodate trips of up to three miles. However, if the trip is shorter, or if the destination or origin of the trip is not next to a roadway with a bike lane, many bicycle trips can also be made on local streets. Table 6-1 summarizes each of these facilities with a general description of the elements inherent to each facility.

Table 6-1 Bikeway Types

Bikeway	Description
Multiuse path	Off-street route, typically recreational-focused, which can be used by several transportation modes, including bicycles, pedestrians, and other nonmotorized modes (i.e., skateboards, roller blades, etc.).
Cycle track	Exclusive bike facility within the roadway, with elements of both a separated path and a bike lane. Separated from motor vehicle traffic by parked cars, bollards, landscaping, or other barriers.
Bike lane	Area within street right-of-way specifically designated for bicycle use.
Shared roadway	Roadways where bicyclists and autos share the same travel lane. May include a wider outside lane and/or bike boulevard treatment (priority given to through bikes on local streets).
Neighborhood greenway	Lower-order, lower-volume streets with various treatments to promote safe and convenient bicycle travel and enhance pedestrian travel as well. Usually accommodate bicyclists and motorists in the same travel lanes, often with no specific vehicle or bicycle lane delineation. Assign higher priority to through bicyclists, with secondary priority assigned to motorists. Also include treatments to slow vehicle traffic to enhance the bicycling environment.

Bicycle Facility Design Considerations

Multiuse Paths

As their name implies, multiuse paths are designed to accommodate many types of users, and are typically constructed along an independent path such as a stream or greenway. Paths can also be built parallel to a roadway, but are most effective when built independent of a road, separating bicyclists from auto traffic. The American Association of State Highway Transportation Officials (AASHTO)¹ and the Oregon Department of Transportation (ODOT)² state that mixed-use paths can be designed along roadways, provided several design considerations are met:

- A minimum 5-foot buffer should be provided between the path and roadway to protect path users from conflicts with motorists.
- Relatively few vehicle/path user conflict points (e.g., cross-streets or driveways).
- The path can be terminated at each end onto streets with good bicycle/pedestrian facilities or onto another safe, well-designed path.
- The path should not take the place of bicycle/pedestrian facilities (e.g., sidewalks and bicycle lanes) on the parallel street.

Figure 6-1 Multiuse Path



Photo credit: Vince Schreck, www.pdxfamilyadventures.com

Cycle Tracks

Cycle tracks can take a number of forms, depending on the nature of the existing street infrastructure. They combine some elements of a fully separated path with those of a bike lane in the roadway. The key element of a cycle track is that it uses parked cars, bollards, landscaping, curbing, or other barriers to provide some separation from motor vehicle traffic. Cycle tracks may be one-way or two-way, and they may be located at road level, sidewalk level, or an intermediate level. They are distinct from the sidewalk and are designed exclusively as bike facilities. A recommended minimum width is 7 feet, with an additional 2-ft "door zone" buffer (where adjacent to parked cars). Pavement markings on the cycle track provide guidance for bicyclists, as well as for motorists and pedestrians that may cross the cycle track at driveways or intersections.

Figure 6-2 Cycle Track



Photo credit: Michael O'Hare, www.citiesforpeople.net

There are currently no cycle tracks in Milwaukie, and no potential cycle track routes have been identified to date. However, this type of facility represents an option for future bike improvements that might be most appropriate in certain settings to provide safer bike routes in high-traffic corridors.

¹ *A Guide for the Development of Bicycle Facilities*, American Association of State Highway and Transportation Officials, 1999.

² *Oregon Bicycle and Pedestrian Plan, An Element of the Oregon Transportation Plan*, Oregon Department of Transportation, Adopted June 14, 1995.

Bike Lanes

When possible, bike lanes should be directly adjacent to the curb, rather than adjacent to parked cars or combined with sidewalks. The recommended width of six feet provides sufficient travel space and additional room for bicyclists to steer clear of the curb or parked cars while maintaining a comfortable distance from adjacent moving traffic. Wide bike lanes also enable bicyclists to maneuver around drainage grates, manhole covers, glass and debris. Provision of bike lanes also benefits motor vehicles, which gain greater shy distance/emergency shoulder area, and pedestrians, who gain a buffer between walking areas and moving vehicles. Where right-of-way is limited, the bike lane can be reduced to 5 feet. Alternatively, widening the curb travel lane (for example, from 12 feet to 14 or 15 feet) can provide better bicycle accommodations and a greater measure of safety as well. However, with higher-volume roadways (e.g., streets with more than 3,000 Average Daily Trips), dedicated bike lanes are much more desirable than wide outside lanes.

The signing and marking of bike lanes should follow the *Manual on Uniform Traffic Control Devices* (MUTCD). Design features in the roadway can improve bicycle safety as well. For example, using curb storm drain inlets rather than catch basins significantly improves bicycle facilities.

Figure 6-3 Bike Lane



Photo credit: LA-32 Neighborhood Council,
<http://la32nc.org/category/transportation/>

Shared Roadways

Shared roadways can be designed to safely accommodate both bicycle and auto traffic. Figure 6-5 illustrates an example of an appropriate warning sign with a supplemental "Share the Road" plaque that may be used to draw more attention to the fact that slow-moving forms of transportation may be using the roadway. When used, the supplemental plaque must be installed below the warning sign on the same signpost. Directional pavement markings may also be considered on shared roadways to supplement the bicycle warning signs when desired. The pavement markings illustrated in Figure 6-5 below are typically called "Sharrows" or "Shared Lane Markings" and are utilized on bicycle travel routes that have on-street parking but no designated bike lanes. Sharrows are commonly used on streets where dedicated bike lanes are desirable but are not possible for any number of reasons. The marking helps to align bicyclists, to shift their travel pattern out of the direction of a parked car door opening into their travel path.

Figure 6-4 Shared Roadway



Photo credit: Portland Bureau of Transportation,
www.portlandoregon.gov/transportation/

Figure 6-5 Bicycle Signs and Markings



It should be noted, however, that while posting "Bike Route" signage for bicyclists is an acceptable way for the City to demarcate bike routes, such signs should be coupled with pavement markings and/or way finding signage for bicyclists to get the most value out of the City's investment. Although this is an adopted MUTCD sign, it does not provide much information. Adding wayfinding information such as distances to various destinations, directional arrows, and estimated travel times makes the sign much more useful. These signs are most effective when placed in useful locations, such as where a bike route makes a turn that is not intuitive to riders.

Neighborhood Greenways

The term "neighborhood greenway" has recently evolved from the "bike boulevard" concept of treatments, which improve the network of safe bicycle routes by generally utilizing streets with lower traffic volumes and vehicle speeds, such as minor collectors or local streets that pass through residential neighborhoods. The neighborhood greenway treatments also make these routes safer for pedestrians and motorists (for example, through inclusion of traffic-calming devices), while at the same time incorporating low-impact stormwater treatment measures such as bioswales and raingardens. The general traffic calming provided by neighborhood greenway improvements adds to neighborhood livability.

Figure 6-6 Neighborhood Greenway



Image credit: Bicycle Transportation Alliance/Owen Walz, owenwalzdesign.com

Traffic controls along a neighborhood greenway assign priority to bicyclists while encouraging through-vehicle traffic to use alternate parallel routes. Traffic calming and other treatments along the corridor reduce motor vehicle speeds so that motorists and bicyclists generally travel at the same speed, creating a safer and more comfortable environment for all users. Neighborhood greenways also incorporate treatments to facilitate safe and convenient crossings of major streets. Neighborhood greenways work best in well-connected street grids, where riders can follow reasonably direct and logical routes and where higher-order, parallel streets exist to serve through-vehicle traffic.

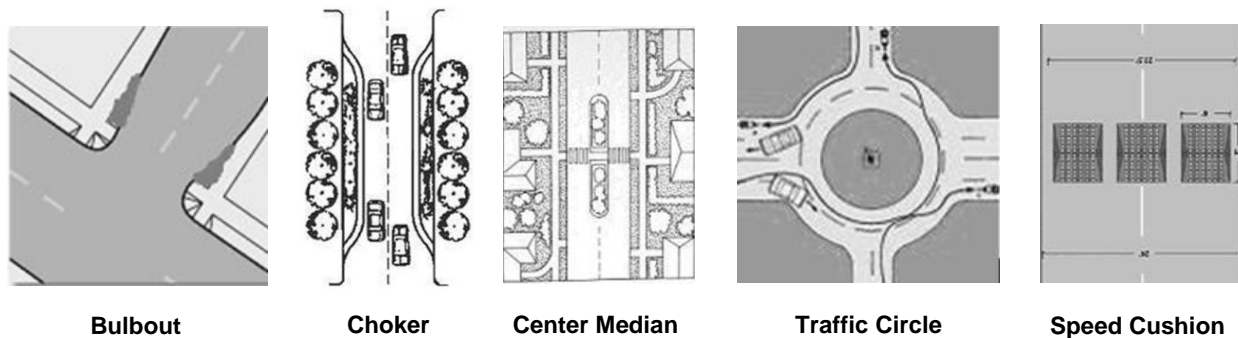
Milwaukie's neighborhood greenway network could be developed through a variety of improvements ranging from minor street enhancements (e.g., directional pavement markings) to larger-scale projects (e.g., intersection signalization). The various treatments fall into five major application levels based on their degree of physical intensity, with Level 1 representing the least physically intensive treatments that can be implemented at relatively low cost:

- **Level 1: Signage** (e.g., wayfinding and warning signs along and approaching the neighborhood greenway).
- **Level 2: Pavement markings** (e.g., directional pavement markings, shared lane markings).
- **Level 3: Intersection treatments** (e.g., signalization, curb extensions, refuge islands).
- **Level 4: Traffic calming** (e.g., speed humps, mini traffic circles).
- **Level 5: Traffic diversion** (e.g., choker entrances, traffic diverters).

Corridors targeted for higher-level applications would also receive relevant lower-level treatments. For instance, a street targeted for Level 3 applications should also include Level 1 and 2 applications as necessary. It should be noted that some applications might not be appropriate on all streets. In other words, it may not be necessary to implement all Level 2 applications on a particular street designated for Level 2 treatment in order to create a functional neighborhood greenway.

Figure 6-7 shows examples of some of the types of intersection treatments and traffic-calming measures that could be appropriate for application on neighborhood greenway routes. Some study and analysis is necessary to determine which measures would be most effective in specific locations. Within Chapter 11 Neighborhood Traffic Management, Table 11-1 provides more examples of traffic-calming measures.

Figure 6-7 Sample Traffic-Calming Measures



Experience from other cities that have implemented neighborhood greenways shows that on-street vehicle parking can function as a traffic-calming measure. Drivers generally seem to slow down in response to the physical narrowing of the travel lane and the higher perceived risk of collision. In addition, parked cars create a barrier between moving cars on the street and pedestrians on the sidewalk. This barrier enhances both actual and perceived safety for pedestrians. Allowing or encouraging on-street vehicle parking can be one tool employed to make neighborhood greenways safe and pleasant for nonmotorized travel.

Bicycle Parking

Bicycle parking and storage facilities are an important component of an effective bicycle system. Lack of proper storage facilities discourages potential riders from traveling by bicycle. Bike racks should be located at significant activity generators including schools, parks, and commercial areas, as well as at major transit stops. Racks should be placed in highly visible locations and within convenient proximity to main building entrances. Bike racks should be designed to

provide two points of contact to the bicycle so the user can lock both the wheel and the frame to the rack. Bike lockers, showers, and caches of repair equipment (patch kits, tire tubes, etc.) would be helpful at locations where long-term parking is expected, such as the future light rail (MAX) stations (downtown, on Park Ave, and at Tacoma St), downtown bus stops, and major employment centers. The attractiveness of bicycle parking is also improved by providing covered parking and/or secured facilities where bicycles may be locked away.

RECOMMENDATIONS

Strategies

Bikeway improvements are aimed at closing the gaps in the bicycle network along arterial and collector roadways, establishing low-traffic routes that parallel arterials and collectors, and providing multimodal links to improve livability. To meet the TSP goals and policies outlined in Chapter 2, and address the needs outlined in this chapter, the City should take the following steps for improving the bicycle system:

- Fill in gaps in the existing bike corridor network (on arterials and collectors).
- Construct new bike lanes on strategic arterials and collectors.
- Connect key bicycle corridors to schools, parks, activity centers, and major transit stops.
- Improve crossing safety and connectivity.
- Designate neighborhood greenways on lower-volume streets that connect major bicycle facilities and/or bicycle destinations.
- Maintain bike lanes, off-street paths, signage, and other facility improvements.
- Construct and improve multiuse paths for recreational and commuter use.
- Involve bicyclists in the design and planning of bicycle and road facilities.
- Educate bicyclists and motorists about bicycle routes, laws, and opportunities.
- Directly implement or encourage the establishment of a bike-share program. This strategy could range from City ownership and administration of a bike-share system to revisions to the Municipal Code to allow for bike-share facilities owned by other private or public entities.

These strategies will be used to guide and develop projects that address the needs of the bicycling community in Milwaukie as well as those of bicyclists throughout the region. The projects resulting from these strategies fall into three categories: capital, operational and maintenance, and policy. Capital strategies involve building physical infrastructure. Operational and maintenance strategies aim to make existing infrastructure more usable. Policy-oriented strategies seek to modify public processes in order to more effectively support bicycling as a viable transportation mode. Key projects in each of these categories are described below.

Capital

These projects are typically large-scale infrastructure projects or projects that require some sort of physical infrastructure to be built. Capital projects also typically require ongoing maintenance that must be programmed into the existing maintenance schedule.

Key projects

17th Ave between Waverly Dr and Harrison St is a key bicycle connection between downtown Milwaukie and the Sellwood neighborhood in Portland. This connection will be improved by constructing bike lanes and/or a multiuse path. In addition, several potential neighborhood greenway corridors have been identified to enhance Milwaukie's bicycle network. The corridors

were identified with respect to major bicycling destinations as well as their proximity to desired bicycle travel routes. The recommended corridors are shown in Figure 6-8a and described below:

- Monroe St between downtown Milwaukie and Linwood Ave.
- Stanley Ave between Railroad Ave and Johnson Creek Blvd.
- A corridor roughly following 40th Ave north from Monroe St and then splitting into two separate corridors at Harvey St. One neighborhood greenway would continue north on 40th Ave and follow Olsen St and 42nd Ave to connect with Johnson Creek Blvd. The second neighborhood greenway would follow Harvey St west from 40th Ave and follow Balfour St, 29th Ave, and Van Water St to connect with the Springwater Corridor. If 29th Ave is extended to the south, the neighborhood greenway should connect to the south as well (see Figure 8-4, which shows the future extension of 29th Ave).
- A corridor following 19th Ave south from Eagle St to Sparrow St, then east on Sparrow St to River Rd. This corridor could be extended east on Sparrow St with construction of a multiuse path connecting to the Trolley Trail.

These neighborhood greenways should be targeted for Level 4 applications, including signage, pavement markings, intersection treatments, and traffic calming. Each corridor currently includes some boulevard components (e.g., speed humps). Due to limited street connectivity, Level 5 bike boulevard applications (traffic diversion) are not recommended for these corridors. To identify and develop additional site-specific treatments, the City should involve the bicycling community, neighborhood groups, and the Public Works Department. Further analysis and engineering work may also be necessary to determine the feasibility of some applications.

Operational and Maintenance

These projects involve actions that make existing infrastructure more useable. They include upkeep of existing facilities, educational campaigns, or distributing information about the use of the transportation network. They are typically smaller in scale and dollars than capital projects and are implemented more broadly than in one specific location.

Key projects

- Driver and bicyclist education, including driver and biker awareness classes, "Share the Road" safety class, bike safety education for kids and adults.
- Encouraging bicycling through community events to get new bicyclists involved and interested in how to commute by bike.
- Consider applying rumble strips or other treatments to safely define bike lanes in places, such as Johnson Creek Blvd, where vehicles commonly cross into the bike lane.

Policy

These projects do not typically improve the bicycle environment in a physical manner, but rather result in a fundamental change to the way bicycle travel is thought of and treated within the city of Milwaukie.

Key projects

- Enforce traffic laws that protect bicyclists.
- Collect and maintain bicycling traffic counts to measure the effect of improvements.

- Work with the City of Portland and Clackamas County when implementing bike boulevards, bike lanes, and multiuse paths to ensure good connectivity beyond Milwaukie.
- Consider establishing a committee to advise and advocate for implementation of the projects in this plan.

Master Plan

The Bicycle Master Plan is composed of a list of projects that address the identified needs (see Figure 6-8a). An inset map showing more detail in the downtown area is provided in Figure 6-8b. Summarized in Table 6-2, the master plan represents the "wish list" of bicycle-related projects in Milwaukie. The planning-level cost estimates provided in Table 6-2 are based on general unit costs for transportation improvements but do not reflect the unique elements that can significantly add to project costs. As projects are pursued, each of these project costs will need further refinement in order to detail right-of-way requirements and costs associated with special design details.



Transportation System Plan

FIGURE 6-8a

BICYCLE MASTER PLAN

April 2015

LEGEND

Existing Bicycle Facilities		Proposed Improvements	
	Shared Lane		Bicycle Intersection Safety Improvement
	Bicycle Lane		Bicycle Lanes
	Kellogg Creek Trail		Neighborhood Greenway
	Springwater Trail		Central Milwaukee 2015 TSP Amendments
	Trolley Trail		

	Schools		Railroad		City Limits
	Major Roads		County Line		Light Rail Station
	Streets		Water		Light Rail Transit
			Parks		

PROPOSED PROJECTS

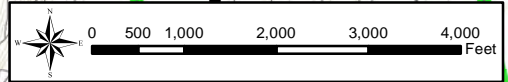
- Improve Intersection to Increase Bicycle Safety**
- A Adams St/21st Ave/Railroad Crossing
 - B Johnson Creek Blvd/Springwater Trail
 - C Johnson Creek Blvd/Linwood Ave
 - D Linwood Ave/King Rd
 - E Linwood Ave/Monroe St
 - F Linwood Ave/Harmony Rd
 - G Washington St/Oak St/Hwy 224
 - H International Way/Lake Rd
 - I McLaughlin and 22nd
 - J McLaughlin/Ochoco/Milport

Provide Bicycle Lanes Where not Currently Present
See Table 6-2 for project descriptions B-R, AI, and AJ

- Enhance Existing Bicycle Connection**
- U1 Install Neighborhood Greenway treatments at various locations
 - V Construct bicycle overpass from Railroad Ave to International Way
 - W Improve Springwater Trail paving
 - X Improve Kellogg Creek Trail
 - Y Install Trolley Trail signage
 - Z Fill in gaps in existing bike network with bike lanes or multiuse path.

- Improve Intersection Safety**
- AB Complete Springwater Trail along Ochoco St
 - AC Construct Kronberg Park Trail
 - AD Construct bike-ped overpass over Kellogg Creek
 - AE Construct pedestrian underpass under HWY 99E at Kellogg Creek
 - AG Pave connection to Springwater Trail at 29th Ave and Sherrett
 - AH Improve connection from Springwater Corridor to Pendleton Site
 - AK Establish bike-ped connection over railroad tracks and LRT
 - AL Construct stairs to connect Springwater Corridor to McLaughlin Blvd
 - AM Construct bike-ped bridge over Johnson Creek along Clatsop St at 23rd Ave to connect to LRT station
 - AN Improve bike-ped connection to neighborhoods west of station
 - AO Establish bike-ped path on Sparrow to connect River Rd to Trolley Trail
 - AP Establish bike-ped connection over McLaughlin at River Rd
 - AR Establish bike-ped connection to McLaughlin at Stubb St

- Provide Improved Bicycle Facilities in Central Milwaukee**
See Table 6-2 for project descriptions AS, AT, AU, AV, and AW





Transportation System Plan

FIGURE 6-8b

BICYCLE MASTER PLAN DOWNTOWN INSET

November 2013

LEGEND

Existing Bicycle Facilities

- Shared Facility
- Bicycle Lane
- Kellogg Creek Trail
- Trolley Trail

Proposed Improvement

- Intersection Improvements
- Bike Lanes
- Neighborhood Greenway

PROPOSED PROJECTS

Improve Intersection to Increase Safety

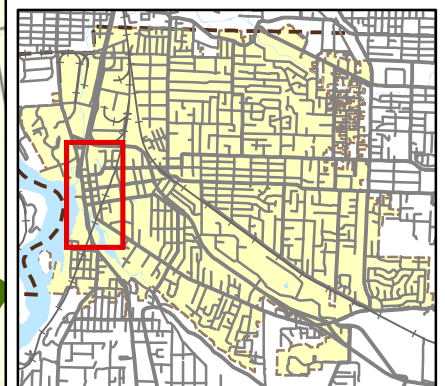
- McLoughlin and 22nd*

Provide Bicycle Lanes Where not Currently Present

- Fill in gaps in bike lanes on Harrison St*

Enhance Existing Bicycle Connection

- Improve Kellogg Creek Trail*
- Fill in gaps in existing bike network and improve intersection safety on 17th Ave and HWY 224/99E*
- Construct Kronberg Park Trail*
- Construct bike-ped overpass over Kellogg Creek*
- Construct pedestrian underpass under HWY 99E at Kellogg Creek*



DKS Associates
TRANSPORTATION SOLUTIONS

0 75 150 300 450 600 Feet

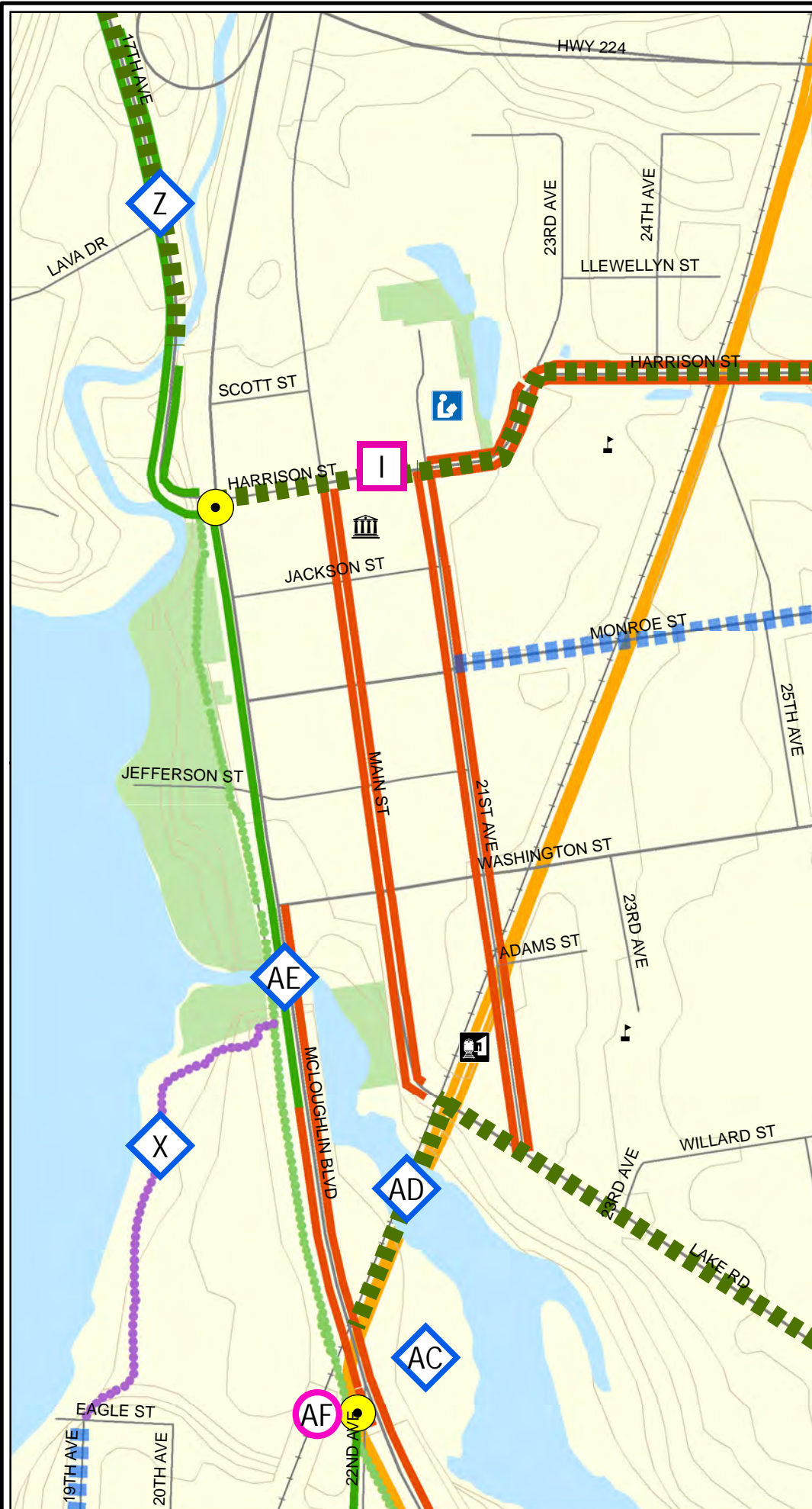


Table 6-2 Bicycle Master Plan Projects

Map ID ³	Priority	Type	Project Name	Project Description	From	To	Cost (\$1,000s ⁴)
High Priority Projects							
E	High	C	Intersection Improvements at Linwood Ave and Monroe St	Improve safety of crossing at intersection.	Location-specific	Location-specific	\$10
G	High	C	Hwy 224 Crossing Improvements at Oak and Washington St	Improve intersection crossing safety for bicyclists at Washington St and Oak St.	Location-specific	Location-specific	\$10
J	High	C	Lake Rd Bike Lanes	Fill in gaps in existing bicycle network with bike lanes.	Main St	Guilford Dr	\$3,400
N	High	C	Railroad Ave Capacity Improvements	Bicycle aspect: Fill in gaps in existing bicycle network with bike lanes, cycle track, multiuse path, or other facilities.	37 th Ave	Linwood Ave	\$4,800
U1	High	C	Monroe St Neighborhood Greenway (downtown)	Designate as a "neighborhood greenway" and install traffic-calming improvements.	21 st Ave	Hwy 224	\$85
U2	High	C	Monroe St Neighborhood Greenway (central)	Designate as a "neighborhood greenway" and install traffic-calming improvements.	Hwy 224	42 nd Ave	\$80
U3	High	C	Monroe St Neighborhood Greenway (east)	Designate as a "neighborhood greenway" and install traffic-calming improvements.	42 nd Ave	Linwood Ave	\$165
U4	High	C	29 th /Harvey/40 th Neighborhood Greenway	Designate as a "neighborhood greenway" and install traffic-calming improvements.	Springwater Trail	Monroe St	\$220
U5	High	C	Stanley Ave Neighborhood Greenway (north)	Designate as a "neighborhood greenway" and install traffic-calming improvements.	Springwater Trail	King Rd	\$135
U6	High	C	Stanley Ave Neighborhood Greenway (south)	Designate as a "neighborhood greenway" and install traffic-calming improvements.	King Rd	Railroad Ave	195

³ See Figure 6-3a.

⁴ Project costs are order-of-magnitude estimates and are in 2012 dollars. Future costs may be more due to inflation. In the case of operational projects, estimated costs are for the entire 22-year planning period.

Map ID ³	Priority	Type	Project Name	Project Description	From	To	Cost (\$1,000s ⁴)
Z	High	C	17 th Ave Improvements	Fill in sidewalk gaps on both sides of street, fill in gaps in existing bicycle network with bike lanes, and/or provide multiuse path. Improve intersection safety at Milport Rd, McBrod Ave, Hwy 224, Lava Dr, and Hwy 99E.	Ochoco St	McLoughlin Blvd	\$1,000
AC	High	C	Kronberg Park Trail	Construct multiuse path to connect bike/ped bridge to safe crossing of Hwy 99E.	Kellogg Creek Bridge	River Rd	\$300
AD	High	C	Kellogg Creek Bike/Ped Bridge	Construct bike/ped overpass over Kellogg Creek in conjunction with light rail bridge.	Lake Rd	Kronberg Park	\$2,500
AE	High	C	Kellogg Creek Dam Removal and Hwy 99E Underpass	Replace Hwy 99E bridge over Kellogg Creek, remove dam, restore habitat. Construct bike/ped undercrossing between downtown Milwaukie and Riverfront Park.	Location-specific	Location-specific	\$9,900
AF	High	C	Intersection Improvements at McLoughlin Blvd and 22 nd Ave	Improve safety of Trolley Trail crossing at 22 nd Ave.	Location-specific	Location-specific	\$200
AG	High	C	Improved Connection to Springwater Trail at 29 th Ave and Sherrett St	Pave the connection to Springwater Trail at 29 th Ave and Sherrett St. (TSAP)	Location-specific	Location-specific	\$20
AH	High	C	Improved Connection from Springwater Trail to Pendleton Site (Ramps)	Construct ramps to improve existing connection of Springwater Trail to Pendleton site at Clatsop St. (TSAP)	Location-specific	Location-specific	\$630
AH	High	C	Improved Connection from Springwater Trail to Pendleton Site (Widened Undercrossing)	Widen existing undercrossing to improve connection of Springwater Trail to Pendleton site at Clatsop St. (TSAP)	Location-specific	Location-specific	\$100
N/A	High	O	Bike Lane Maintenance	Sweep bike lanes to remove debris.	Citywide	Citywide	\$1,200
N/A	High	O	Bicycle-friendly Street Grates	Install bicycle-friendly street grates.	Citywide	Citywide	\$60

Map ID ³	Priority	Type	Project Name	Project Description	From	To	Cost (\$1,000s ⁴)
Medium Priority Projects							
I	Med	C	Harrison St Bike Lanes	Fill in gaps in existing bicycle network with bike lanes (cost included with Harrison St road widening project).	Hwy 99E	21 st Ave	\$300
K	Med	C	Oatfield Rd Bike Lanes	Fill in gaps in existing bicycle network with bike lanes.	Guilford Ct	Lake Rd	\$380
U7	Med	C	19 th and Sparrow Neighborhood Greenway	Designate as a "neighborhood greenway" and install traffic-calming improvements. This would connect the south end of Kellogg Creek Trail to River Rd.	Eagle St	River Rd	\$800
V	Med	C	Bicycle and Pedestrian Overpass over Railroad Ave	Establish a dedicated bicycle and pedestrian connection across Railroad Ave and the railroad tracks.	Railroad Ave	International Way	\$2,200
AB	Med	C	Springwater Trail Completion	Contribute to regional project to complete Springwater Trail ("Sellwood Gap") along Ochoco St.	17 th Ave	19 th Ave	\$90
AI	Med	C	International Way Bicycle Facilities	Construct bike lanes or other bike facilities.	37 th Ave	Lake Rd	\$400
AJ	Med	C	Bicycle/Pedestrian Improvements to Main St	Construct multiuse path or other improved bike/ped facilities on Main St to provide safer connection between downtown and Tacoma station. (TSAP)	Hanna Harvester Dr	Tacoma station	\$2,900
AK	Med	C	Bicycle/Pedestrian Connection from Eastern Neighborhoods to Tacoma Station Area	Establish bike/ped connection over existing railroad tracks and light rail to Tacoma station area. (TSAP)	Olsen St & Kelvin St	Mailwell Dr	\$4,000
AL	Med	C	Improved Connection from Springwater Trail to McLoughlin Blvd	Construct stairs or other facility to connect Springwater Trail to west side of McLoughlin Blvd. (TSAP)	Location-specific	Location-specific	\$500
AM	Med	C	Bicycle/Pedestrian Connection over Johnson Creek	Construct bike/ped bridge over Johnson Creek along Clatsop St at 23 rd Ave to connect Tacoma station area with adjacent neighborhood. (TSAP)	Location-specific	Location-specific	\$400
AN	Med	C	Improved Bicycle/Pedestrian Connections on West Side of Tacoma Station Area	Improve bike/ped connections to adjacent neighborhood to west of Tacoma station area at Ochoco St and Milport Rd. (TSAP)	Location-specific	Location-specific	\$500

Map ID ³	Priority	Type	Project Name	Project Description	From	To	Cost (\$1,000s ⁴)
N/A	Med	O	Bicyclist Education	Promote bicycling through bike use and route selection education.	Citywide	Citywide	\$10
N/A	Med	O	Community Bicycle Rides	Support community bike rides to encourage bike use.	Citywide	Citywide	\$5
Low Priority Projects							
B	Low	C	Springwater Trail Intersection Improvements at 45 th Ave	Improve safety of crossing at intersection.	Location-specific	Location-specific	\$10
C	Low	C	Intersection Improvements at Johnson Creek Blvd and Linwood Ave	Improve safety of crossing at intersection.	Location-specific	Location-specific	\$10
D	Low	C	Intersection Improvements at Linwood Ave and King Rd	Improve safety of crossing at intersection.	Location-specific	Location-specific	\$10
H	Low	C	Intersection Improvements at International Way and Lake Rd	Improve safety of crossing at intersection.	Location-specific	Location-specific	\$10
L	Low	C	Harrison St Bike Lanes	Fill in gaps in existing bicycle network with bike lanes.	Hwy 224	42 nd Ave	\$10
M	Low	C	37 th Ave Bike Lanes	Fill in gaps in existing bicycle network with bike lanes.	Harrison St	Hwy 224	\$3,200
O	Low	C	43 rd Ave Bike Lanes	Fill in gaps in existing bicycle network with bike lanes.	King Rd	Filbert St	\$1,100
P	Low	C	Linwood Ave Bike Lanes (north)	Fill in gaps in existing bicycle network with bike lanes.	Queen Rd	Johnson Creek Blvd	\$1,900
Q	Low	C	Linwood Ave Bike Lanes (south)	Fill in gaps in existing bicycle network with bike lanes.	Juniper St	Harmony Rd	\$320
R	Low	C	Rusk Rd Bike Lanes	Fill in gaps in existing bicycle network with bike lanes.	Lake Rd	North Clackamas Park	\$1,000
X	Low	C	Kellogg Creek Trail Improvements	Resurface trail and provide wayfinding signage to/from trail.	Milwaukie Riverfront	Treatment Plant	\$680
AH	Low	C	Improved Connection from Springwater Trail to Pendleton Site (Tunnel)	Construct tunnel under Springwater Trail to improve connection to Pendleton site at Clatsop St. (TSAP)	Location-specific	Location-specific	\$1,200
AO	Low	C	Bike/Ped Path on Sparrow St	Establish a dedicated bicycle and pedestrian connection on Sparrow St, connecting River Rd to Trolley Trail	River Rd	Trolley Trail	\$350

Map ID ³	Priority	Type	Project Name	Project Description	From	To	Cost (\$1,000s ⁴)
AP	Low	C	Bike/Ped Overpass over McLoughlin Blvd at River Rd	Establish a dedicated bicycle and pedestrian connection across McLoughlin Blvd.	Kronberg Park	River Rd	\$2,500
AQ	Low	C	Crossing Improvements for McLoughlin Blvd at Ochoco St and Milport Rd	Construct improvements at Ochoco St and Milport Rd to improve bike/ped crossing of McLoughlin Blvd (per ODOT, this will require full intersection improvements). (TSAP)	Location-specific	Location-specific	\$8,320
AR	Low	C	Bicycle/Pedestrian Connection between McLoughlin Blvd and Stubb St	Establish bike/ped connection to McLoughlin Blvd sidewalk at west end of Stubb St. (TSAP)	Location-specific	Location-specific	\$20
N/A	Low	O	Milwaukie Bike Map	Produce a Milwaukie Bike Map.	Citywide	Citywide	\$60
N/A	Low	O	Police Enforcement on Drivers	Enforce laws related to bike lanes and bicycle safety.	Citywide	Citywide	\$10
N/A	Low	O	Bike Lane Striping	Restripe existing bike lanes and stripe bike lanes on streets where buses and bicyclists share the road.	Citywide	Citywide	\$20
N/A	Low	C	Springwater Trail Signage	Install wayfinding signage for Springwater Trail.	Citywide	Citywide	\$20
N/A	Low	O	North Clackamas Greenway Corridor Study	Study feasibility of corridor for multiuse path construction (possibly along Kellogg Creek).	Downtown	Clackamas Regional Center	\$50
Priority to be Determined							
AS	-	C	Oak St/34 th Ave Connection	Provide pedestrian/bicycle connection between Monroe St and 34 th Ave (nearby residential neighborhood)	Location-specific	Location-specific	-
AT	-	C	Northern Bike Connection	Provide a bicycle connection through the Murphy site north to 29 th Ave	Location-specific	Location-specific	-
AU	-	C	Crossing at Harrison St/31 st Ave	Provide bicycle crossing across Harrison St between Campbell St and 31 st Ave	Location-specific	Location-specific	-
AV	-	C	Campbell St and Railroad Ave upgrades	Provide pedestrian/bicycle treatments on Campbell St and Railroad Ave between Monroe St and Harrison St	Location-specific	Location-specific	-
AW	-	C	Connection through Union Pacific Railroad property and McFarland site	Provide pedestrian/bicycle connection on Union Pacific Railroad land located in the triangle formed by the rail line, Railroad Ave and Monroe St; continues through McFarland site	Location-specific	Location-specific	-

Map ID ³	Priority	Type	Project Name	Project Description	From	To	Cost (\$1,000s ⁴)
AS	-	C	Oak St/34 th Ave Connection	Provide pedestrian/bicycle connection between Monroe St and 34 th Ave (nearby residential neighborhood)	Location-specific	Location-specific	-
AT	-	C	Northern Bike Connection	Provide a bicycle connection through the Murphy site north to 29 th Ave	Location-specific	Location-specific	-

Notes:

C = Capital Project High = High priority TSAP = Tacoma Station Area Plan
O = Operational Project Med = Medium priority
P = Policy Project Low = Low priority

Action Plan

The Bicycle Action Plan (Table 6-3) identifies the highest priority projects that are reasonably expected to be funded with local funds by 2035, which meets the requirements of the State's Transportation Planning Rule.⁵ The action plan project list is based upon a 2007 citywide project ranking process. In 2007, all of the modal master plan projects were ranked by the TSP Advisory Committee after consideration of the Working Groups' priorities, other public support for the project, and how well each project implements the TSP goals and policies. For the 2013 TSP Update, City staff reassessed the prioritization of all projects, incorporating public comments gathered at and around a public meeting in June 2013. Action plan projects that were completed since 2007 were removed from the action plan and new projects identified as top priorities were added.

Table 6-3 Bicycle Action Plan

Map ID	Project Name	Project Description	From	To	Project Cost (\$1,000s)	Direct Funding or Grant Match
Z	17 th Ave Improvements	Fill in sidewalk gaps on both sides of street, fill in gaps in existing bicycle network with bike lanes, and/or provide multiuse path. Improve intersection safety at Milport Rd, McBrod Ave, Hwy 224, Lava Dr, and Hwy 99E.	Ochoco St	McLoughlin Blvd	\$1,000	Match
U1	Monroe St Neighborhood Greenway (downtown)	Designate as a "neighborhood greenway" and install traffic-calming improvements.	21 st Ave	Hwy 224	\$85	Match
U2	Monroe St Neighborhood Greenway (central)	Designate as a "neighborhood greenway" and install traffic-calming improvements.	Hwy 224	42 nd Ave	\$80	Match
U3	Monroe St Neighborhood Greenway (east)	Designate as a "neighborhood greenway" and install traffic-calming improvements.	42 nd Ave	Linwood Ave	\$165	Match
U5	Stanley Ave Neighborhood Greenway (north)	Designate as a "neighborhood greenway" and install traffic-calming improvements.	Springwater Trail	King Rd	\$135	Match
U6	Stanley Ave Neighborhood Greenway (south)	Designate as a "neighborhood greenway" and install traffic-calming improvements.	King Rd	Railroad Ave	\$195	Match
N	Railroad Ave Capacity Improvements	Bicycle aspect: Fill in gaps in existing bicycle network with bike lanes, cycle track, multiuse path, or other facilities.	37 th Ave	Linwood Ave	\$4,800	Match
AD	Kellogg Creek Bike/Ped Bridge	Construct bike/ped overpass over Kellogg Creek in conjunction with light rail bridge.	Lake Rd	Kronberg Park	\$2,500	Match

⁵ OAR Chapter 660, Department of Land Conservation and Development, Division 012, Transportation Planning, adopted on March 15, 2005, effective April 2005.

Map ID	Project Name	Project Description	From	To	Project Cost (\$1,000s)	Direct Funding or Grant Match
AE	Kellogg Creek Dam Removal and Hwy 99E Underpass	Replace Hwy 99E bridge over Kellogg Creek, remove dam, restore habitat. Construct bike/ped undercrossing between downtown Milwaukie and Riverfront Park.	Location-specific	Location-specific	\$9,900	Match
U4	29 th /Harvey/40 th Neighborhood Greenway	Designate as a "neighborhood greenway" and install traffic-calming improvements.	Springwater Trail	Monroe St	\$220	Match
AC	Kronberg Park Trail	Construct multiuse path to connect bike/ped bridge to safe crossing of Hwy 99E.	Kellogg Creek Bridge	River Rd	\$300	Direct
N/A	Bike Lane Maintenance	Sweep bike lanes to remove debris.	Citywide	Citywide	\$1,200	Direct

REGIONAL TRANSPORTATION PLAN (RTP) COMPLIANCE

The projects identified in the master plan list and further refined in the action plan list are consistent with the Metro 2035 Regional Transportation Plan (RTP). The RTP includes specific goals that can be used to measure the success of regional planning efforts to improve the overall transportation system. Specifically, the master plan and action plan projects identified in this chapter are in line with Metro's goals for regional mobility and non-single-occupant-vehicle (non-SOV) modal targets. Chapter 8 includes a discussion of the performance measures and targets that the City has adopted to achieve the relevant RTP goals.

Three of the goals in the 2035 RTP relate to the regional bicycle system in particular:

- Reduce the number of bicyclist fatalities plus serious injuries by 50% compared to 2005.
- Triple the biking mode share compared to 2005.
- Increase by 50% the number of essential destinations accessible within 30 minutes by trails and bicycling compared to 2005.

All of the master plan and action plan projects identified in this chapter will help the region meet these goals. At the community level in Milwaukie, some of these goals are already met. For example, there is no record of bicyclist fatalities or serious injuries in 2012. And given the relatively compact nature of the city, no destination is more than 30 minutes away by bicycle. Certainly, the strategies outlined in this chapter will allow Milwaukie to contribute further to the region meeting those goals. It is the effort to increase the biking mode share where Milwaukie can play a more active role in meeting the regional goal. As more data and tools become available to help measure local biking mode share, it will become easier to gauge the success of the projects identified in this chapter in increasing that share.

7

Public Transit Element



This chapter summarizes the public transit needs within the city of Milwaukie and recommends improvements for addressing those needs over the next 22 years.

INTRODUCTION

Milwaukie's public transit policies support transportation, land use, economic development, and environmental goals. The availability, convenience and desirability of public transit are key aspects of a system that must support the movement of people to, from, and through Milwaukie. Transit trips reduce single-occupant vehicle trips (which reduces traffic and energy consumption), serve community members who cannot drive (including the elderly, disabled and youth), and minimize transportation system impacts to the environment, such as vehicle emissions and soil and water pollution from impervious surface runoff.

Job creation and retention in the city are also influenced by Milwaukie's transit service. So too are the City's revitalization goals for the downtown, which rest on a moderately dense, mixed use land use pattern. The availability of high quality and dependable transit enables the development of more downtown land for new housing and commercial space with relatively less land being consumed for parking.

TSP GOALS AND POLICY FRAMEWORK

The overall transportation system and the city itself are enhanced as the public transit system improves. Several of the goals of this TSP (see Chapter 2) establish refined policies that assert the importance of transit to the success of the whole transportation system:

- **Goal 1 Livability** calls for a transportation system that is accessible to all members of the community.
- **Goal 3 Provide Travel Choices** directs the City to collaborate with transit providers to improve transit service and to generally support projects that reduce dependence on single-occupant vehicles.
- **Goal 4 Quality Design** requires developers to build appropriate transit-supportive improvements.
- **Goal 6 Sustainability** guides the City to develop an energy efficient transportation system that minimizes environmental impacts.
- **Goal 7 Efficient and Innovative Funding** calls for a cost-effective transportation system.

- **Goal 8 Compatibility** directs the City to coordinate with TriMet and other transit providers to plan for improvements to transit service.
- **Goal 9 Economic Vitality** insists that transportation facilities be built to support the land uses outlined in the Comprehensive Plan, such as the Town Center concept for downtown.

The City's Comprehensive Plan establishes the policy framework for providing transit and integrating it with other transportation modes and adjacent land uses. These policies can be found in the Air, Water and Land Resources Quality Element, Economic Base and Industrial/Commercial Land Use Element, Neighborhood Element and the Transportation, Public Facilities and Energy Conservation Element. The Comprehensive Plan includes several specific directions for guiding the City to a complete transit system, as well as general goal statements and policies toward the same end. In sum, the policies are:

- **Travel-Related:** Reduction of congestion, improved connectivity between Milwaukie and Portland.
- **Access-Related:** Accommodation of elderly and disabled citizens, service to all neighborhoods, pedestrian and bicycle connections to transit stops and routes.
- **Land-Use-Related:** Increased density of housing and jobs near transit facilities.
- **Transit-Experience-Related:** Ensure transit facilities are safe, well-maintained, and convenient.
- **Environment-Related:** Reduction of regional air pollution and development of a compact, walkable downtown.
- **Planning-Related:** Require new development to provide transit amenities as appropriate, prioritize street improvements on transit streets, coordinate on regional transit initiatives including high-capacity transit planning and coordinate with TriMet on service delivery and facility improvements.

The TSP affirms these goals, and supports them by identifying system deficiencies and needs, new service enhancements, capital improvements and policy improvements.

NEEDS

The public transit system in Milwaukie must achieve four goals for it to be a complete system. A complete transit system in Milwaukie would provide or allow for:

1. Service for the greatest number of potential users.
2. Service for the neediest citizens.
3. A safe experience for all users.
4. Convenient service.

Public Transit Coverage and Service

TriMet is the regional transit provider for the Portland metro area and provides transit service to and from Milwaukie, with ten bus routes: 28, 29, 31, 32, 33, 34, 70, 75, 99, and 152. These routes, their approximate headways (time between arrivals), and the locations of stops, shelters, and the transit center and park-and-rides are shown in Figure 7-1.

The preponderance of transit needs in Milwaukie can be divided into two categories: new service (where there isn't any today) and enhanced services (where more service is desired). As described in Figure 7-1, most of Milwaukie currently enjoys nearby bus service. Ten bus routes currently run through the city, with buses making frequent stops and providing most of the city's neighborhoods with weekday service. The exceptions are in portions of the Hector Campbell,

Linwood, and Lewelling neighborhoods (shown in red on Figure 7-1) which have pockets that are outside a 1/4-mile walk distance to the nearest bus stop. These portions of Milwaukie, which comprise approximately 15% of its land area, will only be served with the establishment of new, proximate bus routes and stops.

Figure 7-2 illustrates the second category of need, showing how service levels drop on existing routes during the weekend when the same criteria are applied (1/4-mile walk distance to nearest bus stop). Because five of the ten bus lines do not run on the weekend, nearly the entire southern half of the city is left without convenient bus service. Even during periods of maximum service (called peak times), several lines do not run frequently enough to meet the needs of the Milwaukie transit users.¹ During peak hours, only six of the ten bus routes operate with headways of 30 minutes or less, while the remaining five lines operate with headways greater than 30 minutes.

¹ Headways have been criticized, for example, as being too great (i.e. too much waiting) for the routes serving Lake Rd, Oatfield Rd, and Harvey St.



Transportation System Plan

FIGURE 7-1

PEAK HOUR TRANSIT COVERAGE

November 2013

LEGEND

Transit Facilities

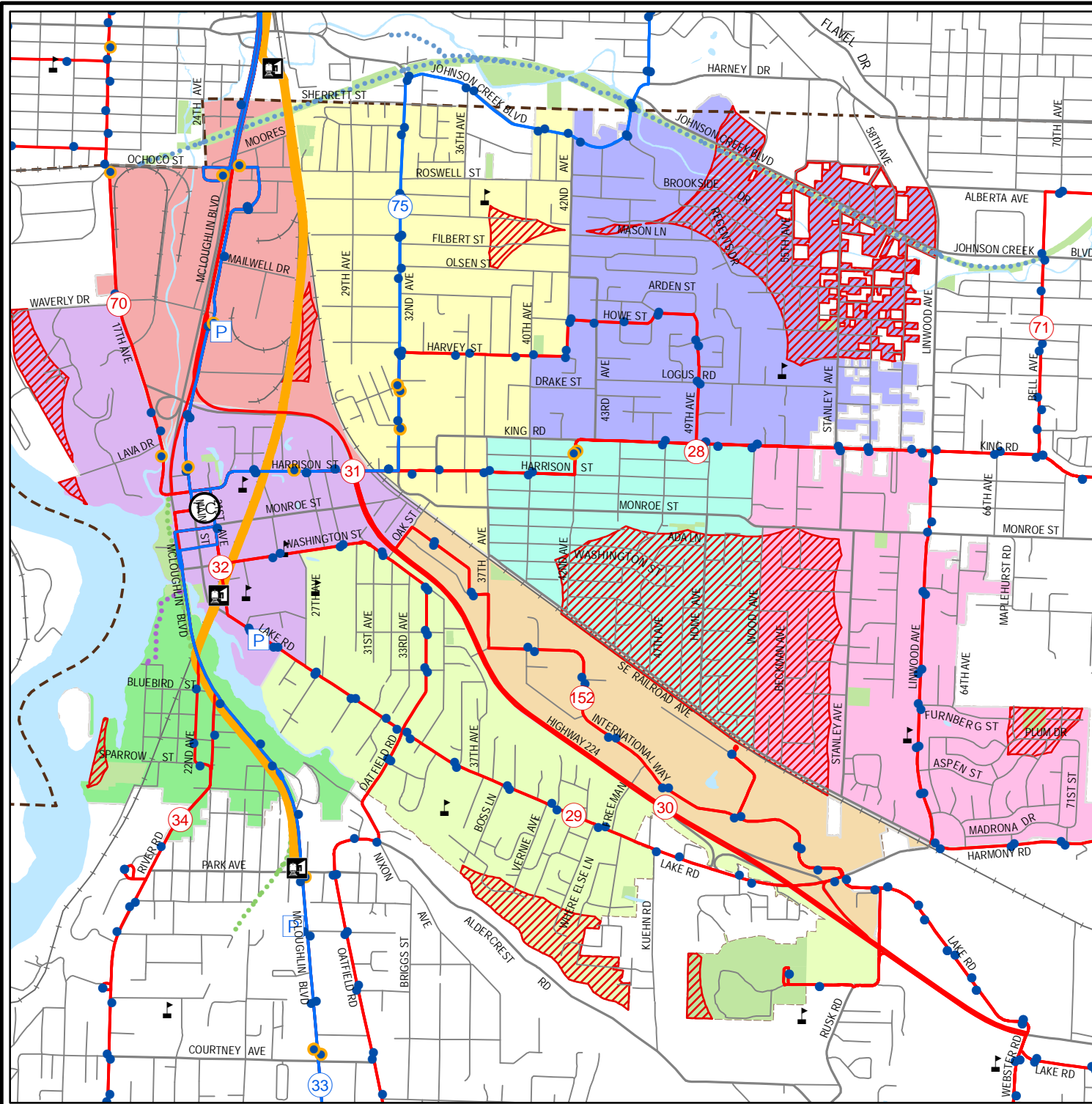
- > 1/4 Mile Walk to Bus Stop during Peak Operating Hours
- Bus Routes < 30 Min. Frequency
- Bus Routes > 30 Min. Frequency
- Stop
- Shelter
- Light Rail Station
- Light Rail Transit
- Park-and-Ride
- Transit Center

Neighborhood District Associations

- ARDENWALD
- HECTOR CAMPBELL
- HISTORIC MILWAUKIE
- ISLAND STATION
- LAKE ROAD
- LEWELLING
- LINWOOD
- MCLOUGHLIN INDUSTRIAL
- MILWAUKIE BUSINESS INDUSTRIAL

Other Map Features

- Schools
- Kellogg Creek Trail
- Springwater Trail
- Trolley Trail
- Major Roads
- Streets
- Railroad
- County Line
- Water
- Parks
- City Limits



DKS Associates
TRANSPORTATION SOLUTIONS



0 500 1,000 2,000 3,000 4,000 Feet



Transportation System Plan

FIGURE 7-2

OFF-PEAK TRANSIT COVERAGE

November 2013

LEGEND

Transit Facilities

- Bus Routes, Off-Peak Hours < 60 Min. Frequency
- Bus Routes, Off-Peak Hours 60 Min. Frequency
- Stop
- Shelter
- Light Rail Transit
- Light Rail Station
- Transit Center
- Park-and-Ride
- > 1/4 Mile Walk to Bus Stop during Off-Peak Operating Hours

Neighborhood District Associations

- ARDENWALD
- HECTOR CAMPBELL
- HISTORIC MILWAUKIE
- ISLAND STATION
- LAKE ROAD
- LEWELLING
- LINWOOD
- MCLOUGHLIN INDUSTRIAL
- MILWAUKIE BUSINESS INDUSTRIAL

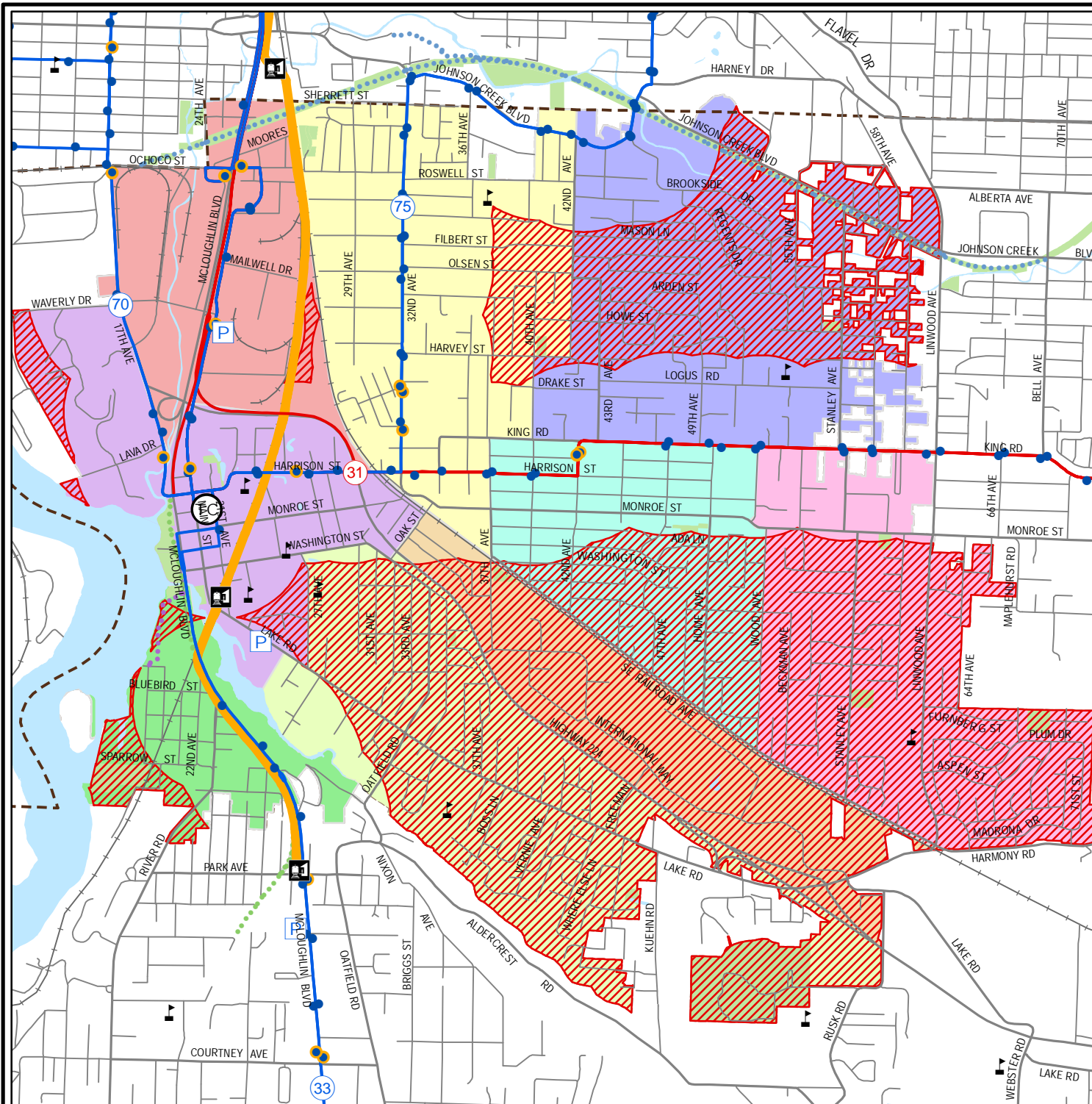
Other Map Features

- Schools
- Kellogg Creek Trail
- Springwater Trail
- Trolley Trail
- Major Roads
- Streets
- Railroad
- County Line
- Water
- Parks
- City Limits

DKS Associates
TRANSPORTATION SOLUTIONS



0 500 1,000 2,000 3,000 4,000 Feet



Public Transit Supportive Facilities

Many TriMet facilities in Milwaukie are in need of improvement. Certain bus stops are perceived as unsafe, either because of their proximity to unpleasant site or traffic conditions, isolated location, low ridership, lack of supporting nearby land uses, or neglected physical condition..

Park-and-ride facilities in the city are insufficient for Milwaukie commuters, causing these commuters to seek parking downtown or on neighborhood and collector streets, or to dispense with transit options entirely. Bike parking facilities are also reported as inadequate at existing park-and-rides.

Gaps in city facilities, especially sidewalks, contribute to underutilization of the transit system. Every transit user is a pedestrian, since many people arrive at bus stops on foot, and all wait for buses in the pedestrian realm. While the transit system does not require sidewalks on every street in the city, it is vastly improved when sidewalks are provided on both sides of streets with bus stops, and at least one sidewalk on local streets that connect to transit stops. Good lighting is essential for safety and visibility.² Finally, the City should maintain clear striping of bike lanes where bus routes and bike routes are co-located on a street (although this situation should be avoided where possible).

The new Portland-Milwaukie Light Rail (PMLR) line, scheduled to open in 2015, represents a new transit facility that will connect Milwaukie with downtown Portland. The new line will run from the Portland State University campus at SW 6th Ave and College St, through the South Waterfront area (with a direct link via aerial tram to the Oregon Health & Science University) and across the Willamette River to the Oregon Museum of Science & Industry, and south alongside McLoughlin Blvd to downtown Milwaukie, terminating at SE Park Ave.

System Deficiencies

Though transit service in Milwaukie needs to be improved in many ways, its greatest deficiencies are in the areas of Service Levels, Safety, and Convenience of Service. Several factors contribute to this perception and point to the community's desired areas of improvement:

- New routes are needed to serve the Hector Campbell, Linwood and Lewelling neighborhoods where the nearest bus stops are more than a 1/4-mile walk away. This is an environmental justice issue as well as a livability issue for people living in these transit-deficient pockets.
- Additional runs (i.e. increased frequencies or shorter headways) are needed for many routes, especially on evenings and weekends.
- Bus shelters or improved shelters and related features are needed for certain locations, notably where daily boardings exceed TriMet's standards for shelter upgrades.
- Shelters at main stops along bus routes need adequate lighting and TransitTracker³ information.

² Bus stop lighting is typically provided by nearby streetlights, if the street is well lit. However, nighttime illumination can still be poor or nonexistent, and the cost of hard-wiring bus stops with lights is significant and impractical in many locations. TriMet has recently started to install solar lighting systems primarily along frequent bus corridors, using environmentally friendly LED (light emitting diodes) inside select shelters. The city should work with TriMet to have these systems installed where needed in Milwaukie.

³ "TransitTracker" is the name of TriMet's Global Positioning System technology for tracking how far a bus or MAX train is from a stop. This real-time information is then made available to riders on the street via electronic displays installed in bus shelters and MAX stations, online, or over the phone. "Transit Priority Intersections" enable

- The downtown Transit Center needs to be "dissolved" by establishing a bus layover facility somewhere outside of the downtown.
- More park-and-ride parking lots are needed in certain locations.
- Bus rapid transit is needed for routes to connect with Oregon City and Clackamas Town Center.
- Coordination between bicycle facilities and transit services is needed.
- The expansion of Milwaukie's sidewalk system needs to consider the importance of sidewalks on transit streets and local streets adjacent to transit streets.
- Convenient service needs to serve Milwaukie's significant elderly population.

RECOMMENDATIONS

The City's policies on public transit, compared to the current state of the system, reveal a disparity between the City's goals for transit service and use, and the system's ability to meet those goals today. To close this gap, the City and TriMet should simultaneously pursue three types of improvements that will increase transit service and benefit Milwaukie residents, employees, and the greater population:

- **Service Enhancements:** Make transit more convenient for users through new routes and stops, and enhanced service on established routes.
- **Capital Improvements:** Enhance the transit experience for users. These improvements take the form of capital projects that upgrade transit facilities in the city (e.g. shelters, bus stops, park-and-rides).
- **Policy Improvements:** Establish new policies or policy direction that clarifies and expands how the City can help facilitate transit use and a transit experience that better meets the needs of local system users.

The City and TriMet are collaborators in making these improvements, although their relative interests and authorities are shared in differing proportions for each. Service Enhancements are largely in TriMet's control, with the City providing direction and little else. Policy Improvements have the opposite character, as these are within the City's realm of authority, with the transit agency providing input. Implementation of Capital Improvements is more equally shared, with the two entities working closely together to select and construct the improvements with funds from either government or a third party grantor to which either or both governments may apply.

A complete list of all three improvement types is included as Table 7-1, Public Transit Master Plan Projects, located at the end of this chapter. The high priority Service Enhancement and Capital Improvement projects are illustrated in Figure 7-3, also located at the end of this chapter. The high priority recommendations are also summarized below.

Service Enhancements

TriMet's service enhancements are determined through its five-year Transit Investment Plan (TIP), which lays out the agency's strategies and programs to meet regional transportation and livability goals. The Regional Transportation Plan and local transportation system plans guide

preferential treatment of buses at intersections by extending the green time along the bus route, or actuating the green light at intersections upon detection of an approaching bus.

the TIP, which is updated annually and seeks to meet current and future demands for service. Through its TIP updates, TriMet partners with jurisdictions like Milwaukie to develop criteria for expanding transit service. The City should coordinate with TriMet on the annual TIP update process on the programming of Milwaukie's desired service enhancements.

Two new east-west bus routes are envisioned for Milwaukie: one utilizing Johnson Creek Blvd east of 42nd Ave, and one utilizing Railroad Ave. The Johnson Creek line would extend to 82nd Ave to serve the numerous jobs between 42nd and 82nd Aves and connect with the I-205 light rail (MAX) line. The Railroad Ave route would require a complete upgrade of the street itself, with sidewalks, stormwater drainage, and bus shelters. The route is envisioned to connect to the east with Harmony Rd, to serve Clackamas Community College, Clackamas Town Center and the eastern suburbs. Downtown Milwaukie is envisioned as the western terminus for the new line (see Figure 7-3).

A third east-west service enhancement—bus rapid transit—is requested for the Line 31 rush hour route, which utilizes Hwy 224. The opening of the I-205 light rail in 2009 has increased the need for TriMet to consider converting this part-time route to high-frequency service, subject to available funding for operations and bus fleet expansion.

Service enhancements for north-south routes include conversion of Lines 33 and 99 in the McLoughlin Blvd corridor to high-frequency light rail service (with continued high-frequency non-light-rail transit to Oregon City) and extending service on Linwood Ave north of King Rd, continuing on Flavel Dr into Portland. There may be a need for a circulator bus to connect light rail riders to employment locations south of the Tacoma St area when Lines 33 and 99 are discontinued.

In general, more service is desired on existing routes. Reduced headways (more frequent bus runs) are desired for the routes serving Lake Rd, Oatfield Rd, Linwood Ave, International Way, and Logus Rd. Additionally, weekend service is desired for more routes, including those serving King Rd, Oatfield Rd, McLoughlin Blvd, 17th Ave, and 32nd Ave.

Other service enhancements would improve the reliability and/or ridership on Milwaukie transit routes. These include extending the hours of service for certain routes (e.g. between 6 p.m. and 10 p.m.), adding TransitTracker technology at more stops, and establishing transit priority intersections along transit corridors. Where TriMet can improve its system efficiencies and operations, for instance through signal prioritization, interlining routes, curb extensions and other similar devices, the City will provide willing consultation and collaboration. The City acknowledges that the transit system is a regional entity and that service enhancements that benefit the overall system are generally a benefit to the City's small piece of the system.

Capital Improvements

Capital improvements within Milwaukie can be thought of as user amenities that improve the convenience and attractiveness of the transit system, which in turn bolsters ridership. Typical examples of capital improvements include park-and-rides, bus shelters, attractive signage with timetable information, benches, bike racks, trash receptacles, and public art.

The selection of capital improvements depends on needs and availability of funds. TriMet prioritizes bus stop upgrades, for example, based on the number of boardings at the location, the type of service provided at the location (e.g. local bus, express bus, frequent bus, MAX, etc.) and special circumstances such as the presence of a nearby senior center.

Most of the bus stops in Milwaukie are considered "basic stops," and currently have minimal amenities (poles with signs only and a schedule display). TriMet typically provides a shelter at a

bus stop that sees an average of 35 daily boardings.⁴ Based on 2006 boarding data, there is one stop in Milwaukie that should have a shelter but does not: Harrison St/24th Ave.⁵ This stop should be upgraded to a shelter.

Park-and-ride lots are very valuable for commuters. There is currently one small shared-use park-and-ride in Milwaukie, located south of downtown on Lake Rd. This type of small, shared use park-and-ride is useful for residents making short car trips to connect with local bus service.

A second park-and-ride, the 300-plus-space Southgate park-and-ride was constructed in 2008 and is located north of Hwy 224 and east of McLoughlin Blvd. This type of park-and-ride is designed for regional use, attracting users from farther distances who are often seeking to connect with higher capacity transit service like frequent service bus, or light rail. When Lines 33 and 99 are discontinued after the start of light rail service to Milwaukie, consideration should be given to converting the Southgate park-and-ride for use as local employee parking.

Additional park-and-ride lots of both types should be considered for better serving Milwaukie commuters and Clackamas County commuters bound for Portland.

A downtown park-and-ride is a special case. A park-and-ride structure downtown could serve both local and regional transit users, as well as downtown employees and visitors. A structure of this type is envisioned to support the PMLR, but under a special set of circumstances that would allow the City to share the facility for public parking, eventually phasing out the commuter parking as downtown Milwaukie develops (see Chapter 12 Downtown Parking). This option will require additional research regarding location and funding options.

Policy Improvements

By adopting policies that reinforce its transit goals and the improvements described in this TSP update, the City reaffirms its commitment to a complete transit system and takes new steps toward realizing that vision.⁶ Key policy recommendations are described below. Other policy suggestions, each contributing toward establishing the complete system, are summarized in "Other Transit Policies."

Serve the "Transit Disadvantaged" Portions of Milwaukie

One high priority policy is the elimination of "transit disadvantaged" portions of the city, based on weekday peak-hour service, by providing new transit service for these areas. The City's Comprehensive Plan establishes that the transportation system provide travel choices and allow people to reduce the number of trips made by single-occupant vehicles.⁷ This policy bolsters the City's position that underserved areas be the focus of new transit investments.

⁴ Although ridership is the primary criterion for determining shelter placement warrants, TriMet also considers other factors like LIFT service usage, funding and maintenance by others, development of adjacent property and opportunities for consolidating bus stops.

⁵ The Linwood/King stop currently has 29 daily boardings, according to TriMet. The City and TriMet should track the data for this stop on an annual or semiannual basis given the intensification of land use at the Wichita Shopping Center in 2007.

⁶ The term "reaffirm" is emphasized here. The City of Milwaukie currently enacts several important transit-supportive policies and provisions located elsewhere in this TSP, in the Milwaukie Municipal Code (Subsection 19.504.10) and the Comprehensive Plan. These include goals such as street connectivity (which enables bus routes and pedestrian access from neighborhood to transit streets), safe pedestrian crossings at regular intervals along principal roadways, development standards that implement State Transportation Planning Rule requirements for building entrances that face transit streets (not parking lots), and appropriate levels of density along transit streets to support transit use.

⁷ This policy is included in the Comprehensive Plan as Goal 3 Travel Choices.

Provide Park-and-Rides Downtown and on Milwaukie's Fringe

Park-and-ride policies are suggested that would facilitate structured parking in downtown (see Downtown Parking chapter), and guide the size of new park-and-rides in other locations—smaller within the city to serve Milwaukie residents, and larger on the city's fringe to serve North Clackamas County commuters. These "fringe" park-and-rides, if associated with light rail, (such as that under study for Park Ave and McLoughlin Blvd) should be annexed to the City of Milwaukie to ensure effective and efficient policing.

Improve Public Transit Safety

The Milwaukie Police Department should be consulted and enlisted in the effort to ensure passengers' sense of safety at and on all TriMet facilities in the city. A policy should be adopted that specifically discourages loitering at transit facilities.

Maintain Public Transit Facilities

The maintenance of transit facilities can be improved through the enlistment of city neighborhoods, through a policy that would enable Neighborhood District Associations to initiate improvements by contacting TriMet directly. The transit agency would, in turn, commit to make best efforts to complete the needed maintenance or repair.

Request Dedication for Bus Stop Improvements

The City already requires easements or dedications for new or upgraded bus stops when an adjacent site applies for land use or development permits. Where desired bus stop improvements are adjacent to sites being developed or redeveloped for which an easement or dedication is not required, City policy should be updated to ensure that easements or dedications are requested of project developers and property owners.⁸ The NDAs can be effective advocates for the transit system in this process.

Reinvest Public Transit "Savings" Within Milwaukie

The city's level of transit service, while high, falls well short of achieving the goals of the community and the Comprehensive Plan. Consequently, the City takes the position that any savings derived from new capacity, (either through light rail, bus rapid transit, or other new enhancement) be contained and reinvested within the Milwaukie service area. The City would prefer that investments in service upgrades not all come in the form of route conversions to high-frequency transit. Although these conversions are supported, the City's preference would be that savings associated with these conversions (from eliminated bus operations, for example), be retained and reinvested in needed bus system enhancements elsewhere in town. The ultimate goal of this policy would be to achieve a net gain of distributed service throughout the city—both through new projects like light rail, and increased bus service as a result of the new projects.

Other Public Transit Policies

- **Shared Use Park-and-Ride Facilities:** Explore the use of local church parking lots as park-and-ride facilities, in conjunction with a policy to suitably size these facilities based on their location.
- **Frequency of Service:** Add a policy to increase headways on all transit routes in the city so that buses run at least every 30 minutes.

⁸ Frequently TriMet is unable to improve bus stops because the property required to make the improvement is privately owned.

- **Bike/Bus Connection:** Identify priority intersections for making connections between bike and bus transportation modes. Ensure that bike parking is installed at all park-and-ride facilities.
- **East-West Travel:** Add a policy that recognizes the need for east-west transit travel south of downtown Portland. Center-to-center commuting is an example of east-west travel.
- **Equitable Ticket Pricing:** Add a policy to ensure that ticket prices from park-and-rides south of downtown are the same as those north of downtown.
- **Interagency Coordination:** Continue to support the Milwaukie Center Bus Service and TriMet's LIFT service through interagency referrals, coordination, and signage as necessary.

Master Plan

TriMet's TIP includes many new services expansions in Milwaukie and the surrounding area over the next 22 years. The Public Transit Master Plan includes potential improvements identified by the transit working group, which included participation from TriMet. Table 7-1 summarizes the transit master plan for both capital projects and service enhancements.



Transportation System Plan

FIGURE 7-3

PUBLIC TRANSIT MASTER PLAN

November 2013

LEGEND

Existing Facilities

- Bus Route Number
- Bus Stop
- Bus Route
- Light Rail Station
- Light Rail Transit
- Park-and-Ride

Proposed Improvements

- Park-and-Ride
- New or Rerouted Bus Route
- Bus Rapid Transit Route

Other Map Features

- Schools
- Major Roads
- Streets
- Railroad
- Kellogg Creek Trail
- Springwater Trail
- Trolley Trail
- County Line
- Water
- Parks
- City Limits



DKS Associates
TRANSPORTATION SOLUTIONS

0 500 1,000 2,000 3,000 4,000 Feet

Table 7-1 Public Transit Master Plan Projects

Priority	Type	Project Name	Project Description	From	To	Cost (\$1,000s ⁹)
High Priority Projects						
High	C	Downtown Transit Center Improvements	Construct new bus layover facility outside of the downtown core.	Location-specific	Location-specific	\$1,250
High	SE	Railroad Ave Capacity Improvements	Transit aspect: Provide bus service to extend to Clackamas Town Center and points east.	Harrison St	Eastern city limits	TBD
High	SE	Johnson Creek Blvd Bus Service	Identified bus route need.	45 th Ave	Eastern city limits	TBD
High	SE	Park-and-Ride Bus Service	Reroute bus line #70 to serve the Milwaukie park-and-ride on Main St.	Location-specific	Location-specific	TBD
High	O	Milwaukie Transportation Management Association Program	Implement a transportation management association for downtown employers.	Milwaukie Town Center	Milwaukie Town Center	\$200
High	SE	Downtown Loop Bus	Establish bus service from downtown to Tacoma and Park Ave stations.	Downtown	Tacoma station, Park Ave station	TBD
High	SE	Neighborhood Loop Bus	Establish bus service between eastern neighborhoods and downtown.	Eastern city limits	Downtown	TBD
Medium Priority Projects						
Med	C	Harrison St Transit Shelter at 24 th Ave	Install transit shelter at Harrison St and 24 th Ave, as this stop currently meets minimum boarding requirements.	Location-specific	Location-specific	\$5
Med	SE	Weekend Service Improvements	Increase weekend bus service on bus lines #31, #32, #33, #70, and #75.	Citywide	Citywide	TBD
Low Priority Projects						
Low	C	Bike Lane Striping	Restripe existing bike lanes and stripe bike lanes on bus routes where buses and bicyclists share the road.	Citywide	Citywide	\$20
Low	C	Bus Shelter Safety Improvements	Add TransitTracker and LED lighting units at main stops along bus routes.	Citywide	Citywide	TBD
Low	C	Hwy 224 Rapid Bus Improvements	Construct improvements that enhance rapid bus service east to Clackamas Town Center.	Milwaukie Town Center	Clackamas Town Center	TBD

⁹ Project costs are order-of-magnitude estimates and are in 2012 dollars. Future costs may be more due to inflation. In the case of operational projects, estimated costs are for the entire 22-year planning period.

Priority	Type	Project Name	Project Description	From	To	Cost (\$1,000s ⁹)
Low	SE	Linwood/Flavel Bus Service	Identified bus route need.	Northern city limits	King Rd	TBD
Low	SE	Bus Line Service Improvements	Add frequent service to bus line #31. Add more runs to bus lines #152, #32, and #33 between 6pm and 10pm.	Location-specific	Location-specific	TBD
Low	SE	Transit Priority Signalization	Implement transit priority signalization along key transit corridors.	Citywide	Citywide	TBD
N/A	C	McLoughlin Blvd Rapid Bus Improvements	Construct improvements that enhance rapid bus service south to Oregon City.	Milwaukie Town Center	Oregon City Town Center	TBD

Notes:

C = Capital Project

High = High priority

SE = Service Enhancements

Med = Medium priority

P = Policy Project

Low = Low Priority

TBD = Costs to be determined. These projects are under the jurisdiction of and/or will be funded by TriMet.

Action Plan

The Public Transit Action Plan identifies the highest priority projects that are reasonably expected to be funded with local funds by 2035, which meets the requirements of the State's Transportation Planning Rule.¹⁰ The action plan project list is based upon a 2007 citywide project ranking process. In 2007, all of the modal master plan projects were ranked by the TSP Advisory Committee after consideration of the Working Groups' priorities, other public support for the project, and how well each project implements the TSP goals and policies. For the 2013 TSP Update, City staff reassessed the prioritization of all projects, incorporating public comments gathered at and around a public meeting in June 2013. Action plan projects that were completed since 2007 were removed from the action plan and new projects identified as top priorities were added.

Table 7-2 Public Transit Action Plan

Project Name	Project Description	From	To	Project Cost (\$1,000s)	Direct Funding or Grant Match
Downtown Transit Center Improvements	Construct new bus layover facility outside of the downtown core.	Location-specific	Location-specific	\$1,250	Match
Railroad Ave Capacity Improvements	Provide bus service to extend to Clackamas Town Center and points east.	Harrison St	Eastern city limits	TBD	Direct (TriMet)
Downtown Loop Bus	Establish bus service from downtown to Tacoma and Park Ave stations.	Downtown	Tacoma station, Park Ave station	TBD	Direct (TriMet)
Neighborhood Loop Bus	Establish bus service between eastern neighborhoods and downtown.	Eastern city limits	Downtown	TBD	Direct (TriMet)

REGIONAL TRANSPORTATION PLAN (RTP) COMPLIANCE

The projects identified in the master plan list and further refined in the action plan list are consistent with the Metro 2035 Regional Transportation Plan (RTP). Specifically, the projects identified are in line with Metro's goals for regional mobility and non-single-occupant-vehicle (non-SOV) modal targets.

¹⁰ OAR Chapter 660, Department of Land Conservation and Development, Division 012, Transportation Planning, adopted on March 15, 2005, effective April 2005.

8

Street Network Element



The Street Network element of the TSP focuses on maintaining traffic flow and mobility on arterial and collector roadways, protecting residential neighborhoods from excessive through traffic and travel speeds, providing reasonable access to and from residential areas, improving safety, and promoting efficient through-street movement. This chapter summarizes strategies used to evaluate the future needs of Milwaukie's street network, and recommends projects to improve the operations of the motor vehicle system (for automobiles, trucks, buses, and other vehicles).

TSP GOAL AND POLICY FRAMEWORK

Milwaukie has developed a set of goals to guide the development of its transportation system (see Chapter 2). Several of these TSP Goals guide the City's policies on auto mobility and access, and street connectivity, specifically the following:

- **Goal 1 Livability** directs the City to protect residential areas from excessive speed, and minimize the "barrier" effect transportation facilities have on the community.
- **Goal 2 Safety** calls for the use of coordinated street design standards and access control measures.
- **Goal 3 Travel Choices** directs the City to integrate pedestrian and bicycle facilities into existing and new roadways.
- **Goal 4 Quality Design** addresses the need to relate the design of a street to its intended users.
- **Goal 5 Reliability and Mobility** directs the City to enhance street connectivity and maintain traffic flow, especially on arterials and collectors.
- **Goal 7 Efficient and Innovative Funding** calls for an emphasis on maintaining existing facilities.

FUNCTIONAL CLASSIFICATION

Any discussion of the City's street network should begin with the definition of the different types, or functional classifications. Functional street classifications encompass both the design characteristics of streets and the character of service the streets are intended to provide. The City's functional classifications form a hierarchy of streets ranging from those that are primarily for travel mobility (arterials) to those that are primarily for access to property (local streets). The functional classification system is developed with the recognition that individual streets do not act independently of each other but form a network of streets that work together to serve travel needs on a local, citywide and regional level.

These classifications guide design standards, levels of access, traffic control, law enforcement, and the provision for federal, State, and regional transportation funding. The City's functional classification system includes regional routes, arterials, collectors, neighborhood routes, and local streets. Figure 8-1 shows current functional classifications, including a few small changes from the last TSP update in 2007. Specifically, due to construction of the Portland-Milwaukie Light Rail (PMLR) alignment through downtown, the classification of Lake Rd between 21st Ave and Main St has been changed from "arterial" to "local," the classification of Main St between Lake Rd and Washington St has been changed from "collector" to "local," and the section of Adams St between Main St and 21st Ave has been changed from a "collector" street to not being a street (that section is permanently closed to vehicular traffic). Table 8-1 describes the general characteristics and functions of each of these classifications.



Transportation System Plan

FIGURE 8-1

FUNCTIONAL CLASSIFICATION

November 2013

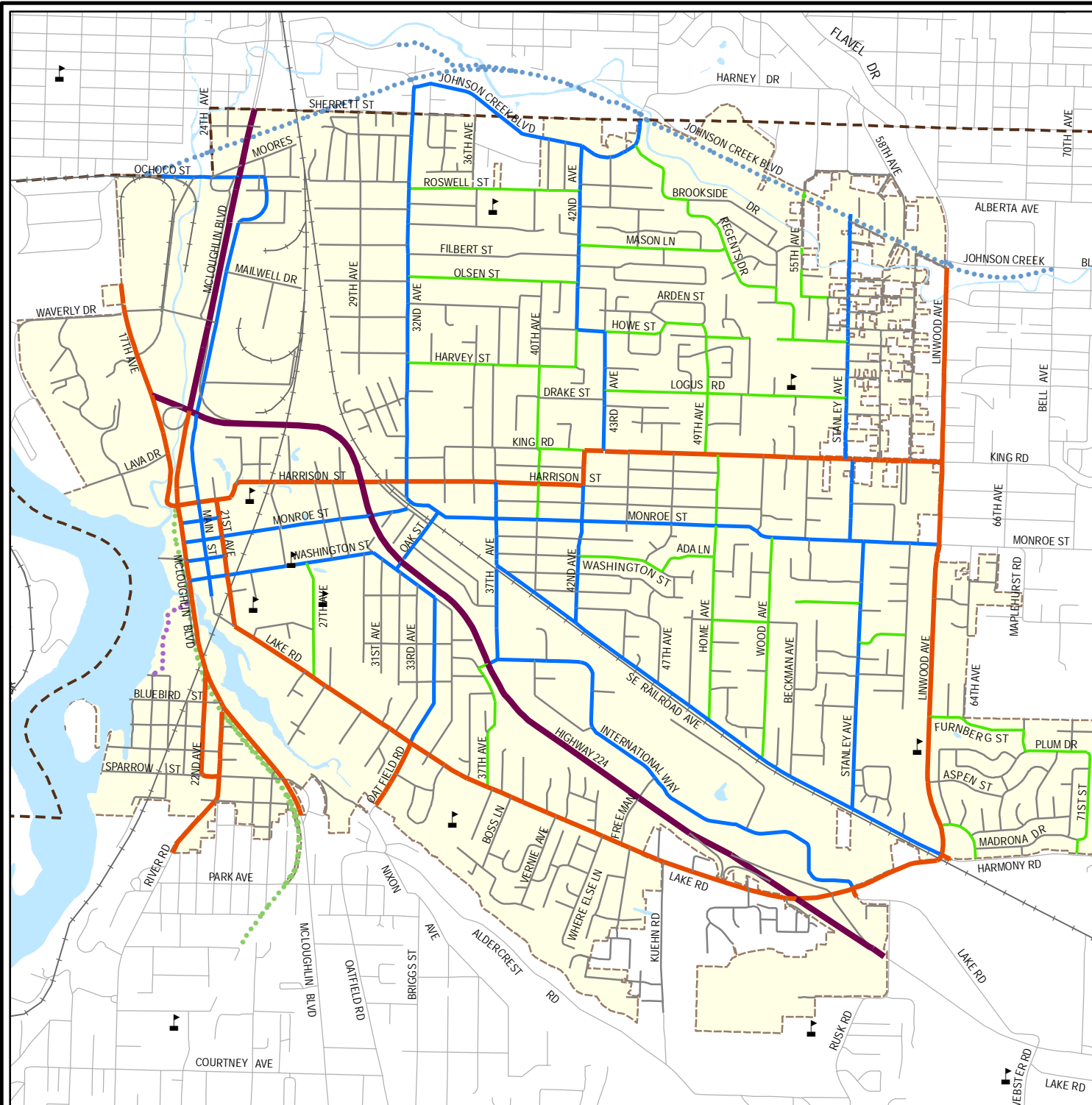
LEGEND

Functional Classification

- Regional Routes
- Arterials
- Collectors
- Neighborhood Routes
- Local Streets

Other Map Features

- Schools
- Kellogg Creek Trail
- Springwater Trail
- Trolley Trail
- Railroad
- County Line
- Water
- City Limits



DKS Associates
TRANSPORTATION SOLUTIONS



0 500 1,000 2,000 3,000 4,000 Feet

Table 8-1 City of Milwaukie Functional Classifications

Classification	Description	Typical Total Vehicles per Day	Typical Number of Lanes	Other Street Elements
Regional Routes	<ul style="list-style-type: none"> • High volume, generally high-speed facilities. • May be used for travel within the city, but typically they are used for trips between cities, especially those that are separated by a significant distance. • Rank high on the mobility scale because they have multiple travel lanes in both directions and limited access points. • Rank low on the access scale because access to private property is generally prohibited. • The City's regional route designation matches the regional definition of these roads by Metro and ODOT. 	20,000	4 or more	
Arterials	<ul style="list-style-type: none"> • High volume, moderate speed streets that carry vehicles within the city and between adjacent cities in the surrounding metropolitan area. • Some are under the jurisdiction of and/or maintained by other agencies, such as ODOT, Clackamas County, and the City of Portland. • Rank high on the mobility scale but also provide limited access to a wide range of land uses. • Link major commercial, residential, industrial, and institutional areas. • Typically spaced about one mile apart to assure mobility and reduce the incidence of cut-through traffic on neighborhood routes and local streets. • Management objective is to provide for safe and efficient traffic flow along with pedestrian and bicycle movements. Within downtown, local access is a priority. 	10,000	3 or more	Bicycle lanes and sidewalks
Collectors	<ul style="list-style-type: none"> • Moderate volume, moderate speed streets that provide access and circulation within and between residential neighborhoods, commercial areas, and industrial areas. • Serve a citywide function of connectivity and are typically spaced about 1/2 mile apart. • Distribute trips between the neighborhood street system and the arterial street system, linking a wide range of land uses. • Access control for collectors is not as high a priority as for arterials, but is especially needed near street intersections. • Since collectors often traverse residential neighborhoods, neighborhood traffic management measures are often needed to manage traffic impacts through these areas. 	5,000-10,000	2-3 ¹	Bike lanes or shared roadway; sidewalks

¹ As a result, these streets are likely to need turn lanes at some intersections or center left-turn lanes as volumes approach 10,000 vehicles per day.

Classification	Description	Typical Total Vehicles per Day	Typical Number of Lanes	Other Street Elements
Neighborhood Routes	<ul style="list-style-type: none"> Moderate volume, low speed streets. Do not provide citywide circulation, as they mainly serve the immediate neighborhood in which they are located. Typically have residential frontage. Connect neighborhoods to collectors and arterials. Neighborhood routes are similar to local streets in design, but they are generally longer in length and have higher traffic volumes. In order to retain the neighborhood character and livability of these streets, additional design treatments in the form of traffic management devices are often needed to manage traffic volume impacts. 	1,500 to 5,000	2	Shared roadway, sidewalks, on-street parking
Local Streets	<ul style="list-style-type: none"> Low volume, low speed streets that emphasize access to adjacent land uses over mobility. All streets that are not regional routes, arterials, collectors or neighborhood routes are classified as local streets. Connect neighborhoods to collectors and arterials Most local streets are adjacent to residential uses and serve residential transportation needs; however, there are a number of local streets that exclusively serve the city's two industrial areas. Local streets rank high on the access scale, so driveways and intersections are more closely spaced than on other types of streets. 	Less than 1,500	2	Shared roadway, pedestrian facilities, on-street parking.

The design of a roadway can vary from segment to segment due to adjacent land uses and demands, the objective is to have a standard that defines key characteristics provides consistency, and also defines application criteria to provide the flexibility needed to suit conditions. Street design standards and options are discussed in further detail in Chapter 10 Street Design.

TRANSPORTATION NETWORK NEEDS

This section identifies the study area deficiencies for the 2035 baseline scenario, which only includes transportation system improvements that have committed funding (such as STIP and CIP) to be constructed and implemented as a "low build" condition. The increase in vehicle volume as forecasted by the 2035 Metro RTP ("low build") travel demand model and resulting intersection operations are also summarized.

2035 Baseline Network Assumptions

The 2035 base case scenario includes transportation improvements that are reasonably expected to be funded and constructed by the year 2035.² This scenario includes both the Transportation Demand Management (TDM) improvements identified later in this chapter and a subset of capacity projects identified in the Regional Transportation Plan (RTP) financially constrained system, shown below in Table 8-2.

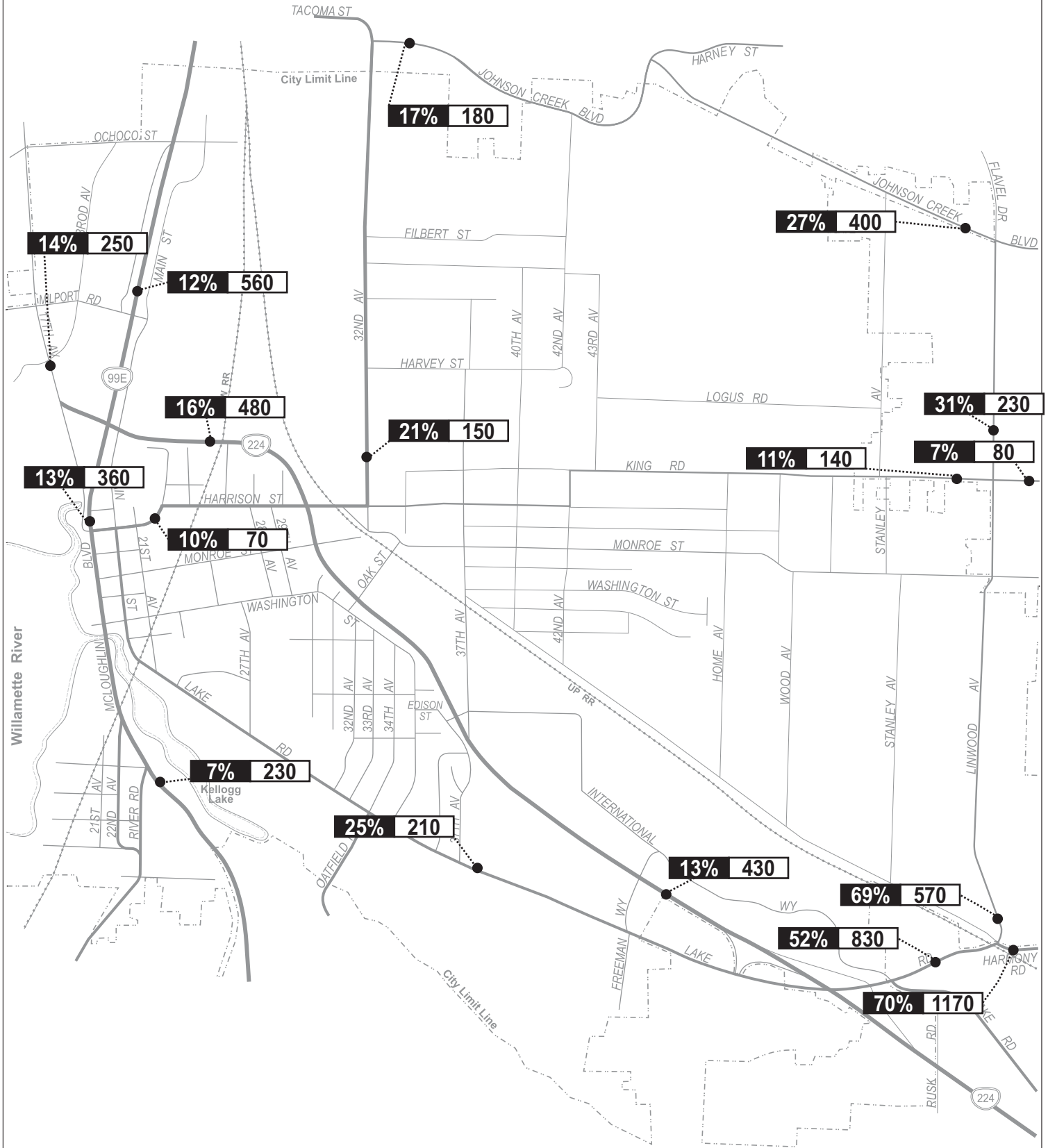
² Forecasting for the 2035 base case scenario takes into consideration PMLR as a factor as part of the region's transportation system.

Table 8-2 RTP Financially Constrained Motor Vehicle Capacity Improvements

RTP Project #	Location	Improvement	Jurisdiction	Timeline	2007 Cost (\$1,000s)
10002	Johnson Creek Blvd (45 th Ave to 82 nd Ave)	Widen from 3 to 5 lanes and widen bridge over Johnson Creek	Clackamas Co.	2018-2025	\$30,000
10003	Harmony Rd (Hwy 224 to 84 th Ave)	Widen to 3 lanes with bike lanes and sidewalks where needed	Clackamas Co.	2008-2017	\$20,000
10005	West Monterey (82 nd Ave to Fuller Rd)	New two-lane extension	Clackamas Co.	2018-2025	\$6,200
10009	Fuller Rd (Otty Rd to Johnson Creek Blvd)	Widen Street and add turn lanes, sidewalks, on-street parking, central median, and landscaping	Clackamas Co.	2008-2017	\$4,000
10019	West Sunnybrook Rd (82 nd Ave to Harmony Rd)	Construct 3-lane extension	Clackamas Co.	2008-2017	\$6,970
10869	Sunrise Project (JTA Portion)	Improvements consistent with Supplemental EIS (2-lane mainline from I-205 to 122 nd)	ODOT	2008-2017	\$150,000

2035 Baseline Traffic Volumes

As can be seen in Figure 8-2a, traffic volumes at the study locations are projected to increase by approximately 10% to 70% during the p.m. peak hour, with most locations generally projected to have approximately 10% to 25% growth. This corresponds to increases of approximately 140 vehicles during the p.m. peak hour on King Rd and 230 to 570 vehicles on Linwood Ave. The traffic volumes on McLoughlin Blvd are projected to increase by over 500 vehicles north of Hwy 224, and by 230 vehicles south of River Rd. On Hwy 224, about 500 more vehicles are expected in the p.m. peak hour east of McLoughlin Blvd, and 430 vehicles are expected west of the interchange with Lake Rd. The largest projected traffic increase is on Harmony Rd east of Linwood Ave (to over 1,000 vehicles), which is related to future transportation projects that will change capacity and circulation in the area such as the Harmony Rd extension to Sunnybrook Rd and the construction of the Jobs & Transportation Act (JTA) portion of the Sunrise Corridor. The forecasted increase in volume means that many of the study intersections will fail to meet the performance standards of the City of Milwaukie or the Oregon Department of Transportation (ODOT) in 2035.



LEGEND

- 00%** - Percentage Increase 2012 - 2035
- 00** - Volume Difference 2012 - 2035

DKS



No Scale

Figure 8-2A

PERCENT INCREASE IN PM PEAK HOUR VOLUMES

2035 Baseline Corridor Operations

Assessing traffic volumes alone does not consider the ability for transportation facilities to handle traffic demand. A volume-to-capacity (V/C) plot provides a comparison between traffic demand and available capacity. These plots are generally used as a high-level measure to provide an overall quality of the transportation system, since the plots do not consider the full spectrum of operational details (such as traffic control, signal timing, etc) that affect transportation facility performance. Rather, such plots provide a general assessment that can identify corridors or segments that may have insufficient capacity or require additional analysis.

Figure 8-2b shows the 2035 p.m. peak period V/C for major corridors in the study area. Many streets in Milwaukie would continue to have a V/C ratio below 0.85, indicating generally uncongested conditions during the peak hour. Two primary corridors, Linwood Ave and Hwy 224, would be approaching capacity, with V/C ratios nearing 1.0. Both Hwy 99E and 17th Ave would be over capacity (V/C > 1.0). These corridors would be unable to fully accommodate traffic demand during the p.m. peak hour. The excess traffic demand would extend the duration of congestion at these locations or would divert to other routes that have additional capacity.

2035 Baseline System Measures

Travel Time Reliability

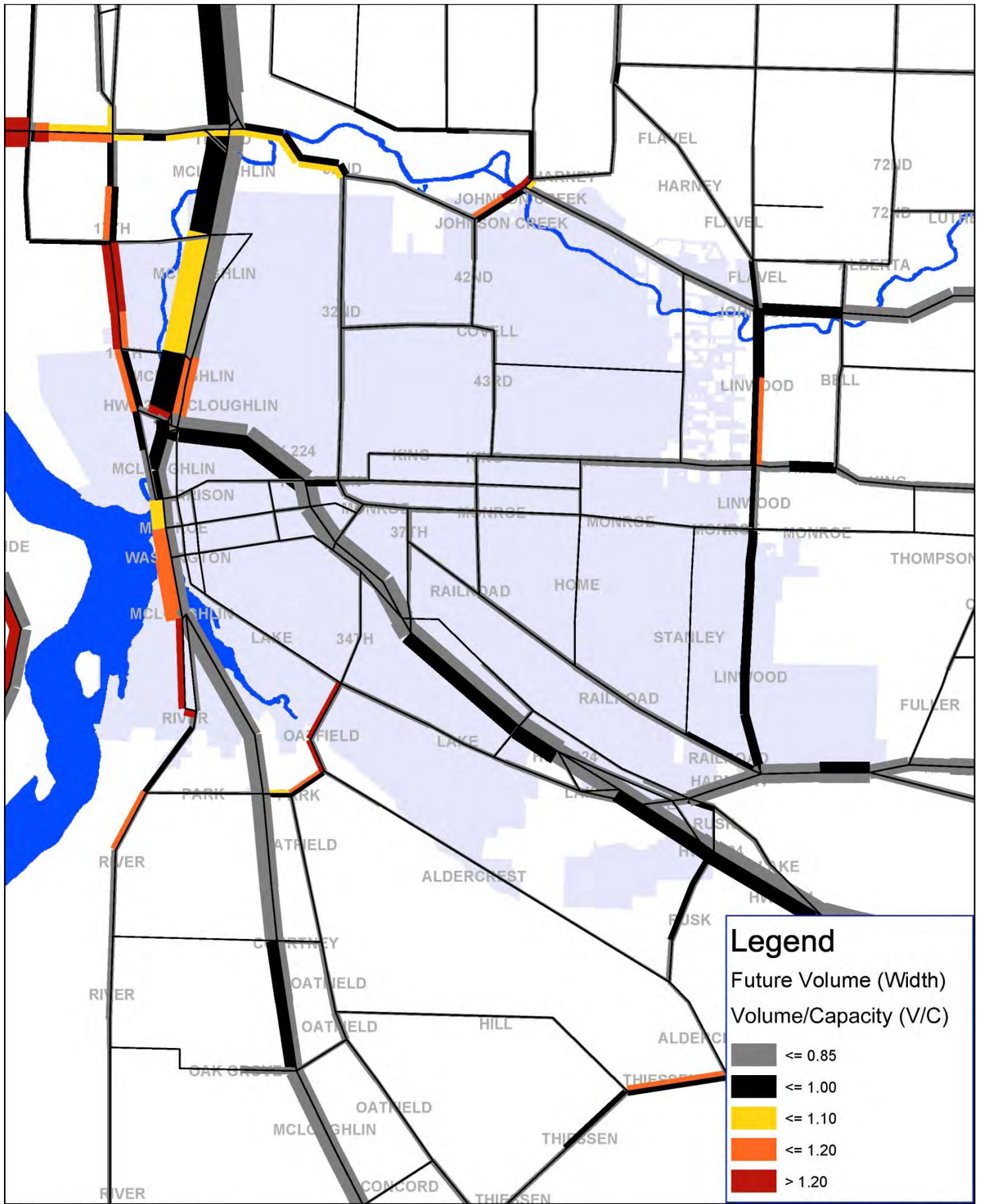
Travel time reliability on Hwy 99E (McLoughlin Blvd) and Hwy 224 was assessed using the travel demand model and creating daily (for each hour) traffic profiles using the Hours of Congestion tool developed by DKS Associates working in conjunction with ODOT. The daily traffic profiles were used to estimate the travel time along the corridor by time of day to create daily corridor speed profiles. In addition, a summary metric of buffer index (BI) was produced to quantify the travel time variability throughout the day. In general, a higher BI score indicates more variability (less reliability) in travel times.

Table 8-3 Summary of Travel Time Reliability Measures by Corridor

Corridor	Direction	Year 2010		Year 2035		Change (2035-2010)	
		Ave Speed (mph)	Buffer Index*	Ave Speed (mph)	Buffer Index*	Ave Speed (mph)	Buffer Index ³
Hwy 99E	Northbound	28	2.5	22	2.6	-6	+0.1
	Southbound	30	1.9	23	2.2	-7	+0.3
Hwy 224	Eastbound	40	0.6	30	2.3	-10	+1.7
	Westbound	42	0.2	36	1.0	-6	+0.8

Based on an assessment of the average daily travel time, each corridor would drop approximately 5-10 miles per hour. The largest drop in speed is projected to occur along Hwy 224 in the eastbound direction (10 miles per hour speed reduction), which also has the largest increase in buffer index, indicating that future travel times will be much less reliable than current conditions.

³ A buffer index (BI) score of 0.0 is free-flow, with larger numbers indicating increased speed variability. Generally, a buffer index between 1.0 and 2.0 represents corridors with significant peak period congestion and values above 2.0 represent severe congestion that spreads into multiple hours. Corridors with a buffer index greater than 2.0 are shown highlighted in bold font.



Milwaukee TSP
 Note: Raw Travel Demand Model Plot

FIGURE 8-2B
 2035 PM Peak Hour Volume/Capacity for Major Roads

Vehicle Miles Traveled per Capita (VMT/capita)

Another system measure of effectiveness is vehicle miles traveled (VMT), which is the total vehicle miles of travel associated with the study-area trips (vehicle trips beginning and/or ending in the study area) on roadways within the Metro region boundary. The VMT per person living in the study area is estimated by traffic volumes from the travel demand model and the 2035 population estimates provided by Metro.

A system planning-level evaluation of the transportation conditions in the existing year and the "low build" alternative scenario was conducted using the travel demand model. This analysis considered the magnitude of system impacts, rather than the site-specific benefit that a particular improvement project could provide to the localized area. The VMT/capita for the base year (2010) was 3.44; under the "low build" scenario, the VMT/capita for 2035 is 2.99, a 13% drop from the base year.

2035 Baseline Intersection Capacity Analysis

This section presents the results of the capacity analysis to determine the potential intersection improvements that would be necessary as part of a long-range master plan. The improvements outlined in the following section are a guide to be used in defining the specific types of rights-of-way and street improvements that will be needed as traffic growth and infill development occurs.

Table 8-4 summarizes the results of the needs analysis to forecast how the TSP study intersections will perform, given the 2035 base case scenario. Based on the analysis, approximately half (14 of 24) of the study intersections would meet acceptable jurisdictional operating standards in 2035; however, 10 of the 24 intersections would not meet standard. The locations that would not meet standard are generally located along the major regional facilities, Hwy 99E and Hwy 224. The Minimum Acceptable Measures of Effectiveness for intersections during the peak hour are as follows:

- City of Milwaukie = Level of Service D
- Metro/ODOT = 0.99/0.99 (1.10/0.99 in designated Town Centers & Specific Corridors)

Table 8-4 2035 Base Case Intersection Level of Service (P.M. Peak Hour)

Intersection	Existing 2012			Future 2035 Base Case		
	Level of Service (LOS)	Average Delay (Seconds)	Volume/Capacity (V/C)	Level of Service (LOS)	Average Delay (Seconds)	Volume/Capacity (V/C)
Two-Way Stop Controlled Intersections						
McLoughlin Blvd @ 22 nd Ave	A/D	26.4	0.01	A/E	38.7	0.01
Harrison St @ 21 st Ave	A/C	18.0	0.10	A/C	17.1	0.25
King Rd @ 42 nd Ave	A/B	14.3	0.26	A/C	18.6	0.44
Monroe St @ Linwood Ave	A/D	31.2	0.51	A/F	>50	>1.0
All-Way Stop Controlled Intersections						
Harrison St @ Main St	B	13.2	0.39	C	17.0	0.71
42 nd Ave @ Harrison St	B	12.8	0.22	C	23.7	0.86
Johnson Creek Blvd @ 32 nd Ave	F	>50.0	0.77	F	>50.0	1.45
Signalized Intersections						
McLoughlin Blvd @ Ochoco St	B	10.1	0.85	C	26.8	1.04
McLoughlin Blvd @ Milport Rd	A	4.4	0.78	A	7.9	0.91
McLoughlin Blvd @ Harrison St	D	47.1	0.99	E	79.0	1.18
McLoughlin Blvd @ Washington St	C	20.0	0.88	E	68.4	1.14
Hwy 224 @ 17 th Ave	C	20.7	0.59	C	23.2	0.74
Hwy 224 @ Harrison St	D	40.0	0.89	E	74.7	1.13
Hwy 224 @ Monroe St	B	19.0	0.75	C	27.1	0.87
Hwy 224 @ Oak St	D	44.1	0.88	E	58.3	1.01
Harrison St @ 32 nd Ave	B	10.5	0.45	B	18.6	0.70
McLoughlin Blvd @ River Rd	D	35.5	0.99	F	>80.0	1.14
Lake Rd @ Oatfield Rd	D	36.0	0.62	D	42.2	0.81
Hwy 224 @ 37 th Ave	C	25.5	0.82	F	>80.0	1.26
Hwy 224 @ Freeman Way	C	30.5	0.94	D	52.7	1.06
Hwy 224 @ Lake Rd	B	16.1	0.68	D	35.3	0.89
Johnson Creek Blvd @ Linwood Ave	D	53.6	0.97	F	>80.0	1.55
Linwood Ave @ King Rd	D	47.5	0.83	E	61.1	0.94
Linwood Ave @ Harmony Rd	E	64.5	0.94	F	>80.0	1.55

Notes: A/A=major street LOS/minor street LOS.
 Signalized and all-way stop delay = average vehicle delay in seconds for entire intersection.
 Unsignalized delay = highest minor street approach delay.
 Intersections shown in **bold type** exceed jurisdictional standards.
 Intersections and corresponding LOS or V/C are illustrated in Figure 8-3

Milwaukie's needs, in terms of capacity improvements, are generally greater on regionally significant routes such as Hwy 99E (McLoughlin Blvd) and Hwy 224 due to the role these routes play in carrying people to destinations throughout the region while passing through the city.

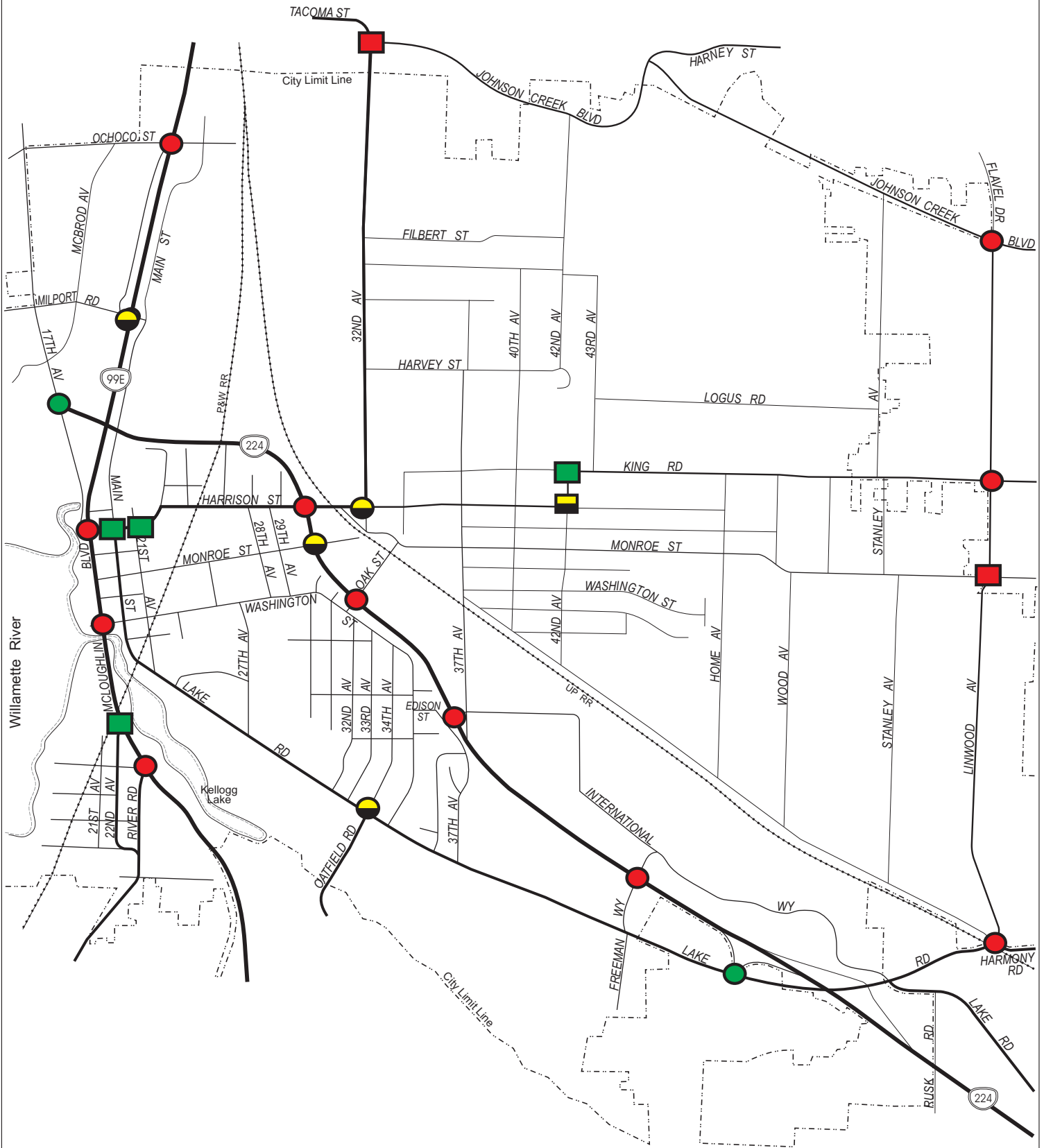
Two of the study intersections currently do not meet the City's Minimum Acceptable Measure of Effectiveness of LOS D: (1) Johnson Creek Blvd at 32nd Ave, and (2) Linwood Ave at Harmony Rd.

- **Johnson Creek Blvd at 32nd Ave:** As part of the PMLR project, a traffic signal and westbound left-turn lane are planned to be constructed for this intersection by TriMet. Table 8-4 considers the intersection as-is and so represents the projected LOS if the planned improvements are NOT made.
- **Linwood Ave at Harmony Rd:** This intersection is within the jurisdiction of Clackamas County and is being addressed as part of the County's current TSP update project. Milwaukie City Council has indicated willingness to consider the current LOS E to be acceptable, given neighborhood concerns about the traffic implications of a major improvement to the intersection.

Figure 8-3 depicts the study area intersections with good, adequate, or poor operational performance during the p.m. peak hour in the year 2035. As can be seen in this figure, approximately half (10 of 24) of the study intersections will operate under poor conditions in 2035. The high growth in volumes along regional facilities such as McLoughlin Blvd and Hwy 224 will not only bring those facilities close to capacity but will also create significant delay on side streets. The future operational analysis for each intersection is outlined in the following sections.

The introduction of the light rail line may affect operational performance at key intersections downtown. As a result, a future update to the TSP may need to include new intersections on the study list (e.g., Washington St and Main St, Washington St and 21st Ave).

Table 8-5 summarizes the existing and future needs that have been identified and lists potential strategies to address each need.



LEGEND

- - Good Operations (LOS A, B, or C, & V/C < 0.84)
- - Acceptable Operations (LOS D & 0.84 < V/C < 0.95)
- - Poor to Failed Operations (LOS E or F & V/C > 0.95)
- Unsignalized Intersection
- Signalized Intersection

*Note: Table 8-2 contains the LOS and V/C for each intersection.



NO SCALE

Figure 8-3

**2035 FUTURE NO-BUILD OPERATIONS
 STUDY AREA INTERSECTIONS**

Table 8-5 Summary of Motor Vehicle System Gaps and Needs

Reference ID	Location	Need	Potential Strategies to Address Need				
			Intersection Control	Lane Channelization	Alternative Route Improvements	Transportation System Management & Operations (TSMO)	Corridor Extension/Widening
Existing Intersection Needs							
N1	Johnson Creek Blvd @ 32 nd Ave	Intersection capacity	X	X	X	X	
N2	Linwood Ave @ Harmony Rd	Intersection capacity		X	X	X	
N3	Hwy 224 @ Lake Rd	Safety improvements	X	X			
Future Intersection Needs							
N4	Monroe St @ Linwood Ave	Intersection capacity	X	X	X	X	
N5	Hwy 224 @ Harrison St	Intersection capacity		X	X	X	
N6	McLoughlin Blvd (Hwy 99E) @ Harrison St	Intersection capacity		X	X	X	
N7	McLoughlin Blvd (Hwy 99E) @ Washington St	Intersection capacity		X	X	X	
N8	McLoughlin Blvd (Hwy 99E) @ River Rd	Intersection capacity		X	X	X	
N9	Hwy 224 @ 37 th Ave	Intersection capacity		X	X	X	
N10	Hwy 224 @ Freeman Way	Intersection capacity		X	X	X	
N11	Johnson Creek Blvd @ Linwood Ave	Intersection capacity		X	X	X	
N12	Linwood Ave @ King Rd	Intersection capacity		X	X	X	
Future Corridor Needs							
N13	Johnson Creek Blvd	Corridor capacity			X	X	X
N14	Linwood Ave	Corridor capacity			X	X	X
N15	McLoughlin Blvd (Hwy 99E)	Corridor capacity			X	X	X
N16	Oatfield Rd	Corridor capacity			X	X	X
Arterial/Collector Grid System Gaps							
N17	Johnson Creek Blvd (near 42 nd Avenue) to Lake Rd (near Oatfield Rd)	North-south arterial connection					X
N18	McLoughlin Blvd (Hwy 99E) to Linwood Ave (between Johnson Creek Blvd and Harrison St/King Rd)	East-west collector connection					X
N19	Railroad Ave (near Home Ave) to Aldercrest Rd (near Kellogg Rd)	North-south collector connection					X

STRATEGIES

The future street system needs in Milwaukie cannot be met through a single "fix-all" cure. Instead, a set of interrelated strategies need to be implemented to meet performance standards, serve future growth and conform to the city's future needs. Strategies for managing the forecasted future travel demand are multifaceted.

The impact of future growth to Milwaukie would be severe without investment in both capital improvements and operating improvements. Strategies for meeting automobile facility needs include Transportation System Management and Operations (TSMO), Transportation Demand Management (TDM), and adding capacity to roads and intersections.

The following sections outline the types of improvements that could be used to manage the system given future growth. Phasing of implementation is necessary, since funding and staging constraints limit the City's ability to implement all improvements at once. This requires prioritization of projects and periodic updating to reflect current needs. Most importantly, it should be understood that as regional growth outpaces local growth, the improvements outlined in the following sections are a guide to managing the increased traffic volume in the city as it occurs over the next 22 years.

Transportation System Management and Operations (TSMO)

Transportation System Management and Operations (TSMO) focuses on low cost strategies within the existing transportation infrastructure to enhance operational performance. The strength of a TSMO approach is it focuses on maximizing urban mobility while treating all modes of travel as a coordinated system. TSMO strategies include signal improvements, traffic signal coordination, traffic calming, access management, local street connectivity, and intelligent transportation systems (ITS). Traffic signal coordination and ITS projects typically provide the most significant tangible benefits to the traveling public. The primary focus of TSMO measures are improvements that result in regional-scale benefits. However, there are a number of TSMO measures that could be used in a smaller scale environment such as Milwaukie.

Intelligent Transportation Systems (ITS)

ITS involves the application of advanced technologies and management techniques to relieve congestion, enhance safety, provide services to travelers, and assist transportation system operators in implementing suitable traffic management strategies. An ITS program focuses on increasing the efficiency of existing transportation infrastructure, enhancing the performance of the overall system and reducing the need to add capacity (e.g. travel lanes). Efficiency is achieved by providing services and information to travelers so they can make better travel decisions, and also to transportation system operators so they can better manage the system and improve system reliability.

Clackamas County has prepared an ITS plan for the urbanized area of Clackamas County. The Clackamas County ITS Plan⁴ has identified arterial signal control ITS projects on major streets throughout the county. Within the TSP study area, McLoughlin Blvd, Hwy 224, Johnson Creek Blvd, King Rd, and Harmony Rd have been identified for planned fiber optic cable, transit priority corridor status, and closed-circuit cameras at several major intersections.

Other ITS projects to consider within Milwaukie may include:

- Transit signal priority
- Signal coordination and optimization

⁴ Clackamas County ITS Plan, DKS Associates, Inc. and Zenn Associates, February 2003.

- Traffic monitoring and surveillance
- Information availability
- Incident management

To support future ITS projects, including traffic signal operations, the City of Milwaukie and Clackamas County could require that roadway improvement projects include the installation of three-inch conduit along arterial and selected collector roadways to serve new ITS equipment in the corridor. A three-inch conduit would ensure adequate wiring capacity to accommodate future ITS projects.

Neighborhood Traffic Management

There are some Neighborhood Traffic Management elements, such as speed humps, in place in Milwaukie. The City should continue this effort with additional traffic-calming measures (where applicable) and work with the community to find the traffic-calming solution that best meets their needs and maintains roadway function. Neighborhood Traffic Management techniques are covered in more detail in Chapter 11.

Access Management

Access Management is a policy tool that seeks to balance mobility (efficient, safe, and timely travel) with property access. Proper implementation of access management techniques should result in reduced congestion, accident rates, roadway widening, air pollution, and energy consumption.

The presence of numerous driveways can erode the capacity of arterial and collector roadways. Access management is the practice of limiting the number and spacing of driveways and intersections on arterial and collector facilities to maintain the capacity of the facilities and preserve their functional integrity. Preservation of capacity is particularly important for maintaining the traffic flow on higher volume roadways such as Linwood Ave and King Rd. The city needs a balance of streets that provide access with streets that serve mobility.

Several access management strategies have been identified to improve local access and mobility in Milwaukie:

- Develop specific access management plans for regional routes, arterial and collector streets in Milwaukie to maximize the capacity of the existing facilities and protect their functional integrity.
- Work with land use development applications to consolidate driveways where feasible.
- Provide left-turn lanes where warranted for access onto cross streets.
- Construct raised medians to limit driveway access to right-in/right-out turning movements, as appropriate.

New development and roadway projects on city streets should meet the City's adopted access spacing standards, which are summarized in Table 8-6.

Table 8-6 Access Spacing Standards for City Street Facilities

Access Treatment	Functional Classification	Intersection				Desirable Signal Spacing ⁵	Median Control
		Public Road		Private Drive			
		Type	Spacing	Type	Spacing		
Full control (freeway)	Arterials	Interchange	2-3 mi	None	N/A	None	Full
Partial control	Arterials	At grade	530-1000 ft	Lt/Rt Turns	300 ft	1000 ft	Partial/None
Partial control	Collectors	At grade	300-600 ft	Lt/Rt Turns	150 ft	1,000 ft	None

Many existing roadways and driveways do not meet these standards because they were installed when traffic volumes were substantially lower and before the City established access spacing criteria. As traffic volumes increase, controlling access on arterial and collector roadways will be important to maintaining a safe and functioning street network.

Access Management for State Facilities

The Oregon Highway Plan (OHP) defines access spacing standards on State facilities for roadways such as McLoughlin Blvd and Hwy 224. These standards are shown in Table 8-7. Preserving capacity on State facilities is especially important, since substandard performance due to a lack of capacity could force drivers to look for alternative routes along city streets.

Table 8-7 Access Spacing Standards for ODOT Facilities

Facility	Location	Highway Classification	National Highway System	Truck Route	Freight Route	Access Spacing Standard (ft)
McLoughlin Blvd (Hwy 99E)	North city limits to Hwy 224	Statewide	Yes	Yes	Yes	990
	Hwy 224 to Scott St	District	No	Yes	No	500
	Scott St to River Rd	District (Special Transportation Area)*	No	Yes	No	175*
	River Rd to South city limits	District	No	Yes	No	500
Hwy 224	17 th Ave to McLoughlin Blvd	District	No	No	Yes	500
	McLoughlin Blvd to East city limits	Statewide (Expressway)	Yes	Yes	Yes	2640

*Minimum access management spacing for public road approaches is the existing city block spacing or the city block spacing as identified in the local comprehensive plan. Public road connections are preferred over private driveways, and in Special Transportation Areas, driveways are discouraged. However, where driveways are allowed and where land use patterns permit, the minimum access management spacing for driveways is 175 feet (55 meters) or midblock if the current city block is less than 350 feet (110 meters).⁶

⁵ Generally, signals should be spaced to minimize delay and disruptions to through traffic. Signals may be spaced at intervals closer than those shown to optimize capacity and safety.

⁶ Oregon Department of Transportation (ODOT), 1999 Oregon Highway Plan (OHP).

Traffic Signal Spacing

Traffic signals that are spaced too closely on a corridor can result in poor operating conditions and safety issues due to the lack of adequate storage for queuing vehicles. Milwaukie is built-out, and as a result there will not likely be many new roads constructed within the city. However, as traffic volumes increase as a result of in-fill development and regional growth, new signals on the existing street system may be necessary to manage traffic flow. When this is the case, the City will evaluate traffic signal warrants to determine if a traffic signal is an appropriate solution. Traffic signals should only be implemented when deemed necessary by the City Engineering Director to enhance safety and promote mobility. P.M. peak-hour signal warrants have already been met for the intersections at Johnson Creek Blvd/32nd Ave and Harrison St/42nd Ave. Future year 2035 traffic volume projections at the intersection of Linwood Ave/Monroe St would trigger peak-hour signal warrants.

Local Street Connectivity

The local street network in Milwaukie is nearly built out and is not well connected in many neighborhoods. Access opportunities for entering or exiting neighborhoods are limited. There are many long blocks or cul-de-sacs outside of the downtown area that force out-of-direction travel when traveling between and within neighborhoods. Additionally, Milwaukie has many barriers that limit connectivity such as McLoughlin Blvd, Hwy 224, and the Union Pacific Railroad (UPRR) tracks. The combination of these barriers and the lack of connectivity cause many intracity trips to travel along the few through streets that do connect across these barriers.

Increasing connectivity between neighborhoods has many benefits, including: reducing out-of-direction travel and VMT, enhancing accessibility between various travel modes, balancing traffic levels between streets, and reducing public safety response time.

Topography and environmental conditions limit the potential for connectivity in several areas of Milwaukie. However, in several areas there is potential to connect streets over time. Figure 8-4 shows the Proposed Street Connectivity Plan for Milwaukie. Some of the localized congestion on roads such as Linwood Ave, King Rd, 32nd Ave, or Monroe St could be improved through enhanced street connectivity. Several short roadway connections are needed to connect disjointed local streets and reduce out-of-direction travel for vehicles, pedestrians, and bicyclists. In limited cases, a short length of new road would be necessary for improved connectivity.

The arrows on Figure 8-4 represent potential connections and the general direction for the placement of the connection. In each case, the specific alignments and design will be determined upon development review. If a connection is made that increases neighborhood connectivity, such a change could trigger reclassification of a street from a "local" to a "neighborhood route." When the opportunity arises during land development, the City requires new local connections that will result in a grid of vehicle access every 530 feet and bicycle/pedestrian access every 300 feet.⁷

The arrows shown on Figure 8-4 indicate priority local and neighborhood connections only. Local connections for existing stub end streets, cul-de-sacs, or extended cul-de-sacs in the road network are, for the most part, not identified on this figure. Pedestrian connections from any cul-de-sac should be considered mandatory as future development and redevelopment occur. The goal is improved connectivity for all modes of transportation.

There are several large parcels (5 acres or greater) in Milwaukie that are either undeveloped or that are developed but have land value that exceeds the building value based on an

⁷ This standard meets the Metro RTP access spacing requirements for new residential or mixed use developments.



Transportation System Plan

FIGURE 8-4

PROPOSED STREET CONNECTIVITY PLAN

November 2013

LEGEND

Functional Classification

- Arterial
- Collector
- Neighborhood Route
- Local

Street Connectivity

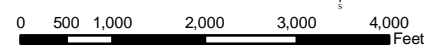
- Lots greater than 5 acres
- ↔ Proposed Street Extension
- ↔ Potential Future Street Extension (Tacoma Station Area Plan)

Other Map Features

- Schools
- Light Rail Station
- Light Rail Transit
- ⋯ Kellogg Creek Trail
- ⋯ Springwater Trail
- ⋯ Trolley Trail
- Major Roads
- Railroad
- - - County Line
- Water
- Parks
- City Limits



DKS Associates
TRANSPORTATION SOLUTIONS



assessment of available GIS data. Figure 8-4 shows the locations of these parcels. Each of these sites already has frontage on a public street, but only 1 or 2 of the parcels are located where a future street connection would be useful and practical. Figure 8-4 shows where future street connections are desired near these sites. The City's Public Works Standards and the standards for public facility improvements found in the City's Zoning Ordinance will ensure that adequate street connections are established as needed at the time of development or redevelopment of any of these particular sites.

Arterial and Collector Street Connectivity

According to the principles established in Metro's 2035 RTP, arterial streets should be spaced no farther than 1 mile apart and collector streets should be accessible within 1/2 mile of any point in Milwaukie.⁸ Given the pattern of existing development in Milwaukie and the various constraints that have influenced it to date, there are not many opportunities to improve the existing network of arterial and collector streets.

The following is an assessment of the gaps identified using the Metro 2035 RTP standards:

- **Gap 1** (arterial gap on Johnson Creek Blvd between 32nd Ave and 45th Ave): The 2007 TSP update downgraded the classification of Johnson Creek Blvd between 40th Ave and Brookside (the section within Milwaukie city limits) from arterial to collector to better coordinate with the street's neighborhood collector designation in the City of Portland and to reflect the low-density residential land surrounding the corridor.
- **Gap 2** (arterial gap on 42nd Ave between Johnson Creek Blvd and King Rd): From Johnson Creek Blvd, 42nd Ave does not connect directly to King Rd; instead, the connection is made by either going 1 block east on Howe St to 43rd Ave or 2 blocks west on Harvey St to 40th Ave. Extending 42nd Ave as an arterial would require significant property acquisition in an established low-density residential neighborhood. There are also 3 historic properties along 42nd Ave between Johnson Creek Blvd and King Rd.
- **Gap 3** (arterial gap on 42nd Ave between Harrison St and Railroad Ave): The existing route is a collector street that goes through an established low-density residential neighborhood.
- **Gap 4** (arterial gap between Railroad Ave and Lake Rd): Establishing an arterial connection would involve crossing an active rail line and going through an existing industrial park. A new connection would require improvement of a very problematic intersection (International Way, 37th Ave, and Hwy 224) as well as crossing Hwy 224 and going into an established residential neighborhood at a different angle than the existing grid alignment there.
- **Gap 5** (collector gap along Kelvin/Howe/Willow St between Hwy 99E and Linwood Ave): Establishing a collector connection would involve bisecting the city's primary manufacturing/industrial area and crossing two active freight rail lines and the new light rail. The existing residential streets are not well aligned to allow easy crossing of other intersecting collectors. The eastern end of the connection would be through an unimproved roadway with a steep slope adjacent to a large wetland property on the north.
- **Gap 6** (collector gap at Home Ave between Railroad Ave and Lake Rd): The connection south from Home Ave would have to cross an active rail line and a protected water quality resource, then cross Hwy 224. A connection between Hwy 224 and Lake Rd would be at an angle to the existing alignment in an established low-density residential neighborhood.

⁸ Regional Transportation Functional Plan, Title 1, 3.08.110.C.

- **Gap 7** (collector gap at Vernie/Maplewood from Lake Rd to Aldercrest Dr): A collector connection would be very close to protected wetlands, go through an existing low-density residential neighborhood, and have to cross Kellogg Creek to get to Aldercrest Dr (in Clackamas County's jurisdiction).

This assessment of gaps does not represent a proposal to establish arterials or collectors in the identified areas. Rather, it is presented to show existing conditions in Milwaukie with respect to specific connectivity standards in Metro's 2035 RTP.

Transportation Demand Management

Transportation Demand Management (TDM) is a general term used to describe any action that removes single-occupant vehicle trips from the roadway network during peak travel demand periods. As growth occurs, the number of vehicle trips and travel demand in the area will also increase. The ability to change a user's travel behavior and provide alternative mode choices will help to minimize the potential growth in trips.

Generally, TDM focuses on promoting alternative modes of travel for large employers as a way to reduce the VMT. This is due in part to the Employee Commute Options (ECO) rules that were passed by the Oregon Legislature in 1993 to help protect the health of Portland area residents from air pollution and to ensure that the area complied with the Federal Clean Air Act.⁹

Currently, Metro supports an online tool, "Drive less. *Connect*," (through the Regional Travel Options program) that promotes a ride-matching service connecting carpoolers and bike buddies. Since its launch in 2011, commuters avoided using approximately 50,000 gallons of gasoline and saved roughly \$308,000 collectively by joining carpools, biking, and riding transit.

Research has shown that a comprehensive set of complementary policies implemented over a large geographic area can have a measured effect on the VMT to/from that area.¹⁰ However, the same research indicates that for TDM measures to be effective, they should go beyond the low-cost, noncontroversial measures commonly used such as carpooling, establishing transportation coordinators or associations, and designation of priority parking spaces.

The more effective TDM measures include parking and congestion pricing, improved services for alternative modes of travel, and other market-based measures. However, TDM includes a wide variety of actions that are specifically tailored to the individual needs of an area. In general, TDM elements and programs have a potential trip reduction ranging between 1% and 10%. To help implement TDM measures in the future, the City should consider setting TDM goals and policies for new development.

With an increase in the number of projected regional trips through the city, regional TDM measures should help to reduce congestion and be a benefit to the City of Milwaukie and the region. The RTP includes TDM projects for the Milwaukie area in the 2035 financially constrained plan. These measures are identified in Table 8-8.

⁹ Oregon Administrative Rules, Chapter 340, Division 30.

¹⁰ *The Potential for Land Use Demand Management Policies to Reduce Automobile Trips*, ODOT, by ECO Northwest, June 1992.

Table 8-8 TDM Improvements included in the RTP Financially Constrained System

Metro Project ID	Location	Improvement	Jurisdiction	Timeline	Cost (\$1,000s)
10020	Countywide	Advanced transportation system management and ITS program	Clackamas County	2008-2017	\$6,514
10901	Regionwide	Milwaukie Light Rail Extension	TriMet	2008-2017	\$1,148,000
10159	Regionwide	Springwater Trail Access Improvements	Portland	2008-2017	\$3,032
11331	Regionwide	Frequent Service Bus Capital Improvements (Phase 1)	TriMet	2008-2017	\$16,000
11230	Regionwide	Frequent Service Bus Capital Improvements (Phase 2)	TriMet	2008-2017	\$15,000
11332	Regionwide	I-205 BRT	TriMet	2008-2035	\$30,000
10990	Regionwide	Park-and-Ride Management Strategy Implementation	TriMet	2008-2035	\$1,000
10988	Regionwide	Incremental Increases in Park-and-Ride Lots and Capacities	TriMet	2008-2017	\$20,000
11333	Regionwide	Bus Stop Improvements	TriMet/SMART	2008-2035	\$14,000
11042	Regionwide	Bus Priority Treatments	TriMet	2008-2035	\$5,029
11043	Regionwide	Priority Pedestrian Access to Transit Improvements	TriMet	2008-2035	\$5,000

The Metro regional travel model includes assumptions about which modes of transportation people choose to use. Targets for trips using non-single-occupant-vehicle (non-SOV) modes have been set for some 2040 Plan areas. For Milwaukie, the model forecast assumes completion of the projects included in the RTP financially constrained scenario, with a non SOV Modal Target of 45% to 55% in the designated Town Center area and 40% to 45% in Industrial/Employment areas. All other areas within Milwaukie do not have a non-SOV target.¹¹ Milwaukie will only be able to achieve these targets through a continued effort to implement TDM strategies and promote alternative modes of travel.

Parking Requirements

The City of Milwaukie currently has off-street parking ratios (minimum and maximum) and standards that are consistent with the Transportation Planning Rule (TPR) and RTP parking ratio requirements. Chapter 12 outlines the specific parking strategies for downtown Milwaukie.

Roadway and Intersection Operational and Capacity Improvements

The TSP process identified a number of roadway and intersection capacity improvements. This section summarizes the evaluation of intersection of the three types of capacity and connectivity improvements:

- City Street and Intersection Improvements
- McLoughlin Blvd (Hwy 99E) Alternatives
- Hwy 224 Alternatives
- Hwy 224/99E Refinement Plan

¹¹ Information related to non-SOV target percentages and designated areas can be found in the Metro Regional Transportation Plan, Table 1.3 page 1-65, and on Figure 3.5 page 3-14.

Conceptual diagrams illustrating the recommended improvements can be found in Appendix D, Conceptual Design Options.

City Street and Intersection Improvements

Most of the study intersections that are on city streets will require improvements to meet City standards under forecasted 2035 conditions. Table 8-9 summarizes the improvements needed for these study intersections to meet City standards; more detailed descriptions of the improvements follow.

Table 8-9 Improvements Needed for City Intersections to Meet City Standards

Intersection	Improvement	Before	After
Linwood Ave @ Monroe St	Signalization	A/F	B
Johnson Creek Blvd @ 32 nd Ave*	Signalization with westbound left-turn lane	F	D
Johnson Creek Blvd @ Linwood Ave	Add eastbound (EB) right-turn lane Add westbound (WB) right-turn lane Add northbound (NB) right-turn lane	F	D
Linwood Ave @ King Rd	Protected/permissive left-turn phasing northbound (NB) and southbound (SB)	E	D

*This intersection is in the City of Portland. As such, improvements will be determined by the City of Portland. Project is planned by TriMet as part of the PMLR project.

- Linwood Ave/Monroe St:** This location would meet traffic signal warrants for the p.m. peak hour with year 2035 traffic volumes. The addition of the traffic signal would allow Monroe Street traffic to access or cross Linwood Avenue by providing gaps in traffic. The addition of the traffic signal would significantly reduce delay and improve operations on Monroe St (LOS F to LOS B), though additional delay would be added to traffic on Linwood Ave that does not currently stop.
- Johnson Creek Blvd/32nd Ave:** This intersection is in the city of Portland which has an operating standard of LOS D. P.M. peak-hour signal warrants are currently met at this intersection. Installing a traffic signal and a westbound left-turn lane would improve the LOS at this intersection from F to D.¹² This improvement is consistent with TriMet plans as part of the PMLR project. As an alternative improvement, widening the existing bridge north of 32nd Ave would be necessary to provide a southbound left-turn lane at this intersection and realign the intersection so that 32nd Ave would form a T-intersection with Johnson Creek Blvd. While this realignment would be more conducive to serve traffic demands along Johnson Creek Blvd, the primary travel corridor, bridge widening would significantly increase the project cost. A roundabout may be an alternative for this location.

While not studied, the two all-way stop controlled intersections east of 32nd Ave (36th and 42nd Aves) would likely require similar treatment (traffic signal with turn lanes) to meet operational standards. As with the 32nd Ave intersection, the scale of the improvements does not fit well in the residential neighborhood setting. Limiting the project to signals alone would not bring the intersection operations to the desired standard but would relieve traffic congestion.

The City of Portland has jurisdiction of Johnson Creek Blvd from Tacoma St to just west of 40th Ave, the section that includes the 32nd Ave intersection. Portland does not have plans to

¹² Signalization alone would improve the delay from approximately 135 seconds to 110 seconds, and the intersection would still operate at LOS F in the TSP forecast year, 2035. Changes to the intersections in this corridor should be coordinated to ensure that they work together to improve safety and are designed for the posted speed (25 mph).

modify the bridge or the roadway. Clackamas County has jurisdiction north of Brookside Dr and continuing eastward. The County's TSP includes a project to widen the bridge over Johnson Creek.

Milwaukie has jurisdiction over the intersection of Johnson Creek Blvd/42nd Ave, and will coordinate with Portland and Clackamas County if improvements are considered in this corridor. The project listed in the master plan is for signalization only at 42nd Ave. This project is intended to balance the needs of the affected neighborhood and other stakeholders. The number and location of the existing stop signs along Johnson Creek Blvd serve to reduce traffic speeds, which is valued by the adjacent neighborhood. Therefore, before a traffic signal is installed at the intersection of Johnson Creek Blvd and 42nd Ave, the City shall conduct a study that analyzes the advantages of the traffic signal to the adjacent neighborhood and the City's transportation system.

- **Johnson Creek Blvd/Linwood Ave:** Adding eastbound, westbound, and northbound right-turn lanes would improve the operations at this intersection from F to D. No additional improvement would be necessary for the operation of this intersection to meet City standards. Any intersection improvements should protect, if not improve, the Springwater Trail crossing through this intersection.
- **Linwood Ave/King Rd:** Aside from modifying phasing at this intersection or increasing street connectivity throughout the city with parallel routes to Linwood Ave and King Rd, there are no simple solutions to improve operation of this intersection.

McLoughlin Blvd (Hwy 99E) Alternatives

While most intersections along McLoughlin Blvd (Hwy 99E) do not meet future operating standards (V/C of 1.1 within the Town Center), the intersections of McLoughlin Blvd with Ochoco St and Milport St are near capacity but still operate within the ODOT operating standards. Because access is severely restricted from McLoughlin Blvd, the City and ODOT have investigated options for improving freight-related access and circulation for the North Industrial Area. Since both of these intersections are forecasted to meet standards in 2035, improvements focus on access and circulation, not capacity improvements. These potential improvements are outlined in more detail in Chapter 9 Freight Element and Appendix D.

The intersection of McLoughlin Blvd and 17th Ave is primary portal to downtown Milwaukie from McLoughlin Blvd, especially for vehicles traveling to Milwaukie from the north. Improvements to this intersection would be difficult because of the intersection's geometry¹³ and phasing, and the proximity of Johnson Creek Blvd.

The phasing for eastbound and westbound traffic is currently split phase (one side operates independent of the other side). This phasing arrangement increases the amount of time required for vehicles traveling on Harrison St/17th Ave and also decreases the potential time for northbound and southbound vehicle movements.

Shifting traffic away from this intersection and can improve how it functions (its V/C ratio). One way to do this would be to restrict eastbound left turns from 17th Ave onto McLoughlin Blvd. Travelers needing to make this turn could instead be directed through the intersection, to turn left at the next intersection (Harrison St/Main St) and left on Scott St, and right onto northbound McLoughlin Blvd. Forcing this movement would allow for the split phasing at the intersection of Harrison St and McLoughlin Blvd to be removed and improve intersection operations. This

¹³ 17th Ave is perpendicular to McLoughlin Blvd for only a short distance of less than 100 feet. After this distance, the road makes a 90-degree bend to the north and runs parallel to McLoughlin Blvd. This geometry is a result of the close proximity of Johnson Creek and the Willamette River.

option could redirect up to 20 drivers, who normally access McLoughlin Blvd via this intersection, into downtown Milwaukie during the p.m. peak hour.

The interchange of McLoughlin Blvd and Hwy 224 currently connects southbound traffic on McLoughlin Blvd to eastbound on Hwy 224 and westbound traffic on Hwy 224 to northbound on McLoughlin Blvd. It does not provide for a direct connection of the northbound McLoughlin Blvd or eastbound Hwy 224 to southbound McLoughlin Blvd traffic. The construction of a full interchange between McLoughlin Blvd and Hwy 224 would shift vehicles to the interchange and improve operations at the intersection of McLoughlin Blvd and 17th Ave. This interchange, along with the rest of the McLoughlin Blvd/Hwy 224 corridor between Tacoma St and 17th Ave should be studied as part of a Hwy 224/99E Refinement Plan to determine the most cost-effective set of improvement options for the corridor and the City of Milwaukie.

Improvement of the intersection of 17th Ave and Harrison St could involve any number of options, including an increase in the intersection's capacity, improved local connectivity, and parallel routes to decrease demand at the intersection. The City should work with ODOT and Metro to create a solution to maintain operational levels at this intersection while minimizing possible negative impact of any improvements to the intersection. Any improvement recommended by the Hwy 224/99E Refinement Plan should also include improvements to this intersection.

McLoughlin Blvd and River Rd

Without improvements, the intersection of McLoughlin Blvd/River Rd would operate at unacceptable levels during the p.m. peak hour in 2035 (V/C of 1.14 exceeds Town Center target of 1.1). A sketch-level operational analysis conducted for two potential improvement alternatives found that either would improve the intersection to the point of meeting operational mobility standards. The two alternatives are described below.

- **Alternative 1:** One possible improvement would leave the intersection of McLoughlin Blvd and 22nd Ave open in its current configuration. The intersection of McLoughlin Blvd and River Rd would require a second northbound left-turn lane and additional right-of-way to operate within ODOT standards (a V/C ratio of 1.10). This option would improve the operations of the intersection (V/C ratio of 1.06) in a similar manner to the second option (the current geometry requires an exclusive pedestrian phase that limits the intersection operations for motor vehicles).¹⁴ However, this alternative would be less disruptive and is preferred by the Island Station Neighborhood District Association.
- **Alternative 2:** The second alternative would involve consolidating the three intersections into one. Currently, vehicles turning from 22nd Ave onto McLoughlin Blvd are limited to right-in and right-out turns. River Rd has one shared lane to access McLoughlin Blvd, and vehicles access River Rd from McLoughlin Blvd via Bluebird St. The consolidation of the three intersections would greatly decrease the number of access points (and conflict points) to McLoughlin Blvd, and therefore result in safer, more efficient operations. To improve operations to acceptable standards, a second northbound left-turn to access McLoughlin Blvd would be necessary at this new intersection. An eastbound right-turn lane would also be necessary to accommodate the high right-turn volume from the highway, and would result in a V/C ratio of 1.06.

¹⁴ It should be noted that ODOT STIP project titled "OR99E: Kellogg Creek - MP 9.19" (key# 12855) will eliminate the exclusive pedestrian phase and provide signal interconnection between the River Rd intersection and the intersection of McLoughlin Blvd at Washington St. This project is scheduled for construction in 2007.

Hwy 224 Alternatives

Four of the seven study intersections along Hwy 224 are projected to exceed ODOT's V/C ratio requirements (1.1 within the Town Center, 0.99 outside of the Town Center) during 2035 peak-hour operations. Both short-term and long-term solutions are necessary to achieve an acceptable level of mobility on Hwy 224, while allowing for cross-city connectivity.

Short-Term Solutions

Short-term solutions are designed to relieve congestion at multiple intersections. They may not completely alleviate congestion, but can be implemented with relatively low cost at specific locations (versus the generally high cost, large-scale long-term solution). The intersections of Harrison St at Hwy 224 and Oak St at Hwy 224 are the two locations for short-term solutions. The short-term solution is to provide signal-protected left turns. This would require three types of changes: signal phasing, optimizing the signal timing to balance mobility and cross-street connectivity, and some physical modifications at the Harrison St intersection. The physical changes would convert the existing shared through/left-turn lanes at Harrison St into left-turn lanes and restripe the intersection as necessary to align the left-turn lanes. The intersection of Hwy 224/Oak St already has left-turn lanes on Oak St and would not require restriping. ODOT approval would be required for modifications to both intersections. A detailed traffic study would be required to ensure that the new phasing does not detrimentally affect the intersection operations and a signal progression study would be required.

Modifying the intersection of Hwy 224 and 37th Ave may be an additional short-term improvement. The northern leg of the intersection of Hwy 224 and 37th Ave is difficult because 37th Ave currently splits just north of the highway into 37th Ave and International Way. This geometric layout is confusing and increases the potential for possible conflicts. The consolidation of these two approaches into one would improve safety and traffic operations by creating a simpler intersection with one northern approach.

Long-Term Solutions

Long-term solutions for Hwy 224 address mobility along the corridor and cross street connectivity within the city, and require major investments that exceed the forecasted revenue. The alternatives that have been explored in order to meet the Oregon Highway Plan v/c target are outlined below. Alternatives 1-3 have been determined to be infeasible due to the improvement cost and limited forecasted revenue out to 2035. Alternative 4 is the recommended approach for the Hwy 224 corridor for the current planning period, along with establishing alternative mobility targets through a refinement plan.

- **Alternative 1—Seven-Lane:** The Hwy 224 seven-lane cross section alternative would involve increasing the number of through lanes for each direction from two to three, beginning north of Harrison St to south of Lake Rd. This option would require the acquisition of right-of-way, and increase the crossing distance at the intersections. It would solve the future operational deficiencies at the study intersections out to 2035.

While widening Hwy 224 does allow for adequate intersection operations at study area intersections, it would create an even greater barrier to local connectivity. For this reason, some additional alternatives were evaluated to help reduce the potential side street delay and improve the potential east/west connectivity across Hwy 224. In addition, capacity improvements such as widening facilities along the entire corridor are not consistent with Metro's regional prioritization of transportation improvements (which place more focus on intersection or system management improvements).

- **Alternative 2—Modified Split Diamond Interchange:** Construction of a modified split diamond interchange between Harrison St and 37th Ave would involve elevating Hwy 224 from Harrison St to 37th Ave and constructing two tight urban interchanges (which require less right-of-way space than standard freeway interchanges), Monroe St and Oak St would pass under Hwy 224 with a frontage road under Hwy 224 to connect between Harrison St and 37th Ave. To improve connectivity within the city, this option includes the construction of an at-grade rail crossing along Monroe St and the extension of Monroe St to 32nd Ave. This configuration allows for much better intersection operations due to the removal of the Hwy 224 traffic through the intersections. A planning-level operational analysis revealed that the intersections would operate within the State's mobility standards.
- **Alternative 3—Hwy 224 Overpass/Underpass:** Grade separation of the highway would improve the localized intersection operations, but would divert traffic bound for or leaving Hwy 224 to other streets. An overpass over Hwy 224 could be placed at several locations, including Harrison St, Freeman Way and International Way/37th Ave. An option to the overpasses would be to construct Hwy 224 below grade with City streets passing over the highway. This alternative improves intracity connectivity by removing the barrier effect caused by Hwy 224.
- **Alternative 4—Hwy 224 TSMO Improvements:** Improve arterial corridor operations by expanding traveler information and upgrading traffic signal equipment and timings. Install upgraded traffic signal controllers, establish communications to the central traffic signal system, provide arterial detection (including bicycle detection where appropriate), and routinely update signal timings. Provide real-time and forecasted traveler information on arterial roadways including current roadway conditions, congestion information, travel times, incident information, construction work zones, current weather conditions, and other events that may affect traffic conditions. TSMO improvements also include ongoing maintenance and parts replacement (such as monitoring systems; providing power; and replacing cameras, loops, or other data collectors and devices).

Hwy 224/99E Refinement Plan

The City and ODOT should complete a Refinement Plan to determine and recommend alternative mobility targets.¹⁵ The Refinement Plan would provide options for alternative mobility targets, which could include expanding the number of hours beyond the current two-hour measure, establishing a travel-time measure, or other measures. This plan should also consider ways to reduce the highway's barrier effect for all modes through an increased level of connectivity across the facility, consistent with City goals. The Refinement Plan should be completed within one to five years of the adoption of the October 2013 updates to the TSP.

RECOMMENDATIONS

To meet the TSP goals and policies outlined in Chapter 2, the City should take the following steps for improving the street network:

- Manage and improve the entire roadway system consistent with the City's transportation policies and street classifications.

¹⁵ Provisions for alternative mobility targets are allowed per the Regional Functional Plan, Title 1, 3.08.230 and Oregon Highway Plan, Policy 1F3. The Oregon Transportation Commission shall approve the alternative mobility targets in order for them to become effective.

- Work with ODOT and Clackamas County to implement their access control standards on their facilities to reduce conflicts among vehicles and trucks, as well as conflicts between vehicles and pedestrians.
- Identify local street system improvements that are cost-effective in improving State facility conditions. These projects could be candidates for State financial assistance.
- Work with Metro to develop travel forecasts for the City that are used to assess future regional travel needs. The City will participate in verifying housing and employment forecasts to be used when Metro updates the Regional Transportation Plan.
- Coordinate with ODOT regarding implementation of the Oregon Highway Plan for expressways and Special Transportation Areas, including developing alternative mobility targets for Hwy 224 and McLoughlin Blvd.

Master Plan

The Street Network Master Plan is the list of projects needed to mitigate motor vehicle street network deficiencies. Figure 8-5 depicts the approximate locations of the Street Network Master Plan projects, which are also summarized in Table 8-10. This list is a "wish list" of motor vehicle related projects in Milwaukie. Some projects from the master plan were selected for inclusion in the Street Network Action Plan, which consists of projects that the community has identified as its top priorities for allocating and/or pursuing funding. As development occurs, streets are rebuilt, or other opportunities arise, projects on the master plan should be addressed.

The planning-level cost estimates in Table 8-10 are based on general unit costs for transportation improvements, but do not reflect the unique project elements that can significantly add to project costs. For each of these projects, the City will refine the cost estimate to include right-of-way requirements and costs associated with special design details at the time of development.



Transportation System Plan

FIGURE 8-5

STREET NETWORK MASTER PLAN

November 2013

LEGEND

Proposed Street Network Improvements

	Travel Route Improvement		Corridor Refinement Plan
	Roadway Widening Project		Intersection

	Schools		Major Roads
	Kellogg Creek Trail		Streets
	Springwater Trail		Railroad
	Trolley Trail		County Line
	Light Rail Station		Water
	Light Rail Transit		Parks
			City Limits

PROPOSED PROJECTS

- A** Prohibit left turn movement at 17th Ave/McLoughlin Blvd and include in Refinement Plan
- B** Signalize Harrison St/42nd Ave
- C** Conduct Refinement Plan for HWY 99E/HWY 224 focused on motor vehicle and freight mobility.
 - HWY 99E Project Limits: Tacoma St to 17th Ave
 - HWY 224 Project Limits: HWY 99E to Lake Rd Interchange
- D** Reconfigure intersection to consolidate 37th Ave/Industrial Way
- E** Add eastbound/westbound right turn lanes and integrate the trail crossing
- G** Implement protected/permitted phasing for northbound and southbound left turns
- H** Widen Linwood Ave to standard three lane cross section
- I** Widen Railroad Ave to standard three lane cross section
- J** Redesign intersections of River Rd and 22nd Ave to consolidate intersections; or
Add northbound left turn pocket on River Rd
- K** Widen Harrison St to standard three-lane cross section
- L** Add left turn-lanes and protected signal phasing on Harrison St approaches
- M** Widen Lake Rd to standard three-lane cross section
- N** Replace 3-way stop with signal when warranted and appropriate. (Coordinate with the City of Portland)
- O** Enhance connection between King Rd and Harrison St
- P** Add protected signal phasing on Oak St approaches
- Q** Improve intersection/modify access at HWY 224 and Freeman Way
- R** Enhance connection along Stanley Ave at King Rd
- S** Enhance connection along Stanley Ave at Monroe St
- V** Improve safety of Trolley Trail crossing at 22nd Ave
- W** Realign intersection to improve traffic between 42nd Ave and King Rd east of 42nd Ave
- X** Connect local streets within Tacoma Station Area (see Fig 8-4)
- Y** Construct street improvements on Stubb St, Beta St, Ochoco St, Hanna Harvester Dr and Mailwell Dr (TSAP)



DKS Associates
TRANSPORTATION SOLUTIONS

0 500 1,000 2,000 3,000 4,000 Feet

Table 8-10 Street Network Master Plan Projects

Map ID ¹⁶	Priority	Type	Project Name	Project Description	From	To	Cost (\$1,000s) ¹⁷
High Priority Projects							
C	High	C	Hwy 224 & Hwy 99E Refinement Plan	Conduct refinement study to establish alternative mobility targets for Hwy 224 and McLoughlin Blvd for locations not meeting applicable State targets, and explore ways to minimize barrier effect and improve auto and freight mobility.	Hwy 99E Project Limits: Tacoma St to River Rd	Hwy 224 Project Limits: Hwy 99E to Lake Rd Interchange	\$270
D	High	C	Intersection Improvements at Hwy 224 and 37 th Ave	Consolidate the two northern legs of 37 th Ave and International Way into one leg at Hwy 224.	Location-specific	Location-specific	\$2,100
H	High	C	Linwood Ave Capacity Improvements (north)	Widen to standard three lane cross section. Widen bridge over Johnson Creek.	Johnson Creek Blvd	King Rd	\$9,300
H	High	C	Linwood Ave Capacity Improvements (south)	Widen to standard three lane cross section.	King Rd	Harmony Rd	\$12,500
P	High	C	Intersection Improvements at Hwy 224 and Oak St	Add left-turn-lanes and protected signal phasing on Oak St approaches.	Location-specific	Location-specific	\$20
R	High	C	Stanley Ave Connectivity at King Rd	Enhance connection along Stanley Ave at King Rd.	Location-specific	Location-specific	\$60
S	High	C	Stanley Ave Connectivity at Monroe St	Enhance connection along Stanley Ave at Monroe St.	Location-specific	Location-specific	\$60
V	High	C	Intersection Improvements at McLoughlin Blvd and 22 nd Ave	Improve safety of Trolley Trail crossing at 22 nd Ave.	Location-specific	Location-specific	\$200

¹⁶ See Figure 8-4.

¹⁷ Project costs are order-of-magnitude estimates and are in 2012 dollars. Future costs may be more due to inflation. In the case of operational projects, estimated costs are for the entire 22-year planning period.

Map ID ¹⁶	Priority	Type	Project Name	Project Description	From	To	Cost (\$1,000s) ¹⁷
Medium Priority Projects							
A	Med	C	Intersection Improvements at McLoughlin Blvd and 17 th Ave	Prohibit left-turn movement from 17 th Ave to northbound McLoughlin Blvd and include in Hwy 224 & Hwy 99E Refinement Plan.	Location-specific	Location-specific	\$20
E	Med	C	Intersection Improvements at Johnson Creek Blvd and Linwood Ave	Add eastbound right-turn lane and westbound right-turn lane.	Location-specific	Location-specific	\$880
G	Med	C	Intersection Improvements at Linwood Ave and King Rd	Implement protected/permissive left-turn phasing for northbound and southbound approaches.	Location-specific	Location-specific	\$20
J	Med	C	Intersection Improvements at McLoughlin Blvd and River Rd	Consolidate a single access point for the area at Bluebird St with full intersection treatment and signalization or add second northbound left-turn lane at River Rd.	Location-specific	Location-specific	\$980
K	Med	C	Harrison St Capacity Improvements	Widen to standard three lane cross section.	32 nd Ave	42 nd Ave	\$2,800
L	Med	C	Intersection Improvements at Harrison St and Hwy 224	Add left-turn-lanes and protected signal phasing on Harrison St approaches.	Location-specific	Location-specific	\$20
O	Med	C	Harrison St and King Rd Connection	Enhance connection between King Rd and Harrison St	King Rd	Harrison St	\$60
Low Priority Projects							
B	Low	C	Intersection Improvements at 42 nd Ave and Harrison St	Signalize intersection to facilitate dominant traffic flow.	Location-specific	Location-specific	\$280
I	Low	C	Railroad Ave Capacity Improvements	Widen to standard three lane cross section.	37 th Ave	Linwood Ave	\$14,200
M	Low	C	Lake Rd Capacity Improvements	Widen to standard three lane cross section.	21 st Ave	Oatfield Rd	\$8,100
N	Low	C	Johnson Creek Blvd and 42 nd Ave Signalization	Replace 3-way stop with signal when warranted.	Location-specific	Location-specific	\$270

Map ID ¹⁶	Priority	Type	Project Name	Project Description	From	To	Cost (\$1,000s) ¹⁷
Q	Low	C	Hwy 224 Access Modifications at Freeman Way	Modify access at Freeman Way to improve intersection functioning.	Location-specific	Location-specific	\$1,400
W	Low	C	Intersection Improvements at 42 nd Ave and King Rd	Realignment of intersection to improve traffic movements between 42 nd Ave and King Rd east of 42 nd Ave.	Location-specific	Location-specific	\$200
X	Low	C	Local Street Connections in Tacoma Station Area	Connect local streets within Tacoma station area: 24 th Ave between Ochoco St/Moores St & Clatsop St; Omark St between Mailwell Dr & Beta St (w/midblock connection from Main St); and Mailwell Dr to Harrison St via 26 th Ave. (TSAP)	Location-specific	Location-specific	\$8,120
Y	Low	C	Local Street Improvements in Tacoma Station Area	Construct street improvements on Stubb St, Beta St, Ochoco St, Hanna Harvester Dr, and Mailwell Dr. (TSAP)	Location-specific	Location-specific	\$5,280

Notes:

C = Capital Project

O = Operational Project

P = Policy Project

High = High priority

Med = Medium priority

Low = Low priority

TSAP = Tacoma Station Area Plan

Action Plan

The Street Network Action Plan (Table 8-11) identifies the highest priority projects that are reasonably expected to be funded with local funds by 2035, which meets the requirements of the State's Transportation Planning Rule.¹⁸ The action plan project list is based upon a 2007 citywide project ranking process. In 2007, all of the modal master plan projects were ranked by the TSP Advisory Committee after consideration of the Working Groups' priorities, other public support for the project, and how well each project implements the TSP goals and policies. For the 2013 TSP Update, City staff reassessed the prioritization of all projects, incorporating public comments gathered at and around a public meeting in June 2013. Action plan projects that were completed since 2007 were removed from the action plan and new projects identified as top priorities were added.

Table 8-11 Street Network Action Plan

Map ID	Project Name	Project Description	From	To	Project Cost (\$1,000s)	Direct Funding or Grant Match
P	Intersection Improvements at Hwy 224 Crossings (Oak St)	Add left-turn lanes and protected signal phasing on Oak St approaches.	Location-specific	Location-specific	\$20	Match
V	Intersection Improvements at McLoughlin Blvd and 22 nd Ave	Improve safety of Trolley Trail crossing at 22 nd Ave.	Location-specific	Location-specific	\$200	Match
C	Hwy 224 & Hwy 99E Refinement Plan	Conduct refinement study to establish alternative mobility targets for Hwy 224 and McLoughlin Blvd for locations not meeting applicable State targets, and explore ways to minimize barrier effect and improve auto and freight mobility.	Hwy 99E Project Limits: Tacoma St to River Rd	Hwy 224 Project Limits: Hwy 99E to Lake Rd Interchange	\$270	Match

The completion of the action plan project list would improve transportation operations at several locations in Milwaukie. The study intersections would operate as listed in Table 8-12 with the inclusion of action plan projects during the year 2035 p.m. peak hour. Approximately one third of study intersections (8 of 24 locations) would not meet performance standards with the inclusion of the action plan projects. Six of these intersections would be located on ODOT facilities (McLoughlin Blvd or Hwy 224), while the remaining two locations would be on City of Milwaukie facilities (Linwood Ave). Additional refinement plans for McLoughlin Blvd and Hwy 224 are needed to identify appropriate improvements and/or alternate mobility targets for traffic mobility along the corridors.

¹⁸ OAR Chapter 660, Department of Land Conservation and Development, Division 012, Transportation Planning, adopted on March 15, 2005, effective April 2005.

Table 8-12 2035 Action Plan Intersection Level of Service (P.M. Peak Hour)

Intersection	Existing 2012			Future 2035 Action Plan Scenario		
	Level of Service (LOS)	Average Delay (Seconds)	Volume/Capacity (V/C)	Level of Service (LOS)	Average Delay (Seconds)	Volume/Capacity (V/C)
Two-Way Stop Controlled Intersections						
McLoughlin Blvd @ 22 nd Ave	A/D	26.4	0.01	A/E	38.7	0.01
Harrison St @ 21 st Ave	A/C	18.0	0.10	A/C	17.3	0.24
King Rd @ 42 nd Ave	A/B	14.3	0.26	A/C	18.9	0.46
Monroe St @ Linwood Ave	A/D	31.2	0.51	B	11.6	0.66
All-Way Stop Controlled Intersections						
Harrison St @ Main St	B	13.2	0.39	C	19.4	0.78
42 nd Ave @ Harrison St	B	12.8	0.22	C	24.4	0.86
Johnson Creek Blvd @ 32 nd Ave ¹⁹	F	>50.0	0.77	D	46.9	0.93
Signalized Intersections						
McLoughlin Blvd @ Ochoco St	B	10.1	0.85	C	32.8	1.08
McLoughlin Blvd @ Milport Rd	A	4.4	0.78	A	9.5	0.95
McLoughlin Blvd @ Harrison St	D	47.1	0.99	F	83.8	1.20
McLoughlin Blvd @ Washington St	C	20.0	0.88	E	67.3	1.14
Hwy 224 @ 17 th Ave	C	20.7	0.59	C	24.2	0.77
Hwy 224 @ Harrison St	D	40.0	0.89	E	79.6	1.17
Hwy 224 @ Monroe St	B	19.0	0.75	C	31.8	0.97
Hwy 224 @ Oak St	D	44.1	0.88	E	66.9	1.06
Harrison St @ 32 nd Ave	B	10.5	0.45	B	17.3	0.72
McLoughlin Blvd @ River Rd	D	35.5	0.99	F	>80.0	1.14
Lake Rd @ Oatfield Rd	D	36.0	0.62	D	42.7	0.80
Hwy 224 @ 37 th Ave	C	25.5	0.82	F	>80.0	1.30
Hwy 224 @ Freeman Way	C	30.5	0.94	E	58.4	1.08
Hwy 224 @ Lake Rd	B	16.1	0.68	D	39.1	0.91
Johnson Creek Blvd @ Linwood Ave	D	53.6	0.97	F	>80.0	1.23
Linwood Ave @ King Rd	D	42.6	0.79	D	42.0	0.88
Linwood Ave @ Harmony Rd	E	65.0	0.94	F	>80.0	1.55

Notes: A/A=major street LOS/minor street LOS
 Signalized and all-way stop delay = average vehicle delay in seconds for entire intersection
 Unsignalized delay = highest minor street approach delay
 Intersections shown in **bold type** exceed jurisdictional standards

¹⁹ Intersection is assumed to have a traffic signal and westbound left-turn lane constructed by TriMet.

REGIONAL TRANSPORTATION PLAN (RTP) COMPLIANCE

The projects identified in the master plan list and further refined in the action plan list are consistent with the Metro 2035 Regional Transportation Plan (RTP) goals for regional mobility and non-SOV modal targets. It is expected that the City would continue coordination with Metro and Clackamas County as other plans are updated to maintain consistency and coordination on projects that are regionally implemented.

9

Freight Element



This chapter summarizes strategies to address the future needs of Milwaukie's freight system. The Freight Plan is intended to outline all freight needs over the next 22 years, develop projects to address those needs and identify costs for those projects.

The quality of the local freight network, i.e., those transportation facilities necessary for the movement of bulk goods and materials, is essential to the economic health of the city. While all cities have some need for local delivery of goods, a majority of Milwaukie's employment is in the heavy manufacturing, warehousing, and distribution sectors. These employment sectors are dependent on the efficient movement of large quantities of both raw materials and products. A well-functioning and reliable system for the movement of freight into and out of Milwaukie contributes significantly to the City's ability to attract and retain industrial investment—and the jobs and tax proceeds that come with that investment.

TSP GOAL AND POLICY FRAMEWORK

Milwaukie has developed a set of goals to guide the development of its transportation system (see Chapter 2). Several of these TSP Goals guide Milwaukie's policies on freight access and connectivity, specifically the following:

- **Goal 1 Livability** guides the City to protect residential neighborhoods from excessive noise and pollutants associated with freight transportation.
- **Goal 4 Quality Design** calls for street designs that to support the streets' intended uses, including truck turning movements, as applicable.
- **Goal 5 Reliability and Mobility** calls for maintaining traffic flow and mobility on arterial and collector roadways.
- **Goal 6 Compatibility** directs the City to coordinate with ODOT to address improvements to the commercial railroad system and the State highway system within Milwaukie.
- **Goal 9 Economic Vitality** calls for a safe and efficient freight system that facilitates the movement of goods.

NEEDS

This section outlines the basic needs for freight in Milwaukie, based on existing deficiencies and future forecasting.

Accessibility

In Milwaukie the land uses that are most associated with freight movement are located north of downtown along Hwy 99E (McLoughlin Blvd) and in southeast Milwaukie along Hwy 224. The function of these highways in these areas is critical to serving the movement of freight and goods. Both of these industrial areas are accessible by truck and rail. While rail access tends to function well (despite limitations due to Union Pacific's scheduling priorities), truck access is constrained and is projected to become more problematic as traffic volumes increase in the future (see Chapter 8). A third industrial area in the city along Johnson Creek Blvd, though smaller than the others, is also highly constrained by the transportation system.

The north Milwaukie industrial area (defined as the area south of city limits, west of the Union Pacific Railroad, east of 17th Ave and north of Hwy 224) has limited access to and from Hwy 99E. The eastern half of the area is particularly difficult to access: automobiles can only enter via the signalized intersections of Ochoco St/Hwy 99E and Milport Rd/Hwy 99E. Left turns from Hwy 99E at both of these locations are prohibited and right turns are allowed only at Ochoco St. Together these restrictions force trucks to use the frontage roads of Main St (on the east side of Hwy 99E) and Frontage Rd (to the west of Hwy 99E). Although restricted turn movements from Hwy 99E in this area improve through-vehicle performance and reduces delay on Hwy 99E, it forces freight vehicles to attempt difficult turning maneuvers and to travel out of their intended direction.

The intersection configurations at and near the Hwy 99E/Milport Rd intersection limit the utility of the intersection. The two frontage roads are very close to Hwy 99E. The stacking distance on Milport Rd between Hwy 99E and Frontage Rd is approximately 70 feet; the distance between Main St and Hwy 99E is just fifty feet, barely enough room to store one large trailer semi-truck. In addition, the alignment of the all-way stop control intersection of Main St/Milport Rd makes it particularly difficult for trucks to turn from Main St onto Hwy 99E.

The International Way industrial area is north of Hwy 224, between 37th Ave to the west, Lake Rd to the east, and Railroad Ave to the north. Access to and from the area is via three intersections: the signalized intersection of International Way, 37th Ave and Hwy 224; a signalized intersection at Freeman Way and Hwy 224; and a signalized intersection of International Way and Lake Rd, which is approximately 300 feet from the interchange of Lake Rd with Hwy 224. As discussed in Chapter 8, the intersection at 37th Ave and Hwy 224 is not well configured. The two intersections on 37th Ave are approximately 70 feet apart, making it difficult for trucks to access Hwy 224 because there is only space for one truck to wait for the signal to turn green and allow access to Hwy 224. A second concern is the curvature of the approach to Harmony Rd and Lake Rd at the eastern end of International Way, which is difficult for trucks to maneuver.

Ingress and egress to the third industrial area in Milwaukie, in the northeast corner of the city, is provided via Johnson Creek Blvd. Johnson Creek Blvd however, is limited to two axle-vehicles to the west of 45th Ave, effectively prohibiting heavy truck access to the west. The result is that trucks traveling to and from this area with origins or destinations in that direction must travel south via Linwood Ave, adding several miles of out-of-direction travel.

Connectivity

Several significant regional facilities that provide for regional movement of freight are located, in part, within Milwaukie. These are most notably the Union Pacific Railroad's (UPRR) Brooklyn Sub mainline and the Hwy 99E, and Hwy 224 mobility corridor. Access to these facilities allows Milwaukie businesses to connect to the national transportation network via Brooklyn Yard and I-205. Informal surveys of industrial businesses have confirmed that most out-bound and in-bound heavy truck trips use I-205. While these regional facilities do provide mobility for local users, they are operated by ODOT and UPRR primarily for the benefit of regional through-movements.

There is a need to minimize delay in accessing regional freight facilities. Milwaukie should acknowledge the need to serve those through-movements, while also striving to preserve and expand access for trips originating or terminating within the city. This is a primary concern for the north industrial area due to the out-of-direction travel required to access the area and the delays associated with leaving the area.

In addition, local and regional freight system users would benefit from improvements in the connections between these regional routes. Currently Hwy 99E and Hwy 224 connect with a partial interchange that facilitates direct access between southbound Hwy 99E to eastbound Hwy 224, and westbound Hwy 224 to northbound Hwy 99E. Other movements are not directly accommodated and require vehicles to utilize city streets such as 17th Ave (Hwy 224 westbound to Hwy 99E southbound) and Harrison St (Hwy 99E northbound to Hwy 224 eastbound).

Rail Crossings

The majority of the at-grade rail crossings in Milwaukie are constructed of asphalt. This surface material becomes uneven and deteriorates more quickly than concrete or rubberized materials that are more commonly used at railroad crossings. Elderly and disabled citizens, as well as adults with baby strollers, are experiencing difficulties walking across the asphalt railroad crossings. Bicyclists may also have difficulty crossing the railroad tracks at these locations. These are of primary concern on arterials and collectors, where vehicle traffic is the heaviest and the asphalt material deteriorates at a faster rate.

As discussed in Chapter 8, all at-grade rail crossings, regardless of materials, cause interruptions to the transportation network. These are particularly acute at crossings such as the UPRR crossing of Harrison St and the UPRR crossing of Harmony Rd, where frequent train crossings interrupt important auto circulation routes and impact emergency services.

Truck Maneuverability

Truck turning movements are difficult due to intersection alignments and/or geometries at several locations, including the Main St and Omark Dr intersections with Mailwell Dr.

Neighborhood Livability

Heavy vehicles and trains frequently create real and perceived neighborhood impacts. The impacts include noise, vibration, safety, aesthetics, and air quality. They are particularly noticeable when trains or trucks pass through or near residential neighborhoods.

RECOMMENDATIONS

Strategies

To address the needs described above, the City will pursue the following strategies.

Accessibility

Several alternatives for improving truck access and local circulation in the North Milwaukie industrial area were examined during the preparation of the 2007 TSP update. The purpose of this detailed analysis was to develop and analyze various alternatives to improve access and circulation for freight to and from this area. The work was conducted with an awareness of the potential impacts that the Portland-Milwaukie Light Rail (PMLR) project could have on access to the area. To help develop alternatives that would meet the access and circulation needs of this area, a separate sub-group of the Freight Working Group was established to help develop a problem statement, goal statement, and evaluation criteria to help guide the development and analysis of the various alternatives.

The preferred alternative among the participants of the sub-group was the construction of an overpass of Hwy 99E at Ochoco St with alternative access to Hwy 99E via on/off lanes, and restricting access at Milport Rd to right-out movements, in concert with a "Tillamook" branch alignment of light rail. The detailed analysis for this process can be found in Appendix D. Because this access issue sits within the larger question of the best design of the Hwy 99E/Hwy 224 corridor, the Freight Working Group recommended forwarding these findings to a future Hwy 99E/Hwy 224 Corridor Refinement Plan, rather than including a specific improvement or set of improvements in the Freight Master Plan.

Rail Crossings

Improving the quality of the materials at at-grade crossings and pursuing the grade separation of key crossings, such as the UPRR and Harrison St, and the UPRR and Harmony Rd crossings, are included in the master plan. The City should not support the introduction of any new at-grade heavy rail crossings in the city.

Truck Maneuverability

Intersections that are part of the local freight network or provide access to regional facilities ought to be designed to fully accommodate truck turning maneuvers. As part of new design guidelines, the City should adopt clear standards for adequate turning radii, lane widths and other geometric requirements of heavy vehicles for those streets that are local preferred freight routes or internal circulation routes within industrial areas. The master plan includes a project to correct two Mailwell Dr intersections that are currently problematic for truck maneuvers.

Neighborhood Livability

In support of minimizing residential impacts, the City actively encourages all heavy vehicles to use, to the extent practical, the identified local freight routes. Potential strategies to reduce freight traffic on local streets not identified as freight routes, such as traffic calming and diversion treatments, can be found in Chapter 11 Neighborhood Traffic Management. The rail crossing improvements described above also address livability issues. The rail crossing safety improvements, which could allow the creation of a "Quiet Zone," included in the Street Network Master Plan would also reduce the negative impacts of freight facilities on residential areas.

Master Plan

A list of potential freight projects was developed to meet the identified needs for freight. These projects form the basis for the Freight Master Plan. The master plan shown in Figure 9-1 and summarized in Table 9-1 is an overall plan and summarizes the "wish list" of freight related projects in Milwaukie. The projects on the master plan were then used to create a Freight Action Plan. The action plan consists of projects that the community identified as higher priority projects and that the City could reasonably expect to fund. As development occurs, streets are rebuilt and as other opportunities (grant programs) arise, other projects on the master plan will be pursued.

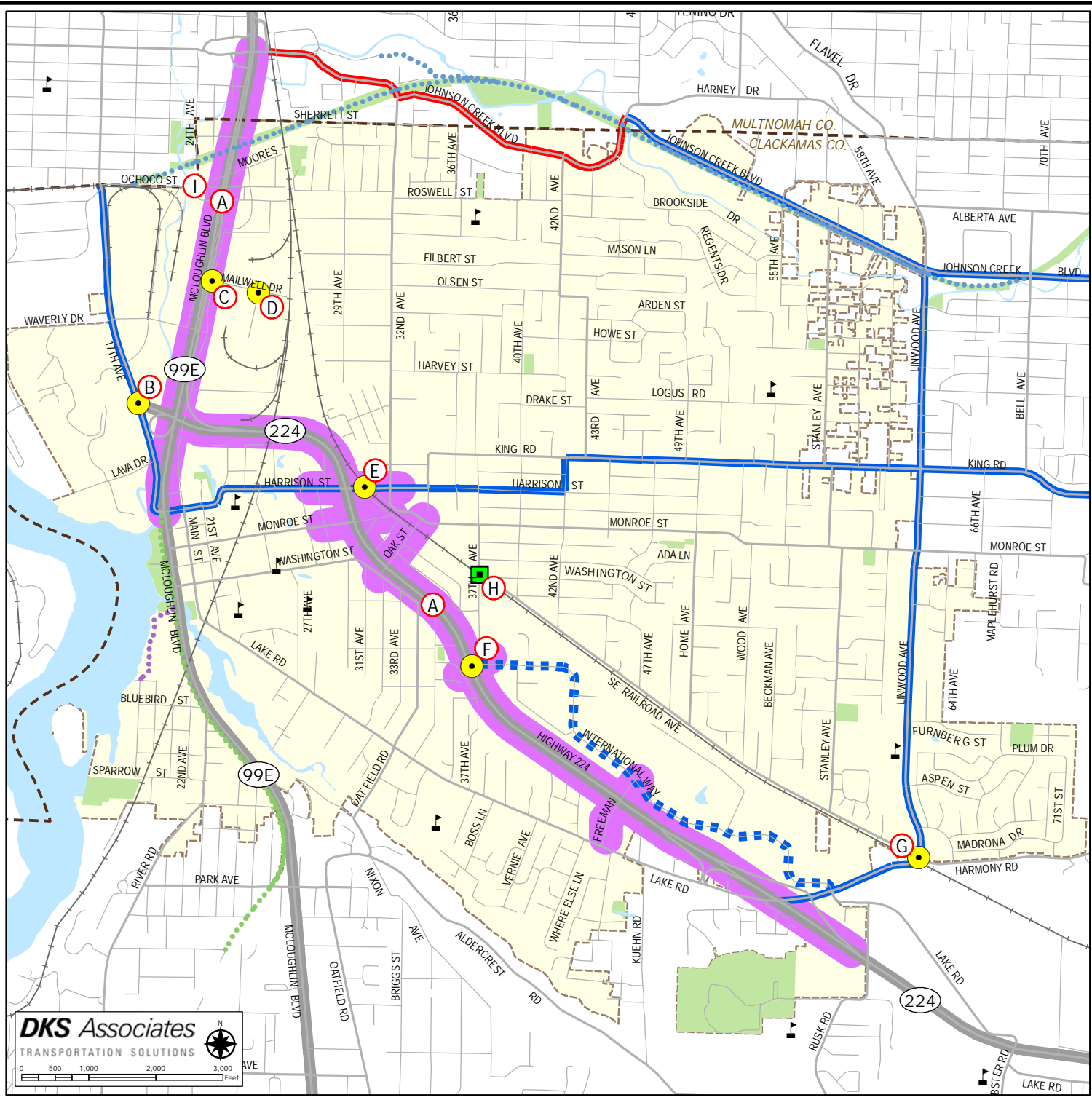
The planning level cost estimates provided for each project are based on general unit costs for transportation improvements, but do not reflect the unique project elements that can significantly add to the estimated project costs. Each of these project costs will need further refinement to detail right-of-way requirements and costs associated with specific design details as projects are pursued.



Transportation System Plan

FIGURE 9-1

FREIGHT MASTER PLAN November 2013



LEGEND

Existing Freight Routes	Proposed Improvements
Major Regional	Intersection Improvement
Minor Preferred (Local)	Intersection Material Upgrade
Weight Restricted Minor Preferred (Local)	Corridor Refinement Plan
Minor Preferred Freight Route (Local)*	Minor Preferred Freight Route (Local)*
Major Roads	County Line
Streets	Parks
Railroad	Water
Springwater Trail	City Limits
Kellogg Creek Trail	
Trolley Trail	

PROPOSED PROJECTS

- Improve Corridor**
- A** Conduct Refinement Plan for HWY 99E/HWY 224 focused on motor vehicle and freight mobility.
 - HWY 99E Project Limits: Tacoma St to 17th Ave
 - HWY 224 Project Limits: HWY 99E to Lake Rd Interchange
- Improve Intersection**
- B** 17th Ave/HWY 224 Upgrade intersection turning radii to better accommodate freight movements
 - C** Main St/Mailwell Dr Upgrade intersection turning radii to better accommodate freight movements
 - D** Mailwell Dr/Omark Dr Upgrade intersection turning radii to better accommodate freight movements
 - E** Harrison St/Union Pacific Railroad Crossing Upgrade crossing to grade separated facility (outcome of crossing dependant upon 99E/224 Refinement Plan findings)
 - F** HWY 224/37th Ave Consolidate two northern legs of 37th Ave and Industrial Way into one leg at HWY 224.
 - G** Linwood/Harmony/Lake Road Intersection Improvements Add northbound right turn lane and eastbound right turn lane AND/OR grade separate Harmony Road from Union Pacific Railroad and align as a through east-west movement
 - H** Railroad Crossing Improvements at 37th Ave Improve road transition to railroad crossing
 - I** Signage and Intersection Improvements at McLoughlin Boulevard and Ochocho St. Establish signage for trucks and improve intersection (TSAP)

Table 9-1 Freight Master Plan Projects

Map ID ¹	Priority	Type	Project Name	Project Description	From	To	Cost(s) (\$1,000s ²)
High Priority Projects							
A	High	C	Hwy 224 & Hwy 99E Refinement Plan	Conduct refinement study that focuses on minimizing barrier effect and improving auto and freight mobility.	Hwy 99E Project Limits: Tacoma St to 17 th Ave	Hwy 224 Project Limits: Hwy 99E to Lake Rd Interchange	\$270
E	High	C	Harrison St Railroad Crossing Separation	Upgrade Harrison crossing of Union Pacific Railroad tracks to grade-separated facility. Assess as part of Hwy 224 & Hwy 99E Refinement Plan.	Location-specific	Location-specific	\$30,700
F	High	C	Hwy 224 Intersection Improvements at 37 th Ave	Consolidate the two northern legs of 37 th Ave and International Way into one leg at Hwy 224.	Location-specific	Location-specific	\$2,100
I	High	C	Signage and Intersection Improvements at McLoughlin Blvd and Ochoco St	Establish signage for trucks and improve intersection. (TSAP)	Location-specific	Location-specific	\$1,600
Medium Priority Projects							
C	Med	C	Intersection Improvements at Main St and Mailwell Dr	Upgrade intersection turning radii to better accommodate freight movements.	Location-specific	Location-specific	\$60
Low Priority Projects							
B	Low	C	Intersection Improvements at Hwy 224 and 17 th Ave	Upgrade intersection turning radii to better accommodate freight movements.	Location-specific	Location-specific	\$60
D	Low	C	Intersection Improvements at Mailwell Dr and Omark Dr	Upgrade intersection turning radii to better accommodate freight movements.	Location-specific	Location-specific	\$60

Notes:

C = Capital Project High = High priority TSAP = Tacoma Station Area Plan
 O = Operational Project Med = Medium priority
 P = Policy Project Low = Low priority

¹ See Figure 9-1.

² Project costs are order-of-magnitude estimates and are in 2012 dollars. Future costs may be more due to inflation. In the case of operational projects, estimated costs are for the entire 22-year planning period.

Action Plan

The Freight Action Plan (Table 9-2) identifies the highest priority projects that are reasonably expected to be funded with local funds by 2035, which meets the requirements of the State's Transportation Planning Rule.³ The action plan project list is based upon a 2007 citywide project ranking process. In 2007, all of the modal master plan projects were ranked by the TSP Advisory Committee after consideration of the Working Groups' priorities, other public support for the project, and how well each project implements the TSP goals and policies. For the 2013 TSP Update, City staff reassessed the prioritization of all projects, incorporating public comments gathered at and around a public meeting in June 2013. Action plan projects that were completed since 2007 were removed from the action plan and new projects identified as top priorities were added.

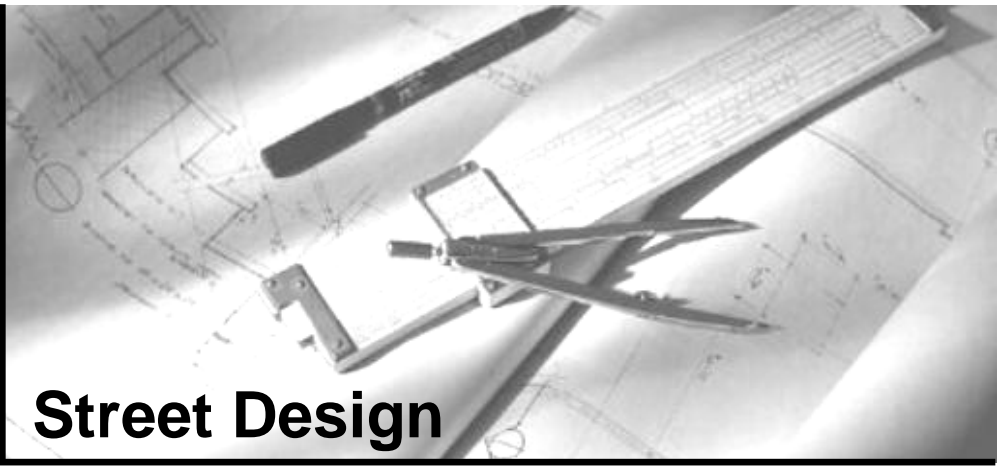
Table 9-2 Freight Action Plan

Project Name	Project Description	From	To	Project Cost (\$1,000s)	Direct Funding or Grant Match
Hwy 224 & Hwy 99E Refinement Plan	Conduct refinement study that focuses on minimizing barrier effect and improving auto and freight mobility.	Hwy 99E Project Limits: Tacoma St to 17 th Ave	Hwy 224 Project Limits: Hwy 99E to Lake Rd Interchange	\$270	Match

³ OAR Chapter 660, Department of Land Conservation and Development, Division 012, Transportation Planning, adopted on March 15, 2005, effective April 2005.

10

Street Design



This chapter describes the importance of street design, why it matters, and the street design options available in Milwaukie. This chapter also explores the benefits of a well-designed street and illustrates the relationship between street design, functional classification, and land use. Street design recommendations in this chapter are policy-based, not project-based. They direct the City to implement balanced and flexible street design standards that reflect the community's vision and include new and innovative design options.

GOALS AND POLICIES

Milwaukie has developed a set of goals to guide the development of its transportation system (see Chapter 2). Listed below are the specific TSP Goals that guide the City's policies on street design:

- **Goal 1 Livability** guides the City to design and construct transportation facilities in a manner that enhances livability.
- **Goal 2 Safety** guides the City to design safe transportation facilities.
- **Goal 4 Quality Design** guides the City to design streets to support their intended users and calls for the implementation of street design standards that promote context-sensitive transportation facilities that fit the physical context, respond to environmental resources, and maintain safety and mobility.
- **Goal 6 Sustainability** guides the City to take the natural environment into account when planning and designing transportation facilities.

STREET DESIGN

What is Street Design

A street's design determines how it will look and function. How a street looks and functions is ultimately dependent upon which street elements are included, their dimensions, and how they relate to each other. Street elements may include, but are not limited to: travel lanes, parking

lanes, bicycle lanes, green zones,¹ pedestrian facilities, traffic-calming devices, and green street treatments. A street with two travel lanes and a gravel shoulder, for example, looks very different than one with four travel lanes and sidewalks. These two types of streets also function differently. The two-lane street likely has lower traffic volumes but, without pedestrian facilities, does not support safe pedestrian travel. The four-lane street likely has higher traffic volumes and, with sidewalks, supports safe pedestrian travel; however, without bike lanes, it probably does not support safe bicycle travel.

Since different streets serve different purposes, a functional classification system, which is a hierarchy of street designations, provides a framework for identifying which street elements to include in a street's design. A street's functional classification does not dictate which street elements to include. It does, however, provide a framework for determining the size and type of street elements to consider.

The City's functional classification system is used to balance the opposing needs for both mobility and access. These functions are opposing, since high speeds and continuous movement are desirable for mobility, while low speeds and traffic breaks are desirable for access to private property. Streets with a higher classification, such as arterial streets, emphasize a higher level of mobility for through-movement. They look and function very differently than streets with a lower classification, such as local streets, which emphasize the land access function. The different functional classifications are more fully discussed in Chapter 8.

Why Milwaukie Has Street Design Options

The City's street design standards are contained in and/or referenced by the Milwaukie Municipal Code which is the City's main regulatory document. As required by the Code, street design standards are applied to new streets and to existing streets when development triggers the need for additional public street improvements. Since the majority of land in Milwaukie has already been developed, street design standards are most frequently applied to existing streets, many of which were only partially improved when constructed.² Many of the city's residential streets, for example, were constructed without bicycle, pedestrian, or stormwater facilities. Retrofitting an existing street with needed improvements is typically a much more complicated process, both in terms of design and construction, than constructing a new street.

The City has some flexibility when applying its existing design standards. The addition, alteration, or elimination of most street elements requires extensive review. When this type of review occurs, the City's existing design standards identify the elements that should be included and their required and minimum allowed dimensions. They also identify which elements are most important to include when right-of-way is insufficient or which elements are most appropriate to alter or eliminate in certain situations.

The City's existing street design standards allow for more innovative types of designs, such as skinny streets, green streets, and alternative pedestrian facilities, all of which the community strongly supports. Green street development, in particular, has far reaching benefits for the region and the city. In addition to reducing stormwater runoff to streams and rivers, which improves water quality and wildlife habitat in general, green street development would help recharge the local aquifer, the city's main water supply.

¹ The green zone is the area between the curb and sidewalk and is commonly called a landscape strip.

² Partially improved streets are often referred to as incomplete streets.

For these reasons, the City has flexibility when applying existing street design standards, more design guidance, and more street design options. Three of the main reasons are summarized below.

- When making improvements to existing streets, existing street design standards often need to be modified to "fit" the existing street conditions.
- Even when a typical street design would work, more environmentally friendly designs and alternative pedestrian facilities may be appropriate.
- More design flexibility and options enable the City to allow street improvements that respond to the character of the surrounding natural and built environments.

The City recognizes the diversity of public opinion and development patterns that exist within Milwaukie and acknowledges that street design should not be a "one size fits all" approach. That is why the City has multiple street design options that support a street's intended users and its functional classification while also responding to adjacent land uses, neighborhood character, and environmental considerations.

Why Street Design Matters

Streets are the cornerstone of our transportation network. They are used by all modes of travel for a wide variety of commercial, recreational, and travel purposes. Since they traverse the entire city they also greatly influence neighborhood character. Street design matters because well-designed streets are a significant community asset. Poorly designed streets, on the other hand, can have a detrimental effect on commercial activities, recreational opportunities, personal mobility, emergency response, and property values. Since the design of a street is so closely tied to how it performs and how people experience the city, it is important for the City to carefully consider how it wants its streets to look and function and to design them accordingly.

Benefits of Good Street Design

The benefits of good street design occur on many levels. Benefits vary depending on the function of the street and the type of design implemented, but may include:

- Improved livability.
- Increased safety for pedestrians, bicyclists, drivers, and transit riders.
- Increased pedestrian and bicycle activity.
- Increased social and recreational opportunities.
- Decreased environmental impacts through localized stormwater management or reduced stormwater runoff.
- Enhanced air and water quality.
- Street beautification.
- Increased property values.

Many of these benefits come from enhancements to pedestrian and green zones, which are the areas between the curb (or edge of roadway where no curb exists) and the outer edge of the right-of-way (see Figure 10-1). The green zone acts as a buffer between motor vehicle traffic and pedestrian traffic. This buffer area increases pedestrian comfort and safety, reduces the affect of road spray on pedestrians, allows for more separation between pedestrians and vehicle exhaust fumes, and when combined with mature street trees, can reduce vehicle speeds by giving the appearance of a narrower street. Reduced vehicle speeds are a safety benefit for all modes of travel, and an environment that supports walking, creates opportunities for social

contact, reduces motor vehicle reliance, and contributes to healthier and more active communities.

As its name implies, the green zone provides a space for street trees and other plantings that benefit the environment through improved air and water quality. When appropriately designed, green zone plantings can also manage local stormwater runoff, which reduces the transportation system's impact on local streams and rivers. The green zone also provides a space for placement of utilities, fire hydrants, and other street furniture, so that the sidewalk can remain uncluttered, allowing for unimpeded pedestrian passage. Additionally, this area can be used for the placement of transit shelters and benches, which increases the safety and comfort of transit users.

STREET DESIGN ELEMENTS

The purpose of this chapter is to create a policy framework that will guide street design decisions to meet the needs and values of the community. The first step in this process is to describe the different street elements, which are listed below. This is followed by a discussion about which elements are optional and which are required (see the Street Design Cross Sections section) and what alternative design options are available and preferred by the community (see the Street Design Alternatives section).

All streets are composed of a number of different elements; however, not all elements are included on all streets. A street's functional classification, adjacent land uses, and available right-of-way width all influence which elements are included. When a specific element is included, it is generally located in the same location on the street relative to other elements. However, an element's design, dimension, and relationship to adjacent elements can and should vary depending upon neighborhood character, traffic management needs, and/or social, cultural, or environmental factors.

The following is a description of the different street elements or zones that comprise most streets.

Development Zone

The development zone is not in, but adjoins, the public right-of-way. In commercial or industrial zones, a building face may clearly define the edge of the right-of-way. In residential zones, the outer edge of the right-of-way is often not clearly or accurately marked. Access to the development zone is almost always through the public right-of-way in the form of a driveway or sidewalk.

Pedestrian Zone

The pedestrian zone is the public space between the development zone and the green zone. This area should support pedestrian activities by providing a comfortable space for walking, socializing, and accessing private property and buildings in the development zone. The needs for this space, its width and lighting, for example, depend upon the functional classification of the street and adjacent land uses. In general, pedestrian zones should be wider in dense commercial zones and on streets with high traffic volumes and speeds and may be narrower on local streets with low traffic volumes.

A typical pedestrian zone is at least five feet wide when adjacent to a green zone and at least six feet wide when adjacent to a street zone.

Green Zone

The green zone is the public space that separates the pedestrian zone from the street zone. It functions as a buffer between pedestrians and motor vehicle, bicycle, and other street zone users. It also offers a place to locate street trees, bike racks, street furniture, transit amenities, utilities, and plantings designed to manage stormwater runoff. The green zone can provide visual appeal for all users by balancing the hard concrete and asphalt surfaces from which a street is constructed. A green zone with mature street trees has the added benefit of framing the street and shielding pedestrians from the elements.

A typical green zone is at least five feet wide.

Street Zone

The street zone may contain many or few elements, depending on its functional classification. Typical elements include parking lane(s), turning lane(s), travel lane(s), and bike lane(s) or mixed vehicle lane(s) that include bicycles. Skinny streets or one-way streets offer different street zone variations as well. In general, the street zone serves as a conduit for mobility and access to private property. Streets that serve an important mobility function (e.g., arterials and collectors) are typically wider than streets that primarily exist to provide access to property (e.g., local).

Typical lane widths:

- Parking lane, 6-8 ft.
- Bicycle lane, 5-6 ft.
- Travel lane, 9-12 ft.³
- Shared travel lane, 14-16 ft.

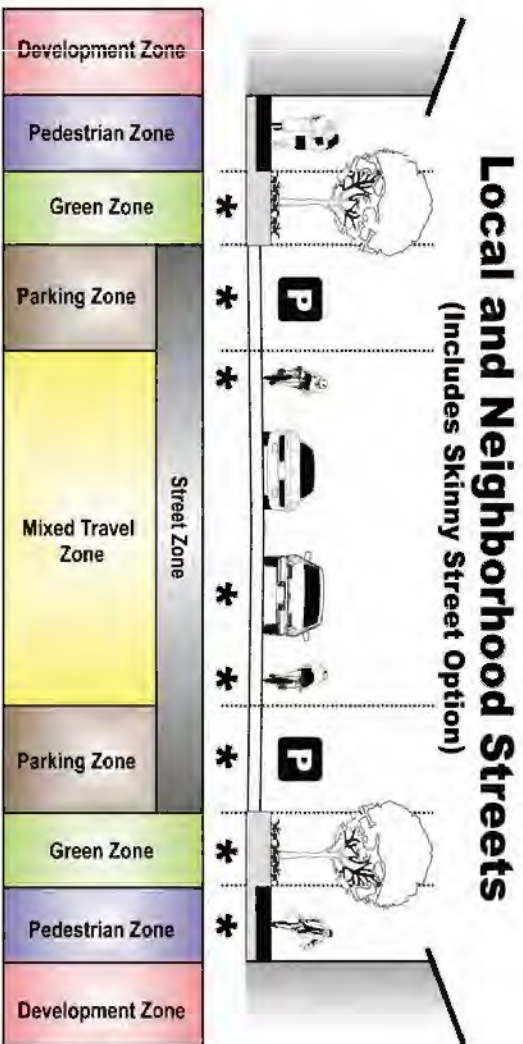
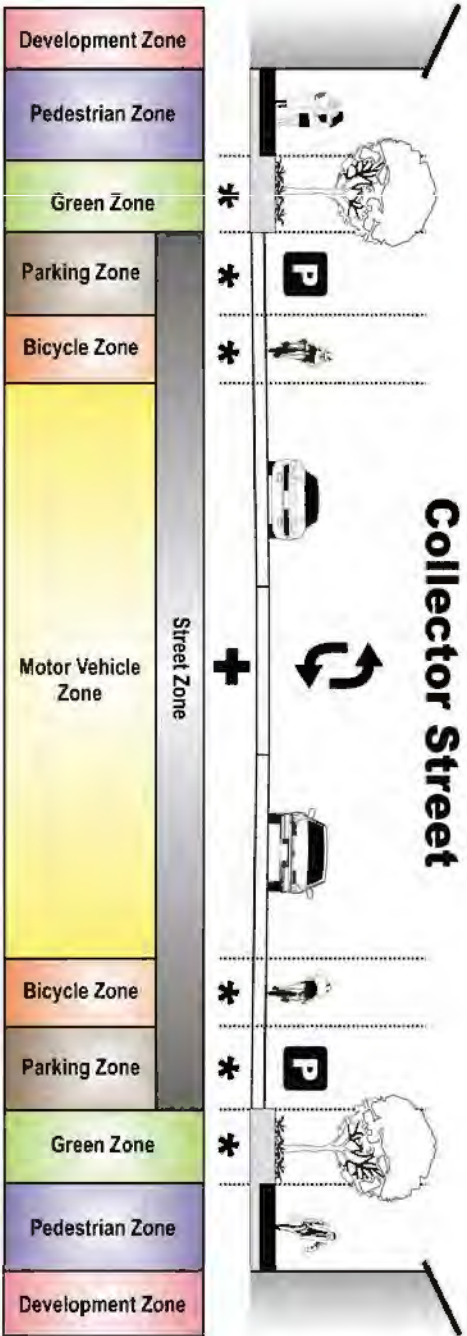
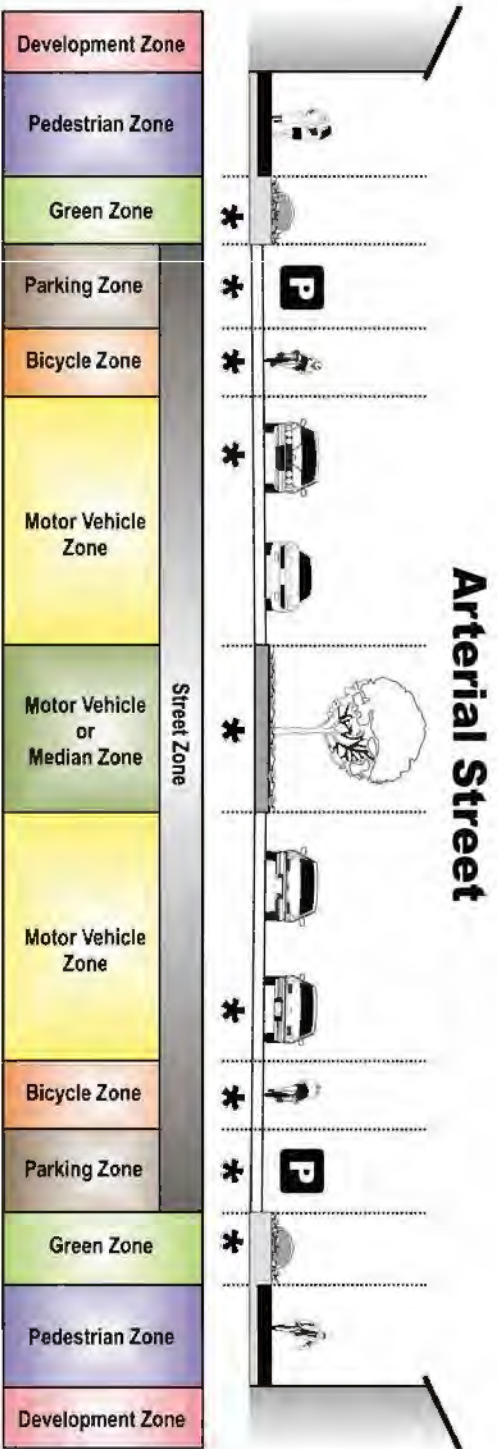
In addition to vehicle and bicycle traffic, the street zone also contains pedestrian traffic at street intersections and midblock pedestrian crossings. To enhance pedestrian safety at intersection crosswalks and midblock locations, crossing locations should be visible and clearly understood by both drivers and pedestrians. The street zone may also contain green street treatments or traffic management devices to slow traffic or deter cut-through traffic. (See Chapter 11 for additional discussion of neighborhood traffic management.)

STREET DESIGN CROSS SECTIONS

Figure 10-1 contains cross sections for four of the City's street functional classifications. This figure lays the foundation for more flexible design standards. Street design elements marked with asterisks are optional when right-of-way width is insufficient to include all elements. Elements not marked with asterisks are required under all circumstances. The local and neighborhood street cross section, for example, indicates that, at a minimum, one travel lane and one pedestrian facility is required if there is truly insufficient right-of-way width to accommodate any other elements.

The local and neighborhood cross section also includes a skinny street option since a skinny street can contain all of the same elements as a local or neighborhood street. The difference between a skinny street and a local or neighborhood street is that a skinny street typically has narrower elements and/or overlapping parking and mixed travel zones.

³ A typical travel lane is between 10 and 11 feet wide. Narrower lane widths are appropriate on lower-volume streets; wider lane widths are appropriate on higher-volume streets and on freight and transit routes.



LEGEND

- * -Constrained Right-of-Way Optional Element
- + -Where Warranted

Information Sources: DKS Associates

DKS Associates

**STREET DESIGN CROSS SECTIONS
BY FUNCTIONAL CLASSIFICATION**

**FIGURE
10-1**

Variations to these cross sections may also be welcomed and/or required by the City when:

- Environmentally beneficial or green street treatments are proposed or needed.
- A street is an identified bikeway or pedestrian walkway in the TSP master plan.
- Existing structures are unusually close to the right-of-way.




The cross sections in Figure 10-1 are shown without dimensions, as the intent is to provide a policy framework—not specific design details—for more flexible street design standards.

STREET DESIGN ALTERNATIVES

Pedestrian Facilities

Three pedestrian facility design alternatives are shown in Table 10-1.

Table 10-1 Pedestrian Facility Design Alternatives

Design Alternative	Description	
Vertical and Horizontal Separation	Separation from the street zone both vertically by a curb and horizontally by a green zone. This design alternative can incorporate green street treatments as outlined in the following section on green street design.	
Horizontal Separation	Separation from the street zone horizontally by a green zone or other horizontal element or barrier. The pedestrian zone is at the same grade as the street zone. This design alternative can incorporate green street treatments as outlined in the following section on green street design.	
Vertical Separation	Separation from the street zone vertically by a curb. The pedestrian zone is located "curb tight" against the street zone with no horizontal separation. Pedestrians could still be buffered from vehicular traffic in the street zone by on-street parking and/or bicycle lanes. If wide enough, this design alternative could incorporate tree wells for street trees.	

Source: DKS Associates

Vertical and horizontal separation is the community preferred pedestrian facility design in most situations and especially on streets with higher traffic volumes and speeds. Where traffic volumes and speeds are low, horizontal separation is preferred by the community over vertical separation, especially in neighborhoods that desire a less traditional sidewalk design. Two-sided pedestrian facilities are preferred, but one-sided pedestrian facilities are acceptable and even desirable under certain circumstances. When utilizing pedestrian facility design standards, it will be essential that the City identify the circumstances and the process by which one design alternative is chosen or required over another.

It is worth noting that the two preferred pedestrian facility designs include a green zone. In addition to horizontally separating pedestrians from the street zone, the pedestrian facilities that

include a green zone are preferred because of the additional aesthetic and environmental benefits the green zone provides pedestrians and the street as a whole.

Green Streets

A traditional stormwater management system for a street uses a curb and gutter to capture and convey stormwater runoff to a catch basin and then a pipe. Piped runoff is then discharged offsite into a stream or river. A green street uses a different stormwater management approach. Instead of discharging stormwater offsite, a green street incorporates a stormwater management system into the right-of-way that allows most stormwater runoff to remain onsite, where it is absorbed and cleansed through natural biological processes. Green street treatments capture and treat stormwater runoff locally, thereby protecting streams, groundwater, and wildlife habitat. Additionally, since Milwaukie's water supply comes from local wells, it is in the city's best interest to incorporate green zones and green street treatments into its streets as much as possible to protect and maintain the local groundwater supply—a vital city resource.

Most green street treatments have all of the benefits associated with the green zone but require regular maintenance to maintain their functionality and appearance. However, unlike traditional piped stormwater systems, maintenance usually does not require specialized equipment or training. Since some treatments can easily be incorporated into green zones, center medians, or the area usually occupied by parking lanes, streets can often be retrofitted with green street treatments without having to substantially alter any existing street elements or the right-of-way width.

Green street treatments are not dependent upon functional classification and can be incorporated into all street types. Table 10-2 below shows the different green street treatments and the zones in which they may be applicable.

Table 10-2 Green Street Design Treatments⁴

Treatment	Application	How it Works	Application Zone		
			Pedestrian	Green	Street
			■ Recommended		□ Optional
			□ Not Recommended		
Rainwater Harvesting	Aboveground or subgrade containers that capture and reuse stormwater runoff for landscape irrigation.	Stormwater is conveyed to storage facilities during the wet season for use during the dry season.	■	■	□
Permeable Paving	Replacement of impermeable surfaces with permeable materials, such as permeable pavement, concrete, or paving blocks.	Permeable materials allow water infiltration through the surface to the subgrade.	■	■	■

⁴ The soils within an area where green street treatments could be implemented need to be tested to determine the rate of infiltration they can sustain. In addition to green street treatments, traditional stormwater management facilities need to be designed to control overflow if the capacities of the green street treatments are exceeded.

Treatment	Application	How it Works	Application Zone		
			Pedestrian	Green	Street
			■ Recommended		□ Optional
			□ Not Recommended		
Bio-retention (Raingardens)	Aboveground or subgrade containers that promote infiltration and evapotranspiration of stormwater.	Engineered or amended soils and vegetation are used to promote these processes.	□	■	□
Bio-swales	Subgrade channels with vegetation that convey and treat stormwater.	Vegetation is used to control flow velocities and settle pollutants.	□	■	□ ⁵

When utilizing green street design standards, it will be essential that the City identify the circumstances under which green street treatments would be required or recommended. Additionally, the City should ensure that green street treatments receive ongoing maintenance to preserve their functionality and appearance.

Skinny Streets

A skinny street is narrower than a normal street and is typically constructed when less paved surface area is desired or in areas with limited rights-of-way or physical constraints. Skinny street designs are typically only considered for streets that have lower traffic volumes and speeds, such as local or neighborhood streets, or in one-way couplet situations. Skinny streets function like regular streets and often have the following additional benefits:

- Slower vehicle speeds.
- Enhanced bicycle and pedestrian safety due to slower vehicle speeds.
- Reduced right-of-way impacts on adjacent properties.
- Reduced stormwater runoff and other environmental impacts due to reduced impervious surface area.

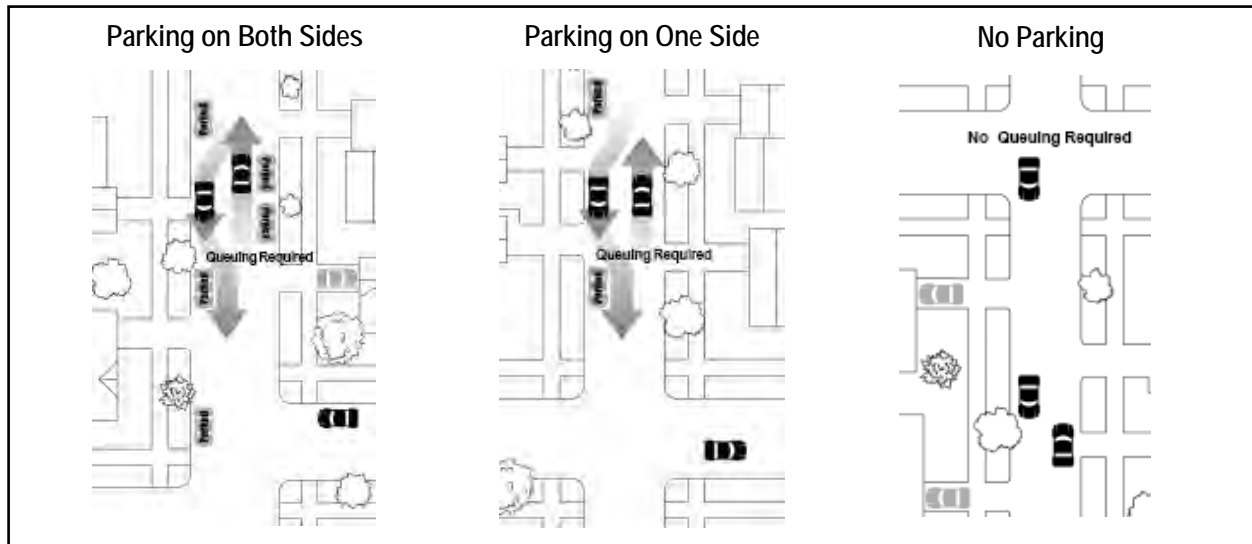
For emergency service personnel to be able to respond to emergencies in a timely manner, the Fire Code recommends that street zones have a minimum width of 20 feet to allow for passage and equipment set up.⁶ Solid waste collectors and delivery trucks have similar needs.

Figure 10-2 illustrates three possible skinny street design options. These design options include parking on both sides of the street, parking on one side of the street, or parking on neither side of the street. The design option with parking on both sides of the street requires the widest paved street zone, and the design option with no parking requires the narrowest paved street zone. The design options with parking have overlapping travel and parking lanes. As a result, queuing may be required, which is where one vehicle waits in an open parking area or driveway for the other vehicle to pass.

⁵ With the exception of medians.

⁶ *Neighborhood Street Design Guidelines, An Oregon Guide for Reducing Street Widths*. State of Oregon. November 2000.

Figure 10-2 Skinny Street Design Options



When utilizing skinny street design standards, it will be essential that the City identify under what circumstances skinny street designs would be required or recommended.

RECOMMENDATIONS

In summary, the recommended actions and policy directions listed below call for the City to utilize balanced and flexible street design standards that reflect the community's vision and that include new and innovative design options, including green streets, skinny streets, and alternative pedestrian facility designs.

Design Standards

Recommended Action

Maintain a baseline cross section for each street functional classification (with preferred dimensions for all street elements) and a street design prioritization approach when the baseline elements do not fit. Maintain street design standards for green streets, skinny streets, and alternative pedestrian facilities and identify under what circumstances alternative designs would be required or recommended. Maintain a list of alternative materials, such as permeable pavers, and identify situations in which alternative materials would be suitable and desirable.

Policy Direction

- Maintain flexibility in street design standards to allow for local design preferences and to avoid costly and time-consuming variance process requirements.
- Balance citywide needs, local design preferences, and best practices when utilizing street design standards.
- Provide for public involvement in the utilization of street design standards and during the design phase of street-related Capital Improvement Projects.
- Consider maintenance costs and issues when utilizing design standards.
- Utilize design standards, including alternative designs, which accommodate emergency response routes and needs.

- Require a minimum of one-sided pedestrian facilities on all streets.
- Require green zones and green street treatments where appropriate and practical.
- Maintain design consistency along a street's length where appropriate.

Green Zone and Green Street Plantings

Recommended Action

Develop a list of appropriate, low-maintenance plant species for use in green zones and green street treatments. Develop street tree replacement policies and regulations.

Policy Direction

- Ensure green zones and green street treatments are planted with appropriate, low-maintenance species.
- Preserve and expand the city's tree canopy.

Maintenance

Policy Direction

- Ensure that green street treatments receive ongoing maintenance to preserve their functionality and appearance.
- Ensure that landscaping in green zones and medians is properly maintained.
- Ensure that street design elements and treatments function as intended.

11

Neighborhood Traffic Management



Neighborhood traffic management is a term used to describe the many and varied traffic management approaches used to reduce the impacts of traffic volumes and speeds on residential neighborhoods and improve safety for pedestrians and bicyclists. This chapter describes the need for neighborhood traffic management, identifies tools that the City can use to slow and/or divert traffic, and outlines a process for implementing neighborhood traffic management measures. It is not the purpose of this chapter to identify streets in need of traffic management or to propose projects at specific locations.

GOALS AND POLICIES

Milwaukie has developed a set of goals to guide the development of its transportation system (see Chapter 2). Listed below are the specific TSP Goals that guide the City's policies on neighborhood traffic management:

- **Goal 1 Livability** guides the City to protect residential neighborhoods from excessive through traffic and travel speeds while providing reasonable access to and from residential areas.
- **Goal 2 Safety** guides the City to maintain a safe transportation system.
- **Goal 4 Quality Design** guides the City to design streets to support their intended users and respond to the surrounding natural and built environments.

The main benefits of effective neighborhood traffic management are improved livability and safety. Reduced vehicle speeds are a safety benefit for all modes of travel. Reduced cut-through traffic improves livability through the reduction of vehicular noise, pollutants, and traffic volumes. Additionally, streets that are used in ways for which they weren't designed lead to congestion and safety hazards.

NEEDS

Most of the land within Milwaukie consists of residential neighborhoods. The city, with just over 20,000 citizens, has a relatively small population compared to the surrounding Portland metropolitan area. Because of Milwaukie's proximity to the city of Portland, its employment centers, and the two major regional routes through the city (Hwys 99E and 224), cut-through traffic and speeding is an ongoing concern for citizens. Cut-through traffic most often occurs when congestion occurs on regional routes and major streets and nonlocal traffic goes in search of less congested or more direct routes. Speeding can occur under many different

circumstances; however, the city has a number of streets that are relatively straight with few intersections or traffic control devices. These types of streets often invite speeding violations.

Neighborhood traffic management is a means to address the negative impacts of unchecked traffic speed and volume on neighborhood streets. Effective use of neighborhood traffic management can address neighborhood needs and concerns, including, but not limited to, the following:

- Speeding.
- Cut-through traffic, especially by heavy freight trucks.
- Bicycle and pedestrian safety.
- Student safety around school zones.

Student safety around school zones has been and continues to be a concern in Milwaukie neighborhoods. In 1995, the Milwaukie Traffic Safety Commission was charged with identifying and implementing school trip safety improvements in collaboration with schools, parent teacher organizations, neighborhood district associations, residents, and staff. The now defunct commission enacted many safety improvements, but not all recommended projects were pursued or implemented. This chapter does not recommend specific traffic management measures at specific locations, such as schools; however, Chapter 5 Pedestrian Element and Chapter 6 Bicycle Element recommend projects that directly address student safety. In addition, the various Neighborhood District Associations can choose to develop neighborhood traffic management plans that identify more specific issues to be addressed.

TOOLS

There are many different measures available in the neighborhood traffic management "tool box," but not all of these measures are appropriate for all streets or in all situations. As with street design, traffic management measures need to take street functional classification, surrounding land uses, existing street design, emergency service provider access needs, and neighborhood preferences into account.

Table 11-1 groups neighborhood traffic management measures into four categories and shows the recommended application based on street functional classification. The four categories are as follows:

- Horizontal deflection (reduces traffic speeds).
- Vertical deflection (reduces traffic speeds).
- Volume control measures (reduces or diverts traffic volumes).
- Other measures.

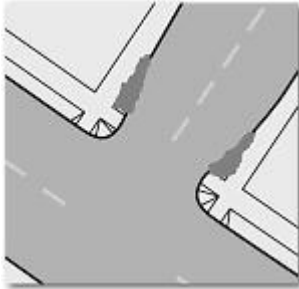
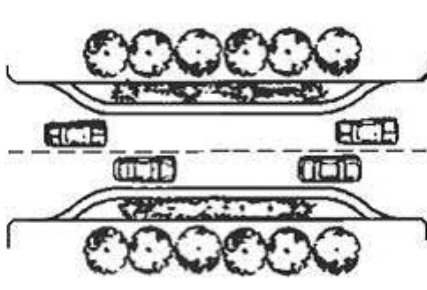
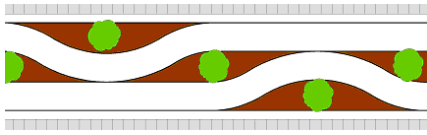
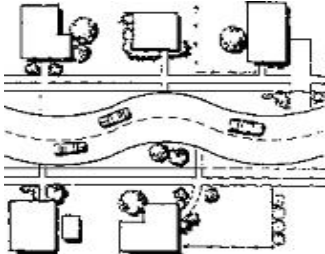
Most of the measures in the first three categories require physical changes to the street; whereas, most of the measures in the last category involve nonphysical changes such as signage, education, enforcement, speed monitoring trailers, and signal timing.

Additionally, State law provides the City with the authority to lower the speed limit of a residential street to 5 miles per hour below the the statutory speed required by the Oregon Department of Transportation.¹ The statutory speed for local streets is 25 miles per hour; therefore, the City can lower the speed limit on local streets to 20 miles per hour. Three criteria must be met to establish the ordinance, in addition to posting new speed limit signs:

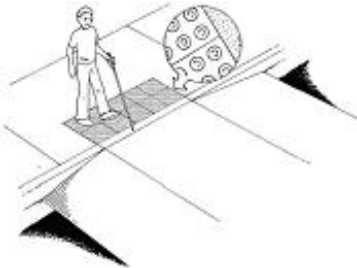
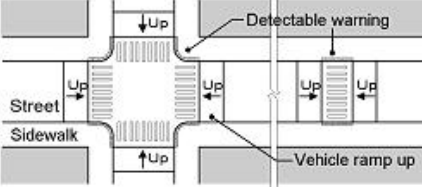
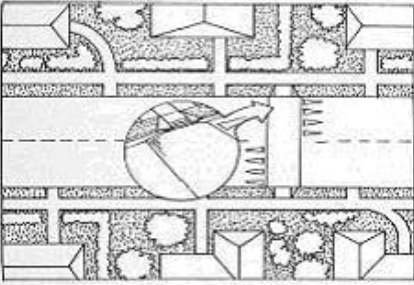
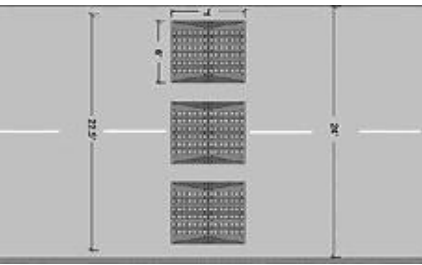
¹ ORS 810.180(10)

1. The street is located in a residential district.
2. The street has an average volume of fewer than 2,000 motor vehicles per day, more than 85% of which are traveling less than 30 miles per hour.
3. A traffic control device is used to indicate the presence of pedestrians and bicyclists.

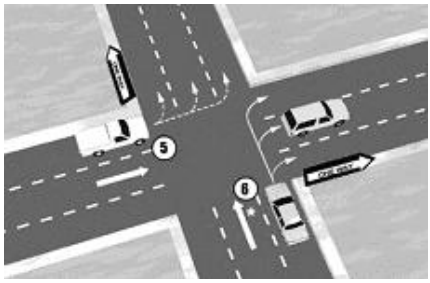
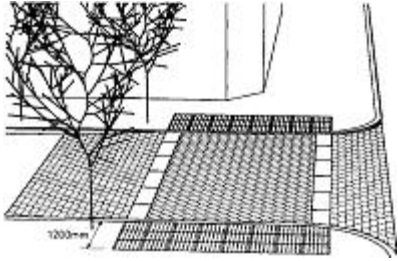

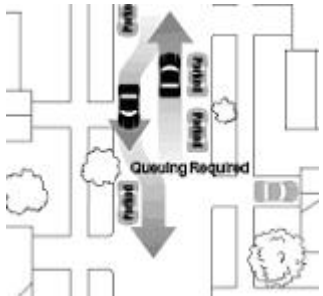
Table 11-1 Neighborhood Traffic Management (NTM) "Tool Box"





NTM Measure	Description	Example	Functional Classification				
			<input checked="" type="checkbox"/> Recommended <input type="checkbox"/> Optional <input type="checkbox"/> Not Recommended				
			Arterial	Collector	Neighborhood Route	Local Street	Skinny Street
Horizontal Deflection							
Bulbout	Curb extension at an intersection that reduces the pedestrian crossing distance by bringing the curb out into the parking lane. Reduces speeds and increases pedestrian safety by reducing crossing distance.		<input type="checkbox"/>	<input checked="" type="checkbox"/>	<input checked="" type="checkbox"/>	<input checked="" type="checkbox"/>	<input type="checkbox"/>
Choker	Midblock pedestrian or landscaped curb extension that narrows the roadway. Reduces speeds and, if designed for pedestrians, increases pedestrian safety by reducing crossing distance.		<input type="checkbox"/>	<input type="checkbox"/>	<input checked="" type="checkbox"/>	<input checked="" type="checkbox"/>	<input type="checkbox"/>
Chicane	Curb extensions or offsets along a portion of a roadway. Prevents drivers from taking a "straight shot" down the street, thereby reducing speeds.		<input type="checkbox"/>	<input checked="" type="checkbox"/>	<input checked="" type="checkbox"/>	<input checked="" type="checkbox"/>	<input type="checkbox"/>
Curvilinear Street	Similar to a chicane. A street with a series of 25 MPH reverse curves along its length. Prevents drivers from taking a "straight shot" down the street, thereby reducing speeds.		<input type="checkbox"/>	<input checked="" type="checkbox"/>	<input checked="" type="checkbox"/>	<input checked="" type="checkbox"/>	<input checked="" type="checkbox"/>

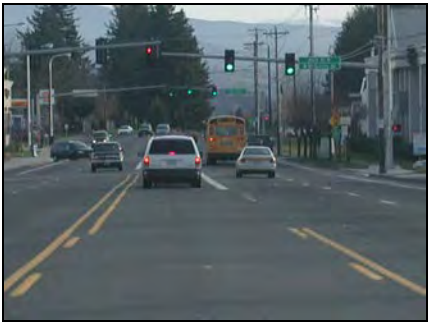




NTM Measure	Description	Example	<input checked="" type="checkbox"/> Recommended <input type="checkbox"/> Optional <input type="checkbox"/> Not Recommended				
			Functional Classification				
			Arterial	Collector	Neighborhood Route	Local Street	Skinny Street
Skippy Street	Street with narrower than normal travel lane widths. May involve overlap of parking and travel lanes. Reduces speeds and increases pedestrian safety by reducing crossing distance.		<input type="checkbox"/>	<input type="checkbox"/>	<input checked="" type="checkbox"/>	<input checked="" type="checkbox"/>	<input type="checkbox"/>
Center Median	Median in the middle of the roadway that narrows the adjacent travel lanes. Reduces speeds and increases pedestrian safety by providing a pedestrian refuge.		<input type="checkbox"/>	<input type="checkbox"/>	<input checked="" type="checkbox"/>	<input type="checkbox"/>	<input type="checkbox"/>
Traffic Circle	A round island in the middle of an intersection. Reduces vehicle speeds and collisions at intersections.		<input type="checkbox"/>	<input type="checkbox"/>	<input checked="" type="checkbox"/>	<input checked="" type="checkbox"/>	<input checked="" type="checkbox"/>
Offset Intersection Alignment	Intersection alignment that requires through traffic to jog left or right. Reduces speeds and cut-through traffic by providing a less direct path.		<input type="checkbox"/>	<input type="checkbox"/>	<input type="checkbox"/>	<input checked="" type="checkbox"/>	<input checked="" type="checkbox"/>



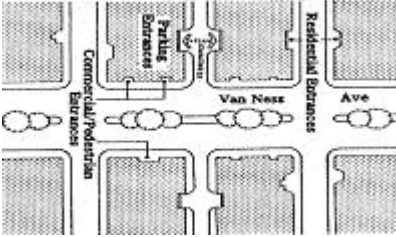

NTM Measure	Description	Example	<input checked="" type="checkbox"/> Recommended <input type="checkbox"/> Optional <input type="checkbox"/> Not Recommended				
			Functional Classification				
			Arterial	Collector	Neighborhood Route	Local Street	Skinny Street
Vertical Deflection							
Raised Crosswalk	Raised pavement surface at a crosswalk location. Reduces speeds and increases pedestrian safety by emphasizing the pedestrian crossing and eliminating the need for pedestrians to step down into the roadway.		<input type="checkbox"/>	<input type="checkbox"/>	<input checked="" type="checkbox"/>	<input checked="" type="checkbox"/>	<input checked="" type="checkbox"/>
Raised Intersection	Raised pavement surface throughout entire intersection area. Reduces speeds and increases pedestrian safety by emphasizing pedestrian crossings and eliminating the need for pedestrians to step down into the roadway.		<input type="checkbox"/>	<input type="checkbox"/>	<input checked="" type="checkbox"/>	<input checked="" type="checkbox"/>	<input checked="" type="checkbox"/>
Speed Hump/Table	Raised pavement surface across the entire width of a roadway. Humps are designed so that a vehicle's front and rear wheels travel over the hump at different times. Tables are longer than humps and accommodate a vehicle's front and rear wheels at the same time. Reduces vehicle speeds.		<input type="checkbox"/>	<input type="checkbox"/>	<input checked="" type="checkbox"/>	<input checked="" type="checkbox"/>	<input checked="" type="checkbox"/>
Speed Cushion	Similar to speed humps but not raised across the entire width of the roadway. Reduces vehicle speeds while allowing emergency vehicles to travel unimpeded due to their wider axles.		<input type="checkbox"/>	<input checked="" type="checkbox"/>	<input checked="" type="checkbox"/>	<input checked="" type="checkbox"/>	<input checked="" type="checkbox"/>

NTM Measure	Description	Example	<input checked="" type="checkbox"/> Recommended <input type="checkbox"/> Optional <input type="checkbox"/> Not Recommended				
			Functional Classification				
			Arterial	Collector	Neighborhood Route	Local Street	Skinny Street
Volume Control Measures							
Full/Partial Closure	The complete or partial closure of a roadway to all through traffic by means of a physical barrier. Pedestrian and emergency access usually allowed. Reduces cut-through traffic.		<input type="checkbox"/>	<input type="checkbox"/>	<input type="checkbox"/>	<input checked="" type="checkbox"/>	<input checked="" type="checkbox"/>
Center Median Barrier	Median in the middle of the roadway that separates vehicles traveling in opposite directions and restricts left-turn movements. Median may extend through an intersection so as to block through movements on cross streets. Prevents cut-through traffic and increases vehicular safety by reducing turning conflicts.		<input checked="" type="checkbox"/>	<input checked="" type="checkbox"/>	<input checked="" type="checkbox"/>	<input type="checkbox"/>	<input type="checkbox"/>
Diverter	A median or other barrier, such as a curb extension, that forces traffic to turn in a particular direction. Reduces cut-through traffic and decreases vehicular conflicts.		<input type="checkbox"/>	<input type="checkbox"/>	<input type="checkbox"/>	<input checked="" type="checkbox"/>	<input checked="" type="checkbox"/>

NTM Measure	Description	Example	<input checked="" type="checkbox"/> Recommended <input type="checkbox"/> Optional <input type="checkbox"/> Not Recommended				
			Functional Classification				
			Arterial	Collector	Neighborhood Route	Local Street	Skinny Street
One-way Street	A street that accommodates vehicular travel in only one direction. Reduces the number of available travel routes.		<input type="checkbox"/>	<input type="checkbox"/>	<input type="checkbox"/>	<input checked="" type="checkbox"/>	<input checked="" type="checkbox"/>
Other Elements							
Pavement Alternatives	Use of bricks or colored pavement to emphasize pedestrian crossing locations.		<input type="checkbox"/>	<input type="checkbox"/>	<input checked="" type="checkbox"/>	<input checked="" type="checkbox"/>	<input checked="" type="checkbox"/>
Entry Treatments	Use of landscaping to delineate and enhance a neighborhood entrance.		<input type="checkbox"/>	<input type="checkbox"/>	<input type="checkbox"/>	<input checked="" type="checkbox"/>	<input checked="" type="checkbox"/>
On-Street Parking	Use of parked cars to buffer pedestrians from moving vehicles and to reduce speeds, particularly on skinny streets where travel lanes and parking lanes overlap and must be shared by moving and parked vehicles.		<input type="checkbox"/>	<input type="checkbox"/>	<input type="checkbox"/>	<input checked="" type="checkbox"/>	<input checked="" type="checkbox"/>

NTM Measure	Description	Example	<input checked="" type="checkbox"/> Recommended <input type="checkbox"/> Optional <input type="checkbox"/> Not Recommended				
			Functional Classification				
			Arterial	Collector	Neighborhood Route	Local Street	Skinny Street
Informational Sign	Use of signs to alert drivers to various hazards.		<input type="checkbox"/>	<input type="checkbox"/>	<input checked="" type="checkbox"/>	<input checked="" type="checkbox"/>	<input checked="" type="checkbox"/>
Stop Sign	Use of stop signs to increase safety and interrupt traffic flow making routes less desirable for cut-through traffic. Typically placed at intersections. Warrants determined by the Manual on Uniform Traffic Control Devices (MUTCD). Not a speed control measure per MUTCD.		<input type="checkbox"/>	<input type="checkbox"/>	<input type="checkbox"/>	<input checked="" type="checkbox"/>	<input checked="" type="checkbox"/>
Truck Restrictions	Use of "No Truck" signs at key intersections to restrict through truck trips but not local truck trips.		<input type="checkbox"/>	<input type="checkbox"/>	<input type="checkbox"/>	<input checked="" type="checkbox"/>	<input checked="" type="checkbox"/>
Part Time Restrictions	Use of signs to limit through and/or turn movements during key times, typically during peak hours. Reduces cut-through traffic and facilitates traffic flow during peak hours.		<input checked="" type="checkbox"/>	<input checked="" type="checkbox"/>	<input checked="" type="checkbox"/>	<input type="checkbox"/>	<input type="checkbox"/>

NTM Measure	Description	Example	<input checked="" type="checkbox"/> Recommended <input type="checkbox"/> Optional <input type="checkbox"/> Not Recommended				
			Functional Classification				
			Arterial	Collector	Neighborhood Route	Local Street	Skinny Street
Signal Timing	Coordination of signals to reduce stops along corridors and delays at intersections. Reduced green time on side streets discourages cut-through travel.		<input checked="" type="checkbox"/>	<input checked="" type="checkbox"/>	<input type="checkbox"/>	<input type="checkbox"/>	<input type="checkbox"/>
Police Enforcement	Use of regulatory authority to cite violators for speeding and other traffic infractions, such as illegal turning movements, to reduce such violations in the future.		<input checked="" type="checkbox"/>	<input checked="" type="checkbox"/>	<input checked="" type="checkbox"/>	<input checked="" type="checkbox"/>	<input checked="" type="checkbox"/>
Education	Education of the public regarding the hazards of speeding and the impacts of cut-through traffic through public service announcements, direct mailings, and driver education courses.		<input checked="" type="checkbox"/>	<input checked="" type="checkbox"/>	<input checked="" type="checkbox"/>	<input checked="" type="checkbox"/>	<input checked="" type="checkbox"/>
Speed Reader Board	Use of speed reader board to measure and display a driver's speed.		<input checked="" type="checkbox"/>	<input checked="" type="checkbox"/>	<input checked="" type="checkbox"/>	<input checked="" type="checkbox"/>	<input checked="" type="checkbox"/>
Photo Radar Van	Use of photo radar van to measure a driver's speed and issue speeding tickets for violations.		<input checked="" type="checkbox"/>	<input checked="" type="checkbox"/>	<input checked="" type="checkbox"/>	<input checked="" type="checkbox"/>	<input checked="" type="checkbox"/>

NTM Measure	Description	Example	<input checked="" type="checkbox"/> Recommended <input type="checkbox"/> Optional <input type="checkbox"/> Not Recommended				
			Functional Classification				
			Arterial	Collector	Neighborhood Route	Local Street	Skinny Street
Neighborhood Speed Watch	Citizen-based traffic management program that allows citizens to identify speeders with speed measuring devices and send them a standardized letter regarding the hazards of speeding.		<input type="checkbox"/>	<input type="checkbox"/>	<input checked="" type="checkbox"/>	<input checked="" type="checkbox"/>	<input checked="" type="checkbox"/>
Shared Street	A street without curbs where bollards, chokers, and/or landscape elements define vehicle and pedestrian areas. Reduces speeds through shared use of roadway by all travel modes. Originated in Europe.		<input type="checkbox"/>	<input type="checkbox"/>	<input type="checkbox"/>	<input checked="" type="checkbox"/>	<input checked="" type="checkbox"/>
Short Blocks	Use of shorter blocks to create more intersections and more streets to distribute traffic. Closely spaced intersections reduce speeds and provide more potential locations for stop signs and signals.		<input type="checkbox"/>	<input type="checkbox"/>	<input type="checkbox"/>	<input checked="" type="checkbox"/>	<input checked="" type="checkbox"/>
Enhanced Major Street Performance	Provision of adequate capacity and connectivity on arterials and collectors to encourage longer trips on these facilities and to discourage cut-through trips on local streets and neighborhood routes.		<input checked="" type="checkbox"/>	<input checked="" type="checkbox"/>	<input type="checkbox"/>	<input type="checkbox"/>	<input type="checkbox"/>

IMPLEMENTATION

Successful neighborhood traffic management requires the following:

- A process that identifies, evaluates, and prioritizes traffic management needs.
- Citizen involvement in traffic management measure selection.
- Professional design that considers the safety of all users.
- Funding and implementation of prioritized needs.

The Milwaukie Public Safety Advisory Committee is responsible for administering the City's neighborhood traffic management program. This committee meets once a month and has addressed the enforcement and education aspects of neighborhood traffic management through both the Traffic Safety Program and the Walk Safely Milwaukie Program. Engineering staff assist this committee to improve neighborhood traffic management program coordination and to provide the technical expertise needed for evaluation and implementation of deflection and volume control traffic management measures.

The neighborhood traffic management program relies on citizens to identify neighborhood traffic concerns. This identification process, by its very nature, is reactive. However, the funding level and evaluation process will be deliberate and methodical to allow for equitable and efficient use of limited funds. Any Neighborhood District Association can develop a traffic management plan that identifies more specific issues or needs. The City will endeavor to allocate money each year to undertake selected neighborhood traffic management measures (see Table 11-2).

RECOMMENDATIONS

Figure 11-1 outlines the proposed neighborhood traffic management process for the City of Milwaukie. As shown in this figure, there are multiple points in the process for public input and involvement and a feedback loop at the end to monitor the success of neighborhood traffic management measures that have been implemented.

It is recommended that the City annually fund the neighborhood traffic management program so that prioritized needs are implemented over time. The Neighborhood Traffic Management Action Plan (see Table 11-2) does not identify specific projects, but it does show the level of funding the City aspires to commit to the neighborhood traffic management program for the duration of this plan. With regard to this funding, it is recommended that the City develop a process that ensures neighborhood traffic management funding is equitably distributed throughout the city.

Many of the policy recommendations contained in the Street Design chapter are applicable to neighborhood traffic management as well, the most relevant of which are summarized below.

- **Variety:** Allow for a wide variety of traffic management measures, as identified in this chapter's neighborhood traffic management "tool box."
- **Effectiveness:** Ensure that the chosen measure addresses the identified problem.
- **Landscaping:** Provide for landscaping wherever feasible and practicable.
- **Maintenance:** Consider maintenance needs and issues when designing traffic management measures and ensure long-term maintenance needs can be met.
- **Neighborhood Input:** Provide for neighborhood input when designing traffic management measures.

Figure 11-1 Neighborhood Traffic Management Process

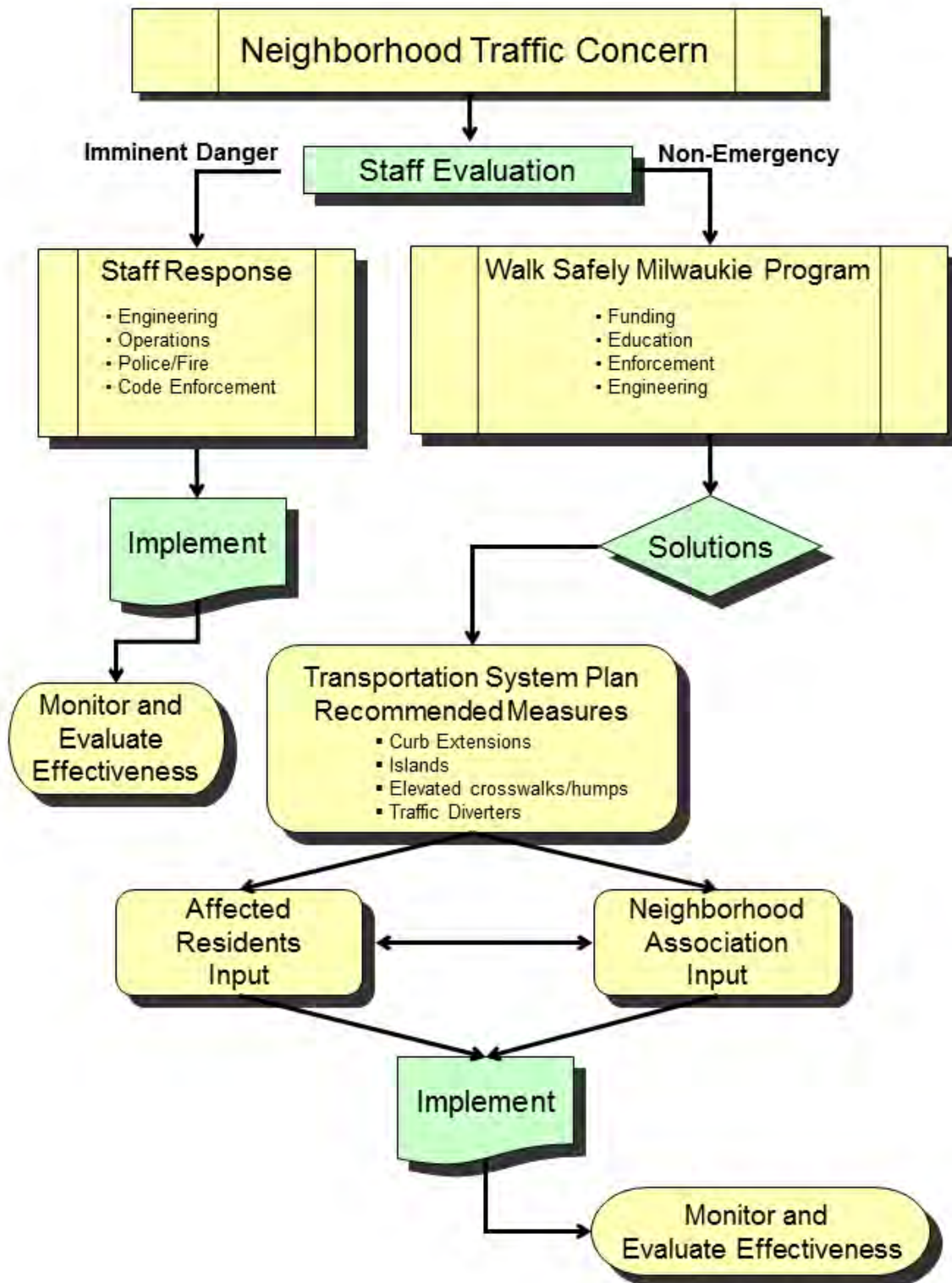


Table 11-2 Neighborhood Traffic Management Action Plan

Project Name	Project Description	From	To	Project Cost (\$1,000s ²)	Direct Funding or Grant Match
Walk Safely Milwaukie Program	Complete a few small traffic-calming and pedestrian safety projects throughout the city each year.	Citywide	Citywide	\$300 (\$13 annually) ³	Direct

² Project costs are order-of-magnitude estimates and are in 2012 dollars. Future costs may be more due to inflation.

³ Historically, the Neighborhood Pedestrian and Traffic Safety Program received \$13,000 annually. In more recent years, the program name changed to Walk Safely Milwaukie and funding was raised to \$100,000 annually. Future funding for the program will be evaluated on a biennial basis with the budget.

12

Downtown Parking



The purpose of this chapter is to describe the unique parking needs in Milwaukie, outline some strategies for improving how the City manages and regulates parking, and the policies by which the City will manage and develop parking. It also recommends specific actions the City and downtown businesses can take to both manage parking demand and transition downtown to a less auto-dependent environment. The focus of this chapter is downtown Milwaukie, which is defined as the area covered by the Downtown Zones, and is a subset of the regionally-designated Town Center. But the guiding principles and policies are also directly applicable to the Tacoma St and Park Ave areas, where stations for the new Portland-Milwaukie Light Rail (PMLR) will be constructed. Commuter parking at those station areas could impact the adjacent neighborhoods.

The role of parking in downtown is to support the realization of the *Downtown and Riverfront Land Use Framework Plan*, which envisions a lively downtown area that is a cultural and commercial center for the community, comprised of an exciting and attractive mix of uses and amenities. Additionally, downtown is projected to be the location of significant employment growth (see Chapter 4). People will come downtown to work and to experience an environment that is unique, active and diverse. As a general principle, people do not come downtown to park.

This chapter addresses the needs and strategies associated with several distinct types of parking users:

- Employees
- Commuters (or park-and-riders)
- Downtown residents
- Visitors/customers

TSP GOAL AND POLICY FRAMEWORK

As part of this TSP update, the community developed a set of goals to guide the development of the transportation system in Milwaukie (see Chapter 2). Several of these TSP Goals guide the City's policies on parking in downtown Milwaukie:

- **Goal 1 Livability** guides the City to address spillover parking into residential neighborhoods.

- **Goal 9 Economic Vitality** speaks to the importance of downtown as a hub of commerce and employment.
- **Goal 3 Travel Choices** directs the City to support travel options that allow individuals to reduce single-occupant vehicle trips.
- **Goal 6 Sustainability** calls for the City to decrease reliance on automobile transportation and increase the use of other modes to minimize transportation system impacts on the environment.
- **Goal 7 Efficient and Innovative Funding** directs the City to identify and develop diverse and stable funding sources to implement recommended projects in a timely fashion.

NEEDS

Parking needs in downtown Milwaukie can be divided into four categories: (1) improving enforcement and permitting practices, (2) managing parking supply as downtown surface lots redevelop and in light of the on-street spaces displaced by the new PMLR, (3) modifying code requirements for parking associated with new development, (4) and improving the parking facilities themselves.

Enforcement and Permitting Practices

Though the City has managed parking in downtown for many years, the projected growth of residential and mixed use redevelopment along the PMLR extension through downtown has revealed some distinct needs related to how the City allocates, permits, and enforces public parking.

It is common practice for many downtown employees to park in short-term on-street spaces and move their car from space to space throughout the day to avoid getting a parking ticket. The City's policy (in the Milwaukie Municipal Code) is to enforce against this type of activity (known as "moving-to-evade"), and, in 2009, revisions were made to the "Move-to-Evade" or "Block Rule" ordinance (Milwaukie Municipal Code Section 10.20.080) that allow the City's Code Compliance staff more latitude to cite people who move their cars between short-term spaces during the day.

In 2006, the City mapped all of the parking spaces in downtown Milwaukie and began a regular practice of monitoring parking inventory and permit use. Prior to 2006, without such data, the staff could not identify problems; therefore, for a long time there was no adjusting of time-limit spaces to meet adjacent purposes.

In 2008, the City created information for the public and downtown employees about location, cost, availability, and the purpose of downtown parking lot locations, as well means for utilizing the permit program. This information has been distributed through targeted outreach and direct mailings to downtown businesses, brochures, maps, and website development. In February 2013, the City's Finance Department took over administration of the parking permit program. This shift brings enhancements to the permit program, including selling permits in more than one location (e.g., at City Hall, by mail, on-line), offering flexible payment options (e.g. credit card, automatic deduction), and offering customized permit packages (e.g. monthly, semiannually, annual renewals).

The City has a Residential Parking Permit program, primarily designed for neighborhoods adjacent to the downtown core. An existing traffic regulation (No. 237, adopted in May 1993) provides a straightforward blueprint for defining area eligibility and the process to establish a

residential parking permit area. Within Traffic Regulation No. 237, Section 2 (Area Eligibility) sets forth the criteria to initiate the process of establishing a residential parking permit area.

To implement the Residential Parking Permit program, there are three areas that need further clarification from City Council: (1) establishing a fee structure, (2) determining which City department or division will enforce the residential parking permit area (e.g., police or code enforcement), and (3) establishing a penalty structure for violations within the permit area. Further policy development is needed to address the potential parking impacts of mixed use redevelopment in the downtown core. This includes guidance on how to address the parking needs of downtown residents and businesses, as well as what mechanisms need to be in place to address parking spillover.

Management of Future Parking Supply

With most of downtown's buildable land already in use as surface parking, future development will inevitably impact net parking resources. PMLR construction will result in the loss of approximately 50 on-street parking spaces near the new light rail station downtown. While the overall amount of public and private parking is generally abundant today, it will become less so over time.¹

One of the first needs addressed in this TSP update is the sorting out of who is responsible for providing future parking in downtown Milwaukie. The answer depends on several factors: whether the parking is public or private; is replacing existing parking or serving new uses; is intended for downtown employees, residents, or visitors; and is part of a structure or surface lot. This chapter attempts to clarify how these factors should be considered as the City determines its parking-related responsibilities associated with Downtown Plan implementation.

As evidenced by the North Main Village project, which was built on a former Safeway site near the corner of Main St and Harrison St, new development and infill in downtown Milwaukie will cause existing surface parking facilities to transition to new and denser land uses. The City should take a role as a developer or facilitator of new parking supply if it hopes to accomplish the urban vision outlined in the Downtown Plan. The private sector must also participate in the provision of new parking, and the City should understand how and when it could support businesses in this regard.

Development Code Modifications

The City Zoning Ordinance regulates not only building form and use, but also the amount of parking that can and should be built on a site. With the exception of the Downtown Storefront Zone, the City's parking requirements for downtown development are currently the same as for other sites outside of downtown that are zoned for commercial or office development. The City's current parking standards for new development within the downtown zones are exceedingly variant and in many cases, overly burdensome. The parking requirements can be summarized as follows:

- In the Downtown Storefront Zone (and in the part of the Downtown Office Zone that is north of Washington St and east of McLoughlin Blvd), no off-street parking is required. Parking is allowed, but the applicant determines how much to provide.

¹ As described in Chapter 3, the City's December 2012 downtown parking inventory found 1,828 parking spaces (385 on-street and 1,443 off-street). Of these, 1,221 are private parking spaces. During the peak hour (11:00 a.m.-12:00 p.m.), the public spaces are generally 50% full and the private spaces are 42% full. See Figure 3-18 in Chapter 3 for a map of parking in downtown.

- In the other Downtown zones, off-street parking is required. The type of use determines the amount required.² Applicants are required to provide between 1 and 4 spaces per 1000 sq ft of retail, restaurant, or office area; and between 1 and 1.25 spaces per unit of multifamily residential development.

Currently, the actual demand for downtown parking is fairly evenly distributed between different land uses (e.g. retail, office, and restaurants).³ This pattern of parking demand does reflect the multiple parking standards currently in place in the City Zoning Ordinance, which suggests that specific uses demand specific allocations of parking. A parking utilization study conducted in 2012 indicated that the demand for parking in downtown Milwaukie averaged 2.3 spaces per 1,000 gross sq ft.

The parking requirements that are currently in place may in fact require that a new development provide more parking than is needed by the development. On the relatively small building sites in downtown, such excessive requirements may preclude development altogether due to the high cost of building structured parking.

Parking Facility Improvements

Most of the downtown parking supply is located on private surface lots outside of the downtown core (Main St between Scott St and Washington St). In many cases, the lots have inadequate signage, lighting, landscaping, and surface treatments. This is equally true for many of the public lots as well. The poor quality of the existing parking lots limits the ability of the City and the private sector to maximize the use of the existing inventory. Without high quality lighting, attractive physical appearance (i.e., paving, signage, landscaping), and pedestrian connectivity, the underutilization of existing spaces will continue to fuel the perception that there is a shortage of downtown parking.⁴

The issue of pedestrian connectivity should be emphasized. The decision to park in a lot is comprised both of the assessment of the lot condition and the experience of walking to and from that lot. Without a safe, attractive, and convenient sidewalk system that connects all lots to all downtown destinations, the City will miss serving a certain percentage of would-be permit parkers who elect not to participate because of perceived safety issues. In Milwaukie, which has a complete sidewalk system downtown (see Figure 3-2 in Chapter 3), the need leans more toward safety than convenience. For example, many downtown sidewalks are not well lit, and many lack pedestrian amenities like street trees, benches, and trash cans.

STRATEGIES

There are two strategies for addressing the needs described above. The first is to adopt and implement a set of Downtown Parking Guiding Principles or Parking Management Principles, which establish a policy framework for the City's decision-making on downtown parking-related issues. The second strategy is to adopt and implement a set of Parking Operating Principles, which will direct City staff or its representatives in the day-to-day operation of the parking system.

As the City is not yet prepared to abide by these principles, a set of recommendations is included in the next section of this chapter. These recommendations will enable the City to effectively transition from its current practices to those described in the two sets of principles.

² The parking requirements vary across approximately 59 use categories. See Milwaukie Municipal Code 19.600.

³ See Table 3-11 in Chapter 3.

⁴ Private lots are not currently utilized for public parking, but shared use arrangements are recommended and the physical state of the private lot will affect its marketability to potential users.

Downtown Parking Guiding Principles (Parking Management Principles)

"Guiding Principles for Managing Downtown Parking" were initially developed in 2003 as part of the *Downtown Milwaukee Downtown Parking and Traffic Management Plan*, and were confirmed and updated during the 2007 TSP update process. Although the 2003 set of Guiding Principles provides a relatively comprehensive framework for managing downtown parking, the 2007 TSP update refined the Principles and filled in a few gaps. For example, the 2003 version did not address downtown residential parking, nor were the principles regarding downtown park-and-rides sufficiently refined. The following 23 principles describe a complete and state-of-the-industry set of principles for managing parking in downtown Milwaukee:

Customer/Client/Vendor/Visitor Parking

1. The most convenient parking spaces should be reserved to support customer/client/vendor/visitor access to downtown. Management of the on-street parking system should promote customer/visitor accessibility by prioritizing the parking of short-term patrons in downtown Milwaukee.
2. The City of Milwaukee should take the lead role in providing sufficient short-term parking to support the retail environment described in the *Downtown Plan*. The on-street system is therefore not intended for employee, resident, or commuter parking during normal business hours.
3. On-street parking in the downtown core should support street level activities. The provision of on-street parking on Main St should not be sacrificed for street capacity enhancement or vehicular through-put.
4. The City should enforce against long-term parkers (typically employees) who move their vehicles during the day to evade being cited for parking in short-term spaces.

Multimodal Access

5. The City should strive to implement downtown travel options to provide a balanced system that includes public transit, automobile, bicycle, and pedestrian facilities and services for all downtown users.
6. Parking management strategies and programs should support, complement, and consider the availability and use of all access modes.

Employee Parking

7. City-controlled off-street lots should be managed to meet use demand using the 85 Percent Full Standard (85 PFS).⁵ All parking lot management strategies should be coordinated with transportation demand management objectives to ensure that employees and customers have reasonable options for access.
8. Whether in on-street subareas or in off-street lots, wherever parking exceeds the 85 PFS, employee parking should be eliminated/phased out first. This is so the City can accommodate visitors and customers at all times. Businesses that have designated private employee parking lots should be encouraged to do the same, wherever possible. The City should help businesses understand and utilize demand management strategies to help employees transition to alternative modes of travel over time.

⁵ Refer to page 12-7 for an explanation of the 85 Percent Full Standard.

9. The City should provide clear and consistent information about downtown parking to optimize utility and convenience for all users.
10. The City should support downtown business efforts in transitioning more downtown employees into alternative modes (i.e., transit, bike, walk, ride-share) through business-based programs and incentives.

Park-and-Ride/Public Transit

11. Providing parking for downtown customers, visitors, and employees is a higher priority than providing parking for commuters destined for other cities.
12. Park-and-ride lots should be located outside the downtown core.
13. Bus staging in the downtown should have minimal impact to on-street visitor parking. Buses should serve downtown, but should not stage on downtown streets. The purpose and priority for transit stops in the downtown area is to provide safe, convenient, business-friendly access for downtown users, customers, and employees.
14. While transit park-and-ride structures are discouraged downtown, the City may allow for the provision of such a structure should it dedicate some spaces for downtown parking and lead to future control/ownership of the facility by the City for public parking exclusively or predominantly.

Quality of Parking

15. All downtown parking, whether public or private, should be safe, secure, well lit, and maintained to enhance the users' sense of safety and security.

Residential Parking

16. The downtown parking supply should be managed to minimize parking impacts on adjacent residential neighborhoods.
17. Downtown residential development should be responsible for providing on-site parking, or negotiating parking availability in off-street lots, for new residential units.

Publicly Managed Parking

18. Over time, the City anticipates that its off-street lots will redevelop and City-owned or -leased surface parking lots will gradually disappear. The City will attempt to continue to accommodate the commercial and residential buildings whose tenants are, as of November 2013, making use of City off-street lots. The City will continue this practice as long as public off-street spaces are available.⁶
19. Downtown Milwaukie employees are the highest priority customers in the City's parking permit program. As the permit system approaches capacity (i.e., spaces become unavailable for new applicants), the City should revoke parking permits issued to commuters as necessary, and refrain from issuing new permits to commuters.
20. The City supports the provision of a structured public parking facility for visitor and employee parking. Due to the expense of structured parking and the benefit structured parking would provide to downtown businesses, the City should commence planning for

⁶ The term "City lots" in this recommendation excludes the lots adjacent to the Ledding Library and City Hall.

structured parking only in collaboration with the downtown business community and only after a viable funding strategy is identified.

21. The City supports shared use of parking areas, including public lots, when there is no conflict in operating hours.

Parking Requirements for New Development

22. Parking requirements for new development should contain needed parking on-site or through shared parking agreements.
23. New parking supply should be located within structures that contribute to the design and activity of downtown whenever possible.

Parking Operating Principles

Parking Operating Principles define the day-to-day operating priorities for managing parking in the Downtown Zones. The Operating Principles provide specific direction for addressing issues that will occur in the system, which should assist the City in following the Guiding Principles.

85 Percent Full Standard (85 PFS)

The first and most important piece of the Operating Principles is the 85 Percent Full Standard (85 PFS), and is therefore discussed separately here. The 85 PFS is an industry-based management standard for understanding the sufficiency of parking supply in a specified and limited area. The standard establishes a rule for when to make on-the-ground adjustments: when parking spaces in specified and limited areas are routinely 85% full during the peak hour, the City should implement a more aggressive strategy to assist priority users in finding parking.⁷

Because downtown Milwaukie is relatively small, the 85 PFS should be applied beyond a "hot-spot" basis. That is, as small areas of downtown redevelop or become more popular, consideration should be given to parking utilization beyond the immediate parking impact area. Nearby parking utilization should also be considered, due to the compactness of downtown and the Downtown Plan's emphasis on high quality pedestrian amenities and walkability.

However, when the 85 PFS is reached, there are many Operating Principles the City can apply in electing how to respond. These are described below, and are followed by the rest of the Operating Principles.

- **At 85 PFS:** Work with downtown employers to advertise and inform employees about how to use the City permit system and where parking is available.
- **At 85 PFS:** Enforce against employees or TriMet patrons who use spaces intended for visitors to downtown businesses.
- **At 85 PFS:** Modify the availability of on-street parking for short-term visitors or long-term permit holders, depending on the need of the adjacent building occupants.
- **At 85 PFS:** Increase permit prices.

⁷ One possible consequence could be that no strategies need to be implemented if the utilization level is deemed acceptable. However, the trigger provides a proactive system of review and provides time to implement parking management strategies before overly constrained conditions occur.

- **At 85 PFS:** Invest in lighting, landscaping, and other amenities to make other parking areas, and the walk to them, more attractive.
- **At 85 PFS:** Acquire or construct new parking supply.
- **At 85 PFS:** Work with employers and TriMet to decrease the need for downtown employees' and patrons' need to drive to and park in downtown (implement Transportation Demand Management measures).

Additional Operating Principles are as follows:

- Short-term parking is defined as parking with time-stays less than or equal to four hours.
- Parking management may include strategies for modified pricing levels for short- and long-term parking, user types, or lot locations.
- The City will manage on-street parking spaces to primarily serve the ground-floor use of adjacent properties.
- There will be no unregulated on-street parking in downtown zones.
- As long as spaces are available, off-street parking in downtown will be operated for the benefit of visitors, employees, and residents of downtown Milwaukee.
- Residential use of public off-street parking lots will be limited to nonbusiness hours (nights and weekends in some locations).
- Over time, public off-street parking will be transitioned to serve a higher mix of short-term visitor parking demand. Alternative mode options will be developed to support this transition.
- Except where residential parking permit zones are established, on-street parking outside of the downtown zones (i.e., in adjacent residential areas) will be unregulated but enforced by complaint only.
- If parking spillover from the downtown zones, or from the future light rail station areas (at Tacoma St and Park Ave), results in inadequate parking availability in the neighborhoods adjacent to these areas, the City will facilitate the establishment of residential parking permit zone programs upon the request and support of the affected neighborhood(s).⁸

The application of both the Guiding Principles (Management Principles) and the Operating Principles will result in a parking distribution pattern that places each parking user in the location that best supports the goals of the Downtown Plan. As illustrated in Figure 12-1, visitor parking is provided in the retail core, employees are directed to public lots, park-and-ride commuters are moved to the downtown fringe, and residential neighborhoods are protected from spillover effects.

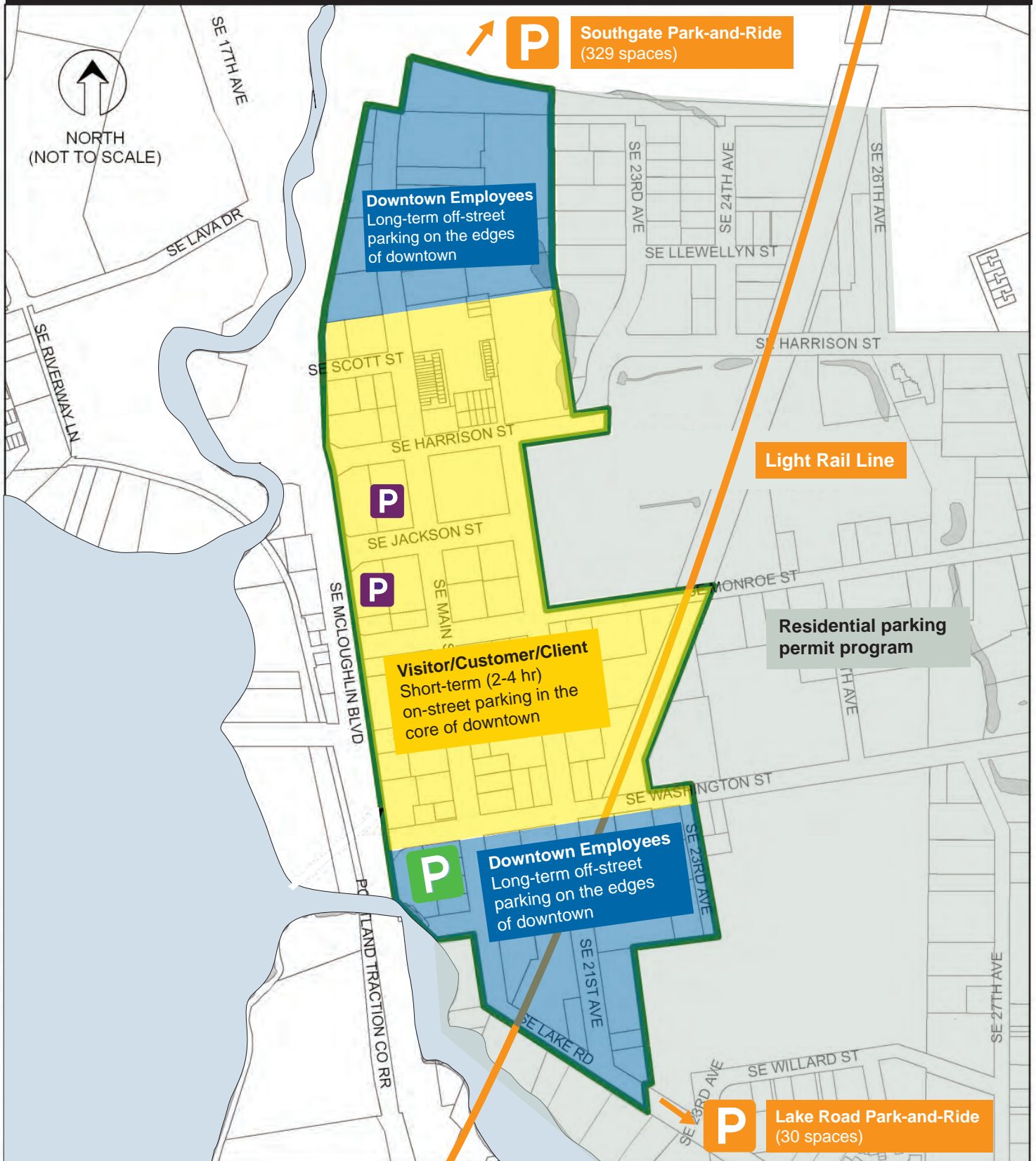
The goal is a clear and predictable downtown parking system, as summarized in Table 12-1. The Guiding Principles account for each of the different types of parking users and the three types of parking spaces potentially available to them. Additionally, Transportation Demand Management Tools are diligently designed into the parking management system, varying slightly depending on the user type.

⁸ See recommendation on page 12-12 for detail.

Figure 12-1 | Diagram of Parking Type Locations

Downtown Milwaukie

November 2013



P Existing Park-and-Ride

P Potential Future Parking Structure

P Existing long-term parking by permit
Subject to land and funding availability

Table 12-1 Parking Facility Priorities by Parking User Type

Parking User Types	Parking Facility Type			Transportation Demand Management Tools
	On-Street Parking	Off-Street Public Parking	Off-Street Private Parking	
Visitor/Customer/Client	Priority	Allowed	Allowed	<ul style="list-style-type: none"> • Transit • Bike parking • Pedestrian access and amenities
	2-hr and 4-hr parking	Subject to land and funding availability	On-site parking controlled by property owner	
Downtown Employees	Limited	Priority	Allowed	<ul style="list-style-type: none"> • Transit passes • Bike parking • Encourage carpooling • Flexible parking permit options
	<ul style="list-style-type: none"> • When not needed for adjacent retail/restaurant • By permit only • Subject to 85% rule 	<ul style="list-style-type: none"> • Subject to land and funding availability • Priority to occupants of buildings existing in 2007 • Locations may shift over time as downtown develops • Subject to 85% rule 	<ul style="list-style-type: none"> • On-site parking controlled by property owner • Shared parking arrangements encouraged • Private paid parking lots are allowed • New office/commercial development required to supply 0-2.5 spaces/1,000 sf⁹ 	
Downtown Residents	Limited	Limited	Allowed	<ul style="list-style-type: none"> • Transit passes • Bike parking • Car-sharing • More services in downtown, requiring fewer trips to destinations outside downtown
	<ul style="list-style-type: none"> • After hours only 	<ul style="list-style-type: none"> • After hours only 	<ul style="list-style-type: none"> • On-site parking controlled by property owner • Shared parking arrangements encouraged • Private paid parking lots are allowed • New residential development required to supply parking 	
Park-and-Ride (to Portland)	Not Allowed	Limited	Allowed	<ul style="list-style-type: none"> • Southgate park-and-ride (opened 2010)¹⁰ • Lake Rd park-and-ride (existing) • Improve E-W bus connections to downtown Milwaukie
		<ul style="list-style-type: none"> • Restricted in the core downtown area • Conditionally allowed in a parking structure • Must support downtown activity over the long term 	<ul style="list-style-type: none"> • On-site parking controlled by property owner 	

⁹ Downtown parking required for new development will be analyzed and potentially revised during the 2013-14 "Moving Forward Milwaukie" project.

¹⁰ The future of the Southgate park-and-ride is unclear once the PMLR opens in 2015. The City prefers that the Southgate site transition into operation as a parking lot for local employees.

RECOMMENDATIONS

The City should move to apply the Guiding Principles and Operating Principles. This will be easier to do with the implementation of certain policy recommendations, operational improvements, and capital projects.

Policy Recommendations

Adopt new parking development standards for commercial development in the downtown zones.

Amendments should create a unified parking standard for downtown commercial and office uses that does not require more parking spaces than are needed. The revised code should encourage shared parking agreements and acknowledge on-street parking as a resource for downtown businesses.¹¹

- Amend the Code to eliminate minimum parking ratios for commercial/retail uses in Downtown zones. This will enable the market to determine minimum parking levels for new commercial development, meaning that the City will allow new office and retail to be built in downtown Milwaukie without attendant parking (which supports the Downtown Plan's emphasis on the use of precious urban space for people and activity and not parking lots).
- Amend the Code to establish maximum surface lot parking ratios of 2.5 spaces per 1,000 sq ft for all commercial uses within the downtown zones (which would cover office, retail, personal service, restaurant, auto, government, bowling, church, fraternal organization, gym, and funeral home uses, which are each listed separately in the current code). This will prohibit development that requires large surface parking lots, supporting the Downtown Plan's emphasis on a compact and interesting urban environment.

Maximum parking ratios for parking provided in structured spaces are not recommended if they meet the City's development standards and design guidelines.

Adopt new parking development standards for residential development in the downtown zones.¹¹

Given that the on-street system in downtown is prioritized for customer/visitor use, the vision to bring greater levels of new residential development (over retail) to downtown will create potential conflicts for access to on-street parking. To mitigate this and assure that residential parking is available in downtown and on-street parking remains available to customers and visitors, the City should amend the Code as follows:

- Require no maximum parking allotment within structured parking facilities.
- To accommodate residential development that cannot incorporate parking into development sites (i.e., for reasons of site size, geometries, etc.), allow for requirement exceptions through approval of a transportation management and trip reduction plan.
- Prohibit the creation of residential on-street parking permit programs within the Downtown Zones.

¹¹ Downtown parking required for new development will be analyzed and potentially revised during the 2013-14 Moving Forward Milwaukie: Enhancing Our Commercial Districts project.

Adopt an action plan to fully implement the Residential Parking Permit program by 2015.

As the new PMLR begins to affect the City's core and the neighborhoods near PMLR station areas at Tacoma St and Park Ave, and as land uses intensify, conflicts for parking in adjacent residential neighborhoods will likely occur as downtown users begin to spill over in the residential areas. In response, it is recommended that the City develop and enact an action plan to fully implement a Residential Parking Permit Zone program.

Operational Projects

Public Information and Marketing

- Continue to distribute information to the public and downtown employees about location, cost, availability, and the purpose of downtown parking lot locations, as well means for utilizing the permit program. This can be accomplished through such efforts as targeted outreach to downtown businesses, mailings, brochures, maps, and website development.
- Create a transportation information package for downtown employees, to include public parking, transit, and biking information.
- Promote Metro's online tool, "Drive less. *Connect*," (through the Regional Travel Options program) that promotes a ride-matching service connecting carpoolers and bike buddies. Since its launch in 2011, commuters have avoided using approximately 50,000 gallons of gasoline and saved roughly \$308,000 collectively by joining carpools, biking, and riding transit.

Active Parking Management

The City should dedicate appropriate resources for actively managing downtown and station-area parking and the ripple effects into adjacent neighborhoods. This will include tools and staffing to enforce on-street parking time limits, maintain the downtown parking inventory map, and continue coordination between City departments. Active management further entails working with constituent groups (e.g. business owners, residents, and employees) to educate them about City policies and build their capacity to utilize alternative delivery models and modes, such as the formation of a Transportation Management Association and use of regional ride-share modalities.

Improve Parking Permit Program

Improvements to the City's Parking Permit Program can increase the use of off-street spaces that are currently underutilized. By moving employees who currently park on-street into off-street lots, valuable on-street spaces can be freed up for customer or visitor use.

Implement "Tiered Pricing"

Currently the City charges the same amount for all parking lots. As such, parking is not priced according to demand or proximity to "premier" destinations. Tiered pricing would set rates based on lot popularity. For example, a lot with occupancies over 85% would be priced higher than lots with significantly lower rates of utilization. Lots on the fringe of the downtown would be priced lower than more popular lots located in the core retail area.

Parking Utilization Monitoring Program

No less than every two years, City staff should count the parking supply and peak-hour parking utilization. With the results of this information, the Parking Manager or designated staff should

convene a meeting of stakeholders to review the results, check areas against the 85 PFS, and evaluate the need for any actions (e.g., redesignating short-term or long-term parking, modifying short-term parking durations, or adjusting the allotment of permits for Portland-bound commuters).

Identify Locations for Future Public Supply

As City-owned parking lots transition to more dense land uses, the City should continually consider the prospects for new parking supply for downtown employees.

Engage Owners of Private Parking Facilities to Provide Shared Parking

City staff should initiate a program to develop shared use agreements with owners of off-street private parking. The agreements should be developed for both employee parking and special event parking. The City or a downtown business association can take the lead in contacting property owners or developing incentives such as facility upgrades (e.g., lighting, striping, pavement, landscaping), leasing arrangements, revenue sharing, or public purchasing. Shared parking arrangements could be arranged between two private parties, or between private parties and the City.

Evaluate Funding Strategies for New Supply

The City should begin to discuss and evaluate potential funding sources for future public parking supply. These discussions with downtown stakeholders should assure that the final recommendations have broad support within the downtown community. Most public parking facilities developed in other jurisdictions are funded with multiple sources that include urban renewal/tax increment financing, parking fees and charges, meter districts, local improvement districts, capital fund allocations, and bonding.

Capital Implementation Projects

Signage Changes

Over time, distinctive, friendly, and clear customer/visitor parking signs should be designed and installed at all short-term public parking lots. The signs should be "blade" signs with information on both sides so that downtown patrons can read the signs from either direction.

Upgrade Public Parking Lots

The City should maintain the pavement, lighting, and landscaping of its off-street public parking facilities to ensure a safe and attractive appearance.

Implement the Public Area Requirements

Implementing the Public Area Requirements of the Downtown Plan will result in wider, continuous sidewalks with appropriate lighting. These improvements will help address concerns about walking several blocks between a parking lot and a destination.

Master Plan

Table 12-2, the Downtown Parking Master Plan Projects, summarizes the key projects needed to implement the recommendations in this chapter. Many of the projects related to the operation

and maintenance of the City's parking program may be self-funding through parking permit fees and parking fines.¹²

Table 12-2 Downtown Parking Master Plan Projects

Priority	Type	Project Name	Project Description	Cost(s) \$1,000s ¹³
High	O	Downtown Parking Management	Implement a downtown parking management system, including a dedicated parking manager.	\$40
High	C	Downtown Parking Signage	Install wayfinding and identification signage at McLoughlin Blvd intersections and around public parking lots.	\$10
High	C	Public Parking Structure	Construct 3- to 4-story public parking structure with retail at ground floor for visitor/employee parking.	\$11,000
Med	C	Downtown Streetscape Improvements	Install sidewalk bulbouts, lighting, and pedestrian amenities.	\$7,300
Med	C	Downtown Public Parking Lot Improvements	Upgrade and maintain off-street public parking facilities with improved landscaping and lighting.	\$60

Notes:

C = Capital Project High = High priority
 O = Operational Project Med = Medium priority
 P = Policy Project Low = Low priority

Action Plan

The Downtown Parking Action Plan (Table 12-3) identifies the highest priority projects that are reasonably expected to be funded with local funds by 2035, which meets the requirements of the State's Transportation Planning Rule.¹⁴ The action plan project list is based upon a 2007 citywide project ranking process. In 2007, all of the modal master plan projects were ranked by the TSP Advisory Committee after consideration of the Working Groups' priorities, other public support for the project, and how well each project implements the TSP goals and policies. For the 2013 TSP Update, City staff reassessed the prioritization of all projects, incorporating public comments gathered at and around a public meeting in June 2013. Action plan projects that were completed since 2007 were removed from the action plan and new projects identified as top priorities were added.

Table 12-3 Downtown Parking Action Plan

Project Name	Project Description	From	To	Project Cost (\$1,000s)	Direct Funding or Grant Match
Downtown Parking Management	Implement a downtown parking management system, including a dedicated parking manager.	Downtown	Downtown	\$40	Direct
Downtown Parking Signage	Install wayfinding and identification signage at McLoughlin Blvd intersections and around public parking lots.	Downtown	Downtown	\$10	Direct

¹² This source of funding is not included in the TSP transportation funding forecast (Chapter 13).

¹³ Project costs are order-of-magnitude estimates and are in 2012 dollars. Future costs may be more due to inflation. In the case of operational projects, estimated costs are for the entire 22-year planning period.

¹⁴ OAR Chapter 660, Department of Land Conservation and Development, Division 012, Transportation Planning, adopted on March 15, 2005, effective April 2005.

13

Funding and Implementation Plan

The purpose of this chapter is to describe the funding framework for considering City of Milwaukie transportation improvements between 2013 and 2035. This chapter outlines the foreseeable funding sources—and their restrictions—for both capital improvements and transportation maintenance projects. This chapter also provides a brief overview of additional funding sources.

CURRENT FUNDING SOURCES

The City of Milwaukie relies on a variety of funding sources for maintaining and improving its transportation infrastructure. Most of these sources are constrained, meaning that they can only be used for a specific function like expanding the system's capacity, paving the streets, or building bicycle facilities. The funds also flow into Milwaukie from a variety of sources, most of which are tax-based and administered through different levels of government and through different mechanisms.

Types of Transportation Funding Sources

The City has identified 10 transportation funding sources that are currently available:¹

Grant/Competitive Programs

- **Metropolitan Transportation Improvement Program (MTIP)** identifies how all federal transportation money is to be spent in the region in two-year increments. Each time the MTIP is developed, Milwaukie competes with other jurisdictions in the region for federal "regional flexible funds" that can be used for most aspects of the local transportation system.
- **Statewide Transportation Improvement Program (STIP)** is ODOT's project funding and scheduling document. The STIP makes funds available to cities, through a highly competitive process, for expansion, preservation, safety, and other system enhancements. The STIP makes expenditures from both State revenues and some federal programs.

City Share of State Highway Trust Fund

A portion of the taxes and fees assessed on Oregon motorists and freight haulers is paid to the City annually on a per capita basis. The primary sources are the State motor vehicle fuel tax, a

¹ This list includes federal funds that are not part of the City's regular revenue stream for transportation improvements.

weight-mile charge on heavy trucks, and vehicle registration fees. ODOT requires that cities set aside 1.0% of the local share of Highway Trust Fund proceeds for the construction and maintenance of bicycle facilities.

Local Funds—Fees and Taxes

- **Franchise Fees** are paid by each of the City-owned facilities—water, wastewater, and stormwater—to the City's Street Fund for their use of the public right-of-way. The utilities are able to pay the franchise fee with some of the revenue they collect from Milwaukie utility rate-payers.
- **PGE Privilege Tax** is similar to the franchise fees, in that Portland General Electric pays the City for its use of the public right-of-way. As part of the City's Street Surface Maintenance Program, a portion of this fee is dedicated to surface maintenance for the city's most important streets.
- **Local Gas Tax** is separate and apart from the State gasoline tax. Milwaukie gas stations pay a tax on fuel sold in Milwaukie, which is sent to the City for street maintenance use only.
- **Street Surface Maintenance Fee** is similar to a utility bill, in that all Milwaukie properties are charged a monthly fee for use of the street system. These fees are dedicated for street maintenance use only.
- **Local Improvement Districts (LIDs)** are special assessment districts in which property owners benefiting from a transportation improvement pay for that improvement. These have not been frequently used by the City, but are available to interested property owners.

Local Funds—Development Contributions

- **System Development Charges** are collected from developers when new construction is expected to place heightened demand on the transportation system. The vast majority of these monies can only be used by the City for adding capacity to the system.
- **Fee In Lieu of Construction** is collected when required street frontage improvements, typically associated with residential construction, are impractical to build. These funds are limited in both how and where they can be spent.

Details About Specific Funding Sources

The following section provides additional detail about most of these sources, particularly those that the City can rely on regularly. The regular revenue stream projection provides the baseline for the Funding and Implementation Plan in this TSP.

Most of these funding sources can be (and have been) used by the City to leverage one another and additional sources. As transportation improvements are expensive and the competition for transportation dollars is fierce, the City must utilize the funds it regularly receives as "match" for larger awards, which are typically available through federal grant programs. The complete transportation funding picture for the City therefore requires that regular revenues cover maintenance, operations, small projects, and matches for larger capital projects that the City cannot accomplish without an infusion of funds for the specified project. The Funding and Implementation Plan follows this premise throughout.

System Development Charges and Fee in Lieu of Construction

A transportation System Development Charge (SDC) is collected from developers when new construction or redevelopment is expected to place new demands on the transportation system.

The SDC charge is based on a study-based rate and the number of new vehicle trips the development is expected to generate. The City's current SDC rate is \$1,676 per new p.m.-peak-hour trip. The transportation SDC consists of a reimbursement charge and an improvement charge. The improvement charge portion is roughly 95% of the total SDC and can only be used to construct transportation projects that add capacity.

Fee in Lieu of Construction (FILOC) is collected from developers in lieu of construction when required frontage improvements would not be practical, efficient, or beneficial to construct. For example, constructing an isolated sidewalk in the middle of a residential block where no sidewalks currently exist has minimal impact. However, pooling fees collected in lieu of required frontage construction enables the City to build improvements where they are most needed in the neighborhood in which they were collected, such as along identified bikeways, walkways, or school routes.

SDC and FILOC revenue varies based on the level of new development, so it is difficult to accurately forecast the amount of money that will be available from these sources. For example, over the past three fiscal years, SDC and FILOC revenue has been lower than in previous periods, averaging only approximately \$11,100 per year (in 2012 dollars). Based on an assumption that the easing of the recent national recession and the opening of the new light rail line in 2015 will result in at least a slight increase in development activity in the future, the projected revenue from SDCs and FILOC over the next 22 years is estimated to be \$745,600, with \$444,500 already in hand from past FILOC collections, for a total of nearly \$1.2 million.

Franchise Fees

Each of the three City-owned public utilities—water, wastewater, and stormwater—pays 8% of its net revenue to the Street Fund for the use of the public right-of-way. For the fiscal year 2011/2012, the Street Fund received \$448,000 from such franchise fees. Franchise Fee projected revenue is expected to provide \$23.7 million over the next 22 years and is not restricted to either capital or maintenance projects.

State Gas Tax and Vehicle License Fees

The State of Oregon collects taxes and fees on motor vehicle fuel, licenses, and permits and then deposits the proceeds into the Highway Trust Fund. A portion of this fund is paid to cities annually on a per capita basis. By statute, the money may be used only for road-related purposes. Like most Oregon cities, Milwaukie uses its share primarily for street department operations and associated maintenance activities. Road maintenance includes a variety of activities such as striping, signage, sweeping, and shoulder maintenance.

Oregon motor vehicle fuel taxes are collected as a fixed amount per gallon of gasoline sold. The Oregon gas tax is currently 30 cents per gallon, increased from 24 cents per gallon on January 1, 2011. Because it is levied on a per gallon basis, the revenue does not vary with changes in gasoline prices. Since increases do not keep up with inflation, the value of this revenue has eroded over time as maintenance materials and repair costs have increased. Additionally, increased fuel efficiency in new vehicles has further reduced the total dollars collected relative to total miles driven.

Oregon vehicle registration fees are collected as a fixed amount at the time a vehicle is registered with the Department of Motor Vehicles. Vehicle registration fees in Oregon have recently increased to about \$43 per year per vehicle. Vehicle registration fees are not adjusted for inflation.

In fiscal year 2011/2012, the City received roughly \$1,110,000 from the Oregon Highway Trust Fund. The City's projected share of this fund is approximately \$27.1 million over the next 22 years.

These funds are flexible and are available for either capital or maintenance projects.

Bike Path Fund

One percent (1.0%) of the payments from the Highway Trust Fund must be reserved for the maintenance and construction of bicycle facilities. In fiscal year 2011/2012, the City received \$11,110 from this revenue source and expects to receive \$271,600 over the next 22 years. Although these monies may only be spent on bicycle facilities, they are classified as unrestricted because they can contribute to capital or maintenance projects.

Street Surface Maintenance Fee

The street maintenance fee is paid by all City of Milwaukie utility customers (residents, businesses, government units, etc.) through their utility bill and is based on an estimate of daily trips generated by each customer. In fiscal year 2011/2012, revenues were approximately \$609,000, and the fee is expected to generate \$13.4 million over the next 22 years. Monies collected from this fee are dedicated to the Street Surface Maintenance Program (SSMP) for roadway surface preservation, including maintenance, rehabilitation, and reconstruction. They cannot be used to construct capital projects.

Portland General Electric (PGE) Privilege Tax

Similar to franchise fees, the PGE Privilege Tax is paid by a utility (in this case PGE) in exchange for the use of the public right-of-way. The rate approved by the Milwaukie City Council is 1.5% of Milwaukie customers' bills. In fiscal year 2011/2012, the City received revenue of \$324,400 from this source. Revenues for the next 22 years are projected to total nearly \$7.7 million. Monies collected from this tax are dedicated to the Street Surface Maintenance Program (SSMP) for roadway surface preservation, including maintenance, rehabilitation, and reconstruction. They cannot be used to construct capital projects.

Local Gas Tax

The City of Milwaukie local gas tax of two cents per gallon went into effect in April 2007. Revenue generated in fiscal year 2011/2012 was approximately \$179,000. Over the next 22 years, the total revenue from this source is expected to be approximately \$4.4 million. Monies collected from this tax are dedicated to the Street Surface Maintenance Program (SSMP) for roadway surface preservation, including maintenance, rehabilitation, and reconstruction. They cannot be used to construct capital projects.

Projected Transportation Revenue

Table 13-1 summarizes the current, anticipated, and approved funding sources and the estimated revenue available to the City of Milwaukie for transportation-related projects over the next 22 years. Total projected revenues over the next 22 years are approximately \$1.2 million restricted for capital projects, \$25.5 million restricted for maintenance projects, and \$50.9 million for either capital or maintenance projects (unrestricted).

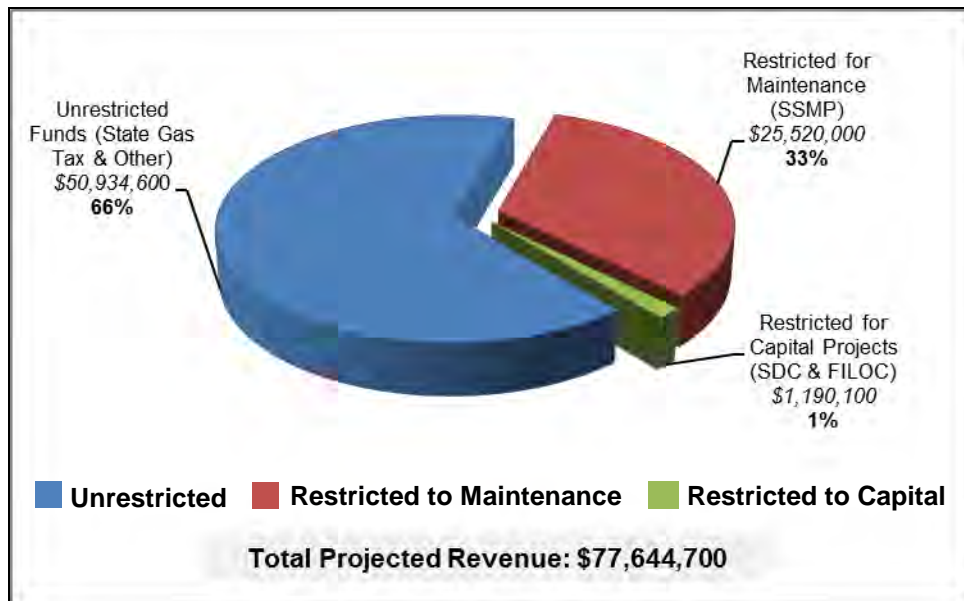
**Table 13-1 Projected Transportation Revenue
for the 22-Year Planning Period (in 2012 dollars)**

Funding Source	Capital	Unrestricted	Maintenance	TOTAL
SDC and FILOC ²	\$1,190,100			\$1,190,100
Franchise Fees		\$23,716,000		23,716,000
State Gas Tax		26,887,000		26,887,000
Bike Path Fund		271,600		271,600
Street Maintenance Fee			\$13,420,000	13,420,000
PGE Privilege Tax			7,744,000	7,744,000
Local Gas Tax			4,356,000	4,356,000
Other Revenue		60,000		\$60,000
Projected Revenue (2014 to 2035)³	\$1,190,100	\$50,934,600	\$25,520,000	\$77,644,700

The three line items in Table 13-1 that are specifically restricted to funding maintenance projects (street maintenance fee, PGE privilege tax, and local gas tax) have been designated by City Council as the exclusive funding sources for the City's Street Surface Maintenance Program (SSMP). Projects eligible for SSMP funding include major rehabilitation and reconstruction of roadways. Routine street maintenance (e.g., filling potholes or patching asphalt) must be funded from the "unrestricted" sources in Table 13-1.

Figure 13-1 provides a graphic depiction of the information presented in Table 13-1, showing the makeup of anticipated revenue for the 22-year planning period.

**Figure 13-1 Projected Transportation Revenue
for the 22-Year Planning Period (in 2012 dollars)**



² Figure includes \$444,500 of FILOC money currently in City coffers (unspent to date) in addition to \$280,000 of projected FILOC revenue as estimated over the 22-year planning period.

³ Projections for these funding sources were made based on the most recent year, with the exception of FILOC and SDC revenue. Because FILOC and SDC revenue is more variable, the projection is based on an average involving three years of actual revenues with an estimated small annual increase.

CAPITAL AND MAINTENANCE PROJECTS

Based on current figures, projected costs for operations and maintenance over the 22-year planning period total approximately \$77.2 million. Table 13-2 provides a detailed breakdown of these costs. As noted in Table 13-1, estimated revenues for the same time frame are approximately \$77.6 million. However, some of those funds (approximately \$1.2 million) are specifically restricted to capital projects, so there is some projected shortfall for operations and maintenance over the 22-year planning period. Not only does this mean that additional funds will be necessary simply to cover projected operational and maintenance costs, but also that the unrestricted revenues will be effectively unavailable for capital projects.

A minimum of approximately \$272,000 must be spent on bicycle projects (capital or maintenance), or the City must forego expending the 1% of Highway Trust Fund revenues that must be devoted to bicycle facilities. But given that the regular sweeping of streets with bike lanes accounts for an annual Operations and Maintenance expenditure of approximately \$50,000 (or \$1.2 million over the 22-year planning period), this requirement is met 4 times over by that one operational project.

**Table 13-2 Operations, Maintenance, and Capital Costs
for the 22-Year Planning Period (in 2012 dollars)**

Projects	Cost*
Operations	
Indirect, Overhead, and Administrative Support Costs	\$20,307,000
Street Lighting	7,956,000
Subtotal	\$28,263,000
Maintenance	
Street Surface Maintenance Program	\$25,520,000
Traditional Maintenance Activities (sweeping, striping, signage, etc.)	22,170,000
Other Maintenance (from Consolidated Action Plan) ⁴	1,206,000
Subtotal	\$48,896,000
Capital	
Capital Projects (from Consolidated Action Plan) ⁵	\$3,839,200
Subtotal	\$3,839,200
Total Approximate Costs (2014 to 2035)	\$80,998,200

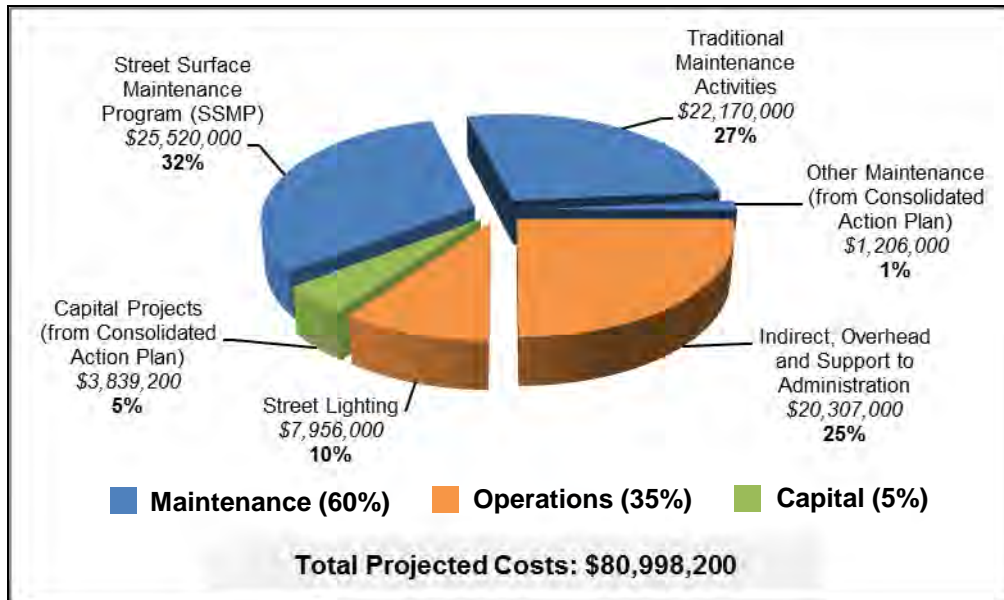
*Approximate Costs

⁴ Represents that portion of the cost of regular street sweeping that is spent on designated bike routes.

⁵ Costs include all projects on the Consolidated Action Plan (Table 13-3). An 11% local match share was used for estimation purposes, except for directly funded projects

Table 13-2 demonstrates how the City can allocate available funds given their restrictions. Figure 13-2 provides a graphic depiction of the information presented in Table 13-2, showing the breakdown of anticipated costs for the 22-year planning period.

Figure 13-2 Projected Transportation Costs for the 22-Year Planning Period (in 2012 dollars)⁶



With limited local funding and many needs, the City will continually strive to allocate investments for projects that best meet the goals as outlined in Chapter 2. The action plans—in Chapters 5, 6, 7, 8, 9, 11, and 12—contain those projects that the City has prioritized most highly and intends to find funding for within the 22-year planning period.

In the past 7 to 8 years, the City has allocated transportation expenditures in the following manner.

Maintenance-related expenses account for about 55% of spending and include:

- Approximately 35% to traditional maintenance (personnel, materials, and services for general operations and maintenance).
- Approximately 20% to the Street Surface Maintenance Program.

Operations-related expenses account for about 40% of spending and include:

- Approximately 25% for indirect, overhead, and administrative support costs.
- Approximately 15% for street lighting.

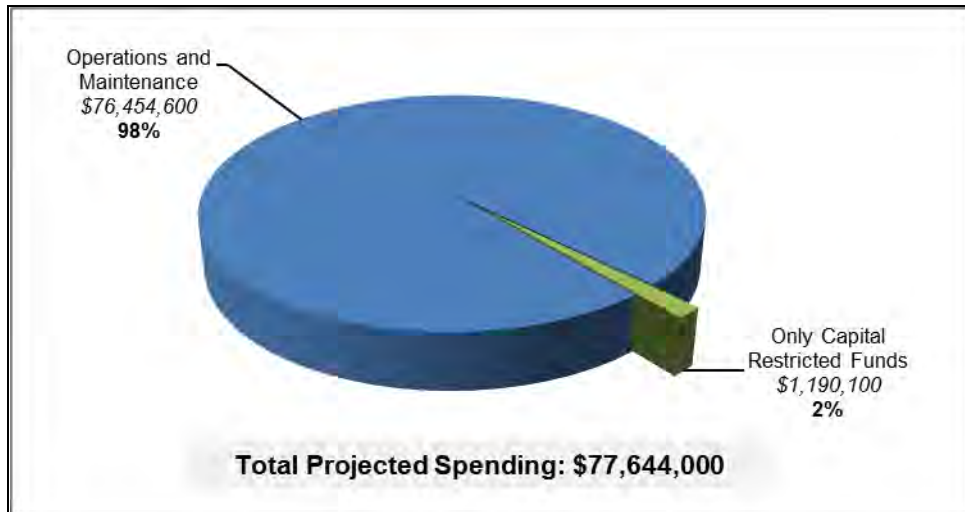
Approximately 5% of annual spending has been directed to capital projects to improve the transportation system.

Projected costs over the 22-year planning period are greater than projected revenues by \$3.5 million, or about 4%. If the City chooses not to reduce operations and maintenance expenses, and if no additional revenue sources are identified, the only revenues available for capital

⁶ Costs include all projects on the Consolidated Action Plan (Table 13-3). An 11% local match share was used for estimation purposes, except for directly funded projects

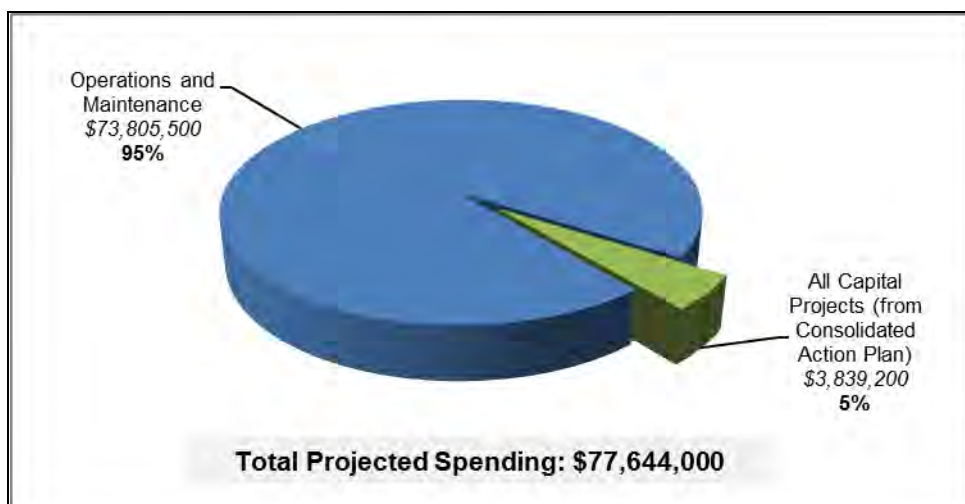
projects will be the SDC and FILOC funds. Over the 22-year planning period, these revenues are projected to be about \$1.2 million and will cover only 31% of the approximately \$3.8 million needed to fund all projects on the Consolidated Action Plan. This scenario represents spending approximately 2% of transportation revenues on capital projects and is depicted in Figure 13-3.

Figure 13-3 Spending Scenario 1: Funding Limited to Capital-Restricted Revenue over the 22-Year Planning Period (in 2012 dollars)



Alternately, in order to implement all the capital projects listed in the Consolidated Action Plan (Table 13-3), the City will need to reduce operations and maintenance expenses by about 6%, assuming no additional revenue sources are identified. This scenario represents spending approximately 5% of transportation revenues on capital projects and is depicted in Figure 13-4.

Figure 13-4 Spending Scenario 2: Funding All Capital Projects on Consolidated Action Plan over the 22-Year Planning Period (in 2012 dollars)



Project Cost Estimates

Order-of-magnitude cost estimates were developed for all projects identified in the modal master plans using general unit costs for transportation improvements. However, these estimates do not reflect unique project elements that can significantly add to project costs. More detailed project cost estimates will be developed as projects move closer to implementation, including detailed right-of-way requirements and costs associated with special designs. Because multiple modal improvements may occur on the same facility, costs were developed at a project level incorporating all modes, as appropriate. It may be desirable to break project mode elements out separately. However, in most cases, there are greater cost efficiencies in undertaking multiple modal improvements at the same time.

The Consolidated Action Plan project list (Table 13-3) presents the projects from all of the mode-specific action plans in a single table. The Prioritized Master Plan project list in Table 13-4 (at the end of this chapter) lists all of the proposed TSP projects that have been generated through the TSP planning process, grouping them by priority (High, Medium, Low).

Table 13-3 Consolidated Action Plan

On Action Plan List from TSP Chapter(s)	Project Name	Project Description	From	To	Project Cost (\$1,000s)	Direct Funding or Grant Match
Pedestrian & Bicycle	17th Ave Improvements	Fill in sidewalk gaps on both sides of street, fill in gaps in existing bicycle network with bike lanes, and/or provide multiuse path. Improve intersection safety at Milport Rd, McBrod Ave, Hwy 224, Lava Dr, and Hwy 99E.	Ochoco St	McLoughlin Blvd	\$1,000	Match
Pedestrian, Bicycle, Public Transit	Railroad Ave Capacity Improvements	Pedestrian aspect: Fill in sidewalk gaps on both sides of street or construct multiuse path on one side.	37th Ave	Harmony Rd	\$1,800	Match
		Bicycle aspect: Fill in gaps in existing bicycle network with bike lanes, cycle track, multiuse path, or other facilities.	37th Ave	Linwood Ave	\$4,800	Match
		Public transit aspect: Provide bus service to extend to Clackamas Town Center and points east.	Harrison St	Eastern city limits	TBD	Direct (TriMet)
Pedestrian & Bicycle	Monroe St Neighborhood Greenway	Pedestrian aspect: Fill in sidewalk gaps on both sides of street.	42nd Ave	City limits	\$1,800	Match
		Bicycle aspect (downtown): Designate as a "neighborhood greenway" and install traffic-calming improvements.	21st Ave	Hwy 224	\$85	Match
		Bicycle aspect (central): Designate as a "neighborhood greenway" and install traffic-calming improvements.	Hwy 224	42nd Ave	\$80	Match
		Bicycle aspect (east): Designate as a "neighborhood greenway" and install traffic-calming improvements.	42nd Ave	Linwood Ave	\$165	Match
Pedestrian & Bicycle	Kellogg Creek Dam Removal and Hwy 99E Underpass	Replace Hwy 99E bridge over Kellogg Creek, remove dam, restore habitat. Construct bike/ped undercrossing between downtown Milwaukie and Riverfront Park.	Location-specific	Location-specific	\$9,900	Match
Pedestrian & Street	Intersection Improvements at McLoughlin Blvd and 22nd Ave	Improve safety of Trolley Trail crossing at 22nd Ave.	Location-specific	Location-specific	\$200	Match
Pedestrian & Bicycle	Stanley Ave Neighborhood Greenway (north)	Pedestrian aspect: Fill in sidewalk gaps on both sides of street.	Johnson Creek Blvd	King Rd	\$1,900	Match
		Bicycle aspect: Designate as a "neighborhood greenway" and install traffic-calming improvements.	Springwater Trail	King Rd	\$135	Match

On Action Plan List from TSP Chapter(s)	Project Name	Project Description	From	To	Project Cost (\$1,000s)	Direct Funding or Grant Match
Pedestrian & Bicycle	Stanley Ave Neighborhood Greenway (south)	Pedestrian aspect: Fill in sidewalk gaps on both sides of street.	King Rd	Railroad Ave	\$2,800	Match
		Bicycle aspect: Designate as a "neighborhood greenway" and install traffic-calming improvements.	King Rd	Railroad Ave	\$195	Match
Pedestrian & Bicycle	Kronberg Park Trail	Construct multiuse path to connect bike/ped bridge to safe crossing of Hwy 99E	Kellogg Creek Bridge	River Rd at Hwy 99E	\$300	Match
Pedestrian & Bicycle	Kellogg Creek Bike/Ped Bridge	Construct bike/ped overpass over Kellogg Creek in conjunction with light rail bridge.	Lake Rd	Kronberg Park	\$2,500	Match
Pedestrian & Street	Intersection Improvements at Hwy 224 Crossings	Pedestrian aspect: Improve pedestrian crossings at Freeman Way, 37th Ave, Oak St, Monroe St, and Harrison St	Location-specific	Location-specific	\$100 (\$20 each)	Match
		Street aspect: Add left-turn lanes and protected signal phasing on Oak St approaches.	Location-specific	Location-specific	\$20	Match
Pedestrian	Study of Pedestrian Crossings on Hwy 224	Examine alternatives for improving pedestrian crossings at five intersections along Hwy 224 (Harrison St, Monroe St, Oak St, 37th Ave, Freeman Way)	Harrison St	Freeman Way	\$50	Match
Pedestrian	Adams St Connector	Construct pedestrian- and bicycle-only facility on Adams St between 21st Ave and Main St	21st Ave	Main St	\$450	Match
Pedestrian	Linwood Ave Sidewalks (south)	Fill in sidewalk gaps on both sides of street.	King Rd	Railroad Ave	\$2,150	Match
Bicycle	29th/Harvey/40th Neighborhood Greenway	Designate as a "neighborhood greenway" and install traffic-calming improvements.	Springwater Trail	Monroe St	\$220	Match
Public Transit	Downtown Transit Center Improvements	Construct new bus layover facility outside of the downtown core.	Location-specific	Location-specific	\$1,250	Match
Public Transit	Downtown Loop Bus	Establish bus service from downtown to Tacoma and Park Ave stations.	Downtown	Tacoma station, Park Ave station	TBD	Direct (TriMet)
Public Transit	Neighborhood Loop Bus	Establish bus service between eastern neighborhoods and downtown.	Eastern city limits	Downtown	TBD	Direct (TriMet)
Parking	Downtown Parking Management	Implement a downtown parking management system, including a dedicated parking manager.	Downtown	Downtown	\$40	Direct

On Action Plan List from TSP Chapter(s)	Project Name	Project Description	From	To	Project Cost (\$1,000s)	Direct Funding or Grant Match
Parking	Downtown Parking Signage	Install wayfinding and identification signage at McLoughlin Blvd intersections and around public parking lots.	Downtown	Downtown	\$10	Direct
Nhbrhd Traffic Mgmt	Walk Safely Milwaukie Program	Complete a few small traffic-calming and pedestrian safety projects throughout the city each year.	Citywide	Citywide	\$300 (\$13 annually) ⁷	Direct
Street & Freight	Hwy 224 & Hwy 99E Refinement Plan	Conduct refinement study to establish alternative mobility targets for Hwy 224 and McLoughlin Blvd for locations not meeting applicable state targets, and explore ways to minimize barrier effect and improve auto and freight mobility.	Hwy 99E Project Limits: Tacoma St to River Rd	Hwy 224 Project Limits: Hwy 99E to Lake Rd Interchange	\$270	Match
Bicycle	Bike Lane Maintenance	Sweep bike lanes to remove debris.	Citywide	Citywide	\$1,200	Direct

POTENTIAL NEW FUNDING SOURCES

The master plan project lists in Chapters 5-9, 11, and 12 include a large number of unfunded, but nonetheless high-priority, projects and programs. Absent an increase in funding, the City will be unable to address operational deficiencies identified in Chapter 4. The City may wish to consider new revenue sources to ensure that funding is available for proposed capital projects and other transportation programs.

In addition, the City is contributing \$5 million in match to the regional share of the Portland-Milwaukie Light Rail (PMLR) project. The vast majority of the City's transportation revenues are restricted in ways that do not allow the City to expend them on a light rail "match." SDC revenues, the only significant transportation revenue stream that could contribute to the project, are not projected to be adequate to cover the local match over the next 22 years.

The Milwaukie share of the PMLR project is not included on the Public Transit Action Plan list because it will require revenues above and beyond those included in the baseline revenue projection.

Many cities use some combination of the following funding sources to supplement their capital and/or maintenance budgets.

General Fund Revenues

At the discretion of the City Council, the City can contribute General Fund revenues to transportation projects and programs. General Fund revenues primarily include property taxes, use taxes, and other miscellaneous taxes and fees imposed by the City. Competing community priorities set by the City Council limit the funding potential of this approach. General Fund resources can fund any aspect of the system, from capital improvements to operations,

⁷ Historically, the Neighborhood Pedestrian and Traffic Safety Program received \$13,000 annually. In more recent years, the program name changed to Walk Safely Milwaukie and funding was raised to \$100,000 annually. Future funding for the program will be evaluated on a biennial basis with the budget.

maintenance, and administration. Additional revenues available from this source are only available to the extent that either General Fund revenues are increased or City Council diverts funding from other City programs.

Expanded SDC Rate for Transportation

The City's transportation SDC rate is \$1,676 per p.m.-peak-hour trip generated. A more typical transportation SDC in the Portland metro area is approximately \$2,000 per single-family residence (or p.m.-peak-hour trip generated). A regional examination of combined SDC and development fee costs conducted by the City of Portland found that the City of Milwaukie charges less than the majority of other jurisdictions (17th out of 21 overall) and has particularly low rates for residential uses.

Given that a large number of needs have been identified, a higher transportation SDC rate is warranted. The projects identified in this TSP will help the City maintain quality of life for its residents and businesses as the City experiences continued growth. It is appropriate to ensure that growth pays a fair and commensurate share of the costs of these new facilities.

In addition to reevaluating the SDC rate, the City may wish to consider tightening its policy on SDC credits. The City currently allows a credit against SDCs due for any privately funded transportation development that increases capacity. However, the City may wish to change this policy to allow SDC credits for only those privately funded projects that are identified in the City's adopted TSP, i.e., those improvements which have been identified as most important to the overall system. A modification of the City's municipal code would be required to implement this change.

Urban Renewal District

An Urban Renewal District (URD) is a mechanism by which the growth of tax revenues for a specific period of time is "captured" to pay for projects within the district. Typically, the sponsoring agency seeks bond financing of such projects and then repays those bonds with the "tax increment" generated in the area. The "tax increment" is the growth in tax revenue; the "frozen base," i.e., the property tax revenue already being generated, continues to flow to the appropriate taxing jurisdictions. All of the "tax increment" (the amount above the frozen base) goes towards retiring the urban renewal debt. This type of "tax increment" financing has been used in Oregon since 1960 to fund a wide variety of projects including transportation improvements. Recent public discussions about this funding mechanism have demonstrated some opposition to the concept; however, it remains in the TSP as an option to be revisited over the 22-year planning period.

Local Improvement District Assessment Revenue

The City may set up Local Improvement Districts (LIDs) to fund specific capital improvement projects within defined geographic areas, or zones of benefit. LIDs impose assessments on properties within its boundaries. LIDs cannot fund ongoing maintenance costs. They require separate accounting processes, and the assessments collected can only be spent on capital projects within the geographic area. Citizens representing 67% of the assessment can terminate an LID and overturn the planned projects, except in cases of emergency or sidewalk projects.

Direct Appropriations

The City can seek direct appropriations from the State Legislature and/or U.S. Congress for transportation capital improvements. In 2006, the City received this kind of funding for Lake Rd

improvements and will likely continue to pursue these special, one-time appropriations for major City projects.

Special Assessments

Special assessments allow local jurisdictions, with the agreement of property owners, to put into place additional property taxes to pay for specific capital projects or ongoing costs. A variety of special assessments are available in Oregon to fund a range of improvements, including sidewalks, curbs, gutters, street lighting, parking structures, and downtown or commercial zone transportation improvements. For example, the local share of funding for TriMet's Westside light rail project was paid for by a special assessment with voter approval. These assessments are commonly counted as revenue towards the limitations established by Measure 50.

Debt Financing

While not a direct funding source, debt financing can be used to spread costs over the useful life of a project. Though interest costs are incurred, the use of debt financing can serve not only as a practical means of funding major improvements, but can also be a more equitable funding strategy, spreading the burden of repayment over existing and future customers who will benefit from the projects. The obvious caution in relying on debt service is that a funding source must be identified to fulfill annual repayment obligations.

Voter-Approved General Obligation Bonds

Subject to voter approval, the City can issue General Obligation (GO) bonds to debt finance capital improvement projects. GO bonds are backed by the "full faith and credit" of the jurisdiction and provide increased taxing authority with which the City can generate revenues to make principal and interest repayments. For critical projects, the electorate may be willing to accept increased taxation. Proceeds may not be used for ongoing maintenance.

Revenue Bonds

Revenue bonds are debt instruments secured by rate revenue. In order for the City to issue revenue bonds for transportation projects, it would need to identify a stable source of ongoing rate funding. Interest costs for revenue bonds are slightly higher than for general obligation bonds, due to the perceived stability offered by the "full faith and credit" of a jurisdiction.

Oregon Transportation Infrastructure Bank Loans

The Oregon Transportation Infrastructure Bank Loan program is a statewide revolving loan fund designed to promote innovative transportation funding solutions. The Financial Services Branch of ODOT provides State support for the program. In general, eligible projects include highway, transit, bikeway, and pedestrian access projects. Projects are rated on established criteria and recommended based on the rankings. Repayment of loans must begin within 5 years of project completion and must be complete within 30 years or at the end of the useful life of the project.

TSP IMPLEMENTATION AND UPDATE STEPS

The primary function of the TSP is to provide guidance for long-range policy and investment decisions about needed improvements to the transportation system over the next 22 years. The Consolidated Action Plan in Table 13-3 provides a list of the highest-priority projects for the community. This list is utilized to build the "Transportation Priority Project—Unfunded" section of the City's Capital Improvement Plan (CIP). The CIP is a list of projects for the City's water, wastewater, stormwater, and transportation systems that are scheduled to be funded in the

short term. As funding becomes available, projects are moved from the unfunded section of the CIP to the section recommended for funding. Projects in the CIP section recommended for funding are reviewed for funding every 2 years through the City's budgeting process. In essence, the CIP is the primary implementation mechanism for TSP projects.

This document requires a series of implementing and on-going update steps to retain its usefulness over the next 22 years. Such steps include refining and updating the affected design standards for streets and trails, implementing the suggested development code and Comprehensive Plan text changes, and periodically updating and reviewing traffic forecasts and project priorities. The State suggests that cities should update local TSPs every 5 years to keep current on the latest land development trends, capital project funding conditions, and priorities of the community. These activities would typically be funded through a combination of grants, engineering funds, and planning funds, and are not, therefore, included in the financial projections for the modal action plans.

Table 13-4 Prioritized Master Plan Project List

Project Name	TSP Chapter	Project Description	From	To	Estimated Cost (\$1,000s) ⁸	Priority Ranking ⁹	Is Project in Action Plan?	Project Type
HIGH PRIORITY PROJECTS								
17 th Ave Improvements	Pedestrian & Bicycle	Fill in sidewalk gaps on both sides of street, fill in gaps in existing bicycle network with bike lanes, and/or provide multiuse path. Improve intersection safety at Milport Rd, McBrod Ave, Hwy 224, Lava Dr, and Hwy 99E.	Ochoco St	McLoughlin Blvd	\$1,000	High	Yes	Capital
Railroad Ave Capacity Improvements	Pedestrian, Bicycle & Transit	Pedestrian aspect: Fill in sidewalk gaps on both sides of street or construct multiuse path on one side.	37 th Ave	Harmony Rd	\$1,800	High	Yes	Capital
		Bicycle aspect: Fill in gaps in existing bicycle network with bike lanes, cycle track, multiuse path, or other facilities.	37 th Ave	Linwood Ave	\$4,800	High	Yes	Capital
		Transit aspect: Provide bus service to extend to Clackamas Town Center and points east.	Harrison St	Eastern city limits	TBD	High	Yes	Service Enhancements
Monroe St Neighborhood Greenway (downtown)	Bicycle	Designate as a "neighborhood greenway" and install traffic-calming improvements.	21 st Ave	Hwy 224	\$85	High	Yes	Capital
Monroe St Neighborhood Greenway (central)	Bicycle	Designate as a "neighborhood greenway" and install traffic-calming improvements.	Hwy 224	42 nd Ave	\$80	High	Yes	Capital
Monroe St Neighborhood Greenway (east)	Bicycle & Pedestrian	Bicycle aspect: Designate as a "neighborhood greenway" and install traffic-calming improvements.	42 nd Ave	Linwood Ave	\$165	High	Yes	Capital
		Pedestrian aspect: Fill in sidewalk gaps on both sides of street.	42 nd Ave	City limits	\$1,800	High	Yes	Capital
Stanley Ave Neighborhood Greenway (north)	Bicycle & Pedestrian	Bicycle aspect: Designate as a "neighborhood greenway" and install traffic-calming improvements.	Springwater Trail	King Rd King Rd	\$135	High	Yes	Capital
		Pedestrian aspect: Fill in sidewalk gaps on both sides of street	Johnson Creek Blvd		\$1,900	High	Yes	Capital
Stanley Ave Neighborhood Greenway (south)	Bicycle & Pedestrian	Bicycle aspect: Designate as a "neighborhood greenway" and install traffic-calming improvements.	King Rd	Railroad Ave	\$195	High	Yes	Capital
		Pedestrian aspect: Fill in sidewalk gaps on both sides of street	King Rd	Railroad Ave	\$2,800	High	Yes	Capital
Downtown Transit Center Improvements	Transit	Construct new bus layover facility outside of the downtown core.	Location-specific	Location-specific	\$1,250	High	Yes	Capital
Kellogg Creek Dam Removal and Hwy 99E Underpass	Pedestrian & Bicycle	Replace Hwy 99E bridge over Kellogg Creek, remove dam, restore habitat. Construct bike/ped undercrossing between downtown Milwaukie and Riverfront Park.	Location-Specific	Location-Specific	\$9,900	High	Yes	Capital
29 th /Harvey/40 th Neighborhood Greenway	Bicycle	Designate as a "neighborhood greenway" and install traffic-calming improvements.	Springwater Trail	Monroe St	\$220	High	Yes	Capital
Bike Lane Maintenance	Bicycle	Sweep bike lanes to remove debris.	Citywide	Citywide	\$1,200	High	Yes	Operational

⁸ Project costs are order-of-magnitude estimates and are in 2012 dollars. Future costs may be more due to inflation. In the case of operational projects, estimated costs are for the entire 22-year planning period.

⁹ Projects are ranked as either high, medium, or low. They are in no particular order within their ranking.

Project Name	TSP Chapter	Project Description	From	To	Estimated Cost (\$1,000s) ⁸	Priority Ranking ⁹	Is Project in Action Plan?	Project Type
Study of Pedestrian Crossings on Hwy 224	Pedestrian	Examine alternatives for improving pedestrian crossings at five intersections along Hwy 224 (Harrison St, Monroe St, Oak St, 37 th Ave, Freeman Way)	Harrison St	Freeman Way	\$50	High	Yes	Policy
Intersection Improvements at Hwy 224 and Oak St	Street	Add left-turn lanes and protected signal phasing on Oak St approaches.	Location-specific	Location-specific	\$20	High	Yes	Capital
Walk Safely Milwaukee Program	Nbrhd Traffic Management	Complete a few small traffic-calming and pedestrian safety projects throughout the city each year.	Citywide	Citywide	\$300 (\$13 annually)	High	Yes	Capital
Hwy 224 & Hwy 99E Refinement Plan	Street & Freight	Conduct refinement study to establish alternative mobility targets for Hwy 224 and McLoughlin Blvd for locations not meeting applicable state targets, and explore ways to minimize barrier effect and improve auto and freight mobility.	Hwy 99E Project Limits: Tacoma St to River Rd	Hwy 224 Project Limits: Hwy 99E to Lake Rd Interchange	\$270	High	Yes	Capital
Harrison St Railroad Crossing Separation	Freight	Upgrade Harrison crossing of Union Pacific Railroad tracks to grade-separated facility. Assess as part of Hwy 224 & Hwy 99E Refinement Plan.	Location-specific	Location-specific	\$30,700	High	No	Capital
Intersection Improvements at Hwy 224 and 37 th Ave	Street & Freight	Consolidate the two northern legs of 37 th Ave and International Way into one leg at Hwy 224.	Location-specific	Location-specific	\$2,100	High	No	Capital
Linwood Ave Capacity Improvements (north)	Street	Widen to standard three lane cross section. Widen bridge over Johnson Creek.	Johnson Creek Blvd	King Rd	\$9,300	High	No	Capital
Linwood Ave Capacity Improvements (south)	Street	Widen to standard three lane cross section.	King Rd	Harmony Rd	\$12,500	High	No	Capital
Hwy 224 Crossing Improvements at Oak and Washington Sts	Bicycle	Improve intersection crossing safety for bicyclists at Washington St and Oak St.	Location-specific	Location-specific	\$10	High	No	Capital
Downtown Parking Management	Parking	Implement a downtown parking management system, including a dedicated parking manager.	Downtown	Downtown	\$40	High	Yes	Operational
Kellogg Creek Bike/Ped Bridge	Pedestrian & Bicycle	Construct bike/ped overpass over Kellogg Creek in conjunction with light rail bridge.	Lake Rd	Kronberg Park	\$2,500	High	Yes	Capital
Kronberg Park Trail	Pedestrian & Bicycle	Construct multiuse path to connect bike/ped bridge to safe crossing of Hwy 99E.	Kellogg Creek Bridge	River Rd	\$300	High	Yes	Capital
Adams St Connector	Pedestrian	Construct pedestrian- and bicycle-only facility on Adams St between 21 st Ave and Main St	21 st Ave	Main St	\$450	High	Yes	Capital
43 rd Ave Sidewalks	Pedestrian	Fill in sidewalk gaps on both sides of street.	Howe St/ 42 nd Ave	King Rd/ 43 rd Ave	\$600	High	No	Capital
Harmony Rd Sidewalks	Pedestrian	Fill in sidewalk gaps on both sides of street.	Linwood Ave	City limits	\$40	High	No	Capital
International Way Sidewalks	Pedestrian	Fill in sidewalk gaps on both sides of street	Criterion Ct	Lake Rd	\$840	High	No	Capital
River Rd Sidewalks	Pedestrian	Fill in sidewalk gaps on both sides of street.	McLoughlin Blvd	City limits	\$690	High	No	Capital
Intersection Curb Ramp Improvements	Pedestrian	Install curb ramps at all intersections with sidewalks (approximately 700 intersections).	Citywide	Citywide	\$3,500	High	No	Capital

Project Name	TSP Chapter	Project Description	From	To	Estimated Cost (\$1,000s) ⁸	Priority Ranking ⁹	Is Project in Action Plan?	Project Type
Intersection Improvements at Hwy 224 and 37 th Ave	Pedestrian	Improve pedestrian crossing.	Location-specific	Location-specific	\$20	High	Yes	Capital
Intersection Improvements at Hwy 224 and Freeman Way	Pedestrian	Improve pedestrian crossing.	Location-specific	Location-specific	\$20	High	Yes	Capital
Intersection Improvements at Hwy 224 and Harrison St	Pedestrian	Improve pedestrian crossing.	Location-specific	Location-specific	\$20	High	Yes	Capital
Intersection Improvements at Hwy 224 and Monroe St	Pedestrian	Improve pedestrian crossing.	Location-specific	Location-specific	\$20	High	Yes	Capital
Intersection Improvements at Hwy 224 and Oak St	Pedestrian	Improve pedestrian crossing.	Location-specific	Location-specific	\$20	High	Yes	Capital
Linwood Ave Sidewalks (south)	Pedestrian	Fill in sidewalk gaps on both sides of street.	King Rd	Railroad Ave	\$2,150	High	Yes	Capital
Bicycle-friendly Street Grates	Bicycle	Install bicycle-friendly street grates.	Citywide	Citywide	\$60	High	No	Operational
Intersection Improvements at Linwood Ave and Monroe St	Bicycle	Improve safety of crossing at intersection.	Location-specific	Location-specific	\$10	High	No	Capital
Lake Rd Bike Lanes	Bicycle	Fill in gaps in existing bicycle network with bike lanes.	Main St	Guilford Dr	\$3,400	High	No	Capital
Stanley Ave Connectivity at King Rd	Street	Enhance connection along Stanley Ave at King Rd.	Location-specific	Location-specific	\$60	High	No	Capital
Stanley Ave Connectivity at Monroe St	Street	Enhance connection along Stanley Ave at Monroe St.	Location-specific	Location-specific	\$60	High	No	Capital
Intersection Improvements at McLoughlin Blvd and 22 nd Ave	Pedestrian, Bicycle, & Street	Improve safety of Trolley Trail crossing at 22 nd Ave.	Location-specific	Location-specific	\$200	High	Yes	Capital
Improved Connection to Springwater Trail at 29 th Ave and Sherrett St	Pedestrian & Bicycle	Pave the connection to Springwater Trail at 29 th Ave and Sherrett St. (TSAP)	Location-specific	Location-specific	\$20	High	No	Capital
Downtown Loop Bus	Transit	Establish bus service from downtown to Tacoma and Park Ave stations.	Downtown	Tacoma station, Park Ave station	TBD	High	Yes	Service Enhancement
Neighborhood Loop Bus	Transit	Establish bus service between eastern neighborhoods and downtown.	Eastern city limits	Downtown	TBD	High	Yes	Service Enhancement
Milwaukie Transportation Management Association Program	Transit	Implement a transportation management association for downtown employers.	Milwaukie Town Center	Milwaukie Town Center	\$200	High	No	Operational
Improved Connection from Springwater Trail to Pendleton Site (Ramps)	Pedestrian & Bicycle	Construct ramps to improve existing connection of Springwater Trail to Pendleton site at Clatsop St. (TSAP)	Location-specific	Location-specific	\$630	High	No	Capital

Project Name	TSP Chapter	Project Description	From	To	Estimated Cost (\$1,000s) ⁸	Priority Ranking ⁹	Is Project in Action Plan?	Project Type
Improved Connection from Springwater Trail to Pendleton Site (Widened Undercrossing)	Pedestrian & Bicycle	Widen existing undercrossing to improve connection of Springwater Trail to Pendleton site at Clatsop St. (TSAP)	Location-specific	Location-specific	\$100	High	No	Capital
Improved Connection from Springwater Trail to Tacoma Station	Pedestrian	Construct stairs to connect Springwater Trail to Tacoma station. (TSAP)	Location-specific	Location-specific	\$80	High	No	Capital
Signage and Intersection Improvements at McLoughlin Blvd and Ochoco St	Freight	Establish signage for trucks and improve intersection. (TSAP)	Location-specific	Location-specific	\$1,600	High	No	Capital
Downtown Parking Signage	Parking	Install wayfinding and identification signage at McLoughlin Blvd intersections and around public parking lots.	Downtown	Downtown	\$10	High	Yes	Capital
Public Parking Structure	Parking	Construct 3- to 4-story public parking structure with retail at ground floor for visitor/employee parking.	Location-specific	Location-specific	\$11,000	High	No	Capital
MEDIUM PRIORITY PROJECTS								
Lake Rd Sidewalks	Pedestrian	Fill in sidewalk gaps on both sides of street.	Where Else Ln	Hwy 224	\$2,200	Medium	No	Capital
19 th Ave and Sparrow St Neighborhood Greenway	Bicycle	Designate as a "neighborhood greenway" and install traffic-calming improvements. This would connect the south end of Kellogg Creek Trail to River Rd.	Eagle St	River Rd	\$800	Medium	No	Capital
Intersection Improvements at Main St and Mailwell Dr	Freight	Upgrade intersection turning radii to better accommodate freight movements.	Location-specific	Location-specific	\$60	Medium	No	Capital
McLoughlin Blvd Sidewalks	Pedestrian	Fill in sidewalk gaps on both sides of street.	Washington St	Southern city limits	\$650	Medium	No	Capital
Pedestrian Walkway Amenities	Pedestrian	Install amenities, such as benches, along key walking routes.	Citywide	Citywide	\$60	Medium	No	Capital
Intersection Improvements at McLoughlin Blvd and 17 th Ave	Street	Prohibit left-turn movement from 17 th Ave to northbound McLoughlin Blvd and include in Hwy 224 & Hwy 99E Refinement Plan.	Location-specific	Location-specific	\$20	Medium	No	Capital
Intersection Improvements at McLoughlin Blvd and River Rd	Street	Consolidate a single access point for the area at Bluebird St with full intersection treatment and signalization or add second northbound left-turn lane at River Rd.	Location-specific	Location-specific	\$980	Medium	No	Capital
Harrison St and King Rd Connection	Street	Enhance connection between King Rd and Harrison St at 42 nd Ave.	Location-specific	Location-specific	\$60	Medium	No	Capital
37 th Ave Sidewalks	Pedestrian	Fill in sidewalk gaps on both sides of street.	Lake Rd	Harrison St	\$870	Medium	No	Capital
Intersection Improvements at 42 nd Ave and King Rd	Pedestrian	Enhance intersection function.	Location-specific	Location-specific	\$20	Medium	No	Capital
Downtown Public Parking Lot Improvements	Parking	Upgrade and maintain off-street public parking facilities with improved landscaping and lighting.	Downtown	Downtown	\$60	Medium	No	Capital
Community Bicycle Rides	Bicycle	Support community bike rides to encourage bike use.	Citywide	Citywide	\$5	Medium	No	Operational

Project Name	TSP Chapter	Project Description	From	To	Estimated Cost (\$1,000s) ⁸	Priority Ranking ⁹	Is Project in Action Plan?	Project Type
Intersection Improvements at Harrison St and Hwy 224	Street	Add left-turn lanes and protected signal phasing on Harrison St approaches.	Location-specific	Location-specific	\$20	Medium	No	Capital
Cyclist Education	Bicycle	Promote bicycling through bike use and route selection education.	Citywide	Citywide	\$10	Medium	No	Operational
Harrison St Bike Lanes	Bicycle	Fill in gaps in existing bicycle network with bike lanes (cost included with Harrison St road widening project).	Hwy 99E	21 st Ave	\$300	Medium	No	Capital
Intersection Improvements at Linwood Ave and King Rd	Street	Implement protected/permissive left-turn phasing for northbound and southbound approaches.	Location-specific	Location-specific	\$20	Medium	No	Capital
Brookside Dr Sidewalks	Pedestrian	Fill in sidewalk gaps on both sides of street.	Johnson Creek Blvd	Regents Dr	\$20	Medium	No	Capital
Harrison St Capacity Improvements	Street	Widen to standard three lane cross section.	32 nd Ave	42 nd Ave	\$2,800	Medium	No	Capital
Intersection Improvements at Johnson Creek Blvd and Linwood Ave	Street	Add eastbound right-turn lane and westbound right-turn lane.	Location-specific	Location-specific	\$880	Medium	No	Capital
Logus Rd Sidewalks	Pedestrian	Fill in sidewalk gaps on both sides of street.	43 rd Ave	49 th Ave	\$850	Medium	No	Capital
Springwater Trail Completion	Pedestrian & Bicycle	Contribute to regional project to complete Springwater Trail ("Sellwood Gap") along Ochoco St.	17 th Ave	19 th Ave	\$90	Medium	No	Capital
Downtown Streetscape Improvements	Parking & Pedestrian	Install sidewalk bulbouts, lighting, and pedestrian amenities.	Downtown	Downtown	\$7,300	Medium	No	Capital
King Rd Boulevard Treatments	Pedestrian	Install street boulevard treatments: widen sidewalks and improve crossings.	43 rd Ave	Linwood	\$550	Medium	No	Capital
Bicycle and Pedestrian Overpass over Railroad Ave	Pedestrian & Bicycle	Establish a dedicated bicycle and pedestrian connection across Railroad Ave and the railroad tracks.	Railroad Ave	International Way	\$2,200	Medium	No	Capital
Oatfield Rd Bike Lanes	Bicycle	Fill in gaps in existing bicycle network with bike lanes.	Guilford Ct	Lake Rd	\$380	Medium	No	Capital
International Way Bicycle Facilities	Bicycle	Construct bike lanes or other bike facilities.	37 th Ave	Lake Rd	\$400	Medium	No	Capital
Traffic-Calming Improvements on River Rd at Lark St	Nbrhd Traffic Management	Install traffic-calming measures such as a permanent speed-warning sign and/or roundabout.	Location-specific	Location-specific	\$310	Medium	No	Capital
Bicycle/Pedestrian Improvements to Main St	Pedestrian & Bicycle	Construct multiuse path or other improved bike/ped facilities on Main St to provide safer connection between downtown and Tacoma station. (TSAP)	Hanna Harvester Dr	Tacoma station	\$2,900	Medium	No	Capital
Bicycle/Pedestrian Connection from Eastern Neighborhoods to Tacoma Station Area	Pedestrian & Bicycle	Establish bike/ped connection over existing railroad tracks and light rail to Tacoma station area. (TSAP)	Olsen St & Kelvin St	Mailwell Dr	\$4,000	Medium	No	Capital

Project Name	TSP Chapter	Project Description	From	To	Estimated Cost (\$1,000s) ⁸	Priority Ranking ⁹	Is Project in Action Plan?	Project Type
Improved Connection from Springwater Trail to McLoughlin Blvd	Pedestrian & Bicycle	Construct stairs or other facility to connect Springwater Trail to west side of McLoughlin Blvd. (TSAP)	Location-specific	Location-specific	\$500	Medium	No	Capital
Bicycle/Pedestrian Connection over Johnson Creek	Pedestrian & Bicycle	Construct bike/ped bridge over Johnson Creek along Clatsop St at 23 rd Ave to connect Tacoma station area with adjacent neighborhood. (TSAP)	Location-specific	Location-specific	\$400	Medium	No	Capital
Improved Bicycle/Pedestrian Connections on West Side of Tacoma Station Area	Pedestrian & Bicycle	Improve bike/ped connections to adjacent neighborhood to west of Tacoma station area at Ochoco St and Milport Rd. (TSAP)	Location-specific	Location-specific	\$500	Medium	No	Capital
LOW PRIORITY PROJECTS								
Railroad Ave Capacity Improvements	Street	Widen Railroad Ave to standard three lane cross section.	37 th Ave	Linwood Ave	\$14,200	Low	No	Capital
Ochoco St Sidewalks	Pedestrian	Construct sidewalks on Ochoco St to connect bus stops to Goodwill.	19 th Ave	McLoughlin Blvd	\$1,300	Low	No	Capital
Springwater Trail Intersection Improvements at 45 th Ave	Bicycle	Improve safety of crossing at intersection.	Location-specific	Location-specific	\$10	Low	No	Capital
Johnson Creek Blvd and 42 nd Ave Signalization	Street	Replace 3-way stop with signal when warranted.	Location-specific	Location-specific	\$270	Low	No	Capital
19 th Ave Sidewalks	Pedestrian	Fill in sidewalk gaps on both sides of street.	Kellogg Creek Trail	Sparrow St	\$330	Low	No	Capital
22 nd Ave Sidewalks	Pedestrian	Fill in sidewalk gaps on both sides of street.	McLoughlin Blvd	Sparrow St	\$360	Low	No	Capital
Edison St Sidewalks	Pedestrian	Fill in sidewalk gaps on both sides of street.	35 th Ave	37 th Ave	\$130	Low	No	Capital
Harvey St Sidewalks	Pedestrian	Fill in sidewalk gaps on both sides of street.	32 nd Ave	42 nd Ave	\$590	Low	No	Capital
Home Ave Sidewalks	Pedestrian	Fill in sidewalk gaps on both sides of street.	Railroad Ave	King Rd	\$830	Low	No	Capital
Johnson Creek Blvd Sidewalks	Pedestrian	Fill in sidewalk gaps on both sides of street.	Harney St	City limits	\$410	Low	No	Capital
Linwood Ave Sidewalks (north)	Pedestrian	Fill in sidewalk gaps on both sides of street.	Johnson Creek Blvd	King Rd	\$1,050	Low	No	Capital
Mason Lane Sidewalks	Pedestrian	Fill in sidewalk gaps on both sides of street.	42 nd Ave	Regents Dr	\$740	Low	No	Capital
Oatfield Rd Sidewalks	Pedestrian	Fill in sidewalk gaps on both sides of street.	Guilford Ct	City limits	\$150	Low	No	Capital
Regents Dr Sidewalks	Pedestrian	Fill in sidewalk gaps on both sides of street.	Brookside Dr	Winsor Dr	\$540	Low	No	Capital
Roswell St Sidewalks	Pedestrian	Fill in sidewalk gaps on both sides of street.	32 nd Ave	36 th Ave	\$210	Low	No	Capital
Rusk Rd Sidewalks	Pedestrian	Fill in sidewalk gaps on both sides of street.	Lake Rd	North Clackamas Park	\$730	Low	No	Capital
Olsen St Sidewalks	Pedestrian	Fill in sidewalk gaps on north side of street.	32 nd Ave	42 nd Ave	\$470	Low	No	Capital
49 th Ave Sidewalks	Pedestrian	Fill in sidewalk gaps on both sides of street.	Logus Rd	King Rd	\$270	Low	No	Capital
Hwy 224 Sidewalks	Pedestrian	Fill in sidewalk gaps on both sides of street.	Oak St	37 th Ave	\$460	Low	No	Capital

Project Name	TSP Chapter	Project Description	From	To	Estimated Cost (\$1,000s) ⁸	Priority Ranking ⁹	Is Project in Action Plan?	Project Type
Intersection Improvements at Olsen St and 42 nd Ave	Pedestrian	Improve pedestrian crossing.	Location-specific	Location-specific	\$20	Low	No	Capital
Intersection Improvements at Railroad and 37 th Aves	Pedestrian	Improve pedestrian crossing.	Location-specific	Location-specific	\$10	Low	No	Capital
Intersection Improvements at Stanley Ave and Logus Rd	Pedestrian	Improve pedestrian crossing.	Location-specific	Location-specific	\$20	Low	No	Capital
Pedestrian Connection to North Clackamas Park	Pedestrian	Create pedestrian connection between the school and the park.	Rowe Middle School	North Clackamas Park	\$1,400	Low	No	Capital
Intersection Improvements at Hwy 224 and 17 th Ave	Freight	Upgrade intersection turning radii to better accommodate freight movements.	Location-specific	Location-specific	\$60	Low	No	Capital
Intersection Improvements at Mailwell and Omark Drs	Freight	Upgrade intersection turning radii to better accommodate freight movements.	Location-specific	Location-specific	\$60	Low	No	Capital
Milwaukie Bike Map	Bicycle	Produce a Milwaukie Bike Map.	Citywide	Citywide	\$60	Low	No	Operational
Springwater Trail Signage	Bicycle	Install wayfinding signage for Springwater Trail.	Citywide	Citywide	\$20	Low	No	Capital
Intersection Improvements at Johnson Creek Blvd and Linwood Ave	Bicycle	Improve safety of crossing at intersection.	Location-specific	Location-specific	\$10	Low	No	Capital
Intersection Improvements at Linwood Ave and King Rd	Bicycle	Improve safety of crossing at intersection.	Location-specific	Location-specific	\$10	Low	No	Capital
Intersection Improvements at International Way and Lake Rd	Bicycle	Improve safety of crossing at intersection.	Location-specific	Location-specific	\$10	Low	No	Capital
Harrison St Bike Lanes	Bicycle	Fill in gaps in existing bicycle network with bike lanes.	Hwy 224	42 nd Ave	\$10	Low	No	Capital
37 th Ave Bike Lanes	Bicycle	Fill in gaps in existing bicycle network with bike lanes.	Harrison St	Hwy 224	\$3,200	Low	No	Capital
43 rd Ave Bike Lanes	Bicycle	Fill in gaps in existing bicycle network with bike lanes.	King Rd	Filbert St	\$1,100	Low	No	Capital
Linwood Ave Bike Lanes (north)	Bicycle	Fill in gaps in existing bicycle network with bike lanes.	Queen Rd	Johnson Creek Blvd	\$1,900	Low	No	Capital
Linwood Ave Bike Lanes (south)	Bicycle	Fill in gaps in existing bicycle network with bike lanes.	Juniper St	Harmony Rd	\$320	Low	No	Capital
Rusk Rd Bike Lanes	Bicycle	Fill in gaps in existing bicycle network with bike lanes.	Lake Rd	North Clackamas Park	\$1,000	Low	No	Capital
Police Enforcement on Drivers	Bicycle	Enforce laws related to bike lanes and bicycle safety.	Citywide	Citywide	\$10	Low	No	Operational
Bike Lane Striping	Bicycle & Transit	Restripe existing bike lanes and stripe bike lanes on streets where buses and bicyclists share the road.	Citywide	Citywide	\$20	Low	No	Operational

Project Name	TSP Chapter	Project Description	From	To	Estimated Cost (\$1,000s) ⁸	Priority Ranking ⁹	Is Project in Action Plan?	Project Type
Kellogg Creek Trail Improvements	Bicycle	Resurface trail and provide wayfinding signage to/from trail.	Milwaukie Riverfront	Treatment Plant	\$680	Low	No	Capital
Hwy 224 Access Modifications at Freeman Way	Street	Modify access at Freeman Way to improve intersection functioning.	Location-specific	Location-specific	\$1,400	Low	No	Capital
Washington St Sidewalks	Pedestrian	Fill in sidewalk gaps on both sides of street.	32 nd Ave	35 th Ave	\$130	Low	No	Capital
Franklin St Sidewalks	Pedestrian	Install sidewalks on both sides of street to connect to Campbell Elementary School.	42 nd Ave	45 th Ave	\$220	Low	No	Capital
Intersection Improvements at 42 nd Ave and Harrison St	Street	Signalize intersection to facilitate dominant traffic flow.	Location-specific	Location-specific	\$280	Low	No	Capital
Pedestrian Walkway Signage	Pedestrian	Provide maps and wayfinding signage on streets that identify ways to get around the city.	Citywide	Citywide	\$10	Low	No	Operational
Lake Rd Capacity Improvements	Street	Widen to standard three lane cross section.	21 st Ave	Oatfield Rd	\$8,100	Low	No	Capital
Intersection Improvements at all Crossings of McLoughlin Blvd	Pedestrian	Improve all existing crossings of McLoughlin Blvd (e.g., extended time for crossing, signage). (ODOT to do.)	Location-specific	Location-specific	—	Low	No	Capital
Bike/Ped Path on Sparrow St	Pedestrian & Bicycle	Establish a dedicated bicycle and pedestrian connection on Sparrow St, connecting River Rd to Trolley Trail	River Rd	Trolley Trail	\$350	Low	No	Capital
Bike/Ped Overpass over McLoughlin Blvd at River Rd	Pedestrian & Bicycle	Establish a dedicated bicycle and pedestrian connection across McLoughlin Blvd.	Kronberg Park	River Rd	\$2,500	Low	No	Capital
Intersection Improvements at 42 nd Ave and King Rd	Street	Realignment of intersection to improve traffic movements between 42 nd Ave and King Rd east of 42 nd Ave.	Location-specific	Location-specific	\$200	Low	No	Capital
Traffic-Calming on lower King Rd	Nbrhd Traffic Management	Install traffic-calming measures on King Rd.	36 th Ave	42 nd Ave	\$300	Low	No	Capital
Improved Connection from Springwater Trail to Pendleton Site (Tunnel)	Pedestrian & Bicycle	Construct tunnel under Springwater Trail to improve connection to Pendleton site at Clatsop St. (TSAP)	Location-specific	Location-specific	\$1,200	Low	No	Capital
Crossing Improvements for McLoughlin Blvd at Ochoco St and Milport Rd	Pedestrian & Bicycle	Construct improvements at Ochoco St and Milport Rd to improve bike/ped crossing of McLoughlin Blvd (per ODOT, this will require full intersection improvements). (TSAP)	Location-specific	Location-specific	\$8,320	Low	No	Capital
Local Street Connections in Tacoma Station Area	Street	Connect local streets within Tacoma station area: 24 th Ave between Ochoco St/Moores St & Clatsop St; Omark St between Mailwell Dr & Beta St (w/ midblock connection from Main St); and Mailwell Dr to Harrison St via 26 th Ave. (TSAP)	Location-specific	Location-specific	\$8,120	Low	No	Capital
Local Street Improvements in Tacoma Station Area	Street	Construct street improvements on Stubb St, Beta St, Ochoco St, Hanna Harvester Dr, and Mailwell Dr. (TSAP)	Location-specific	Location-specific	\$5,280	Low	No	Capital

Project Name	TSP Chapter	Project Description	From	To	Estimated Cost (\$1,000s) ⁸	Priority Ranking ⁹	Is Project in Action Plan?	Project Type
Bicycle/ Pedestrian Connection between McLoughlin Blvd and Stubb St	Pedestrian & Bicycle	Establish bike/ped connection to McLoughlin Blvd sidewalk at west end of Stubb St. (TSAP)	Location-specific	Location-specific	\$20	Low	No	Capital
REGIONAL PROJECTS WITHIN OR THROUGH THE CITY OF MILWAUKIE¹⁰								
Oregon City Light Rail Extension or High Capacity Transit Improvements	—	Construct light rail or high capacity transit improvements between Milwaukie and Oregon City.	Milwaukie Town Center	Oregon City	\$577,500	—	No	Capital
North Clackamas Greenway Corridor Study	—	Study feasibility of corridor for multiuse path construction (possibly along Kellogg Creek).	Milwaukie	Clackamas Regional Center	—	—	No	Capital
Linwood/Harmony /Lake Rd Intersection Improvements	Freight & Street	Add northbound right-turn lane and eastbound right-turn lane. AND/OR Grade separate Harmony Rd from Union Pacific Railroad and align as a through east-west movement.	Location-specific	Location-specific	\$30,700	—	No	Capital
McLoughlin Blvd Improvements	—	Complete boulevard design improvements.	Scott St	Harrison St	\$3,300	—	No	Capital
Tillamook Branch Trestle Trail Study	—	Study feasibility of east-west multiuse trail construction.	Milwaukie Town Center	Lake Oswego Town Center	—	—	No	Capital
Railroad Junction Improvements	—	Implement track and signal improvements to allow for increased track speeds between UP Willsburg Junction and UP Albina Yards.	Milwaukie	UP Railroad Albina Yards	\$8,800	—	No	Capital
Railroad Track Extension	—	Extend two tracks from Willsburg Junction to Clackamas.	Milwaukie	I-205	\$19,000	—	No	Capital
Tualatin-Portland Commuter Rail Extension Study	—	Study feasibility of adding peak-hour-only service on existing tracks.	Tualatin	Union Station via Lake Oswego & Milwaukie	TBD	—	No	Operational
Pedestrian Overcrossing of McLoughlin Blvd at Umatilla St	—	Construct bike/ped overcrossing of McLoughlin Blvd at Umatilla St. (TSAP)	Location Specific	Location Specific	\$2,200	—	No	Capital
Portland Bike-Share Station and Car Share Spaces at Tacoma Station	—	Establish a Portland Bike-Share station and car-share spaces at Tacoma station. (TSAP)	Location Specific	Location Specific	\$70	—	No	Capital

Key:

NDA = Neighborhood District Association
 NTMP = Neighborhood Traffic Management Program
 CIP = Capital Improvement Program
 STSP = Safe Trips to School Program
 RTP = Regional Transportation Plan
 TSAP = Tacoma Station Area Plan

¹⁰ 2004 Regional Transportation Plan (RTP) projects in the Milwaukie area that may or may not be shown on mode-specific master plans or project lists.



14

Transportation Planning Rule Implementation

The purpose of this chapter is to provide an overview of recommended changes to the Milwaukie Municipal Code with the objective of complying with Oregon's Transportation Planning Rule (TPR) and Metro's Regional Transportation Plan (RTP).

OREGON TRANSPORTATION PLANNING RULE OVERVIEW

The Oregon Transportation Planning Rule ("TPR", or Oregon Administrative Rule Chapter 660, Division 12) requires local governments to implement a transportation system plan that is supported by local land use regulations. The rule sets requirements to protect transportation facilities and enhance pedestrian and bicycle travel.

TPR requirements are fairly broad and allow local governments flexibility in how they comply with the rule. For example, OAR 660-012-0045(2)(b) requires local governments to "protect transportation facilities . . . for their identified functions." The TPR does not define a standard to protect a facility or restrict local governments from self-identifying the function of their facilities.

TPR rules for ODOT-regulated facilities, such as Oregon State Highways 99E and 224, are more restrictive and are regulated by the State in coordination with the City. State, regional, and County facilities within the city are regulated by the respective owner of the facility but are also subject to City regulations.

The Milwaukie Municipal Code has been periodically updated to comply with the TPR, with the most recent updates occurring in 1994, 2002, and 2007. No comprehensive plan or Zoning Ordinance amendments are recommended as part of the 2013 TSP update.

Appendix A

Neighborhood Information

PURPOSE

Per public request for transportation information tailored to each Neighborhood District Association (NDA), all of the master plan figures were modified to include NDA boundaries in addition to the transportation conditions and proposed improvements.

The following maps are included in this appendix:

- Figure A-1: Pedestrian Master Plan with Neighborhood Boundaries
- Figure A-2: Bicycle Master Plan with Neighborhood Boundaries
- Figure A-3: Public Transit Master Plan with Neighborhood Boundaries
- Figure A-4: Street Network Master Plan with Neighborhood Boundaries
- Figure A-5: Freight Master Plan with Neighborhood Boundaries

These specific figures were selected because they depict both existing facilities and proposed improvements for each element, so they provide a comprehensive picture of the transportation environment of each neighborhood. These maps can be used to identify projects that impact a specific neighborhood and facilitate discussion about neighborhood transportation priorities.



Transportation System Plan

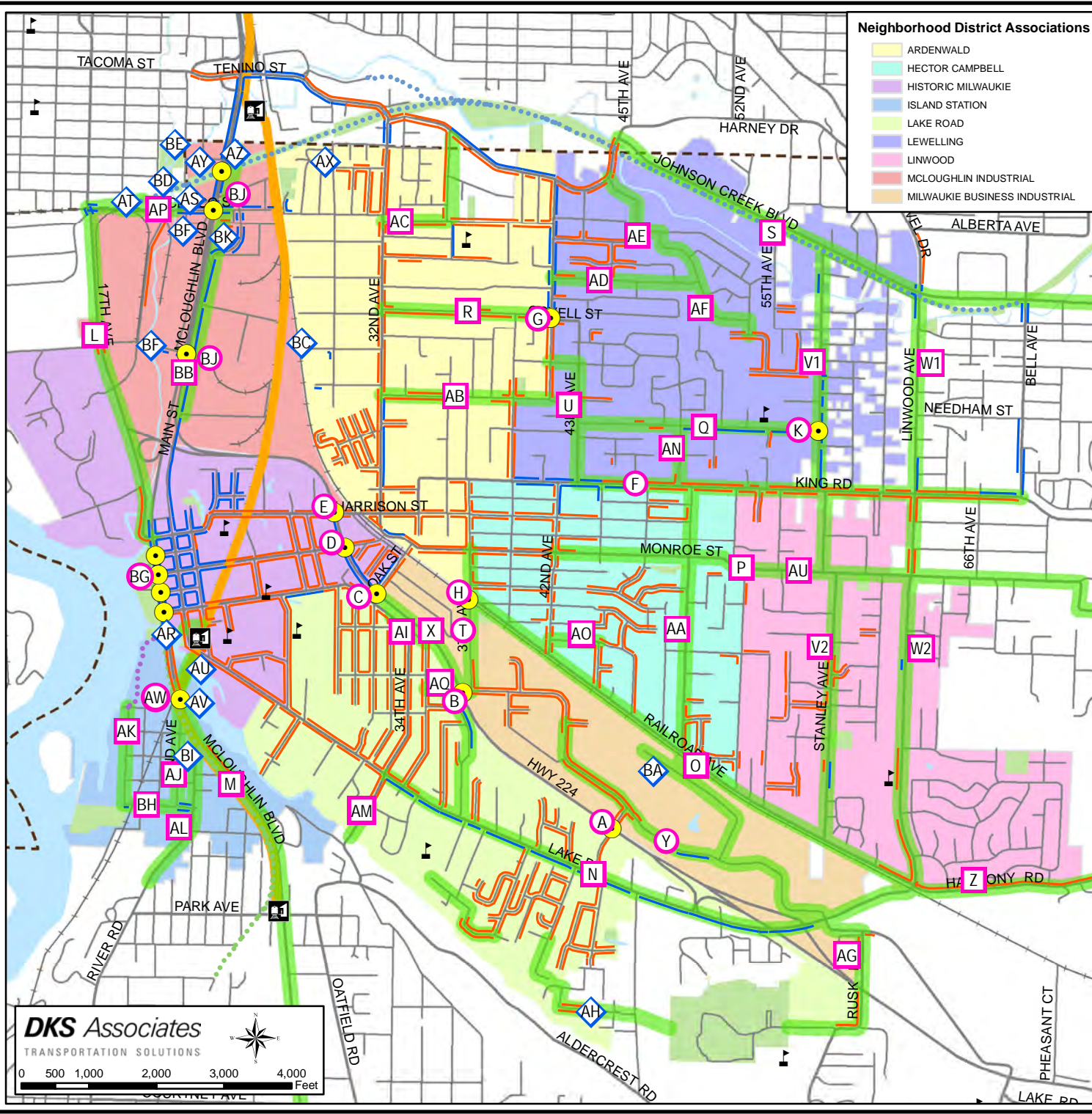
FIGURE A-1

PEDESTRIAN MASTER PLAN

November 2013

Neighborhood District Associations

- ARDENWALD
- HECTOR CAMPBELL
- HISTORIC MILWAUKIE
- ISLAND STATION
- LAKE ROAD
- LEWELLING
- LINWOOD
- McLOUGHLIN INDUSTRIAL
- MILWAUKIE BUSINESS INDUSTRIAL



LEGEND

Existing Sidewalks

- < 5 ft width
- 5 ft - 10 ft width
- Kellogg Creek Trail
- Springwater Trail
- Trolley Trail

Proposed Improvement

- Pedestrian Intersection Safety Improvement
- Pedestrian Facilities

- ▲ Schools
- Water
- Major Roads
- Parks
- Streets
- Light Rail Transit
- Railroad
- Light Rail Station
- County Line

PROPOSED PROJECTS

Improve Intersection to Increase Pedestrian Safety

- (A) Freeman Way/HWY 224
- (B) 37th Ave/HWY 224
- (C) Oak St/HWY 224
- (D) Monroe St/HWY 224
- (E) Harrison St/HWY 224
- (F) King Rd improvements
- (G) Olsen St/42nd Ave
- (H) Railroad Ave/37th Ave
- (K) Stanley Ave/Logus Rd
- (AV) McLoughlin Blvd and 22nd Ave
- (BG) All McLoughlin crossings
- (BJ) McLoughlin and Ochoco/Milport

Provide Pedestrian Facilities Where Not Currently Present
See Table 5-1 for project descriptions L-AG, AI-AO, BB, BH

Enhance Existing Pedestrian Connection

- (AI) Create ped connection from Rowe Middle School to North Clackamas Park
- (AR) Construct pedestrian underpass under HWY 99E at Kellogg Creek
- (AS) Improve ramp at Springwater Trail/HWY 99E
- (AT) Complete Springwater Trail along Ochoco St
- (AU) Construct bike-ped overpass over Kellogg Creek
- (AV) Construct Kronberg Park Trail
- (AY) Pave connection to Springwater Trail at 29th Ave and Sharrett
- (AZ) Improve connection from Springwater Corridor to Pendleton Site
- (AZ) Construct stairs to connect Springwater Corridor to LRT Station
- (BA) Establish bike-ped connection across Railroad Ave and tracks
- (BC) Establish bike-ped connection over railroad tracks and LRT
- (BD) Construct stairs to connect Springwater Corridor to McLoughlin
- (BE) Construct bike-ped bridge over Johnson Creek along Clatsop at 23rd Ave to connect to LRT station
- (BF) Improve bike-ped connection to neighborhoods west of station
- (BI) Establish bike-ped connection over McLoughlin at River Rd
- (BK) Establish bike-ped connection to McLoughlin at Stubb St

DKS Associates

TRANSPORTATION SOLUTIONS



0 500 1,000 2,000 3,000 4,000 Feet



Transportation System Plan

FIGURE A-2

BICYCLE MASTER PLAN

November 2013

LEGEND

Existing Bicycle Facilities

- Shared Lane
- Bicycle Lane
- Kellogg Creek Trail
- Springwater Trail
- Trolley Trail

Proposed Improvements

- Bicycle Intersection Safety Improvement
- Bicycle Lanes
- Neighborhood Greenway

- Schools
- Major Roads
- Streets
- Railroad
- 10' Contours
- County Line
- Water
- Parks
- Light Rail Station
- Light Rail Transit

PROPOSED PROJECTS

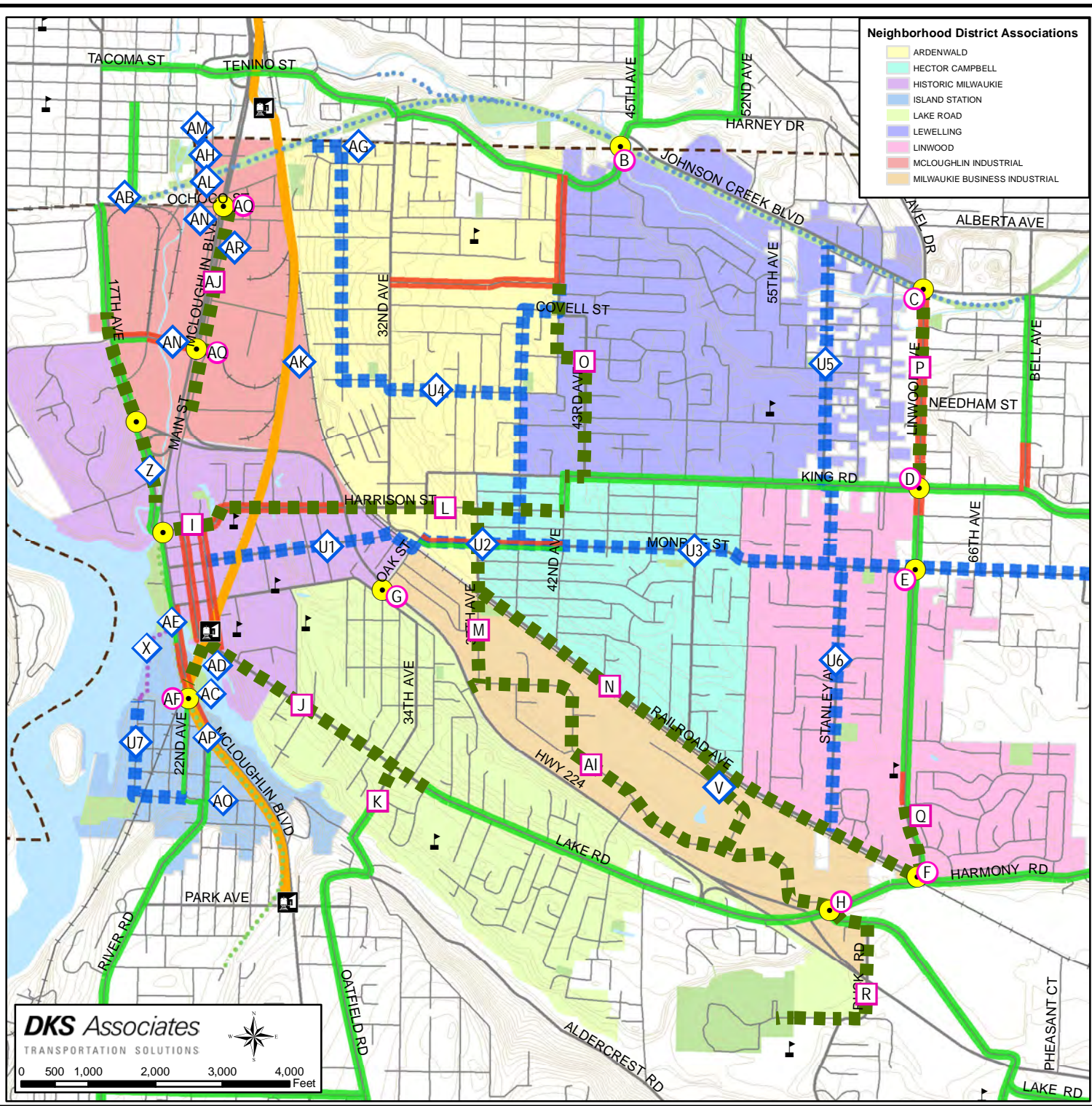
- Improve Intersection to Increase Bicycle Safety*
- A Adams St/21st Ave/Railroad Crossing
 - B Johnson Creek Blvd/Springwater Trail
 - C Johnson Creek Blvd/Linwood Ave
 - D Linwood Ave/King Rd
 - E Linwood Ave/Monroe St
 - F Linwood Ave/Harmony Rd
 - G Washington St/Oak St/Hwy 224
 - H International Way/Lake Rd
 - I McLaughlin and 22nd
 - J McLaughlin/Ochoco/Milport

Provide Bicycle Lanes Where Not Currently Present
See Table 6-2 for project descriptions B-R, AI, and AJ

- Enhance Existing Bicycle Connection*
- U1 Install Neighborhood Greenway treatments at various locations
 - V Construct bicycle overpass from Railroad Ave to International Way
 - W Improve Springwater Trail paving
 - X Improve Kellogg Creek Trail
 - Y Install Trolley Trail signage
 - Z Fill in gaps in existing bike network with bike lanes or multiuse path
 - AA Improve intersection safety on 17th Ave at Hwy 224 and at 99E
 - AB Improve ramp at Springwater Trail/Hwy 99E
 - AC Complete Springwater Trail along Ochoco St
 - AD Construct Kronberg Park Trail
 - AE Construct bike-ped overpass over Kellogg Creek
 - AF Construct pedestrian underpass under Hwy 99E at Kellogg Creek
 - AG Pave connection to Springwater Trail at 29th Ave and Sharrett
 - AH Improve connection from Springwater Corridor to Pendleton Site
 - AI Establish bike-ped connection over railroad tracks and LRT
 - AJ Construct stairs to connect Springwater Corridor to McLaughlin
 - AK Construct bike-ped bridge over Johnson Creek along Clatsop at 23rd Ave to connect to LRT station
 - AL Improve bike-ped connection to neighborhoods west of station
 - AO Establish bike-ped path on Sparrow to connect River Rd to Trolley Trail
 - AP Establish bike-ped connection over McLaughlin at River Rd
 - AR Establish bike-ped connection to McLaughlin at Stubb St

Neighborhood District Associations

- ARDENWALD
- HECTOR CAMPBELL
- HISTORIC MILWAUKIE
- ISLAND STATION
- LAKE ROAD
- LEWELLING
- LINWOOD
- M'CLOUGHLIN INDUSTRIAL
- MILWAUKIE BUSINESS INDUSTRIAL



DKS Associates
TRANSPORTATION SOLUTIONS

0 500 1,000 2,000 3,000 4,000 Feet



Transportation System Plan

FIGURE A-3

PUBLIC TRANSIT MASTER PLAN

November 2013

LEGEND

Existing Facilities

- Bus Route Number
- Bus Stop
- Park and Ride
- Light Rail Station
- Bus Route
- Light Rail Transit

Proposed Improvements

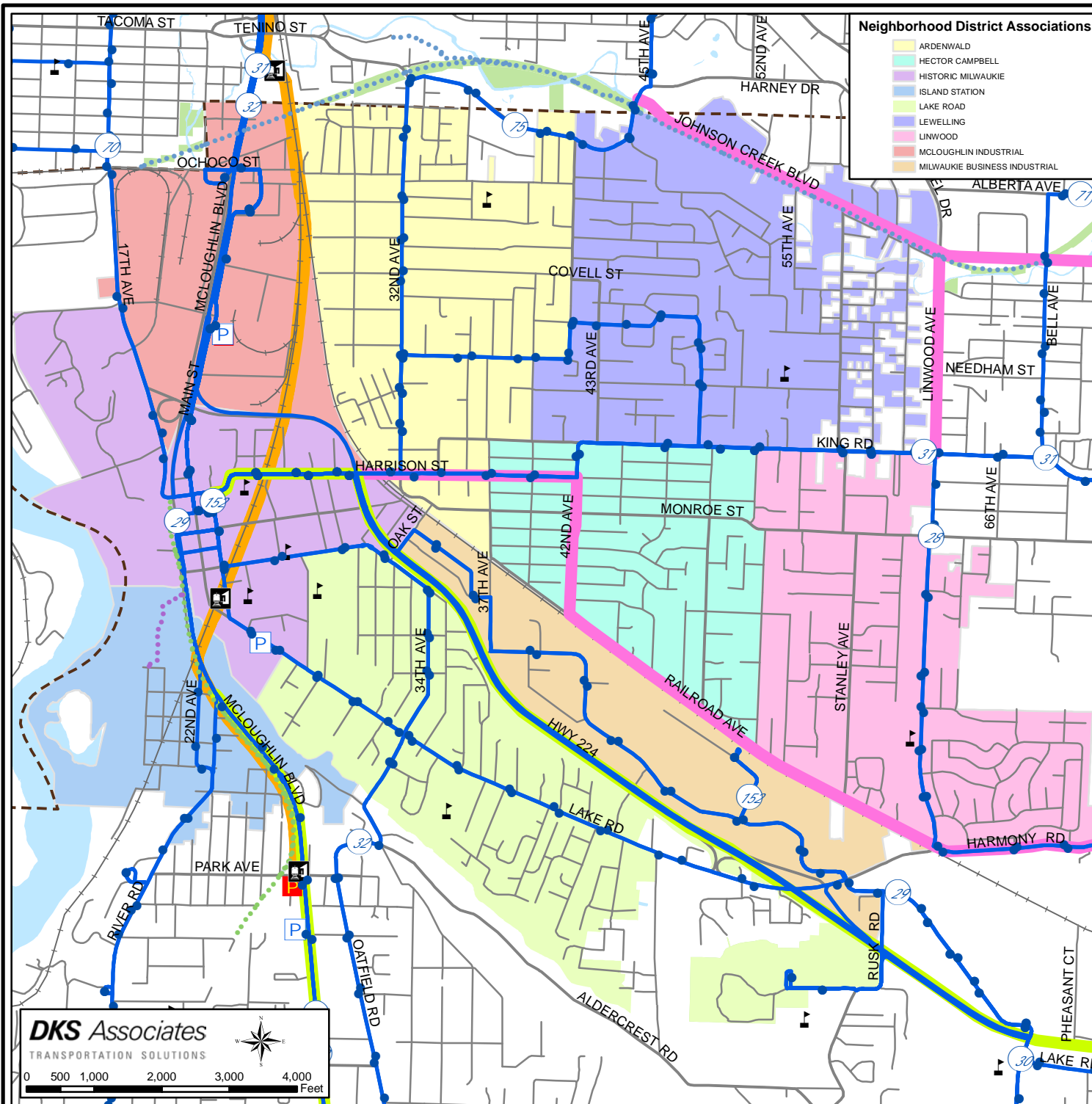
- Park and Ride
- New or Rerouted Bus Route
- Bus Rapid Transit Route

Other Map Features

- Schools
- Major Roads
- Streets
- Railroad
- Kellogg Creek Trail
- Springwater Trail
- Trolley Trail
- County Line
- Water
- Parks
- City Limits

Neighborhood District Associations

- ARDENWALD
- HECTOR CAMPBELL
- HISTORIC MILWAUKIE
- ISLAND STATION
- LAKE ROAD
- LEWELLING
- LINWOOD
- MCLOUGHLIN INDUSTRIAL
- MILWAUKIE BUSINESS INDUSTRIAL



DKS Associates

TRANSPORTATION SOLUTIONS



0 500 1,000 2,000 3,000 4,000 Feet



Transportation System Plan

FIGURE A-4

STREET NETWORK MASTER PLAN

November 2013

LEGEND

- Proposed Street Network Improvements**
- Travel Route Improvement
 - Roadway Widening Project
 - Corridor Refinement Plan
 - Intersection Improvement

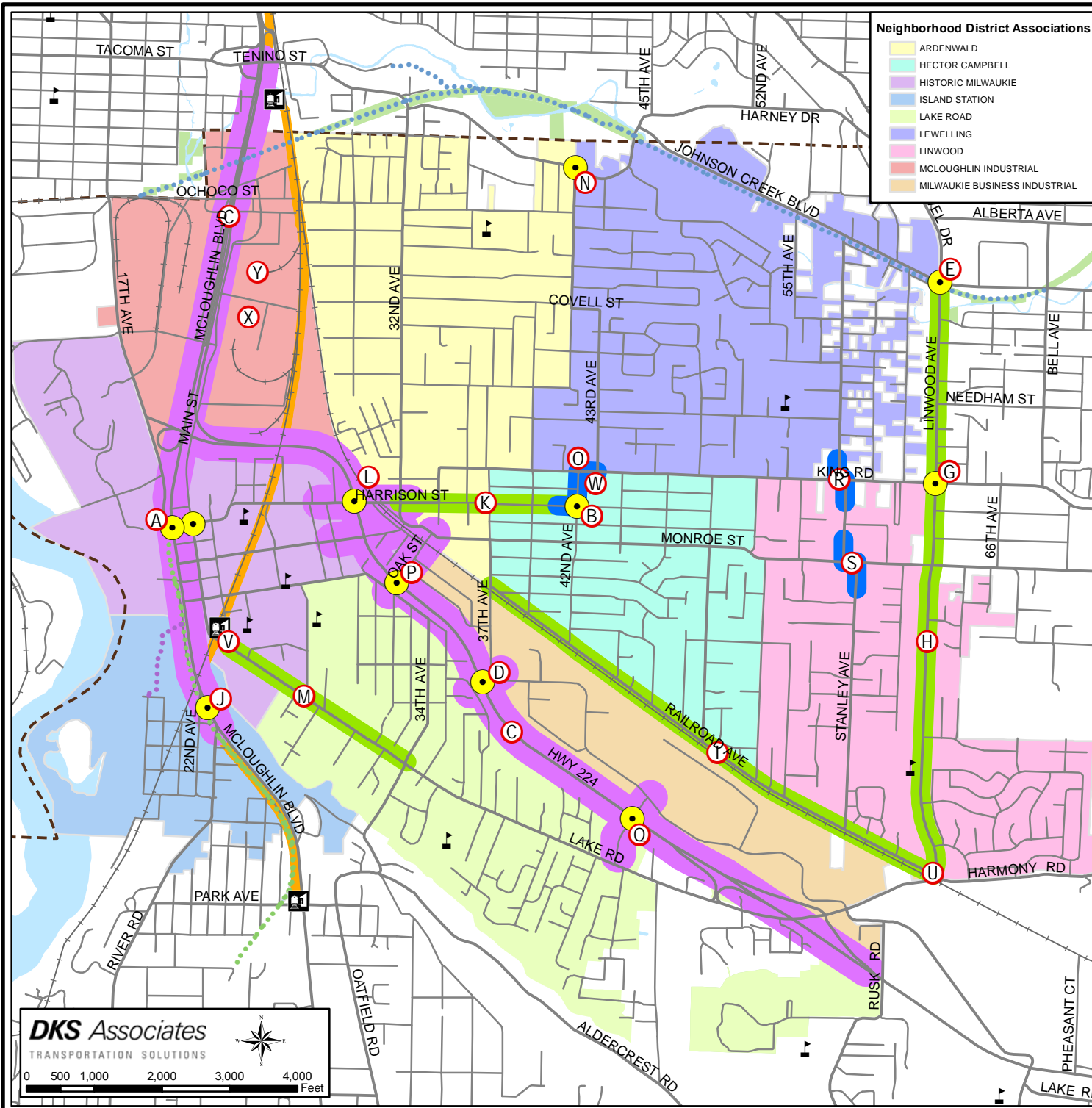
- Schools
- Light Rail Station
- Light Rail Rapid Transit
- Kellogg Creek Trail
- Springwater Trail
- Trolley Trail
- Major Roads
- Streets
- Railroad
- County Line
- Water
- Parks

PROPOSED PROJECTS

- A** Prohibit left turn movement at 17th Ave/McLoughlin Blvd and include in Refinement Plan
- B** Signalize Harrison St/42nd Ave
- C** Conduct Refinement Plan for HWY 99E/HWY 224 focused on motor vehicle and freight mobility.
 - HWY 99E Project Limits: Tacoma St to 17th Ave
 - HWY 224 Project Limits: HWY 99E to Lake Rd Interchange
- D** Reconfigure intersection to consolidate 37th Ave/Industrial Way
- E** Add eastbound/westbound right turn lanes and integrate the trail crossing
- F** Create westbound shared through/right lane: or Add eastbound right turn pocket
- G** Implement protected/permitted phasing for northbound and southbound left turns
- H** Widen Linwood Ave to standard three lane cross section
- I** Widen Railroad Ave to standard three lane cross section
- J** Redesign Intersections of River Rd and 22nd Ave to consolidate intersections: or Add northbound left turn pocket on River Rd
- K** Widen Harrison St to standard three-lane cross section
- L** Add left turn-lanes and protected signal phasing on Harrison St approaches
- M** Widen Lake Rd to standard three-lane cross section
- N** Replace 3-way stop with signal when warranted and appropriate. (Coordinate with the City of Portland)
- O** Enhance connection between King Rd and Harrison St
- P** Add protected signal phasing on Oak St approaches
- Q** Improve intersection/modify access at HWY 224 and Freeman Way
- R** Enhance connection along Stanley Ave at King Rd
- S** Enhance connection along Stanley Ave at Monroe St
- V** Improve safety of Trolley Trail crossing at 22nd Ave
- W** Realign intersection to improve traffic between 42nd Ave and King Rd east of 42nd Ave
- X** Connect local streets within Tacoma Station Area (see Fig 8-4)
- Y** Construct street improvements on Stubbs St, Beta St, Ochocho St, Hanna Harvester Dr and Mailwell Dr (TSAP)

Neighborhood District Associations

- ARDENWALD
- HECTOR CAMPBELL
- HISTORIC MILWAUKIE
- ISLAND STATION
- LAKE ROAD
- LEWELLING
- LINWOOD
- McLOUGHLIN INDUSTRIAL
- MILWAUKIE BUSINESS INDUSTRIAL



DKS Associates

TRANSPORTATION SOLUTIONS



0 500 1,000 2,000 3,000 4,000 Feet



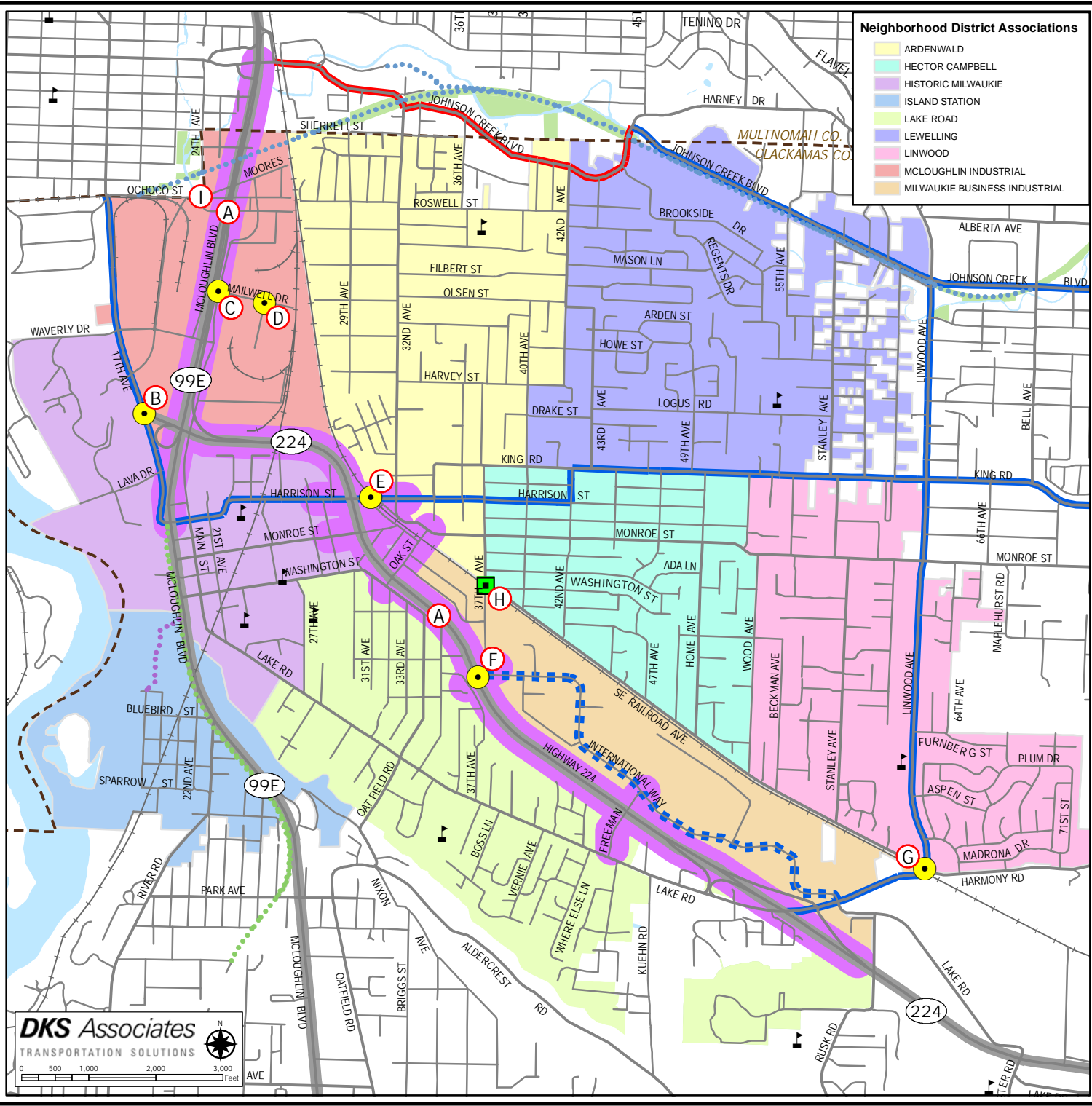
Transportation System Plan

FIGURE A-5

FREIGHT MASTER PLAN November 2013

Neighborhood District Associations

- ARDENWALD
- HECTOR CAMPBELL
- HISTORIC MILWAUKIE
- ISLAND STATION
- LAKE ROAD
- LEWELLING
- LINWOOD
- MCLOUGHLIN INDUSTRIAL
- MILWAUKIE BUSINESS INDUSTRIAL



LEGEND

Existing Freight Routes	Proposed Improvements
Major Regional	Intersection Improvement
Minor Preferred (Local)	Intersection Material Upgrade
Weight Restricted Minor Preferred (Local)	Corridor Refinement Plan
Minor Preferred Freight Route (Local)*	Minor Preferred Freight Route (Local)*
Major Roads	County Line
Streets	Parks
Railroad	Water
Springwater Trail	
Kellogg Creek Trail	
Trolley Trail	

PROPOSED PROJECTS

- Improve Corridor**
- A** Conduct Refinement Plan for HWY 99E/HWY 224 focused on motor vehicle and freight mobility.
 - HWY 99E Project Limits: Tacoma St to 17th Ave
 - HWY 224 Project Limits: HWY 99E to Lake Rd Interchange
- Improve Intersection**
- B** 17th Ave/HWY 224 Upgrade intersection turning radii to better accommodate freight movements
 - C** Main St/Mailwell Dr Upgrade intersection turning radii to better accommodate freight movements
 - D** Mailwell Dr/Omark Dr Upgrade intersection turning radii to better accommodate freight movements
 - E** Harrison St/Union Pacific Railroad Crossing Upgrade crossing to grade separated facility (outcome of crossing dependant upon 99E/224 Refinement Plan findings)
 - F** HWY 224/37th Ave Consolidate two northern legs of 37th Ave and Industrial Way into one leg at HWY 224.
 - G** Linwood/Harmony/Lake Road Intersection Improvements Add northbound right turn lane and eastbound right turn lane AND/OR grade separate Harmony Road from Union Pacific Railroad and align as a through east-west movement
 - H** Railroad Crossing Improvements at 37th Ave Improve road transition to railroad crossing
 - I** Signage and Intersection Improvements at McLoughlin Boulevard and Ochoco St. Establish signage for trucks and improve intersection (TSAP)

DKS Associates
TRANSPORTATION SOLUTIONS

0 500 1,000 2,000 3,000 Feet

Appendix B

Public Involvement Summary

Archival Note: Appendix B was created as part of the 2007 TSP update—it does not reflect the update process that was conducted in 2013.

INTRODUCTION

Milwaukie has some of the most organized and active communities, neighborhoods and citizen activists in the Portland Metro area. Residents have a high expectation to be involved in City business. Recognizing this, the City developed a public involvement program that was likely the most extensive public outreach and involvement process-to-date in the State of Oregon for a Transportation System Plan (TSP). The program included opportunities for citizens to participate at both a mode-specific and broad policy level, resulting in a TSP that reflects the needs and priorities of the community.

POLICY REQUIREMENTS

State, regional, and City policies require that citizen input be part of the transportation system planning process. Oregon's Statewide Planning Goal #1 mandates the following:

- Provide widespread citizen involvement, including the establishment of a citizen advisory committee (CAC) broadly representative of geographic areas and interests.
- Assure effective two-way communication with citizens.
- Assure technical information is available in an understandable form.
- Assure that citizens receive a response from policymakers.
- Ensure adequate funding for citizen involvement in a planning budget.

As outlined in the Comprehensive Plan Chapter 1, City policy requires the following:

- **Objective #1:** "The City will promote citizen participation in the planning process primarily through the nine Milwaukie Neighborhood Areas..."
- **Objective #2:** "To encourage broadly based public participation involving a cross section of citizens from a variety of geographic and interest areas, solicited through an open, well-publicized process."
- **Objective #3:** "Promote informed public participation in planning decisions by providing readily available publications and printed materials regarding current issues and proposed policies and providing for two-way communication between policy-makers and citizens."

OUTREACH AND INVOLVEMENT PROGRAM

At the beginning of the TSP Update Project the City set the following goal:

The public involvement process for the Milwaukie TSP update will encourage and provide opportunities for citizens to participate in all phases of the planning process and keep

citizens informed through open lines of communication for the sharing of questions, problems and suggestions.

To reach this goal, staff designed the TSP public outreach and involvement program to include the following elements:

- Community Briefings
- Advisory Committee
- Working Groups
- Web Survey
- Open Houses
- Information

Community Briefings

The City hosted four Community Briefings in different locations around Milwaukie between November 30 and December 6, 2006 to:

- Introduce and describe the TSP and the TSP update process.
- Invite future participation in upcoming Working Groups and Workshops.
- Solicit public input in a focused way on existing conditions and key issues.
- Inform the public about how to stay updated on TSP news and events.

The City Planning Director began each two-hour Community Briefing with a short slide show presentation explaining the TSP project and process. Participants were invited to write their concerns, questions, or statements about what the City should study during the TSP process. Posters in the room provided information about involvement opportunities, and participants were invited to indicate their interest in upcoming working groups and workshops.

Community Briefings were widely advertised:

- A special 2-page insert was featured in the November 2006, Pilot and sent to every household in Milwaukie (about 8,000 households).
- Flyers were hand-delivered to every business in downtown Milwaukie.
- The *Oregonian*, *Clackamas Review*, and North Clackamas School District newsletter listed the briefings in their calendars and ran short stories.
- The City's Transportation Liaison notified parent-teacher groups, local churches, and other interested individuals.
- The Community Services Department announced the Community Briefings in weekly e-mail updates to interested citizens.

Advisory Committee

The City formed the TSP Advisory Committee (AC) by inviting appointed representatives and also advertising an open application process. The group included representatives of partner agencies and local businesses, as well as interested citizens (there was at least one resident of each Neighborhood District Association). The AC met six times between January and August 2007. All of these meetings were advertised in advance and open to the broader



Advisory Committee members discuss TSP goals

community, and meeting packets were available on the City's website.

The AC meetings were well attended, with an average attendance of 20 people at each meeting. AC members contributed over thirty hours of their time participating in meetings and reviewing materials in advance. In addition, many of the AC members each participated in one or more Working Groups, Workshops, and Open Houses.

The AC was instrumental in developing the City's transportation goals, identifying new or revised policies, reviewing and consolidating the recommendations from the working groups, and guiding project prioritization. Exit surveys conducted with the AC members indicate that the participants were highly satisfied with the process.

City of Milwaukie Transportation System Plan Update Advisory Committee Members*

Citizen Representatives	
David Aschenbrenner	Citizen Member (Hector Campbell)
Scott Churchill	Citizen Member (Historic Milwaukie)
Nick Dougher	Citizen Member (Linwood)
Forris Frick	Citizen Member (Lake Road)
Ben Horner-Johnson	Citizen Member (Lake Road)
Michole Jensen	Citizen Member (Ardenwald)
Paul Klein	Citizen Member (Lewelling)
Dolly Macken-Hambright	Citizen Member (Linwood)
Charlie Stephens	Citizen Member (Oak Grove)
Ed Zumwalt	Citizen Member (Historic Milwaukie)
Business Representatives	
Greg Chaimov	Chamber of Commerce Representative
Neil Hankerson	Downtown Business Representative
Gary Hunt	Industrial Business Representative
Bill Lake	Industrial Business Representative
Todd E. Mobley	Hospital Representative
Mike Wells	Real Estate Development Representative
Agency Representatives	
Kelly Carlisle	School District Representative
Gail Curtis	ODOT Contract Manager
Shari Gilevich	Clackamas County Representative
Marty Hanley	Milwaukie Center Representative
Stacy Humphrey & Bill Holmstrom	State of Oregon DLCD Representative
John Mermin	Metro Representative
Young Park	TriMet Representative
Ron Schumacher / Mace Childs	Fire Department Representatives
Mike Swanson / Kenny Asher	City of Milwaukie Representatives

* Members are defined as having submitted an application and participated in at least three of the six meetings.

Working Groups and Workshops

The Working Groups and Workshops were created to focus on different subtasks of the TSP. The Working Groups included; Downtown Parking, Freight, Street Design, Traffic and Street Network, and Transit. The Workshops included; Bike and Pedestrian. The introduction of Working Groups and Workshops into the planning process allowed for specific aspects of the TSP to be discussed and resolved to a greater level of detail than usually occurs at the TSP level providing valuable policy and project direction. The City was faced with several areas of their transportation system that either were minimally addressed in the previous TSP (such as bicycle/pedestrian planning and street design), required innovative solutions (such as freight), and/or were complicated or historically unresolved (such as transit and downtown parking).



Street Design participants discuss "context sensitive" design options

Community members, businesses, and participants in the Advisory Committee were invited to join one or more mode-specific Working Groups or attend a Workshop on specific transportation issues. Anyone who was interested in participating attended an orientation meeting in February 2007, which outlined the overall process and opportunities for involvement. The orientation event was taped and televised on Milwaukie Cable Access channel 30 throughout the months of February and March 2007.

Each Working Group met three or four times each with many participants involved in several groups. Workshops met two to three times each to discuss pedestrian and bike solutions as well as downtown parking. In total there were:



The TSP Bicycle Solutions group takes a bike tour through Milwaukie

- Two Pedestrian workshops
- Three Bike workshops--including a guided bike tour
- Two Downtown Parking workshops
- Four Freight Access meetings
- Four Traffic & Auto Circulation Solutions meetings
- Three Street Design Alternatives meetings
- Four Transit Solutions meetings

Over one hundred people participated in the Working Groups and Workshops. The focused nature of the Working Groups and Workshops allowed for a greater level of technical detail to be presented and discussed. Many working group members contributed countless hours reviewing existing conditions, identifying problems, developing innovative solutions, proposing policy changes and recommendations, and establishing both community and modal priorities. Each Working Group and Workshop created a draft "modal plan," which was brought to the Advisory Committee to be compiled into one set of citywide priorities. While time consuming and at times complicated for the staff to implement, the Working Groups and Workshops were well received by the community and proved to be an extremely valuable tool for developing mode-specific plans that reflect the priorities of the community.



Business owners and residents discuss downtown parking needs and solutions

Bike and Pedestrian Workshop Participants

Heather Andrews	Sherri Dow	Anne Nottingham
David Aschenbrenner, AC, WG	Parker Fitzpatrick, WG	Connie Ottoboni
Cheryl Ausmann-Moreno	Forris Frick, AC, WG	Susanna Pai
Lisa Batey	Mark Gamba	Matt Picio, WG
Jerry Bitz	Emily Gardner	Jon Stoll
John Climaldi	Willi Horner-Johnson, WG	Paul Sylvester
Noah Cowgill	Steven Kung	Aaron Tarfman
Debbie Cronk	Matt Menely, WG	Dottie Teeple
David DeVore	Renee Moog	Ann Wilson
Nick Dougher	Keith Neubauer	

Downtown Parking Working Group Participants

Melissa Arne	Lanice Coleman	Ed Parecki
David Aschenbrenner, AC, WG	Parker Fitzpatrick, WG	Ray Peck
Jean Baker	Neil Hankerson, AC	Zach Rogers
Jim Bernard	Greg Hemer	Joe Sandfort
Ray Bryan, WG	Lee Holzman	Nancy Wittig
Jill Chapman	Jason Jenkins	Ed Zumwalt, AC, WG
Tim Clouse	Tom Kemper	
Charmane Coleman	Jeff Klein	

Freight Working Group Participants

George Anderson	Brian Heiberg	Pat Russel, WG
Lorenzo Araque	Gary Hunt, AC	Dick Samuels
Charles Bishop	Bill Lake, AC	Todd Schwartz
Libby Clark-Agosti	Bernadine Moore	Charlie Stephens, AC
Steve Flury	Cara Nalam	

Street Design Working Group Participants

David Aschenbrenner, AC, WG	Alicia Hamilton	Matt Picio, WG
Ray Bryan, WG	Ben Horner-Johnson, AC, WG	Cami Waner
Kathy Buss, WG	Willi Horner-Johnson, WG	
Bruce Conachan	Virginia Pai, WG	

Traffic and Street Network Working Group Participants

David Aschenbrenner, AC	Ben Horner-Johnson, AC, WG	Leslie Schockner
Ray Bryan, WG	Tom MacFarlane	Julie Wisner, AC
Kathy Buss, WG	Matt Menely, WG	Ed Zumwalt, AC
Gail Curtis, AC	Matt Picio, WG	
Forris Frick, AC, WG	Pat Russel, WG	

Transit Working Group Participants

David Aschenbrenner, AC, WG	Lynda Hunter	Young Park
Ray Bryan, WG	Chistopher Hunterman	Phil Selinger
Sandi Burns	Dolly Macken-Hambright, AC	Pam Shea
Kathy Buss, WG	Sarah Maier	Dion Shepard, AC
Phil Favorite	Gary Michael	Ron Swanson
Forris Frick, AC, WG	Tim Morris	Marge Tipton
Ben Horner-Johnson, AC, WG	Virginia Pai, WG	Ed Zumwalt, AC, WG

Web Survey

The City posted a twelve-question self-selected survey on its website between March 1, 2007 and March 25, 2007 to both inform the community about the TSP process and to learn more about the issues and concerns of the community. One hundred and fifty eight people completed the survey including over 80% of respondents completing several open ended, narrative questions. In addition to learning about basic demographics, the questions were designed to gather information regarding how they use the transportation system and how they think it could be improved.

Paper surveys were made available; however all responses came via the internet. To make the survey more widely available to those without internet access, the survey was advertised at the Ledding Library's computer stations. Outreach in advertisement of the survey included:

- Advertised in the front page of the March Pilot
- Story and link on home page of City website
- Posters put in all bus stops at the Milwaukie Transit Center
- Emails sent to all TSP interested person's list
- Emails sent to all NDA members
- Emailed to Waldorf School
- Sent to all Milwaukie area North Clackamas Schools, including distribution to over 1300 recipients via the Milwaukie High School "E-News."
- Hand-delivered to Downtown Milwaukie businesses
- Article on BikePortland.org
- The TSP survey flyer was provided (in print copy or electronically, depending on preference) to: Dark Horse Comics, Albertsons (at Milwaukie Marketplace, handouts distributed with paychecks to all 87 associates), Pendleton Woolen Mills, Reliable Credit, Hoya, OECO, Bob's Red Mill, Johnson Controls.

Open Houses

An Open House was held July 12, 2007 to present all the recommendations of the Working Groups and Workshops to the broader community. Participants at the Open House were encouraged to offer their input on the recommendations and discuss their questions with staff. The material presented at the open house was also made available at the Farmer's Market on July 15, 2007, and posted on the TSP website.

Participant Exit Survey Results

All advisory committee and working group members were given exit surveys at the conclusion of their work. Respondents were asked to rate their group based on the following statements:

- The meeting facilitators encouraged and allowed all participants to share their ideas.
- My input was used to shape recommendations.
- I was given enough information to be prepared for each meeting.
- The information presented in meetings was clear and understandable.
- I now have a better understanding of transportation issues in Milwaukie.
- Meetings were efficient and made good use of my time.
- This Working Group/Workshop was worthwhile and out of it came good recommendations.
- I am glad I participated in this Working Group/Workshop.
- The overall TSP process was worthwhile and out of it came good recommendations.

Thirty-six participants completed exit surveys. Ninety-seven percent (35 of the 36 respondents) rated the TSP process high or very high for all aspects. Respondents were also provided space to leave general comments. A sampling of comments follows:

"I appreciated everyone's willingness to expand the meeting schedule to meet the needs of the bike community--including a bike boulevard assessment ride."

"The Milwaukie personnel were great to work with and from the sounds of things, they listened to the great ideas of the citizens. I look forward to the final outcome of our efforts through the remainder of planning."

"You (Alex), Katie and the team all did a great job. Thank you for including me, thoughtfully considering my comments, and working towards the initiatives of the North Industrial representatives. I hope to work with you again."

"Great job of public outreach. I've never seen that much outreach for a TSP before."

Information

The City used the public outreach communication methods listed below to announce special events and inform citizens about ongoing activities.

- The Pilot newsletter was mailed to every household in the city monthly.
- Flyers were posted at City facilities and the Milwaukie Farmers Market
- Community Services sent weekly email updates to over 100 people including all neighborhood association members and City board members.
- The City's Transportation Liaison sent updates to his contacts-including Parent-Teacher Organizations, churches, businesses, and individuals. This list currently includes over 100 contacts.
- Information was given through the video "bulletin boards" on the government and public access channels (23 and 30).
- A section dedicated to the TSP process was featured on the City's homepage. This section contained ongoing updates, meeting information, documents, and survey results.
- Staff visited all 7 Neighborhood District Associations to inform them about the project, both before it began and throughout the process.
- Flyers were sent to principals of all public and private Milwaukie schools.
- Updates were sent to the North Clackamas Chamber of Commerce to include in their newsletter.

The public came to rely on the City's website for the most up-to-date information about the project. All meeting materials, meeting announcements, survey results, and draft chapters were available for public review on the website.

Appendix C

Prioritized Master Plan Project List

Archival Note: Appendix C was created as part of the 2007 TSP update—it does not reflect the update process that was conducted in 2013.

The Prioritized Master Plan Project List contains all projects identified in the TSP update process. Projects came from many sources including, but not limited to, the following: 2007 TSP Working Groups, Milwaukie's Downtown Plan, Milwaukie's Capital Improvement Plan, 1997 TSP, and Metro's Regional Transportation Plan. All projects were vetted by staff, Working Group members, and Advisory Committee members.

The following process was used to prioritize the TSP projects.

- Working Group participants ranked projects as high, medium, or low.
- Staff evaluated each project against the TSP Goals using the Project Evaluation Questions. The idea behind the project evaluation questions is that, given the limited funds available, the City should prioritize funding of transportation projects that 1) effectively address identified problems, and 2) best meet the City's transportation goals. Projects that were ranked as low priority by the working groups were not evaluated unless other public involvement efforts (e.g. TSP Community Briefings or Open Houses), citizen groups (e.g. Neighborhood District Associations), or programs (e.g. Safe Trips to Schools Program or Capital Improvement Program) identified them as a priority.
- Staff also took other information into consideration before grouping the projects into high, medium, and low categories such as dependence on other projects or neighborhood support.
- Advisory Committee members reviewed staff's proposed project ranking and recommended some minor changes to the ranking of individual projects.

In addition to identifying the projects that are most important to the City, the Advisory Committee advised staff on which funding strategy to pursue in the development of the City's Action Plan. The Action Plan is the City's financially constrained project list that contains only those high priority projects that are likely to be funded with limited City funds within the 22-year planning period. The projects on the City's Action Plan are divided up by mode and appear in Chapters 5, 6, 7, 8, 9, 11, and 12 respectively. Action Plan projects are identified on the Prioritized Master Plan Project List by a "Yes" response in the column entitled "Is Project Funded?"

The Advisory Committee considered the following funding strategies.

- **Emphasis on direct City funding of projects.** This approach would encourage the City to fund projects itself and not use local funds to leverage outside funding. Taking this approach would require the City to save up for years to construct one or two projects (like widening Railroad Avenue) to the exclusion of many other projects.
- **Emphasis on leveraging City funds.** This approach would encourage the City to fund less expensive projects with local funds and to leverage state or federal funds with local match dollars for more expensive high priority projects. Taking this approach would theoretically enable the City to fund more projects than it could otherwise do on its own.

- **Emphasis on funding a range of high priority "implementable" projects.** This approach would encourage the City to strategically choose those projects that would provide the most benefit for the least cost and that had a realistic funding source. Taking this approach would enable the City to better respond to market conditions, grant opportunities, geographic equity issues, and economies of scale. It would also enable the City to fund a wide range of projects in the high priority category but not necessarily the highest priority projects.
- **Emphasis on funding high priority projects.** This approach would encourage the City to fund the highest priority projects, which would ensure that the highest priority projects were funded and not passed over due to high construction costs.
- **Emphasis on maintaining the existing system.** This approach would encourage the City to focus on maintenance and operations activities and not on capital improvements. Taking this approach would mean that very few identified high priority projects would be funded.

Staff recommended a combined strategy of emphasizing the funding of a range of high priority "implementable" projects and leveraging City funds as much as possible, and the Advisory Committee concurred with staff's recommendation. The projects identified as being funded on the Prioritized Master Plan Project List reflect this funding strategy.

TSP Project Evaluation Questions
"Which projects best meet Milwaukie's goals?"

Goals		Project	Score (0,1,2,3)
Goal 1	Livability. Design and construct transportation facilities in a manner that enhances the livability of Milwaukie's community.	Will the investment improve the health and physical well being of Milwaukie citizens? Will the investment protect residential neighborhoods from transportation-related impacts? Will the investment reduce barriers to mobility?	
Goal 2	Safety. Develop and maintain a safe and secure transportation system.	Will the investment improve an unsafe location or situation?	
Goal 3	Travel Choices. Plan, develop, and maintain a transportation system that provides travel choices and allows people to reduce the number of trips made by single-occupant vehicles.	Will the investment make it easier to move around without a car?	
Goal 4	Quality Design. Establish and maintain a set of transportation design and development regulations that are sensitive to local conditions.	Will the investment reinforce the character of a neighborhood? Will it reinforce the functional qualities of a street's classification?	
Goal 5	Reliability and Mobility. Develop and maintain a well-connected transportation system that reduces travel distance, improves reliability, and manages congestion.	Will the investment facilitate a better flow of traffic through or within Milwaukie?	
Goal 6	Sustainability. Provide a sustainable transportation system that meets the needs of present and future generations.	Will the investment improve the health of natural systems? Does the investment use resources wisely?	
Goal 7	Efficient and Innovative Funding. Efficiently allocate available funding for recommended transportation improvements, and pursue additional transportation funding that includes innovative funding methods and sources.	Will the investment use scarce City funds wisely?	
Goal 8	Compatibility. Develop a transportation system that is consistent with the City's Comprehensive Plan and that coordinates with County, State, and regional plans.	Will the investment support the city's vision while respecting those of other jurisdictions?	
Goal 9	Economic Vitality. Promote the development of Milwaukie's, the region's, and the state's economies through the efficient movement of people, goods, and services, and the distribution of information.	Will the investment support commercial interests in the city?	

Project Name	Project Description	From	To	Estimated Cost (\$1,000s) ¹	Priority Ranking ²	Is Project Funded? ³	Project Type	TSP Chapter	Citizen Working Group Ranking	Other Input	How well does project meet TSP Goals? (3 = very well, 0= not at all)																			
											Livability	Safety	Travel Choices	Quality Design	Reliability/Mobility	Sustainability	Efficient Funding	Compatibility	Economic Vitality	TOTAL SCORE										
HIGH PRIORITY PROJECTS																														
17 th Avenue Sidewalks	Fill in sidewalk gaps on both sides of street and improve intersections.	Ochoco St	McLoughlin Blvd	\$920	High	Yes	Capital	Pedestrian	High		2	3	3	2	0	1	2	3	1	17										
Downtown Transit Center Improvements	Construct new bus layover facility outside of the downtown core. Improve downtown bus stops and shelters consistent with level 3 features and including ample bike parking.	Location specific	Location specific	\$1,250	High	Yes	Capital	Transit	High	Council, NDAs	3	2	2	3	0	0	1	2	3	16										
17 th Avenue Bikeway and Intersection Safety Improvements	Fill in gaps in existing bicycle network with bike lanes or multi-use path. Improve intersection safety and eastbound connection at 17th Ave/Hwy 99E. Improve intersection safety at 17th Ave/Hwy 224.	Waverly Dr	Harrison St	\$135	High	Yes	Capital	Bicycle	High		1	3	3	2	0	1	3	2	1	16										
Logus Road Sidewalks	Fill in sidewalk gaps on both sides of street.	43rd Ave	49th Ave	\$771	High	Yes	Capital	Pedestrian	Low	Lewelling NDA, TSP Comments, STSP	2	3	3	2	0	2	2	2	0	16										
Kellogg Creek Dam Removal and Hwy 99E Underpass	Replace 99E bridge over Kellogg Creek, remove dam, restore habitat; construct pedestrian undercrossing between downtown Milwaukie and Riverfront Park.	Site Specific	Site Specific	\$9,000	High	Yes	Capital	Pedestrian	N/A	Downtown Plan	3	1	1	2	0	3	1	3	2	16										
Springwater Trail Completion	Contribute to regional project to complete Springwater Trail ("Sellwood Gap") along Ochoco Street.	17th Ave	19th Ave	\$80	High	Yes	Capital	Bicycle & Pedestrian	N/A	TSP Comments	3	3	3	0	0	1	3	3	0	16										
Railroad Avenue Sidewalks	Fill in sidewalk gaps on both sides of street.	37th Ave	Harmony Rd	\$1,625	High	Yes	Capital	Pedestrian & Transit	High		3	3	3	2	0	1	1	2	0	15										
Monroe Bicycle Boulevard	Designate as a Bicycle Boulevard and install bicycle boulevard improvements.	21st Ave	Linwood Ave	\$300	High	Yes	Capital	Bicycle	High		3	2	3	1	0	2	2	2	0	15										
29th/Harvey/40th Bicycle Boulevard	Designate as a Bicycle Boulevard and install bicycle boulevard improvements.	Springwater Trail	Monroe St	\$200	High	Yes	Capital	Bicycle	High		3	2	3	1	0	2	2	2	0	15										
Bike Lane Maintenance	Sweep bike lanes to remove debris.	Citywide	Citywide	\$1,100	High	Yes	Operational	Bicycle	High		2	3	2	1	0	2	3	2	0	15										
Monroe Street Sidewalks	Fill in sidewalk gaps on both sides of street.	42nd Ave	City Limits	\$1,631	High	Yes	Capital	Pedestrian	High		2	3	3	2	0	1	1	2	0	14										
Railroad Avenue Capacity Improvements	Widen SE Railroad Avenue to standard three lane cross section. Accommodate future bus service.	37 th Ave	Linwood Ave	\$12,990	High	Yes	Capital	Automobile & Transit	High		1	2	0	2	3	1	1	3	1	14										
Downtown Streetscape Improvements	Install sidewalk bulbouts, lighting, and pedestrian amenities.	Downtown	Downtown	\$6,700	High	Yes	Capital	Parking & Pedestrian	N/A	Downtown Plan	3	1	1	3	0	1	0	3	2	14										

Project Name	Project Description	From	To	Estimated Cost (\$1,000s) ¹	Priority Ranking ²	Is Project Funded? ³	Project Type	TSP Chapter	Citizen Working Group Ranking	Other Input	How well does project meet TSP Goals? (3 = very well, 0= not at all)									
											Livability	Safety	Travel Choices	Quality Design	Reliability/Mobility	Sustainability	Efficient Funding	Compatibility	Economic Vitality	TOTAL SCORE
Bike Route Signage	Install neighborhood bike route signage.	Citywide	Citywide	\$150	High	Yes	Operational	Bicycle	High		1	2	2	0	0	1	3	3	1	13
Hwy 224 Intersection Improvements at Oak	Add left turn-lanes and protected signal phasing on Oak Street approaches.	Location specific	Location specific	\$20	High	Yes	Capital	Automobile	Low	TSP Comments, NDAs	3	1	0	0	2	1	2	1	3	13
King Road Boulevard Treatments	Install street boulevard treatments: widen sidewalks and improve multiple crossings.	42nd Ave	Linwood	\$500	High	Yes	Capital	Pedestrian	N/A		2	2	1	2	0	1	2	2	1	13
Neighborhood Pedestrian and Traffic Safety Program	Complete a few small traffic calming and pedestrian safety projects throughout the city each year.	Citywide	Citywide	\$300	High	Yes	Capital	Nbrhd Traffic Management	N/A	NTMP, NDAs	3	2	1	2	0	1	2	2	0	13
Hwy 224 & Hwy 99E Refinement Plan	Conduct refinement study that focuses on minimizing barrier effect and improving auto and freight mobility.	Hwy 99E Project Limits: Tacoma St to 17th Ave	Hwy 224 Project Limits: Hwy 99E to Lake Rd Interchange	\$250	High	Yes	Capital	Automobile & Freight	High		0	0	0	3	1	0	3	3	1	11
Railroad Crossing Safety and Quiet Zone Project	Construct railroad crossing safety improvements at Oak Street, Harrison Street, and 37th Avenue.	Location specific	Location specific	\$285	High	Yes	Capital	Automobile & Pedestrian	Med	NDAs, TSP Comments, Quiet Zone	3	3	0	0	0	0	3	2	0	11
Stanley Avenue Sidewalks	Fill in sidewalk gaps on both sides of street.	Johnson Creek Blvd	Railroad Ave	\$4,304	High	No	Capital	Pedestrian	High		2	3	3	2	0	1	1	2	0	14
Harrison Street Railroad Crossing Separation	Upgrade Harrison crossing of Union Pacific Railroad tracks to grade-separated facility. Assess as part of Hwy 224 & Hwy 99E Refinement Plan.	Location specific	Location specific	\$28,000	High	No	Capital	Freight	High		3	2	0	1	3	1	0	2	2	14
Hwy 224 Intersection Improvements at 37 th	Consolidate the two northern legs of 37th Avenue and International Way into one leg at Hwy 224.	Location specific	Location specific	\$1,946	High	No	Capital	Automobile & Freight	High		1	2	0	1	3	0	1	1	3	12
Railroad Avenue Bike Lanes	Fill in gaps in existing bicycle network with bike lanes.	37 th Ave	Linwood Ave	\$4,364	High	No	Capital	Bicycle	Low		2	2	2	2	1	1	1	1	0	12
Linwood Avenue Capacity Improvements (north)	Widen to standard three lane cross section. Widen bridge over Johnson Creek.	Johnson Creek Blvd	King Rd	\$8,500	High	No	Capital	Automobile	High		0	1	1	2	3	0	0	3	1	11
Linwood Avenue Capacity Improvements (south)	Widen to standard three lane cross section.	King Rd	Harmony Rd	\$11,400	High	No	Capital	Automobile	High		1	1	0	2	3	0	0	3	1	11
Hwy 224 Crossing Improvements at Oak and Washington	Improve intersection crossing safety for cyclists at Washington Street and Oak Street.	Location specific	Location specific	\$10	High	No	Capital	Bicycle	Med		1	1	2	0	0	1	3	1	0	9
Downtown Parking Enforcement	Implement parking management system, including a dedicated parking manager.	Downtown	Downtown	\$40	High	No	Operational	Parking	High		1	0	0	0	0	0	3	1	3	8

Project Name	Project Description	From	To	Estimated Cost (\$1,000s) ¹	Priority Ranking ²	Is Project Funded? ³	Project Type	TSP Chapter	Citizen Working Group Ranking	Other Input	How well does project meet TSP Goals? (3 = very well, 0= not at all)									
											Livability	Safety	Travel Choices	Quality Design	Reliability/Mobility	Sustainability	Efficient Funding	Compatibility	Economic Vitality	TOTAL SCORE
MEDIUM PRIORITY PROJECTS																				
Lake Road Sidewalks	Fill in sidewalk gaps on both sides of street.	Kuehn Rd	Hwy 224	\$2,049	Medium	No	Capital	Pedestrian	High		2	3	3	2	0	1	1	1	1	14
Stanley Avenue Bicycle Boulevard	Designate as a Bicycle Boulevard and install bicycle boulevard improvements.	Springwater Trail	Railroad Ave	\$300	Medium	No	Capital	Bicycle	High		3	2	3	1	0	1	1	2	0	13
19 th and Sparrow Bicycle Boulevard	Designate as a Bicycle Boulevard and install bicycle boulevard improvements. This would connect the south end of Kellogg Creek Trail to River Rd.	Eagle St	River Rd	\$737	Medium	No	Capital	Bicycle	Med		2	2	3	1	0	1	2	2	0	13
Franklin Street Sidewalks	Install sidewalks on both sides of street to connect to Hector Campbell Elementary School.	42nd Ave	45th Ave	\$200	Medium	No	Capital	Pedestrian	N/A	STSP, CIP (04-05)	2	3	3	1	0	1	1	2	0	13
Intersection Improvements at Main and Mailwell	Upgrade intersection turning radii to better accommodate freight movements.	Location specific	Location specific	\$50	Medium	No	Capital	Freight	High		0	1	0	3	2	0	1	2	3	12
McLoughlin Boulevard Sidewalks	Fill in sidewalk gaps on both sides of street.	Washington St	Southern City Limits	\$596	Medium	No	Capital	Pedestrian	Med		1	3	2	1	0	1	1	2	1	12
Downtown Parking Signage	Install wayfinding and identification signage at McLoughlin Blvd. intersections and around public parking lots.	Downtown	Downtown	\$10	Medium	No	Capital	Parking	High		1	0	0	2	0	0	3	2	3	11
Railroad Crossing Improvements at Harrison	Upgrade paving materials to concrete or rubberized material to improve longevity and enhance for alternative modes.	Location specific	Location specific	\$50	Medium	No	Capital	Freight	Low		1	2	2	2	0	0	2	1	1	11
Railroad Crossing Improvements at 21st and Adams	Upgrade paving materials to concrete or rubberized material to improve longevity and enhance for alternative modes.	Location specific	Location specific	\$50	Medium	No	Capital	Freight	Low		1	2	2	2	0	0	2	1	1	11
Railroad Crossing Improvements at Monroe	Upgrade paving materials to concrete or rubberized material to improve longevity and enhance for alternative modes.	Location specific	Location specific	\$50	Medium	No	Capital	Freight	Low		1	2	2	2	0	0	2	1	1	11
Railroad Crossing Improvements at Washington	Upgrade paving materials to concrete or rubberized material to improve longevity and enhance for alternative modes.	Location specific	Location specific	\$50	Medium	No	Capital	Freight	Low		1	2	2	2	0	0	2	1	1	11
Railroad Crossing Improvements at Oak	Upgrade paving materials to concrete or rubberized material to improve longevity and enhance for alternative modes.	Location specific	Location specific	\$50	Medium	No	Capital	Freight	Low		1	2	2	2	0	0	2	1	1	11

Project Name	Project Description	From	To	Estimated Cost (\$1,000s) ¹	Priority Ranking ²	Is Project Funded? ³	Project Type	TSP Chapter	Citizen Working Group Ranking	Other Input	How well does project meet TSP Goals? (3 = very well, 0= not at all)									
											Livability	Safety	Travel Choices	Quality Design	Reliability/Mobility	Sustainability	Efficient Funding	Compatibility	Economic Vitality	TOTAL SCORE
Railroad Crossing Improvements at 37 th	Upgrade paving materials to concrete or rubberized material to improve longevity and enhance for alternative modes.	Location specific	Location specific	\$50	Medium	No	Capital	Freight	Low		1	2	2	2	0	0	2	1	1	11
Pedestrian Walkway Amenities	Install amenities, such as benches, along key walking routes.	Citywide	Citywide	\$50	Medium	No	Capital	Pedestrian	Med		2	0	1	3	0	1	2	1	1	11
Main Street Bike Lanes	Fill in gaps in existing bicycle network with bike lanes.	Harrison St	Moore St	\$2,131	Medium	No	Capital	Bicycle	Med		1	1	2	1	0	1	2	1	2	11
McLoughlin Blvd Intersection Improvements at 17 th	Prohibit left turn movement from 17 th Avenue to northbound McLoughlin Blvd and include in Hwy 224 & Hwy 99E Refinement Plan.	Location specific	Location specific	\$15	Medium	No	Capital	Automobile	Med		1	1	0	0	3	0	3	2	1	11
Intersection Improvements at 42 nd and Harrison	Signalize intersection to facilitate dominant traffic flow.	Location specific	Location specific	\$252	Medium	No	Capital	Automobile	Med		1	1	1	0	3	1	2	1	1	11
McLoughlin Boulevard Intersection Improvements at River Road	Consolidate a single access point for the area at Bluebird Street with full intersection treatment and signalization or add second northbound left-turn lane at River Road.	Location specific	Location specific	\$898	Medium	No	Capital	Automobile	Med		1	2	1	1	3	0	1	1	0	10
Harrison and King Connection	Enhance connection between King Road and Harrison Street at 42 nd Avenue.	Location specific	Location specific	\$53	Medium	No	Capital	Automobile	Med		0	2	0	0	3	0	2	1	2	10
37 th Avenue Sidewalks	Fill in sidewalk gaps on both sides of street.	Lake Rd	Harrison St	\$794	Medium	No	Capital	Pedestrian	Low		2	2	2	2	0	0	1	1	0	10
Intersection Improvements at 42 nd and King	Enhance intersection function.	Location specific	Location specific	\$15	Medium	No	Capital	Pedestrian	Med		0	1	1	0	3	0	2	1	2	10
Pedestrian Walkway Signage	Provide maps and wayfinding signage on streets that identify ways to get around the city.	Citywide	Citywide	\$10	Medium	No	Operational	Pedestrian	Med		1	0	2	0	0	2	2	2	0	9
Downtown Public Parking Lot Improvements	Upgrade and maintain off-street public parking facilities with improved landscaping and lighting.	Downtown	Downtown	\$50	Medium	No	Capital	Parking	Med		2	2	0	1	0	0	1	0	3	9
Community Bicycle Rides	Coordinate community bike rides to encourage bike use.	Citywide	Citywide	\$5	Medium	No	Operational	Bicycle	Med		3	2	2	0	0	1	1	0	0	9
Intersection Improvements at Harrison and Hwy 224	Add left turn-lanes and protected signal phasing on Harrison Street approaches.	Location specific	Location specific	\$20	Medium	No	Capital	Automobile	Med		1	1	2	0	0	1	3	1	0	9
Cyclist Education	Promote cycling through bike use and route selection education.	Citywide	Citywide	\$10	Medium	No	Operational	Bicycle	High		1	3	2	0	0	0	1	1	0	8
Railroad Crossing Pedestrian Improvements at Oak	Improve intersection for pedestrians.	Location specific	Location specific	\$15	Medium	No	Capital	Pedestrian	Med		1	3	2	0	0	0	1	1	0	8
Harrison Street Bike Lanes	Fill in gaps in existing bicycle network with bike lanes.	Hwy 99E	21st Ave	\$273	Medium	No	Capital	Bicycle	Med		1	2	2	1	0	0	1	1	0	8

Project Name	Project Description	From	To	Estimated Cost (\$1,000s) ¹	Priority Ranking ²	Is Project Funded? ³	Project Type	TSP Chapter	Citizen Working Group Ranking	Other Input	How well does project meet TSP Goals? (3 = very well, 0= not at all)									
											Livability	Safety	Travel Choices	Quality Design	Reliability/Mobility	Sustainability	Efficient Funding	Compatibility	Economic Vitality	TOTAL SCORE
Intersection Improvements at Linwood and King	Implement protected/permissive left turn phasing for northbound and southbound approaches.	Location specific	Location specific	\$16	Medium	No	Capital	Automobile	Med		0	2	0	0	3	1	1	1	0	8
Brookside Drive Sidewalks	Fill in sidewalk gaps on both sides of street.	Johnson Creek Blvd	Regents Dr	\$15	Medium	No	Capital	Pedestrian	Med		2	1	1	2	0	0	1	1	0	8
Springwater Trail Paving Project	Improve corridor through repaving existing trail.	29th Ave	Linwood Ave	\$500	Medium	No	Capital	Bicycle	Med		2	0	2	1	0	0	1	1	0	7
Lake Road Capacity Improvements	Widen to standard three lane cross section.	21st Ave	Oatfield Rd	\$7,392	Medium	No	Capital	Automobile	Med	NDA's, TSP Comments	0	2	0	2	1	0	0	1	1	7
Harrison Street Capacity Improvements	Widen to standard three lane cross section.	32nd St	42nd St	\$2,565	Medium	No	Capital	Automobile	Med		0	1	0	1	3	0	0	1	1	7
Johnson Creek Blvd Intersection Improvements at Linwood	Add eastbound right turn lane and westbound right turn lane.	Location specific	Location specific	\$803	Medium	No	Capital	Automobile	Med		0	1	0	0	3	1	1	1	0	7
Harrison Street Intersection Improvements at Main	Add westbound shared through/right turn lane or eastbound right turn lane.	Location specific	Location specific	\$34	Medium	No	Capital	Automobile	Med		0	0	0	0	2	0	1	2	1	6
Public Parking Structure	Construct 3 to 4 story public parking structure with retail at ground floor for visitor/employee parking.	Location specific	Location specific	\$10,000	Medium	No	Capital	Parking	Low		1	0	0	0	0	1	0	1	3	6
LOW PRIORITY PROJECTS																				
Ochoco Street Sidewalks	Construct sidewalks on Ochoco Street to connect bus stops to Goodwill.	19th Ave	McLoughlin Blvd	\$\$\$	Low	No	Capital	Pedestrian	NA		1	3	2	1	0	0	0	2	1	10
Kronberg Park Trail	Construct multi-modal trail along Kellogg Creek connecting Kronberg Park to downtown Milwaukie.	McLoughlin Blvd	Downtown	\$1,200	Low	No	Capital	Bicycle	NA	Regional Trail Plan	2	2	1	1	0	0	1	2	1	10
Springwater Corridor Intersection Improvements at 45th	Improve safety of crossing at intersection.	Location specific	Location specific	\$10	Low	No	Capital	Bicycle	Med		2	1	1	1	0	1	0	1	0	7
Johnson Creek Blvd and 42nd Avenue Signalization	Replace 3-way stop with signal when warranted.	Location specific	Location specific	\$250	Low	No	Capital	Automobile	NA		0	1	0	0	1	1	1	1	0	5
Springwater Trail Ramp Improvement	Improve ramp at Springwater Trail and McLoughlin Blvd.	Location specific	Location specific	\$15	Low	Yes	Capital	Bicycle & Pedestrian	N/A	TSP Comments	Project not evaluated.									0
19th Avenue Sidewalks	Fill in sidewalk gaps on both sides of street.	Kellogg Creek Trail	Sparrow St	\$305	Low	No	Capital	Pedestrian	Low		Project not evaluated.									0
22nd Avenue Sidewalks	Fill in sidewalk gaps on both sides of street.	McLoughlin Blvd	Sparrow St	\$325	Low	No	Capital	Pedestrian	Low		Project not evaluated.									0
43rd Avenue Sidewalks	Fill in sidewalk gaps on both sides of street.	Howe St/42nd Ave	King Rd/43rd Ave	\$550	Low	No	Capital	Pedestrian	Low		Project not evaluated.									0
Edison Street Sidewalks	Fill in sidewalk gaps on both sides of street.	35th Ave	37th Ave	\$116	Low	No	Capital	Pedestrian	Low		Project not evaluated.									0
Harmony Road Sidewalks	Fill in sidewalk gaps on both sides of street.	Linwood Ave	City Limits	\$38	Low	No	Capital	Pedestrian	Low		Project not evaluated.									0

Project Name	Project Description	From	To	Estimated Cost (\$1,000s) ¹	Priority Ranking ²	Is Project Funded? ³	Project Type	TSP Chapter	Citizen Working Group Ranking	Other Input	How well does project meet TSP Goals? (3 = very well, 0= not at all)									
											Livability	Safety	Travel Choices	Quality Design	Reliability/Mobility	Sustainability	Efficient Funding	Compatibility	Economic Vitality	TOTAL SCORE
Harvey Street Sidewalks	Fill in sidewalk gaps on both sides of street.	32nd Ave	42nd Ave	\$534	Low	No	Capital	Pedestrian	Low		Project not evaluated.									0
Home Avenue Sidewalks	Fill in sidewalk gaps on both sides of street.	Railroad Ave	King Rd	\$756	Low	No	Capital	Pedestrian	Low		Project not evaluated.									0
International Way Sidewalks	Fill in sidewalk gaps on both sides of street	Criterion Ct	Lake Rd	\$767	Low	No	Capital	Pedestrian	Low		Project not evaluated.									0
Johnson Creek Boulevard Sidewalks	Fill in sidewalk gaps on both sides of street.	Harney Dr	City Limits	\$378	Low	No	Capital	Pedestrian	Low		Project not evaluated.									0
Linwood Avenue Sidewalks	Fill in sidewalk gaps on both sides of street.	Johnson Creek Blvd	Railroad Ave	\$2,960	Low	No	Capital	Pedestrian	Low		Project not evaluated.									0
Mason Lane Sidewalks	Fill in sidewalk gaps on both sides of street.	42nd Ave	Regents Dr	\$671	Low	No	Capital	Pedestrian	Low		Project not evaluated.									0
Oatfield Road Sidewalks	Fill in sidewalk gaps on both sides of street.	Guilford Ct	City Limits	\$132	Low	No	Capital	Pedestrian	Low		Project not evaluated.									0
Regents Drive Sidewalks	Fill in sidewalk gaps on both sides of street.	Brookside Dr	Winsor Dr	\$494	Low	No	Capital	Pedestrian	Low		Project not evaluated.									0
River Road Sidewalks	Fill in sidewalk gaps on both sides of street.	McLoughlin Blvd	City Limits	\$626	Low	No	Capital	Pedestrian	Low		Project not evaluated.									0
Roswell Street Sidewalks	Fill in sidewalk gaps on both sides of street.	32nd Ave	36th Ave	\$192	Low	No	Capital	Pedestrian	Low		Project not evaluated.									0
Rusk Road Sidewalks	Fill in sidewalk gaps on both sides of street.	Lake Rd	North Clackamas Park	\$662	Low	No	Capital	Pedestrian	Low		Project not evaluated.									0
Olsen Street Sidewalks	Fill in sidewalk gaps on north side of street.	32nd Ave	42nd Ave	\$432	Low	No	Capital	Pedestrian	Low		Project not evaluated.									0
49th Avenue Sidewalks	Fill in sidewalk gaps on both sides of street.	Logus Rd	King Rd	\$250	Low	No	Capital	Pedestrian	Low		Project not evaluated.									0
Hwy 224 Sidewalks	Fill in sidewalk gaps on both sides of street.	Oak St	37th Ave	\$420	Low	No	Capital	Pedestrian	Low		Project not evaluated.									0
Intersection Curb Ramp Improvements	Install curb ramps at all intersections with sidewalks.	Citywide	Citywide	\$5	Low	No	Capital	Pedestrian	Low		Project not evaluated.									0
Hwy 224 Intersection Improvements at 37th	Improve pedestrian crossing.	Location specific	Location specific	\$20	Low	No	Capital	Pedestrian	Low		Project not evaluated.									0
Hwy 224 Intersection Improvements at Freeman	Improve pedestrian crossing.	Location specific	Location specific	\$20	Low	No	Capital	Pedestrian	Low		Project not evaluated.									0
Hwy 224 Intersection Improvements at Harrison	Improve pedestrian crossing.	Location specific	Location specific	\$20	Low	No	Capital	Pedestrian	Low		Project not evaluated.									0
Hwy 224 Intersection Improvements at Monroe	Improve pedestrian crossing.	Location specific	Location specific	\$15	Low	No	Capital	Pedestrian	Low		Project not evaluated.									0
Hwy 224 Intersection Improvements at Oak	Improve pedestrian crossing.	Location specific	Location specific	\$20	Low	No	Capital	Pedestrian	Low		Project not evaluated.									0
Intersection Improvements at Olsen and 42nd	Improve pedestrian crossing.	Location specific	Location specific	\$20	Low	No	Capital	Pedestrian	Low		Project not evaluated.									0
Intersection Improvements at Harmony and Lake	Improve pedestrian crossing.	Location specific	Location specific	\$15	Low	No	Capital	Pedestrian	Low		Project not evaluated.									0

Project Name	Project Description	From	To	Estimated Cost (\$1,000s) ¹	Priority Ranking ²	Is Project Funded? ³	Project Type	TSP Chapter	Citizen Working Group Ranking	Other Input	How well does project meet TSP Goals? (3 = very well, 0= not at all)									
											Livability	Safety	Travel Choices	Quality Design	Reliability/Mobility	Sustainability	Efficient Funding	Compatibility	Economic Vitality	TOTAL SCORE
Intersection Improvements at Railroad and 37 th	Improve pedestrian crossing.	Location specific	Location specific	\$10	Low	No	Capital	Pedestrian	Low		Project not evaluated.									0
Intersection Improvements at Stanley and Logus	Improve pedestrian crossing.	Location specific	Location specific	\$15	Low	No	Capital	Pedestrian	Low		Project not evaluated.									0
Springwater Trail Ramp Improvement at McLoughlin	Improve ramp at Springwater Trail and McLoughlin Blvd.	Location specific	Location specific	\$15	Low	No	Capital	Pedestrian	Low		Project not evaluated.									0
Pedestrian Connection to North Clackamas Park	Create pedestrian connection between the school and the park.	Rowe Middle School	North Clackamas Park	\$1,284	Low	No	Capital	Pedestrian	Low		Project not evaluated.									0
Hwy 224 Intersection Improvements at 17 th	Upgrade intersection turning radii to better accommodate freight movements.	Location specific	Location specific	\$50	Low	No	Capital	Freight	Low		Project not evaluated.									0
Intersection Improvements at Mailwell and Omark	Upgrade intersection turning radii to better accommodate freight movements.	Location specific	Location specific	\$50	Low	No	Capital	Freight	Low		Project not evaluated.									0
Bicycle and Pedestrian Overpass	Establish a dedicated bicycle and pedestrian connection across Railroad Avenue and the railroad tracks.	Railroad Ave	International Way	\$2,025	Low	No	Capital	Bicycle	Low		Project not evaluated.									0
Bicycle-friendly Street Grates	Install bicycle-friendly street grates.	Citywide	Citywide	\$50	Low	No	Operational	Bicycle	Low		Project not evaluated.									0
Milwaukie Bike Map	Produce a Milwaukie Bike Map.	Citywide	Citywide	\$50	Low	No	Operational	Bicycle	Low		Project not evaluated.									0
Trolley Trail Signage	Design and install Trolley Trail signage.	Milwaukie Riverfront	Southern City Limits	\$54	Low	No	Capital	Bicycle	Low		Project not evaluated.									0
Springwater Trail Signage	Install wayfinding signage for Springwater Trail.	Citywide	Citywide	\$15	Low	No	Operational	Bicycle	Low		Project not evaluated.									0
Intersection Improvements at Johnson Creek Blvd and Linwood	Improve safety of crossing at intersection.	Location specific	Location specific	\$10	Low	No	Capital	Bicycle	Low		Project not evaluated.									0
Intersection Improvements at Linwood and King	Improve safety of crossing at intersection.	Location specific	Location specific	\$10	Low	No	Capital	Bicycle	Low		Project not evaluated.									0
Intersection Improvements at Linwood and Harmony	Improve safety of crossing at intersection.	Location specific	Location specific	\$10	Low	No	Capital	Bicycle	Low		Project not evaluated.									0
Intersection Improvements at Linwood and Monroe	Improve safety of crossing at intersection.	Location specific	Location specific	\$10	Low	No	Capital	Bicycle	Low		Project not evaluated.									0
Intersection Improvements at International Way and Lake Road	Improve safety of crossing at intersection.	Location specific	Location specific	\$10	Low	No	Capital	Bicycle	Low		Project not evaluated.									0
Intersection Improvements at Adams and 21 st	Improve safety of crossing at intersection.	Location specific	Location specific	\$10	Low	No	Capital	Bicycle	Low		Project not evaluated.									0
Lake Road Bike Lanes	Fill in gaps in existing bicycle network with bike lanes.	Main St	Guilford Dr	\$3,142	Low	No	Capital	Bicycle	Low		Project not evaluated.									0
Harrison Street Bike Lanes	Fill in gaps in existing bicycle network with bike lanes.	Hwy 224	42 nd Ave	\$13	Low	No	Capital	Bicycle	Low		Project not evaluated.									0
37 th Avenue Bike Lanes	Fill in gaps in existing bicycle network with bike lanes.	Harrison St	Hwy 224	\$2,900	Low	No	Capital	Bicycle	Low		Project not evaluated.									0

Project Name	Project Description	From	To	Estimated Cost (\$1,000s) ¹	Priority Ranking ²	Is Project Funded? ³	Project Type	TSP Chapter	Citizen Working Group Ranking	Other Input	How well does project meet TSP Goals? (3 = very well, 0= not at all)										
											Livability	Safety	Travel Choices	Quality Design	Reliability/Mobility	Sustainability	Efficient Funding	Compatibility	Economic Vitality	TOTAL SCORE	
43 rd Avenue Bike Lanes	Fill in gaps in existing bicycle network with bike lanes.	King Rd	Filbert St	\$1,014	Low	No	Capital	Bicycle	Low		Project not evaluated.										0
Oatfield Road Bike Lanes	Fill in gaps in existing bicycle network with bike lanes.	Guilford Ct	Lake Rd	\$348	Low	No	Capital	Bicycle	Low		Project not evaluated.										0
Linwood Avenue Bike Lanes (north)	Fill in gaps in existing bicycle network with bike lanes.	Queen Rd	Johnson Creek Blvd	\$1,692	Low	No	Capital	Bicycle	Low		Project not evaluated.										0
Linwood Avenue Bike Lanes (south)	Fill in gaps in existing bicycle network with bike lanes.	Juniper St	Harmony Rd	\$296	Low	No	Capital	Bicycle	Low		Project not evaluated.										0
Rusk Road Bike Lanes	Fill in gaps in existing bicycle network with bike lanes.	Lake Rd	North Clackamas Park	\$936	Low	No	Capital	Bicycle	Low		Project not evaluated.										0
21 st Avenue Bike Lanes	Fill in gaps in existing bicycle network with bike lanes.	Harrison St	Lake Rd	\$50	Low	No	Capital	Bicycle	NA	Downtown Plan	Project not evaluated.										0
Police Enforcement on Drivers	Enforce laws related to bike lanes and bicycle safety.	Citywide	Citywide	\$10	Low	No	Operational	Bicycle	Low		Project not evaluated.										0
Bike Lane Striping	Re-stripe existing bike lanes and stripe bike lanes on streets where buses and bicyclists share the road.	Citywide	Citywide	\$20	Low	No	Operational	Bicycle & Transit	Low		Project not evaluated.										0
Kellogg Creek Trail Improvements	Resurface trail and provide wayfinding signage to/from trail.	Milwaukie Riverfront	Treatment Plant	\$623	Low	No	Capital	Bicycle	Low		Project not evaluated.										0
Hwy 224 Access Modifications at Freeman Way	Modify access at Freeman Way to improve intersection functioning.	Location specific	Location specific	\$1,313	Low	No	Capital	Automobile	Low		Project not evaluated.										0
Stanley Ave Connectivity at King	Enhance connection along Stanley Ave at King Road.	Location specific	Location specific	\$53	Low	No	Capital	Automobile	Low		Project not evaluated.										0
Stanley Ave Connectivity at Monroe	Enhance connection along Stanley Avenue at Monroe Street.	Location specific	Location specific	\$53	Low	No	Capital	Automobile	Low		Project not evaluated.										0
Harmony Road Grade Separation and Realignment at Linwood	Grade separate Harmony Road from Union Pacific Railroad and align as a through east-west movement. Outcome of alignment and geometry is dependant upon the Harmony Road Environmental Assessment project (scheduled for completion Fall 2008).	Location specific	Location specific	\$28,000	Low	No	Capital	Freight & Automobile	Low		Project not evaluated.										0
Regional Projects within or through the City of Milwaukie⁴																					
Milwaukie Light Rail Extension or High Capacity Transit Improvements	Construct light rail or high capacity transit improvements between Milwaukie and Portland.	Rose Quarter MAX Station	Milwaukie Town Center	\$515,000	—	No	Capital	Transit	—	2004 RTP	Project not evaluated.										0
Oregon City Light Rail Extension or High Capacity Transit Improvements	Construct light rail or high capacity transit improvements between Milwaukie and Oregon City.	Milwaukie Town Center	Oregon City	\$577,500	—	No	Capital	—	—	2004 RTP	Project not evaluated.										0
Milwaukie Transportation Management Association Program	Implement a transportation management association for employers.	Milwaukie Town Center	Milwaukie Town Center	\$200	—	No	Operational	Transit	—	2004 RTP	Project not evaluated.										0

Project Name	Project Description	From	To	Estimated Cost (\$1,000s) ¹	Priority Ranking ²	Is Project Funded? ³	Project Type	TSP Chapter	Citizen Working Group Ranking	Other Input	How well does project meet TSP Goals? (3 = very well, 0= not at all)									
											Livability	Safety	Travel Choices	Quality Design	Reliability/Mobility	Sustainability	Efficient Funding	Compatibility	Economic Vitality	TOTAL SCORE
Portland Traction Company Multi-Use Trail	Plan, engineer, and construct multi-use trail along Portland Traction Company right-of-way.	Milwaukie	Gladstone	\$1,386	—	No	Capital	—	—	2004 RTP	Project not evaluated.									0
North Clackamas Greenway Corridor Study	Study feasibility of corridor for multi-use path construction (possibly along Kellogg Creek).	Milwaukie	Clackamas Regional Center	—	—	No	Capital	—	—	2004 RTP	Project not evaluated.									0
Linwood/Harmony/Lake Road Intersection Improvements	Add northbound right turn lane and eastbound right turn lane.	Location specific	Location specific	\$28,000	—	No	Capital	—	—	2004 RTP	Project not evaluated.									0
McLoughlin Boulevard Improvements	Complete boulevard design improvements.	Scott St	Harrison St	\$3,300	—	No	Capital	—	—	2004 RTP	Project not evaluated.									0
Tillamook Branch Trestle Trail Study	Study feasibility of east-west multi-use trail construction.	Milwaukie Town Center	Lake Oswego Town Center	—	—	No	Capital	—	—	2004 RTP	Project not evaluated.									0
Railroad Junction Improvements	Implement track and signal improvements to allow for increased track speeds between UP Willsburg Junction and UP Albina Yards.	Milwaukie	UP Railroad Albina Yards	\$8,800	—	No	Capital	—	—	2004 RTP	Project not evaluated.									0
Railroad Track Extension	Extend two tracks from Willsburg Junction to Clackamas.	Milwaukie	I-205	\$19,000	—	No	Capital	—	—	2004 RTP	Project not evaluated.									0

¹ In the case of operational projects, estimated costs are for entire 22-year planning period.

² Projects are ranked as either high, medium, or low. They are in no particular order within their ranking.

³ Funded projects are listed on one of the mode-specific Action Plans in the TSP and are expected to be funded within the 22-year planning period through either direct or leveraged City funding.

⁴ 2004 Regional Transportation Plan (RTP) projects in the Milwaukie area that may or may not be shown on mode-specific master plans or project lists.

Key:

NDA = Neighborhood District Association

NTMP = Neighborhood Traffic Management Program

CIP = Capital Improvement Program

STSP = Safe Trips to School Program

RTP = Regional Transportation Plan

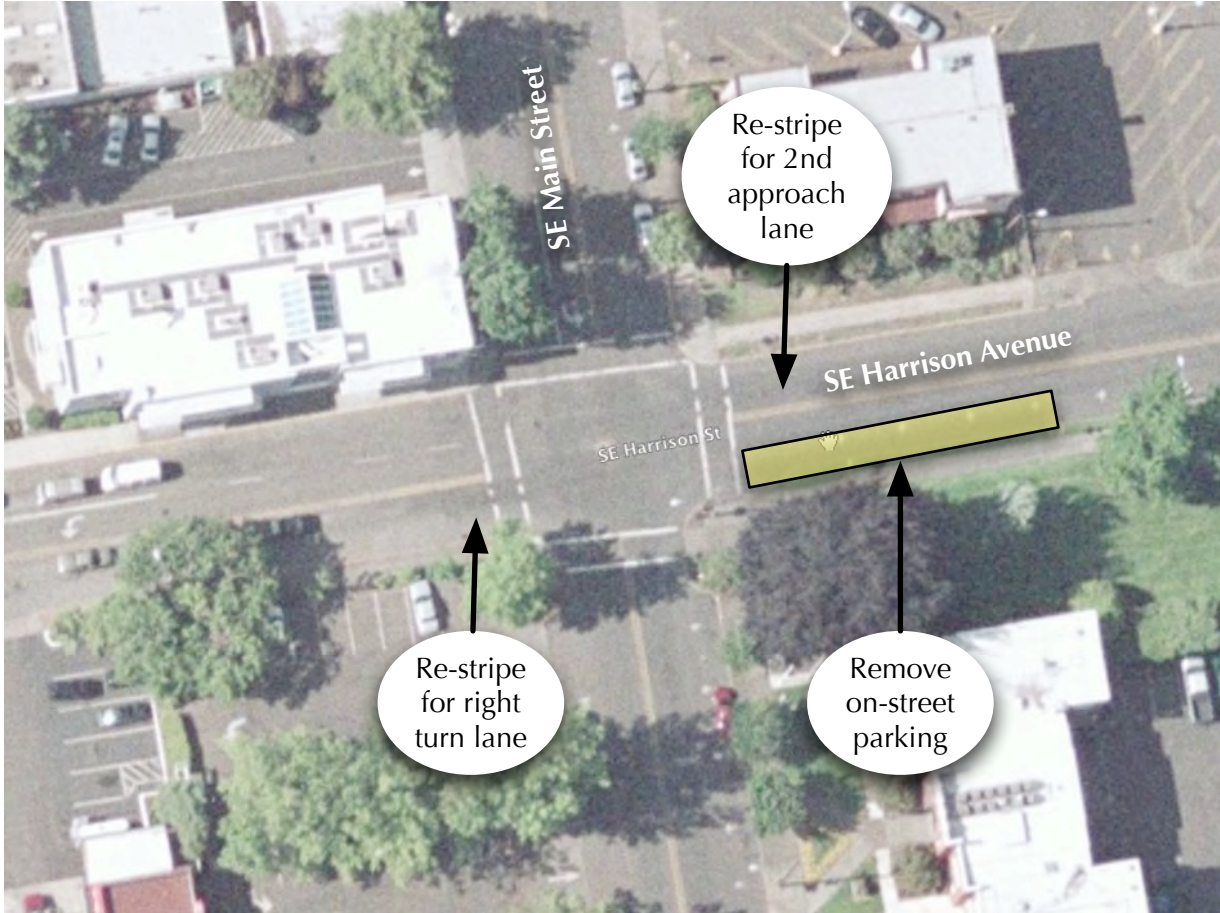
Appendix D

Conceptual Design Options

Archival Note: *Appendix D was created as part of the 2007 TSP update—it does not reflect the update process that was conducted in 2013.*

The Street Auto Network Working Group discussed the following design options during the TSP update process. These design options were developed to address current and/or future operational deficiencies at TSP study intersections.

1. SE Harrison Avenue / SE Main Street



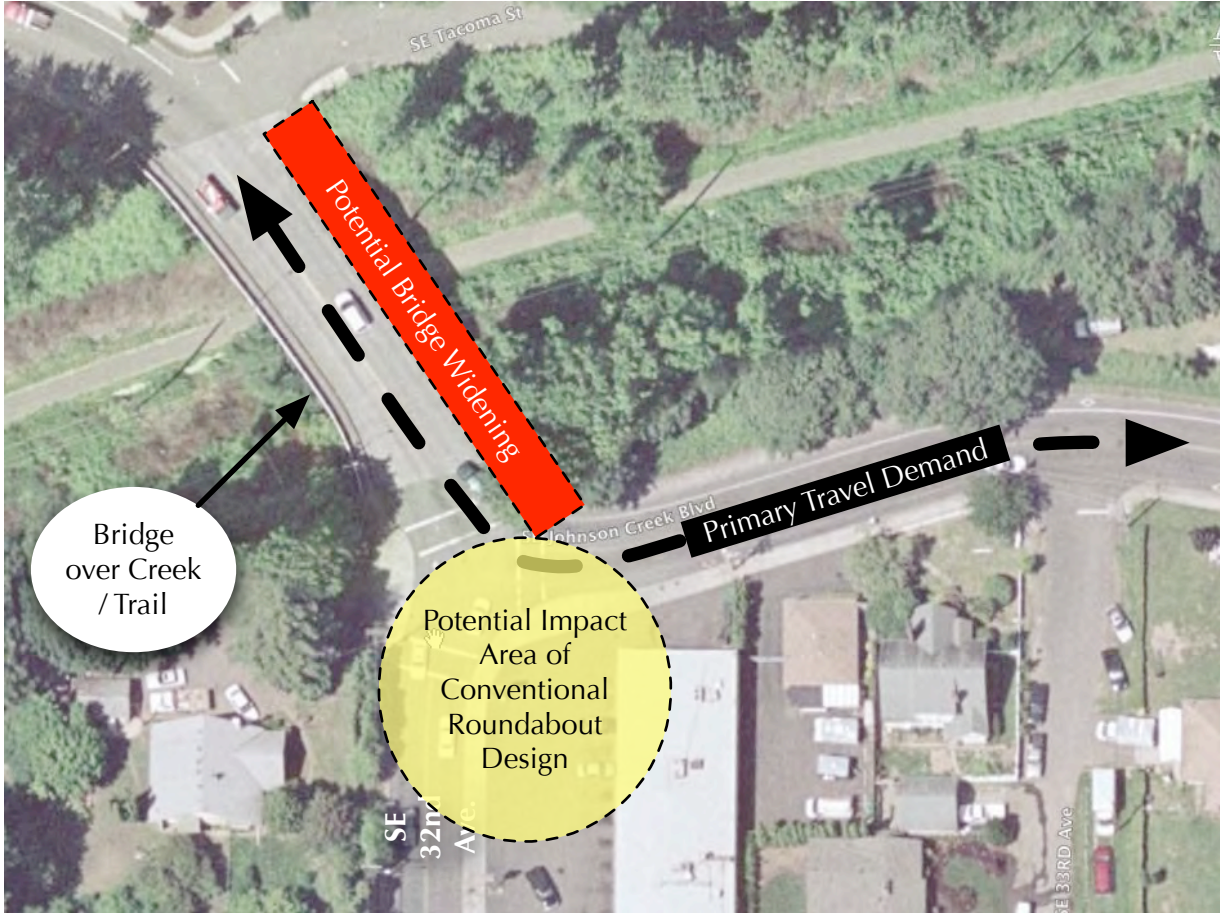
Measure of Effectiveness	Alt. 1: Reconfigure Existing Intersection	Alt. 2: Modify LOS Policy
Traffic Operations City standard = LOS D	Re-stripe Harrison Ave. approaches to provide space for right-turn lanes. Lanes line up with next block downstream.	No change
Safety	More lanes crossing crosswalk; could degrade pedestrian safety	No change
Cost	\$	\$
PREFERRED		

2. SE Harrison Ave. / SE 42nd Avenue



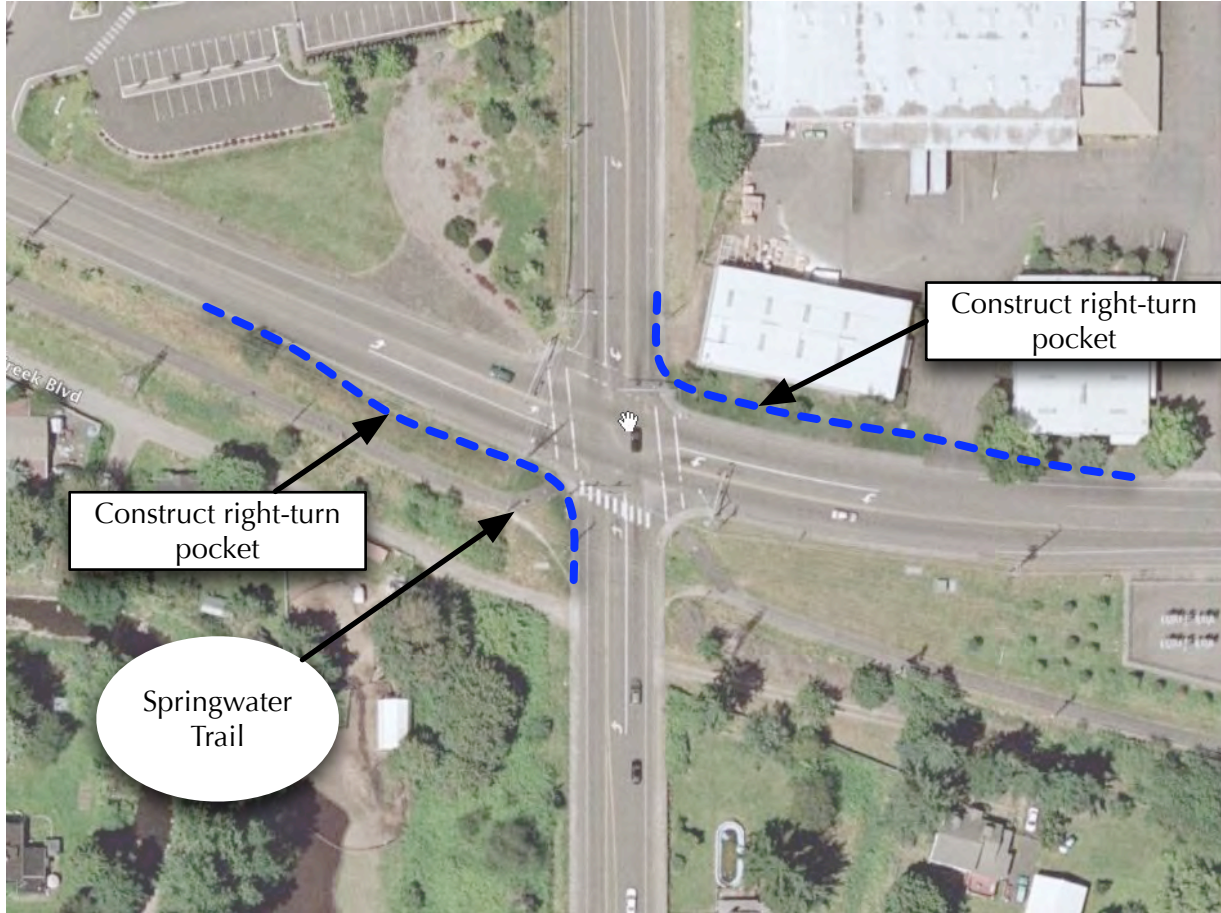
Measure of Effectiveness	Alt. 1: Do Nothing	Alt. 2: Install Traffic Signal	Alt. 3: Re-direct Through Route Traffic & Signals
Traffic Operations City Standard = LOS D	Significant vehicle queues and delays for major approaches (SB 42nd and EB Harrison) during peak hours.	Install traffic and pedestrian signals. No street widening required.	Install traffic and pedestrian signals. Modify Harrison / 42nd and King / 42nd to favor through route.
Safety	No change.	Pedestrian crossings should be safer and more convenient during peak hours.	Curb extensions on minor legs would shorten crossing area for pedestrians, and help to indicate through route.
Cost	None.	\$\$	\$\$\$

3. SE Johnson Creek Blvd. / SE 32nd Avenue



Measure of Effectiveness	Alt. 1: Roundabout	Alt. 2: Traffic Signal
Traffic Operations Portland Standard = LOS D	Design roundabout at existing intersection. Requires property acquisition and impacts to private building.	Install traffic and pedestrian signals at existing intersection. Requires additional EB approach lane beginning west of bridge and possible bridge widening
Safety	Effective design would substantially reduce vehicle queues and blockage of minor side streets. Proximity to bridge makes design more complex.	Effective design would reduce delays and vehicle queues.
Cost	\$\$\$	\$\$\$

4. SE Johnson Creek Blvd. / SE Linwood Avenue



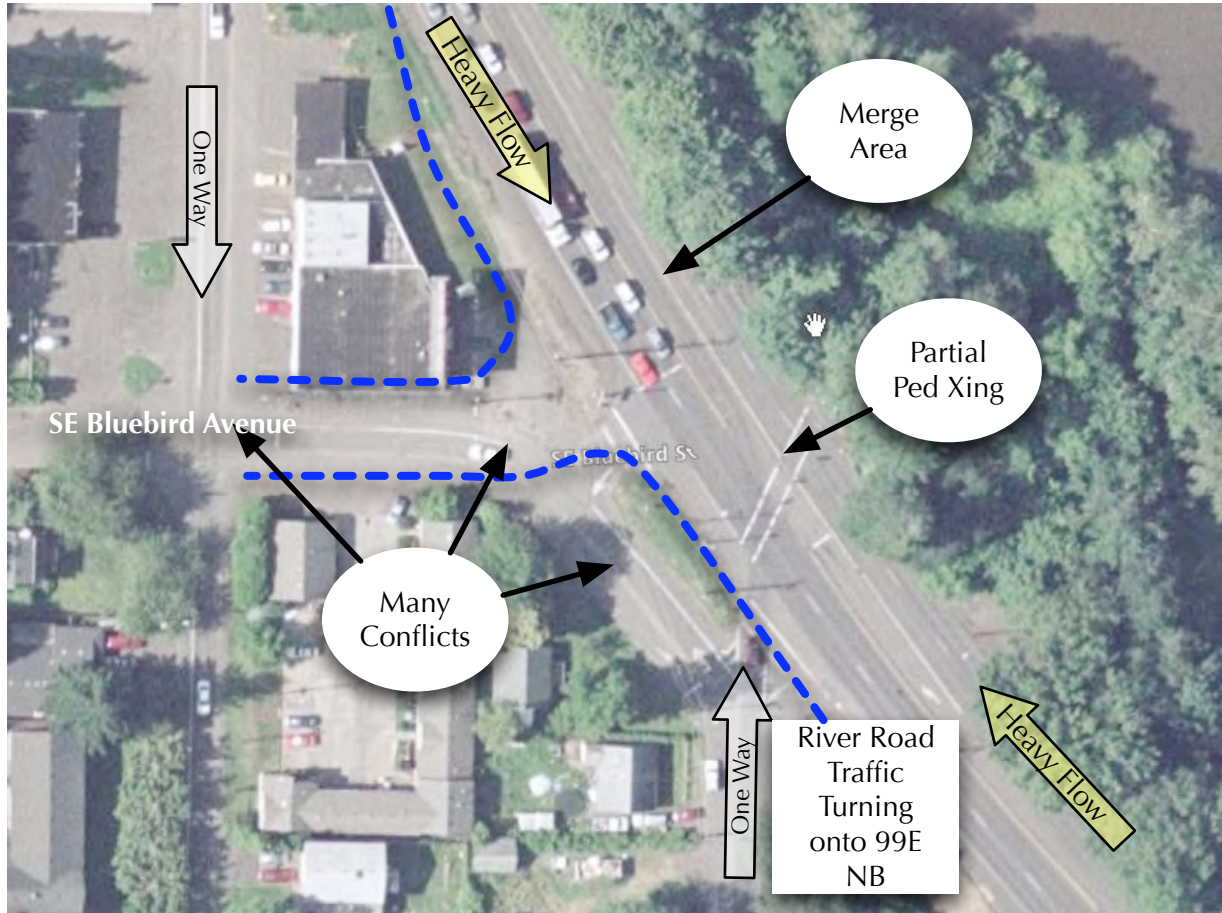
Measure of Effectiveness	Alt. 1: Do Nothing	Alt. 2: Add Right-turn lanes
Traffic Operations Portland Standard = LOS D	2030 conditions drop to LOS E. Vehicle queues and delays during peak hours could be excessive.	Widen JCB approaches to provide for standard right-turn pockets. May need to acquire ROW. Relocate traffic signal poles, as needed.
Safety	No change.	Widening will extend crosswalk lengths and time to cross. Need to integrate for trail crossing on south leg into design.
Cost	None.	\$\$
		PREFERRED

5. SE King Road / SE Linwood Avenue



Measure of Effectiveness	Alt. 1: Modify Traffic Signal Phasing on King Road	Alt. 2: Reduce City LOS Mobility Standard
Traffic Operations City Standard = LOS D	Modify traffic controls to provide protect left-turn (green arrow) and protected left-turn (flashing yellow arrow) on King Road approaches Does not attain LOS D.	Modify city standard to allow for LOS E conditions during peak hours at traffic signals.
Safety	No change	No change
Cost	\$\$	\$
PREFERRED		

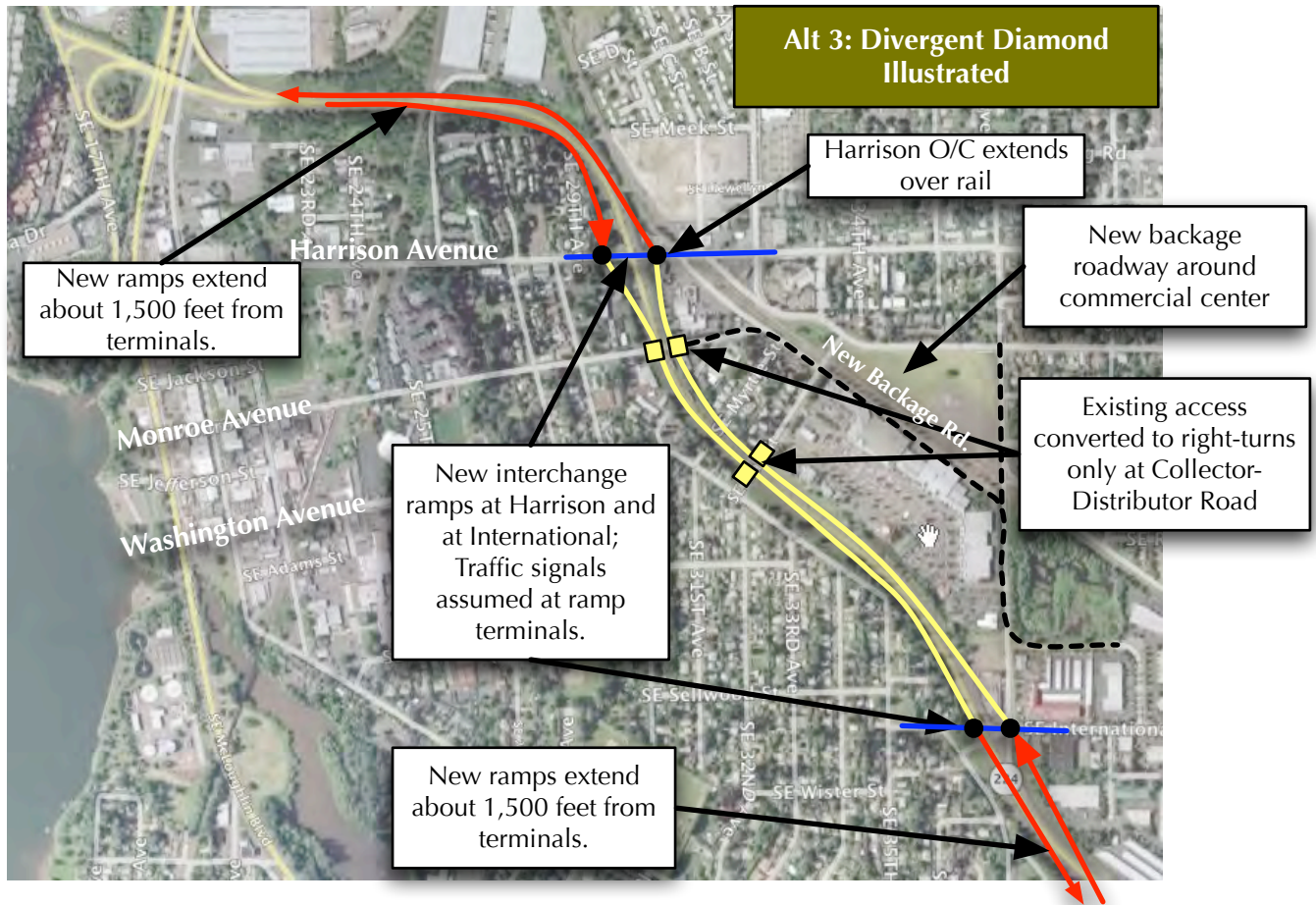
6. ORE 99E / River Road



Measure of Effectiveness	Alt. 1: Reconfigure Existing Intersection	Alt. 2: Reconstruct Intersection	Alt. 3: Defer Decision
Traffic Operations Standard: v/c = 0.99	Widen River /Road approach to add 2nd NB left turn lane	Consolidate 22nd Avenue, River Road & Bluebird legs, possibly acquire building north of Bluebird; shown.	Make no specific recommendations; defer improvement plan to other ODOT studies underway.
Safety	Re-design NB River Road approach to move Ped Xing to full signal control; Make NB 99E traffic stop at signal	Make conventional intersection near existing Bluebird Lane connection.	No change
Cost	\$\$	\$\$\$	

All projects on state facilities require review and approval by ODOT.

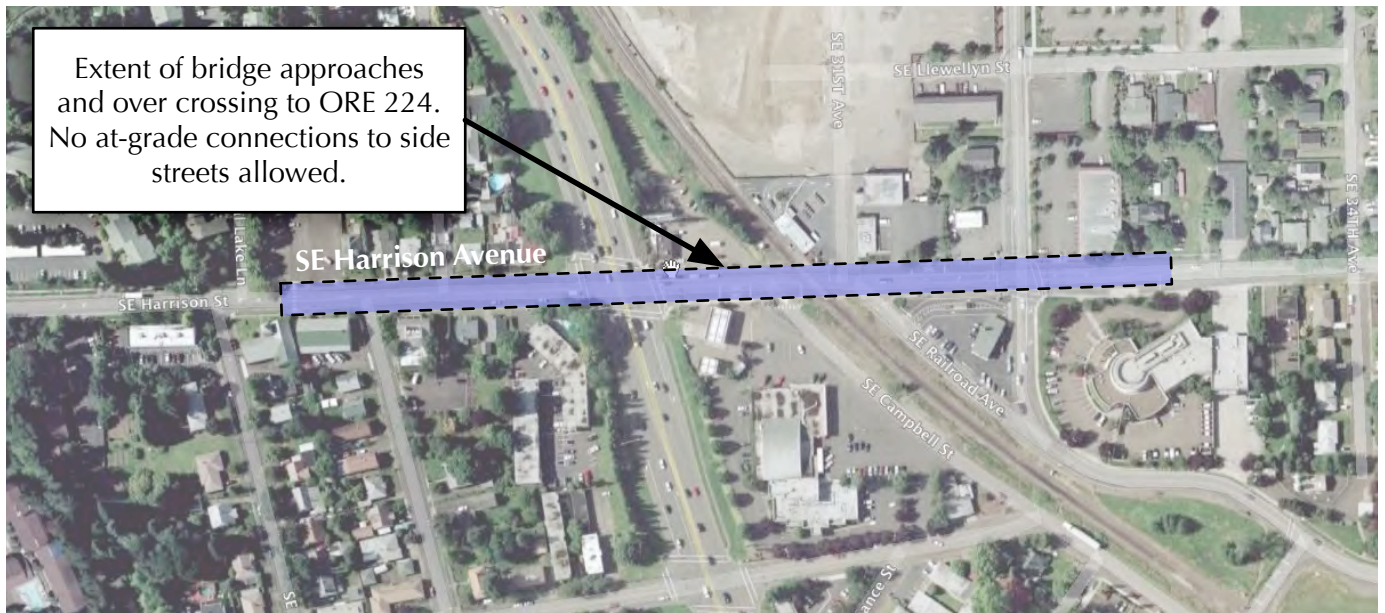
7. ORE 224 / Harrison to Oak



Measure of Effectiveness	Alt. 1: 7-Lane ORE 224	Alt. 2: 7-Lanes Plus Harrison O/C	Alt. 3: Divergent Diamond
Traffic Operations ODOT Standard = v/c 0.99	Complies with Mobility standards for highway traffic; status quo for cross-city travel	Less interruptions of ORE 224; superior circulation for cross-city trips on Harrison	Construct freeway ramps and collector distributor roads (yellow); Construct over (under) crossings to highway at Harrison and at International. Construct backage road from 37th to Monroe for commercial area.. Limit access at Monroe and Oak to new C-D road.
Safety	Extends pedestrian and bike crossing length; same barrier issues as today.	Provide grade separated crossing option for non-auto travel. Better safety and less delays.	Provides two grade separated crossings. Would need access management plan on city street approaches to I/C
Cost	\$\$\$	\$\$\$	\$\$\$\$

All projects on state facilities require review and approval by ODOT.

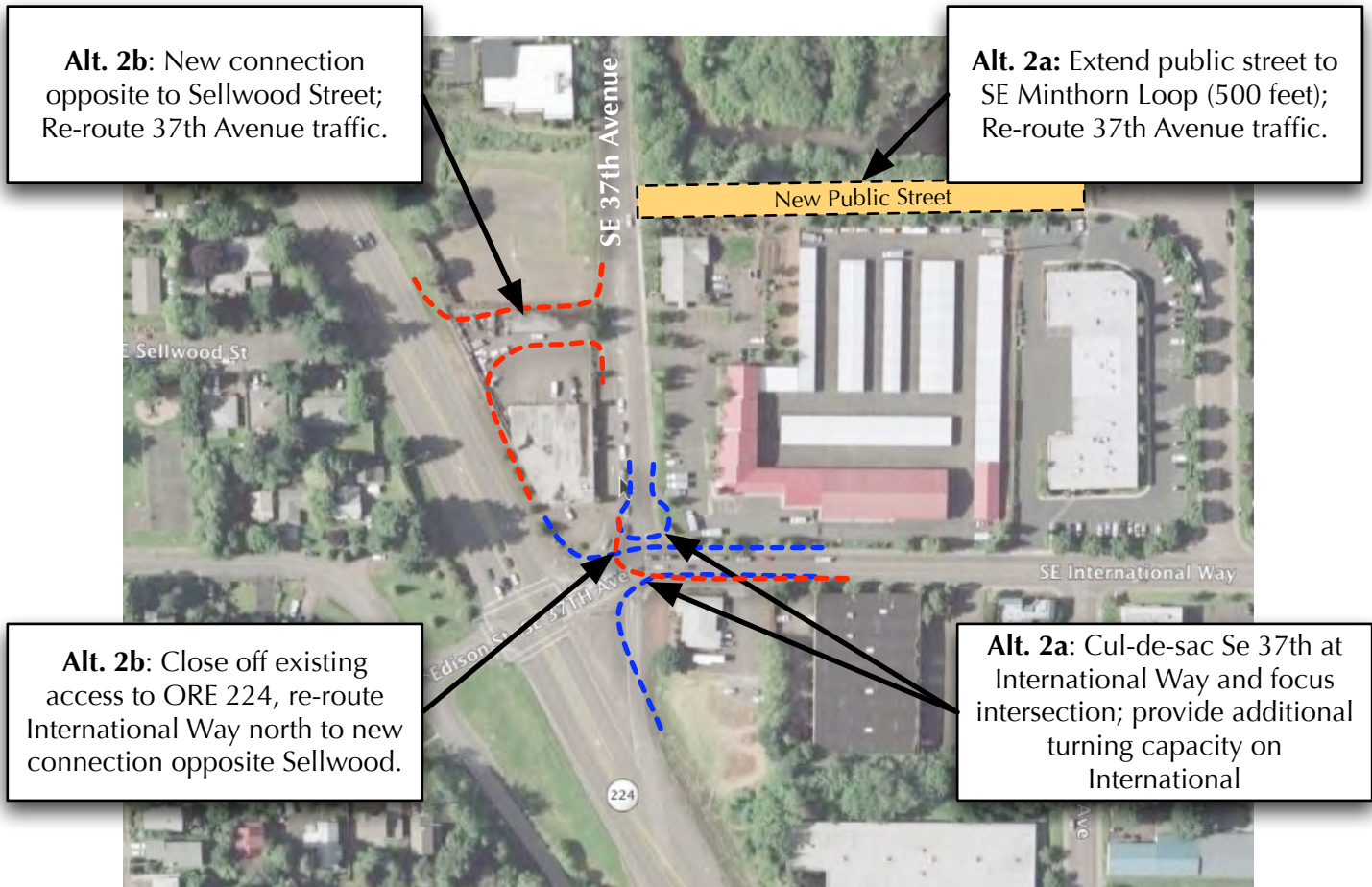
8. Harrison Avenue / ORE 224



Measure of Effectiveness	Alt. 1: At-Grade	Alt. 2: Cross Over ORE 224 with No Ramps
Traffic Operations ODOT Standard = v/c 0.99	Assumes seven-lane section on ORE 224. Complies with minimum mobility standard.	Removal of at-grade intersection and access to King Road. Highway operates same as mainline section.
Safety	Wider approaches on ORE 224 extend crossing times for pedestrians and bikes.	Uninterrupted flow of pedestrians and bikes to either side of city. Bridge structure would also cross RR tracks.
Cost	\$\$\$	\$\$\$

All projects on state facilities require review and approval by ODOT.

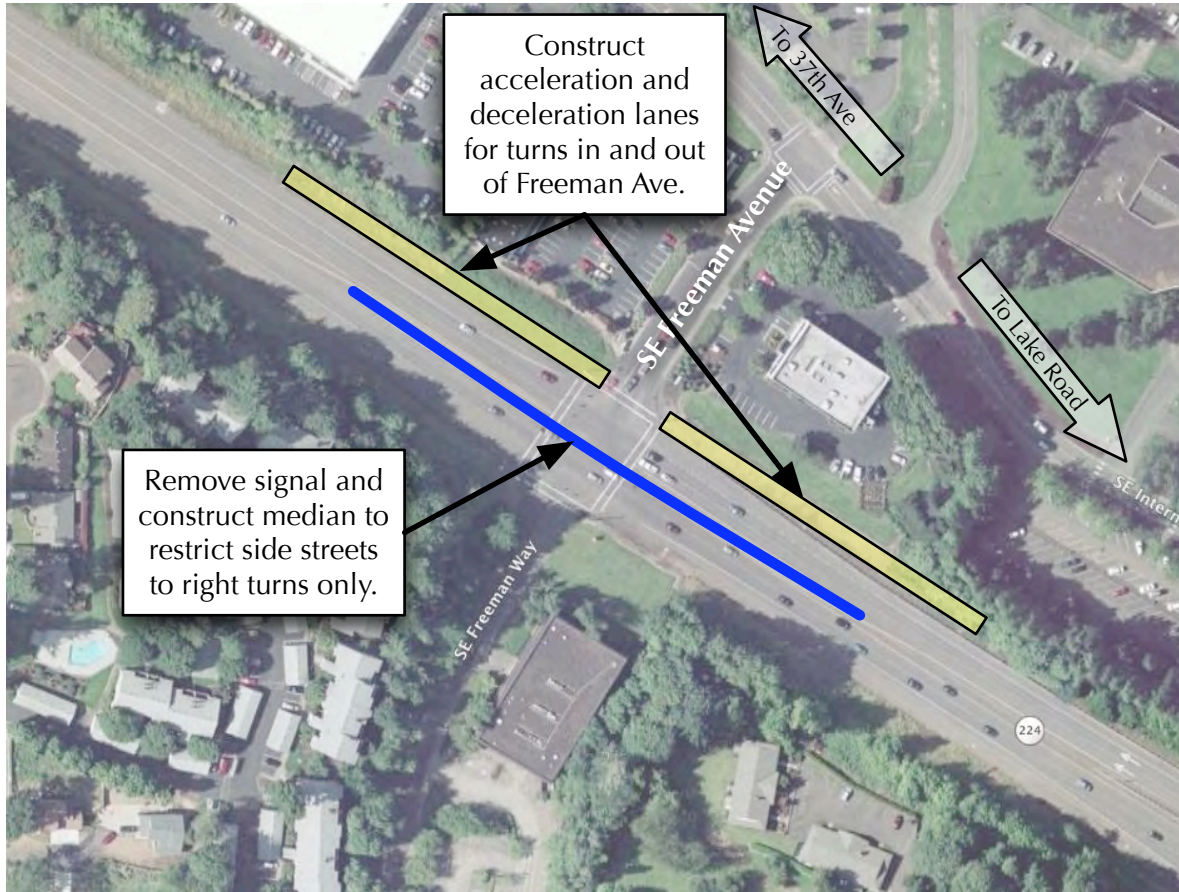
9. International Way - 37th Ave. / ORE 224



Measure of Effectiveness	Alt. 1: Do Nothing	Alt. 2a: Re-Route 37th Connection	Alt. 2b: Re-Route International Way Connection
Traffic Operations ODOT Standard = v/c 0.99	Highway marginally exceeds peak hour standard (1.05)	The reconfigured intersection more efficient. Extension of Winthrop impacts wetlands area. Could add turn lanes on International Way.	The reconfigured intersection more efficient. Primary connection to 37th Ave. Re-route of International Way traffic north.
Safety	High level of conflicts with two closely spaced full access intersections. Vehicle queues and truck operations compound safety issues.	Significant safety improvements for autos, trucks and pedestrians.	Significant safety improvements for autos, trucks and pedestrians.
Cost	None	\$\$\$	\$\$

All projects on state facilities require review and approval by ODOT.

10. ORE 224 / SE Freeman Avenue



Measure of Effectiveness	Alt. 1: Do Nothing	Alt. 2: Restrict Access on Freeman to Right-turns only
Traffic Operations ODOT Standard = v/c 0.99	Exceeds highway maximum congestion level (1.12 during peak hours..	Eliminating traffic signal would reduce interruptions for regional and freight traffic; some local traffic re-routed to Lake Rd. or Edison or 37th
Safety	No change	Vehicle conflicts and safety should be improved. Removal of pedestrian facilities could reduce safety.
Cost	None	\$\$

All projects on state facilities require review and approval by ODOT.

MEMORANDUM

DATE: August 3, 2007

TO: Freight Working Group, City of Milwaukie

FROM: Alan Snook, AICP
Michael Tomasini, E.I.T.

SUBJECT: **Milwaukie TSP Update Task 8 Freight Access Alternatives** P06097x008x008

The purpose of this Memorandum is to outline different freight access alternatives for the northern industrial area in the City of Milwaukie. An alternatives analysis was done to look at the potential impacts to freight operations resulting from different combinations of access management, bridge construction and roadway realignment projects, as well as the impact of two potential light rail transit (LRT) alignments. This memorandum contains a short description of the methodology used to compare the quantitative and qualitative impacts of each alternative, a brief account of the common themes between each alternative, and an overview of the special aspects of each alternative and an evaluation matrix which compares the alternatives based on criteria developed earlier in the evaluation phase of this project.

Study Area and Methodology

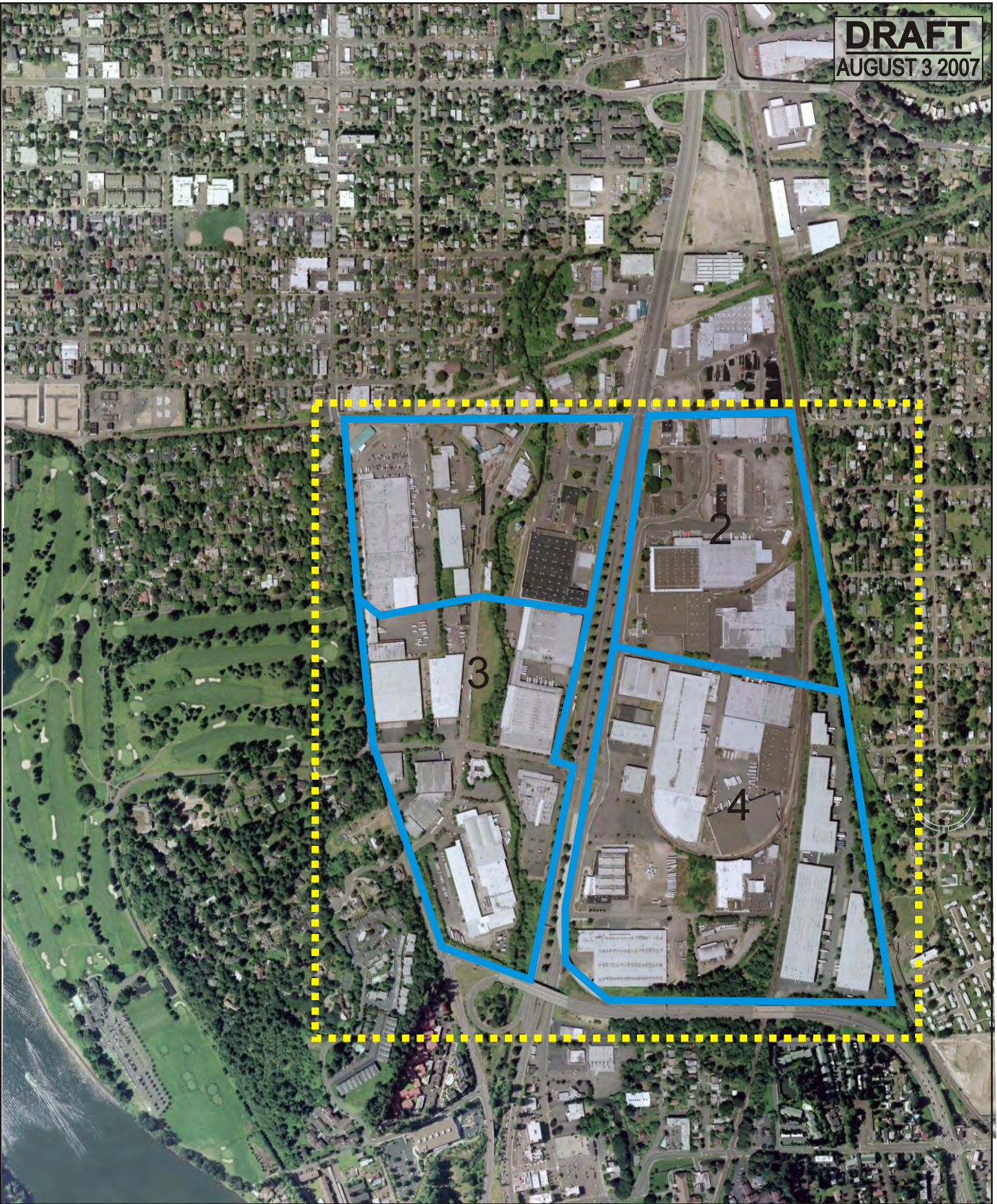
A total of nine alternatives were looked at for this analysis and a study area included the city's northern industrial lands. The northern industrial area of Milwaukie is bounded by the city's northern city limit, Highway 224 to the south, the Tillamook Line railroad tracks to the east and 17th Avenue to the west. Figure 1 shows the study area in relation to surrounding regional facilities, such as SE McLoughlin Boulevard (Highway 99E) and Highway 224.

Although nine alternatives were analyzed, there were, in essence four main alternatives, A, B, C, and D, which contained different roadway alignment options and/or a slight modification to the alternative alignment. The remaining five alternatives came about as a result of having two light rail alignment options. Therefore, each main alternative was analyzed twice, once with the Locally Preferred Alternative (LPA) light rail alignment and a second time with the Tillamook Branch alignment. The exception to this is with Alternate B, in which the LPA option was analyzed with two different roadway alignment options.

1400 SW Fifth Avenue
Suite 500
Portland, OR 97201

(503) 243-3500
(503) 243-1934 fax
www.dksassociates.com

DRAFT
AUGUST 3 2007



-Study Area



1

-Study Sub Area



Information Sources: *DKS Associates*

STUDY AREA

FIGURE
1

For each alternative, key criteria were analyzed, including:

- Freight operations;
- Traffic throughput on SE McLoughlin Boulevard (Highway 99E);
- Local side street traffic operations, access, crossing improvements, and safety;
- Resource limitations;
- Out of direction travel;
- Pedestrian connectivity;
- Bicycle connectivity;
- Transit access/egress and conflicts; and
- Robustness of the alternative.

Synchro traffic analysis software was used to measure the effects of the different roadway alignments and the impact of the light rail operations for many of the qualitative criteria, such as traffic and freight operations. ArcGIS (Geographic Information Systems) software was used in part to measure the amount of out of direction travel that would be experienced for each subgroup within the study area. While engineering judgment was used for the remaining qualitative criteria (side street crossing, safety, bicycle and pedestrian connectivity, and transit access/egress and conflicts), a quantitative assessment was conducted for the other criteria. All of the data from the technical analysis for each alternative is located in the Freight Technical Appendix.

Alternatives Described

The following gives a brief description of each alternative that was developed and analyzed for this assessment.

Alternates A1 and A2

The only difference between alternates A1 (LPA LRT) and A2 (Tillamook LRT), as can be seen in Figures A1 and A2 are the LRT alignments. The main themes for Alternates A1 and A2 are the construction of an overpass at SE Ochoco Street with auxiliary lanes connecting SE Ochoco Street to SE McLoughlin Boulevard and the complete closure of the SE McLoughlin Boulevard/SE Milport Road intersection for all movements except through traffic on SE McLoughlin Boulevard. As a result of this closure, the intersection of SE Milport Road/SE Main Street would also be closed, leaving SE Main Street as a through street. SE Frontage Road would be converted to a cul-de-sac at the north and the intersection of SE Milport Road/SE Frontage Road would be turned into a through street. The intersection of SE Ochoco Street/SE Main Street would be closed and SE Main Street would be converted to cul-de-sacs on either side of SE Ochoco Street. Finally, a new roadway extension of SE 25th Avenue would connect SE Main Street to SE Ochoco Street.

Alternates B1, B2, and B1a

Alternates B1 and B2 are similar to the “A” Alternates in that they involve the construction of an overpass for SE Ochoco Street with auxiliary lanes accessing SE McLoughlin Boulevard. The difference is that the auxiliary lanes are located further north of the overpass, and the auxiliary lane for southbound traffic on SE McLoughlin Boulevard connects with SE Frontage Road and does not require this roadway to become a cul-de-sac. Furthermore, the intersection of SE Ochoco Street/SE Main Street

remains open and the intersection of SE McLoughlin Boulevard/SE Milport Road is only subject to a partial closure. Through movements on SE McLoughlin Boulevard and right turning traffic would be allowed to access SE McLoughlin Boulevard from SE Milport Road.

Alternates B1 and B2 differ only by the LRT alignment. Alternate B1a and B1 both have the LPA LRT alignment, their only difference is in the road network. The auxiliary lane in Alternate B1a connects with SE McBrod Avenue instead of SE Frontage Road. A cul-de-sac is also created at SE Frontage Road in this alternative. Figures B1, B1a, and B2 show the alignments for the different alternatives.

Alternates C1 and C2

Alternates C1 and C2 would include the construction of a Highway 224 overpass with Highway 224 being grade separated from the full access intersection of SE McLoughlin Boulevard/SE Milport Road. The intersection of SE Milport Road/SE Main Street would be moved and SE Main Street would be realigned to allow for more storage space and increased intersection spacing. Auxiliary lanes would be constructed to allow right-in/right-out access from north of SE Ochoco Street (SE Moores Street). The partial closure of the intersection of SE McLoughlin Boulevard/SE Ochoco Street would only allow north/south through movements on SE McLoughlin Boulevard. These alternatives can be seen in Figures C1 and C2.

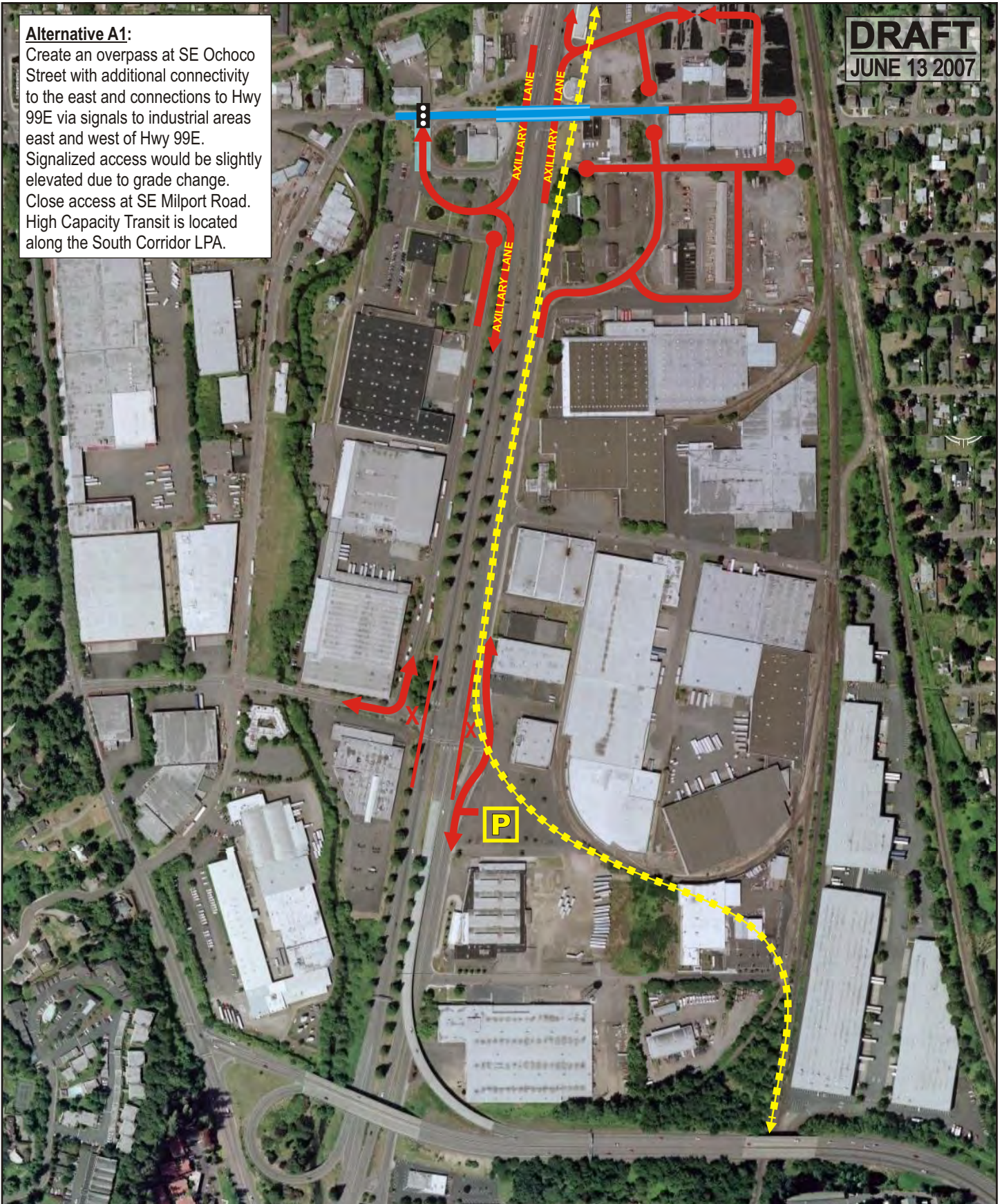
Alternates D1 and D2

The “D” Alternatives would include the construction of an overpass of SE McLoughlin Boulevard at SE Ochoco Street with no direct access to SE McLoughlin Boulevard. The intersection of SE McLoughlin Boulevard/SE Milport Road would be converted into a full access intersection with. A cul-de-sac would be constructed at the southern end of SE Frontage Road, and the intersection of SE Milport Road/SE Frontage Road would be closed to access onto SE Frontage Road. As with Alternate C1 and C2, the intersection of SE Milport Road/SE Main Street would be moved to the southeast and SE Main Street would be realigned to allow for increased intersection spacing and increased storage length for both of the “D” Alternatives. Figures D1 and D2 show the proposed roadway alignments for both alternatives.

DRAFT
JUNE 13 2007

Alternative A1:

Create an overpass at SE Ochoco Street with additional connectivity to the east and connections to Hwy 99E via signals to industrial areas east and west of Hwy 99E. Signalized access would be slightly elevated due to grade change. Close access at SE Milport Road. High Capacity Transit is located along the South Corridor LPA.



LEGEND

- - At-grade Roadway
- - Elevated Roadway
- Elevated Area
- Potential High Capacity Transit
- P - Park-and-Ride
- ⦿ - Full Access Signal
- X - Closed Roadway



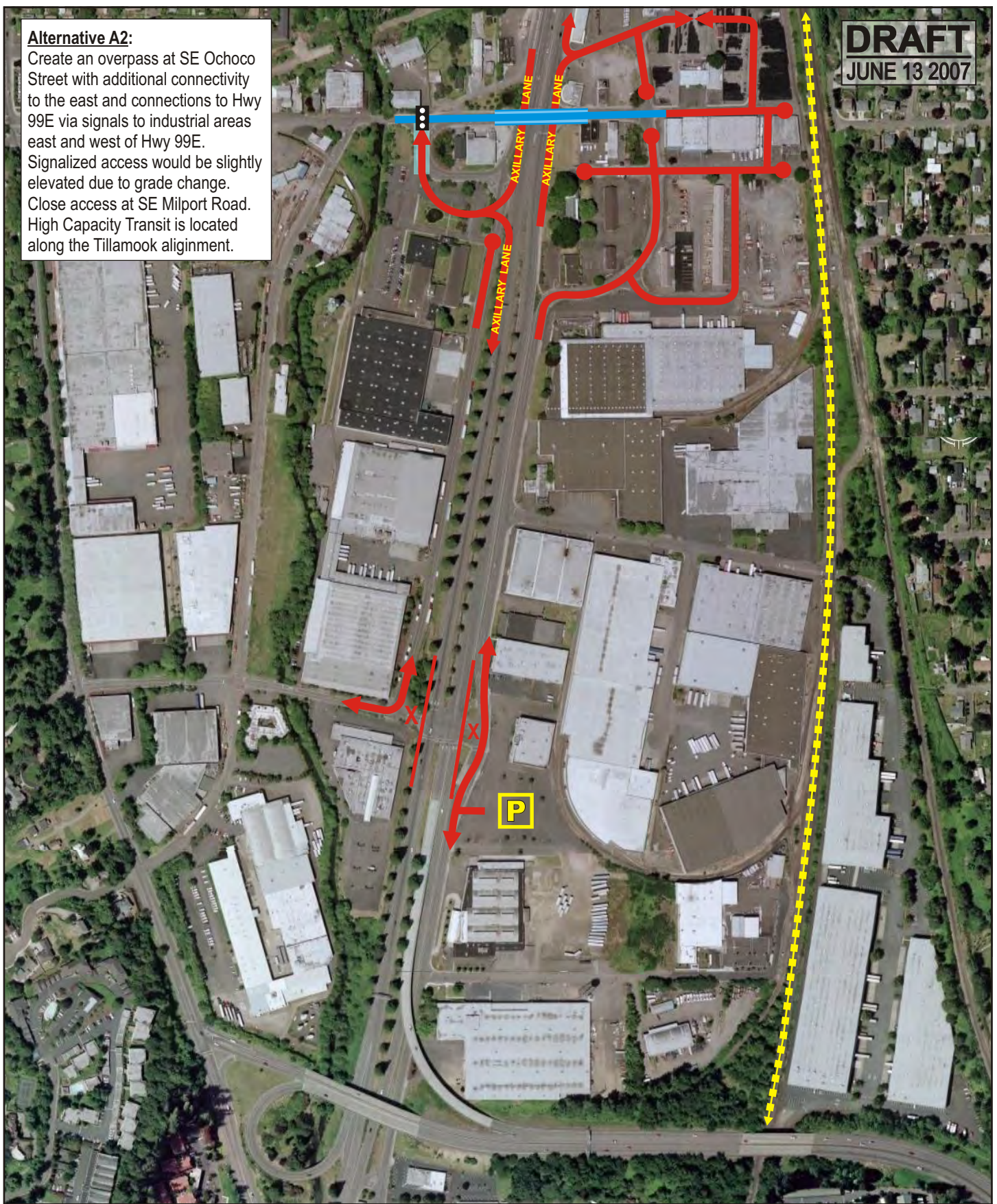
Information Sources: *DKS Associates*

**FREIGHT ACCESS
ALTERNATIVE A1**








**FIGURE
A1**

DRAFT
JUNE 13 2007

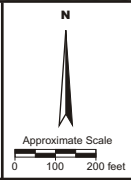
Alternative A2:
Create an overpass at SE Ochoco Street with additional connectivity to the east and connections to Hwy 99E via signals to industrial areas east and west of Hwy 99E. Signalized access would be slightly elevated due to grade change. Close access at SE Milport Road. High Capacity Transit is located along the Tillamook alignment.



LEGEND

-  - At-grade Roadway
-  - Elevated Roadway
-  - Elevated Area
-  - Potential High Capacity Transit
-  - Full Access Signal
-  - Closed Roadway
-  - Park-and-Ride

Information Sources: *DKS Associates*



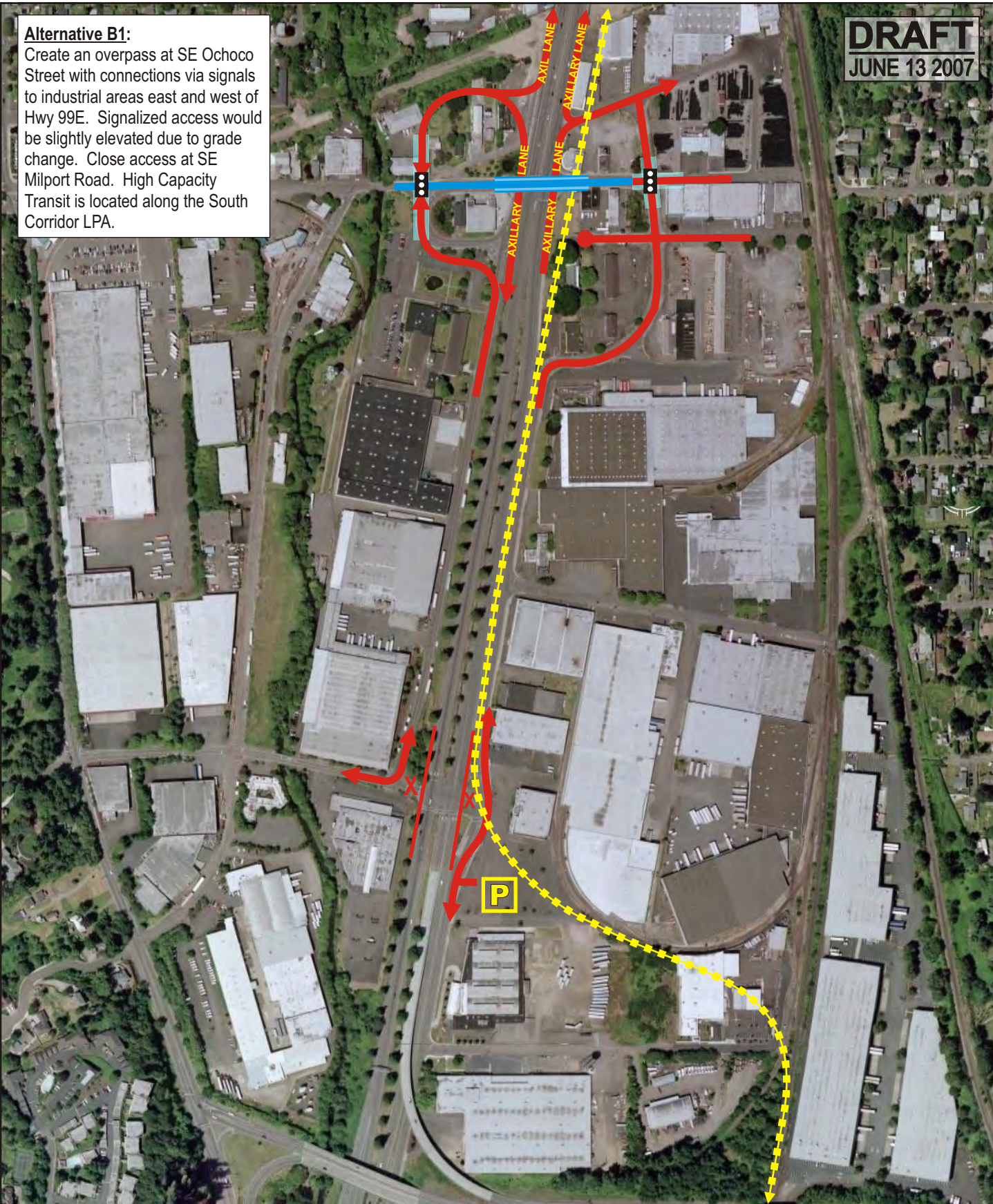
**FREIGHT ACCESS
ALTERNATIVE A2**

**FIGURE
A2**

DRAFT
JUNE 13 2007

Alternative B1:

Create an overpass at SE Ochoco Street with connections via signals to industrial areas east and west of Hwy 99E. Signalized access would be slightly elevated due to grade change. Close access at SE Milport Road. High Capacity Transit is located along the South Corridor LPA.



LEGEND

- - At-grade Roadway
- - Elevated Roadway
- Elevated Area
- Potential High Capacity Transit

- - Full Access Signal
- X - Closed Roadway
- P - Park-and-Ride



Information Sources: *DKS Associates*

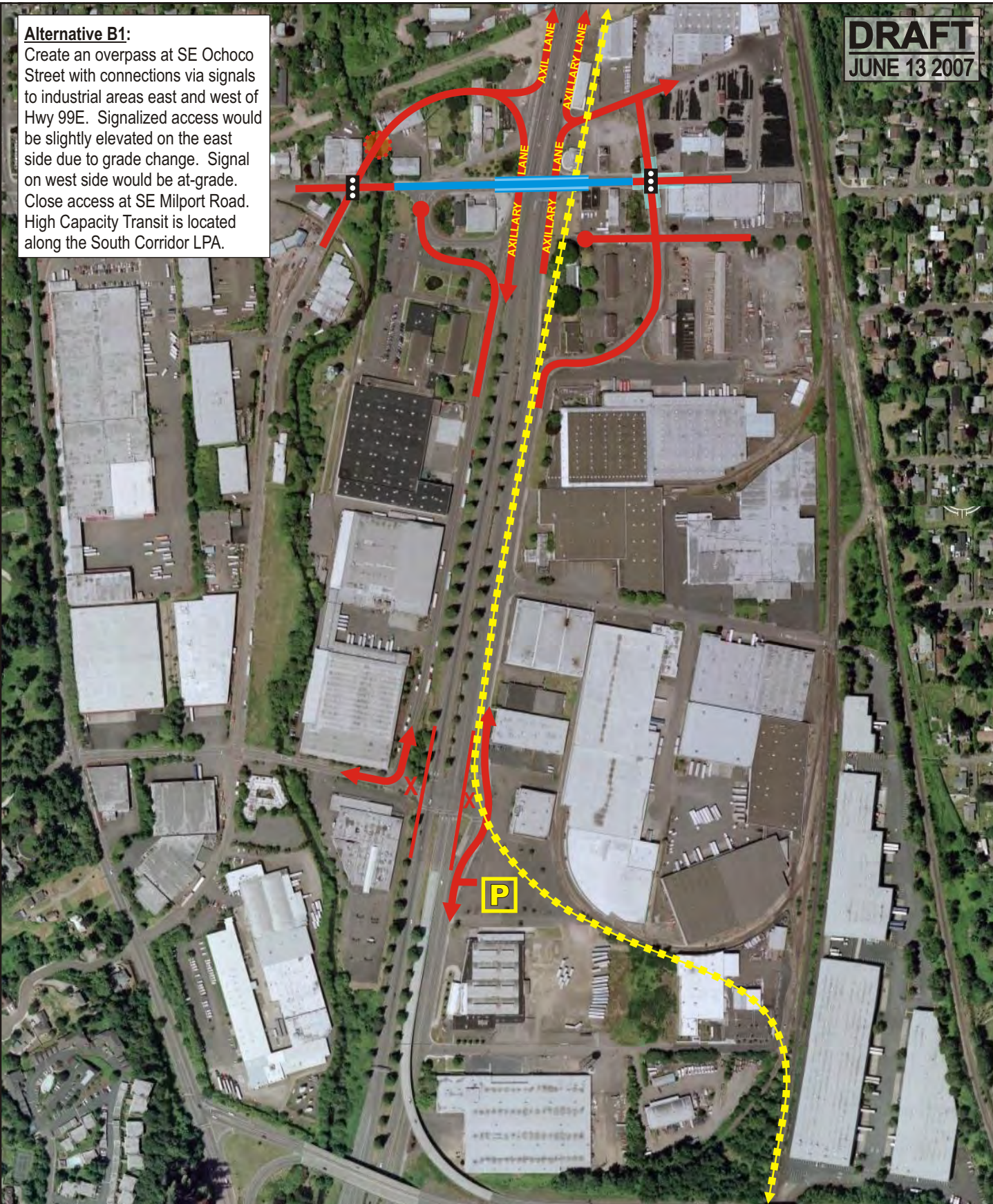
**FREIGHT ACCESS
 ALTERNATIVE B1**

**FIGURE
 B1**









DRAFT
JUNE 13 2007

Alternative B1:

Create an overpass at SE Ochoco Street with connections via signals to industrial areas east and west of Hwy 99E. Signalized access would be slightly elevated on the east side due to grade change. Signal on west side would be at-grade. Signal access at SE Milport Road. Close access at SE Milport Road. High Capacity Transit is located along the South Corridor LPA.



LEGEND

-  - At-grade Roadway
-  - Elevated Roadway
-  - Elevated Area
-  - New Crossing Over Creek
-  - Full Access Signal
-  - Closed Roadway
-  - Park-and-Ride
-  - Potential High Capacity Transit



Information Sources: *DKS Associates*

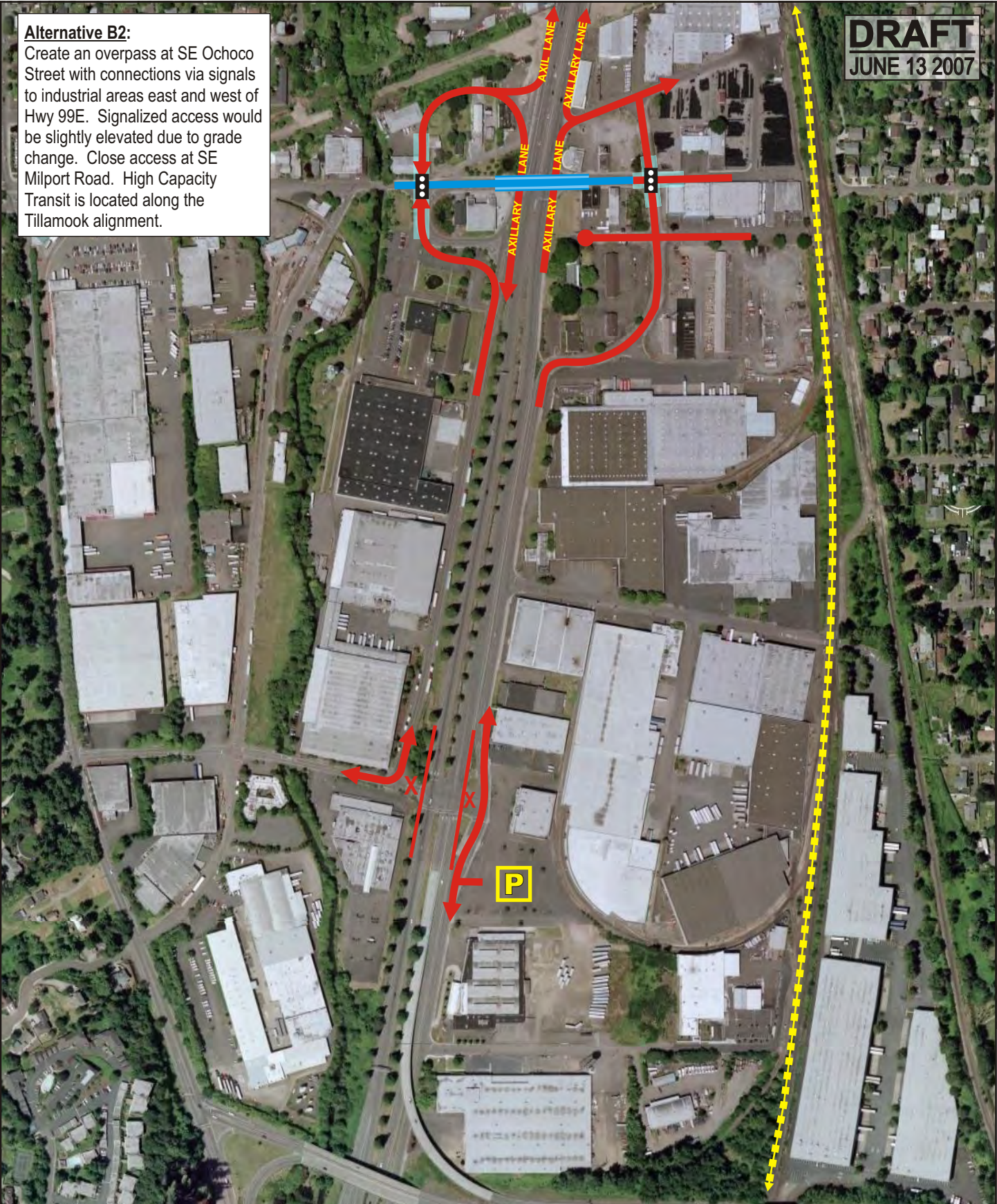
**FREIGHT ACCESS
 ALTERNATIVE B1a**

**FIGURE
 B1a**

DRAFT
JUNE 13 2007

Alternative B2:

Create an overpass at SE Ochoco Street with connections via signals to industrial areas east and west of Hwy 99E. Signalized access would be slightly elevated due to grade change. Close access at SE Milport Road. High Capacity Transit is located along the Tillamook alignment.



LEGEND

- At-grade Roadway
- Elevated Roadway
- Elevated Area
- Potential High Capacity Transit

- Full Access Signal
- Closed Roadway
- Park-and-Ride



Information Sources: *DKS Associates*

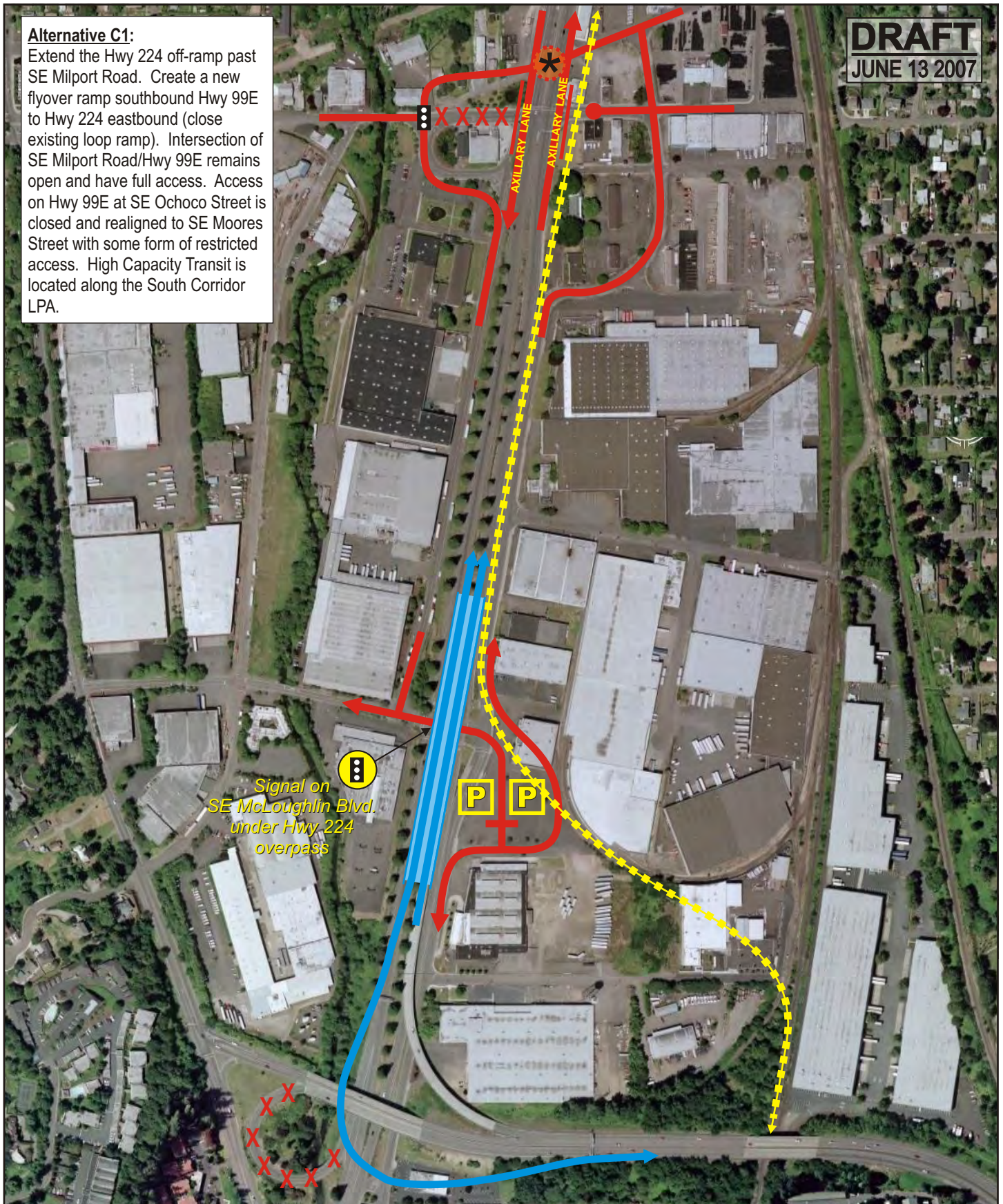
**FREIGHT ACCESS
ALTERNATIVE B2**

**FIGURE
B2**

DRAFT
JUNE 13 2007




Alternative C1:


Extend the Hwy 224 off-ramp past SE Milport Road. Create a new flyover ramp southbound Hwy 99E to Hwy 224 eastbound (close existing loop ramp). Intersection of SE Milport Road/Hwy 99E remains open and have full access. Access on Hwy 99E at SE Ochoco Street is closed and realigned to SE Moores Street with some form of restricted access. High Capacity Transit is located along the South Corridor LPA.



Signal on
SE McLoughlin Blvd.
under Hwy 224
overpass

LEGEND

-  - At-grade Roadway
-  - Elevated Roadway
-  - Elevated Area

 - Restricted Access Intersection
(Right-in/Right-out, No Access,
Right-in, Closed, Overpass)

 - Full Access Signal

 - Closed Roadway

 - Park-and-Ride

 - Potential High Capacity Transit



Information Sources: *DKS Associates*

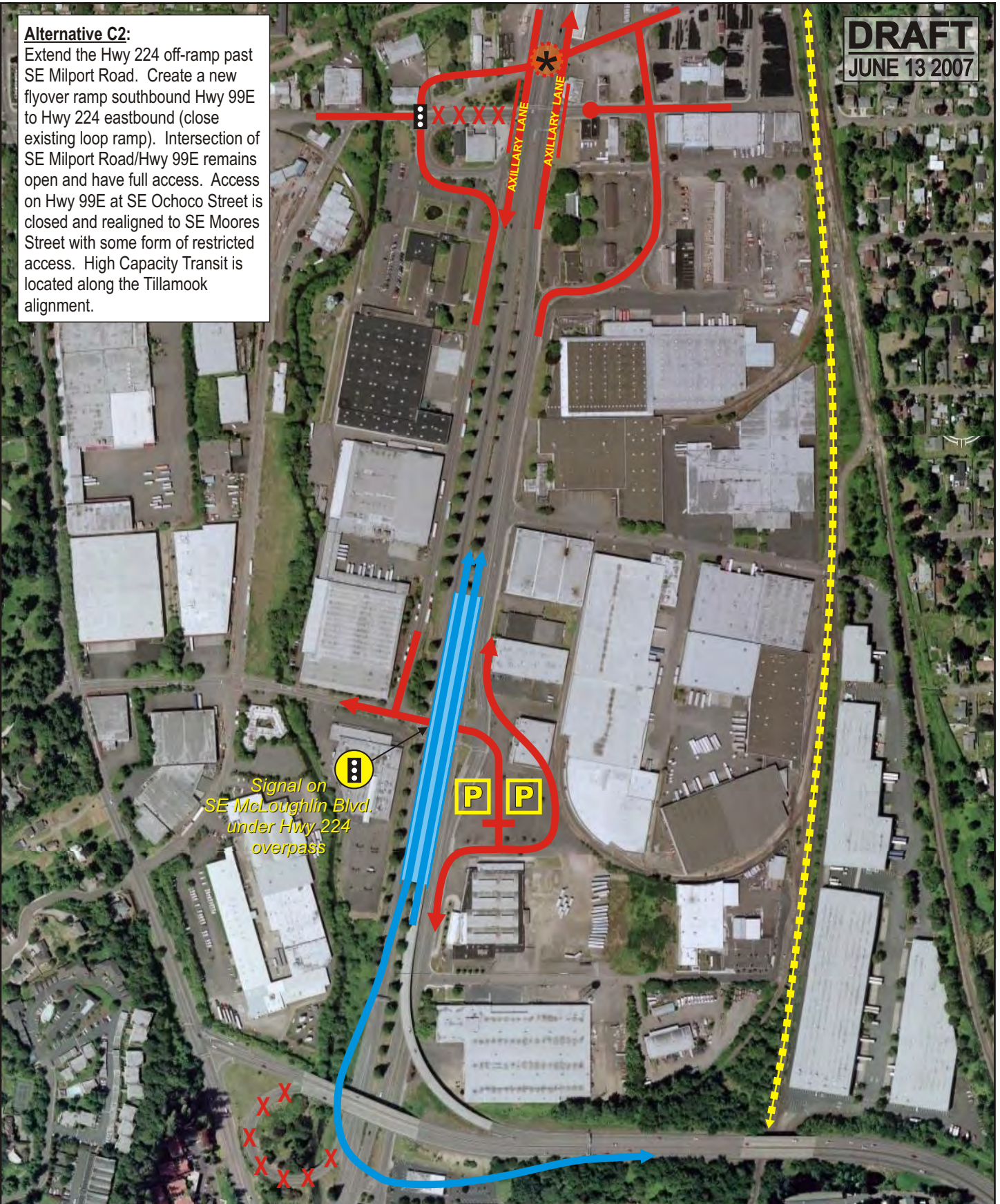
**FREIGHT ACCESS
ALTERNATIVE C1**

**FIGURE
C1**

DRAFT
JUNE 13 2007

Alternative C2:

Extend the Hwy 224 off-ramp past SE Milport Road. Create a new flyover ramp southbound Hwy 99E to Hwy 224 eastbound (close existing loop ramp). Intersection of SE Milport Road/Hwy 99E remains open and have full access. Access on Hwy 99E at SE Ochoco Street is closed and realigned to SE Moores Street with some form of restricted access. High Capacity Transit is located along the Tillamook alignment.



Signal on SE McLoughlin Blvd. under Hwy 224 overpass

LEGEND

- - At-grade Roadway
- - Elevated Roadway
- Elevated Area

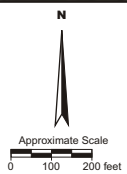
- Restricted Access Intersection (Right-in/Right-out, No Access, Right-in, Closed, Overpass)

- Full Access Signal

X - Closed Roadway

- Park-and-Ride

- - - - Potential High Capacity Transit



Information Sources: *DKS Associates*

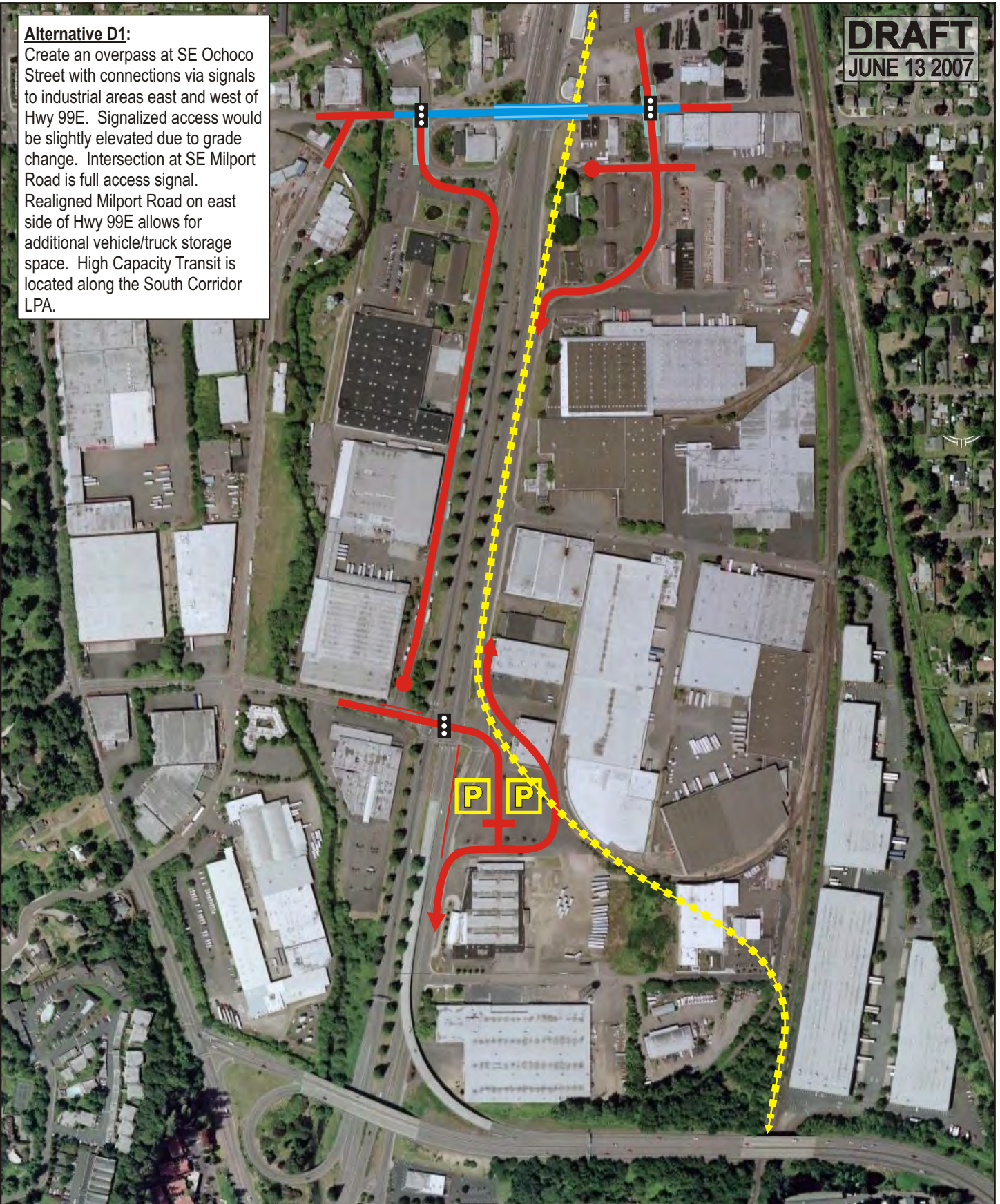
**FREIGHT ACCESS
ALTERNATIVE C2**

**FIGURE
C2**

DRAFT
JUNE 13 2007

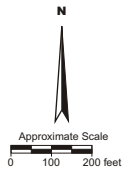
Alternative D1:

Create an overpass at SE Ochoco Street with connections via signals to industrial areas east and west of Hwy 99E. Signalized access would be slightly elevated due to grade change. Intersection at SE Milport Road is full access signal. Realigned Milport Road on east side of Hwy 99E allows for additional vehicle/truck storage space. High Capacity Transit is located along the South Corridor LPA.



LEGEND

- - At-grade Roadway
- - Elevated Roadway
- Elevated Area
- Potential High Capacity Transit
- P - Park-and-Ride
- ⋮ - Full Access Signal
- X - Closed Roadway



Information Sources: *DKS Associates*

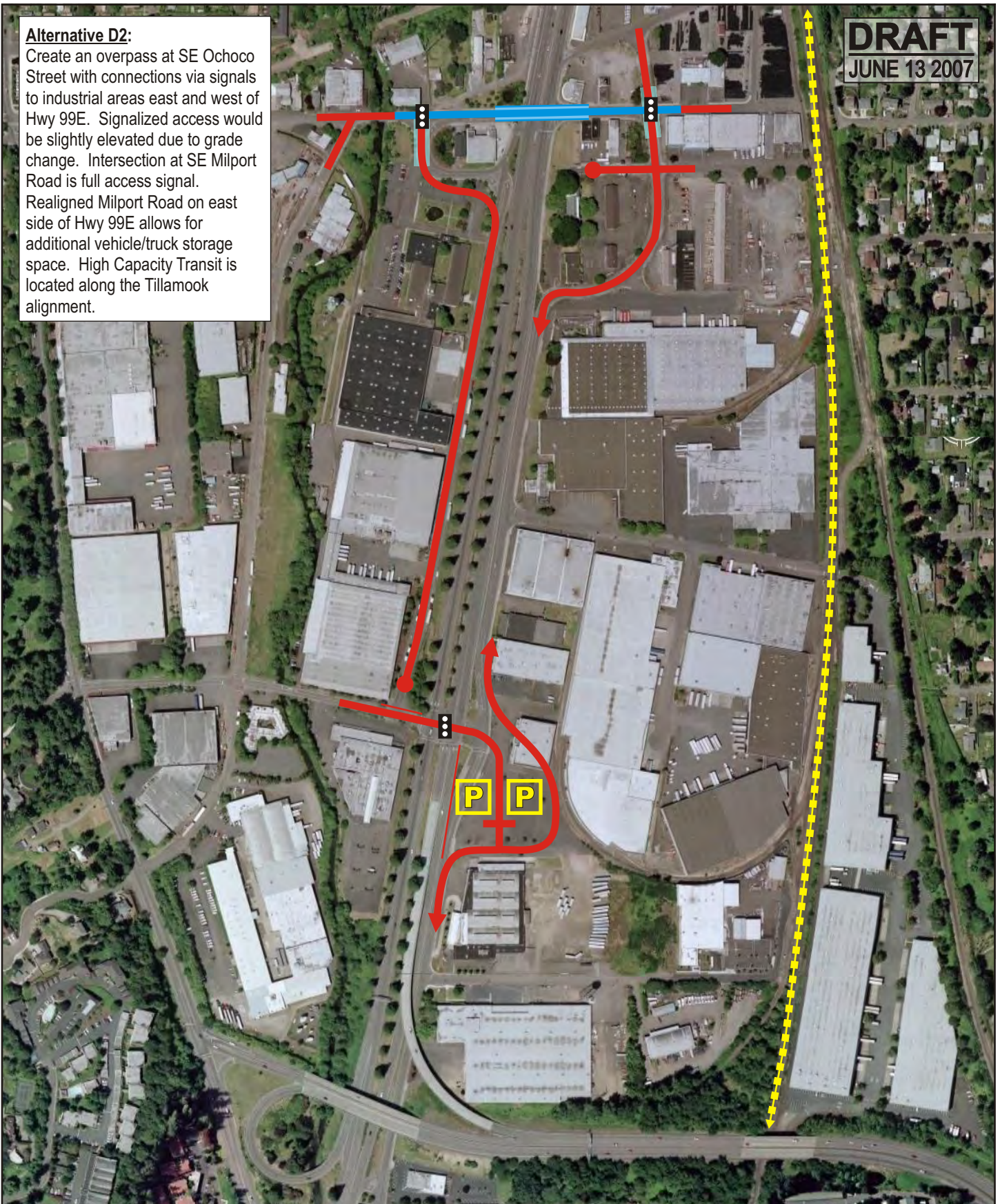
**FREIGHT ACCESS
 ALTERNATIVE D1**

**FIGURE
 D1**





DRAFT
JUNE 13 2007




Alternative D2:

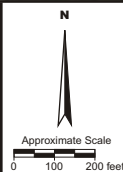
Create an overpass at SE Ochoco Street with connections via signals to industrial areas east and west of Hwy 99E. Signalized access would be slightly elevated due to grade change. Intersection at SE Milport Road is full access signal. Realigned Milport Road on east side of Hwy 99E allows for additional vehicle/truck storage space. High Capacity Transit is located along the Tillamook alignment.



LEGEND

-  - At-grade Roadway
-  - Elevated Roadway
-  - Elevated Area
-  - Potential High Capacity Transit

-  - Full Access Signal
-  - Closed Roadway
-  - Park-and-Ride



Information Sources: *DKS Associates*

**FREIGHT ACCESS
ALTERNATIVE D2**

**FIGURE
D2**

Table 1-1: Freight Evaluation Comparison Matrix

Alternative		A1	A2	B1	B1a	B2	C1	C2	D1	D2
		Ochoco overpass with closure at Milport. LRT on LPA alignment	Ochoco overpass with closure at Milport. LRT on Tillamook alignment	Ochoco overpass with full connection to frontage road. Right-out at Milport. LRT on LPA alignment.	Ochoco overpass with access at McBroad. Right-out at Milport. LRT on LPA alignment.	Ochoco overpass with full connection to frontage road. LRT on Tillamook alignment.	Hwy 224 overpass, full access intersection at Milport. Ochoco closed with right-in/right-out access at Moores. LRT on LPA alignment.	Hwy 224 overpass, full access intersection at Milport. Ochoco closed with right-in/right-out access at Moores. LRT on Tillamook alignment.	Ochoco overpass, with no access at 99E. Full access intersection at Milport. LRT on LPA alignment.	Ochoco overpass, with no access at 99E. Full access intersection at Milport. LRT on Tillamook alignment.
Evaluation Criteria										
Primary Criteria	Freight operations	□	□	■	■	■	■	■	■	■
	Traffic operations 99E throughput	■	■	■	■	■	■	■	□	□
	Traffic operations local access and crossing improvements	□	□	■	■	■	■	■	□	□
	Safety	■	■	■	■	■	■	■	■	■
	Resource limitations	■	■	■	■	■	□	□	■	■
	Out of direction travel for access to/from sub-areas	□	□	■	■	■	■	■	□	□
Secondary Criteria	Pedestrian connectivity	■	■	■	■	■	■	■	■	■
	Bicycle connectivity	■	■	■	■	■	■	■	■	■
	Transit access/egress and conflicts	■	■	■	■	■	■	■	■	■
	Robust solution	□	□	■	■	■	■	■	□	□

Overall Rating

■ ■ ■ ■ ■ ■ ■ ■ ■

Evaluation Scale

□ ■ ■ ■ ■

Poor Medium Good

Appendix E

Glossary of Technical Terms

Access Management: Measures regulating access to streets, roads, and highways from public roads and private driveways. Measures may include, but are not limited to: restrictions on the type and amount of access to roadways and use of physical controls (such as signals and channelization) to reduce impacts of approach traffic on the main facility.

Accessway: A facility that provides pedestrian and/or bicycle passage between streets, from a street to a building, or to other destinations such as schools, parks, or transit stops.

Average Daily Traffic (ADT): Measurement of the average number of vehicles passing a certain point each day on a highway, road, or street.

Alternative Modes: Transportation alternatives other than single-occupant automobiles. Alternative travel modes include travel by rail, transit, bicycle, and walking.

Arterial Street: High-volume, moderate-speed streets that carry vehicles within a city and between adjacent cities in surrounding metropolitan area. Arterials link major commercial, residential, industrial, and institutional areas. They are typically spaced about one mile apart to assure mobility and reduce the incidence of cut-through traffic on neighborhood routes and local streets.

Bicycle Facility: Any facility provided for the benefit of bicycle travel, including bikeways and parking facilities.

Bicycle Network: A system of connected bikeways that provide access to and from local and regional destinations.

Bike Lane: A portion of the roadway that has been designated by striping and pavement markings for the preferential or exclusive use of bicyclists.

Capacity: The maximum number of vehicles or individuals that can traverse a given segment of a transportation facility with prevailing roadway and traffic conditions.

Central Business District (CBD): Traditional downtown area. Usually characterized by slow traffic speeds, on-street parking, and a compact street grid system.

Collector Street: Moderate-volume, moderate-speed streets that provide access and circulation within and between residential neighborhoods, commercial areas, and industrial areas. They serve a citywide function of connectivity and are typically spaced about one-half mile apart. They distribute trips between a neighborhood street system and an arterial street system, linking a wide range of land uses.

Congestion Mitigation/Air Quality (CMAQ) Program: Jointly administered by the Federal Highway Administration (FHWA) and the Federal Transit Administration (FTA), was reauthorized in 2005 under the Safe, Accountable, Flexible, and Efficient Transportation Equity Act: A Legacy for Users (SAFETEA-LU). The SAFETEA-LU CMAQ program provides over \$8.6 billion in funds to state and transit agencies to invest in projects that reduce criteria air pollutants regulated from transportation-related sources.

Crosswalk: Portion of a roadway designated for pedestrian crossing. Can be either marked or unmarked. Unmarked crosswalks are the natural extension of the shoulder, curb line, or sidewalk at an intersection.

Demand Management: Actions that are designed to change travel behavior in order to improve performance of transportation facilities and to reduce need for additional road capacity. Methods may include subsidizing transit for the journey to work trip, charging for parking, starting a van or car pool system, or instituting flexible work hours.

Grade: A measure of the steepness of a roadway, bikeway, or walkway, usually expressed in a percentage form of the ratio between vertical rise to horizontal distance. A 5% grade, for example, means that the facility rises 5 feet in height over 100 feet in length.

Grade Separation: Vertical separation of one transportation facility from another at the point of intersection that prevents conflicts between modes and/or traffic moving at different speeds.

Impervious Surfaces: Hard surfaces that do not allow water to soak into the ground, increasing the amount of stormwater running into the drainage system.

Level of Service (LOS): A qualitative measure describing the perception of operation conditions within a traffic stream by motorists and/or passengers. An LOS rating of "A" to "F" describes the traffic flow on streets and at intersections, ranging from LOS A (representing virtually free flowing conditions) to LOS F (representing forced flow conditions and congestion).

Local Street: Low-volume, low-speed streets that emphasize access to adjacent land uses over mobility. Most local streets in a city are adjacent to residential uses and serve residential transportation needs; however, local streets can also serve industrial areas.

Metropolitan Planning Organization (MPO): An organization in each federally recognized urbanized area (population over 50,000) designated by the Governor, which has the responsibility for planning, programming, and coordinating the distribution of federal transportation resources.

Multimodal: A street or path designed for use by several modes of travel.

Multiuse Path: A path separated from motor vehicle traffic by an open space or barrier used by bicyclists, pedestrians, joggers, skaters, and other nonmotorized travelers.

National Highway System (NHS): Interconnected urban and rural principal arterial streets and highways that serve major population centers, ports, airports, and other major travel destinations and that meet national defense requirements and serve interstate and interregional travel.

Neighborhood Route: Moderate-volume, low-speed streets. They do not provide citywide circulation, as they mainly serve the immediate neighborhood in which they are located. They typically have residential frontage. Neighborhood routes are similar to local streets in design, but they are generally longer in length and have higher traffic volumes.

Peak Period or Peak Hour: The period of the day with the highest number of travelers. This is normally between 4-6 PM on weekdays.

Pedestrian Connection: A continuous, unobstructed, reasonably direct route between two points that is intended and suitable for pedestrian use. These connections could include sidewalks, walkways, accessways, stairways, and pedestrian bridges.

Pedestrian Facility: A facility that facilitates pedestrian travel, including walkways, crosswalks, signs, and signals.

Pedestrian Scale: Site and building design elements that are oriented and scaled to the pedestrian.

Regional Routes: High-volume, generally high-speed facilities. These routes may be used for travel within a city, but typically they are used for trips between cities, especially those that are separated by a significant distance.

Right-of-way (ROW): A general term denoting publicly owned land or property upon which public facilities and infrastructure is placed.

Shared Roadway: A type of bikeway where bicyclists and motor vehicles share a travel lane.

Sight Distance: The distance a person can see along an unobstructed line of sight.

Traffic Control Device: Sign, signal, or other fixture placed on or adjacent to a roadway that regulates, warns, or guides traffic. Can be either permanent or temporary.

Transportation Analysis Zone (TAZ): A geographic sub-area used to assess travel demands using a travel-demand forecasting model. Often defined by the transportation network and US Census blocks.

Transportation Disadvantaged: Individuals who have difficulty obtaining transportation because of their age, income, physical, or mental disability.

Transportation System Plan: A long-range plan that contains a city's long-term transportation goals and policies for pedestrians, cyclists, drivers, transit users, and freight carriers. It also provides for the coordination of transportation improvements at the local level and the integration of the local transportation system with the regional transportation system.

Urban Area: The area immediately surrounding an incorporated city or rural community that is urban in character, regardless of size.

Appendix F

Levels of Service (LOS) Descriptions

TRAFFIC LEVELS OF SERVICE

Analysis of traffic volumes is useful to understand the general nature of traffic in an area, but, by itself, does not indicate the ability of the street network to carry additional traffic or the quality of service afforded by specific facilities. To this end, the concept of level of service (LOS) was developed to subjectively describe street and/or intersection performance. Bottlenecks are most often found at intersections, and the ability of the street network to carry traffic efficiently is generally diminished in their vicinities. As a result, LOS is most often evaluated at intersections, but key corridors can be evaluated as well.

LOS categories are similar to report card ratings. Levels of Service A, B, and C indicate conditions where traffic moves without significant delays over periods of peak travel demand. Levels of service D, E, and F represent progressively worse peak hour operating conditions. Most urban communities set level of service D as the minimum acceptable level of service for peak hour operation and plan for level of service C or better for all other times of the day. The Highway Capacity Manual provides LOS calculation methodologies for both intersections and arterials.¹

¹ *Highway Capacity Manual 2000*, Transportation Research Board, Washington D.C., 2000, Chapters 16 and 17.

UNSIGNALIZED INTERSECTIONS

All-Way Stop Controlled

Level of service for all-way stop controlled intersection operations are reported for each intersection leg. This method calculates a delay value for each approach to the intersection.

The following table describes the amount of delay associated with each level of service for all-way stop controlled intersections.

Level of Service	Delay (seconds/vehicle)
A	0-10
B	>10-15
C	>15-25
D	>25-35
E	>35-50
F	>50

Source: Highway Capacity Manual 2000, Exhibit 17-22

Two-Way Stop Controlled

For two-way stop controlled intersections, level of service is reported for both major and minor streets. The LOS evaluation assesses available and critical gaps in the traffic stream, which are necessary for minor street traffic to be able to enter the major street traffic flow. It is not unusual for an intersection to experience level of service E or F conditions for the minor street left turn movement. However, poor level of service experienced by a few vehicles does not necessarily mean that the intersection as a whole is not operating within acceptable parameters.

The following table describes the amount of delay associated with each level of service for two-way stop controlled intersections.

Level of Service	Delay (seconds/vehicle)	Description
A	0-10	Little or no delay
B	>10-15	Short traffic delays
C	>15-25	Average traffic delays
D	>25-35	Long traffic delays
E	>35-50	Very long traffic delays
F	>50	Extreme delays potentially affecting other traffic movements in the intersection

Source: Highway Capacity Manual 2000, Exhibit 17-2

SIGNALIZED INTERSECTIONS

For signalized intersections, level of service is evaluated based upon average vehicle delay experienced by vehicles entering the intersection. Per the Highway Capacity Manual 2000, control delay (or signal delay) includes initial deceleration delay, queue move-up time, stopped delay, and final acceleration delay. As delay increases, the level of service decreases. Calculations for signalized and unsignalized intersections are different due to variations in traffic flow that are caused by different traffic control devices.

Level of Service	Delay (seconds/vehicle)	Description
A	0-10	Free Flow/Insignificant Delays: No approach phase is fully utilized by traffic and no vehicle waits longer than one red indication. Most vehicles do not stop at all. Progression is extremely favorable and most vehicles arrive during the green phase.
B	>10-20	Stable Operation/Minimal Delays: An occasional approach phase is fully utilized. Many drivers begin to feel somewhat restricted within platoons of vehicles. This level generally occurs with good progression, short cycle lengths, or both.
C	>20-35	Stable Operation/Acceptable Delays: Major approach phases fully utilized. Most drivers feel somewhat restricted. Higher delays may result from fair progression, longer cycle lengths, or both. Individual cycle failures may begin to appear at this level, and the number of vehicles stopping is significant.
D	>35-55	Approaching Unstable/Tolerable Delays: The influence of congestion becomes more noticeable. Drivers may have to wait through more than one red signal indication. Longer delays may result from some combination of unfavorable progression, long cycle lengths, or high v/c ratios. The proportion of vehicles not stopping declines, and individual cycle failures are noticeable.
E	>55-80	Unstable Operation/Significant Delays: Volumes at or near capacity. Vehicles may wait through several signal cycles. Long queues form upstream from intersection. These high delay values generally indicate poor progression, long cycle lengths, and high v/c ratios. Individual cycle failures are a frequent occurrence.
F	>80	Forced Flow/Excessive Delays: Represents jammed conditions. Queues may block upstream intersections. This level occurs when arrival flow rates exceed intersection capacity, and is considered to be unacceptable to most drivers. Poor progression, long cycle lengths, and v/c ratios approaching 1.0 may contribute to these high delay levels.

Source: Highway Capacity Manual 2000, Exhibit 16-2

Appendix G

Traffic Data

CONTENTS

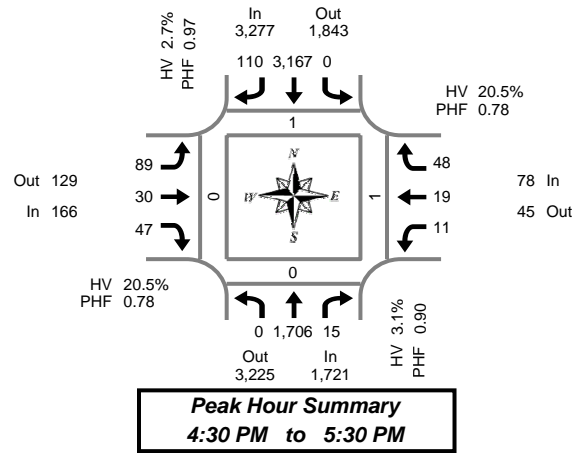
This appendix includes background and input data for the various traffic forecasting and analyses found throughout the TSP. See below for the location of the data for each type of analysis.

Peak Hour Turn Movement and 24-Hour Tube Counts	G-2
Existing Conditions Synchro Analysis	G-98
Future Conditions Synchro Analysis.....	G-122
Signal Warrant Worksheet	G-145
Crash Data.....	G-146
Project Cost Estimates.....	G-166

Total Vehicle Summary



Clay Carney
(503) 833-2740



Hwy 99E & SE Ochoco St

Wednesday, November 29, 2006
3:00 PM to 6:00 PM

15-Minute Interval Summary

3:00 PM to 6:00 PM

Interval Start Time	Northbound Hwy 99E				Southbound Hwy 99E				Eastbound SE Ochoco St				Westbound SE Ochoco St				Interval Total	Pedestrians Crosswalk			
	L	T	R	Bikes	L	T	R	Bikes	L	T	R	Bikes	L	T	R	Bikes		North	South	East	West
3:00 PM	0	350	12	0	0	537	44	0	21	8	13	0	6	6	13	0	1,010	0	0	0	0
3:15 PM	0	334	5	0	0	642	36	0	18	6	8	0	5	5	10	0	1,069	0	0	0	0
3:30 PM	0	389	7	0	0	691	45	0	32	9	18	0	8	2	32	0	1,233	1	0	0	0
3:45 PM	0	393	3	0	0	779	39	0	16	8	5	0	6	2	12	0	1,263	0	1	1	0
4:00 PM	0	393	4	0	0	760	46	0	25	7	18	0	16	5	20	0	1,294	0	0	0	0
4:15 PM	0	378	8	0	0	805	30	0	18	5	6	0	5	4	12	0	1,271	0	0	1	2
4:30 PM	0	407	7	0	0	792	37	0	24	11	18	0	4	8	10	0	1,318	0	0	0	0
4:45 PM	0	432	6	0	0	767	33	0	18	7	9	0	2	4	6	0	1,284	0	0	0	0
5:00 PM	0	474	2	0	0	790	15	0	26	8	14	0	4	4	17	0	1,354	0	0	0	0
5:15 PM	0	393	0	0	0	818	25	0	21	4	6	0	1	3	15	0	1,286	1	0	1	0
5:30 PM	0	349	3	0	0	683	22	0	14	6	13	0	5	2	10	0	1,107	0	0	0	0
5:45 PM	0	353	4	0	0	690	28	0	9	5	3	0	3	4	4	0	1,103	0	0	0	1
Total Survey	0	4,645	61	0	0	8,754	400	0	242	84	131	0	65	49	161	0	14,592	2	1	3	3

Peak Hour Summary

4:30 PM to 5:30 PM

By Approach	Northbound Hwy 99E				Southbound Hwy 99E				Eastbound SE Ochoco St				Westbound SE Ochoco St				Total	Pedestrians Crosswalk			
	In	Out	Total	Bikes	In	Out	Total	Bikes	In	Out	Total	Bikes	In	Out	Total	Bikes		North	South	East	West
Volume	1,721	3,225	4,946	0	3,277	1,843	5,120	0	166	129	295	0	78	45	123	0	5,242	1	0	1	0
%HV	3.1%				2.7%				20.5%				20.5%				3.6%				
PHF	0.90				0.97				0.78				0.78				0.97				

By Movement	Northbound Hwy 99E				Southbound Hwy 99E				Eastbound SE Ochoco St				Westbound SE Ochoco St				Total
	L	T	R	Total	L	T	R	Total	L	T	R	Total	L	T	R	Total	
Volume	0	1,706	15	1,721	0	3,167	110	3,277	89	30	47	166	11	19	48	78	5,242
%HV	0.0%	2.8%	33.3%	3.1%	0.0%	1.8%	27.3%	2.7%	10.1%	66.7%	10.6%	20.5%	36.4%	5.3%	22.9%	20.5%	3.6%
PHF	0.00	0.90	0.54	0.90	0.00	0.97	0.74	0.97	0.86	0.68	0.65	0.78	0.69	0.59	0.71	0.78	0.97

Rolling Hour Summary

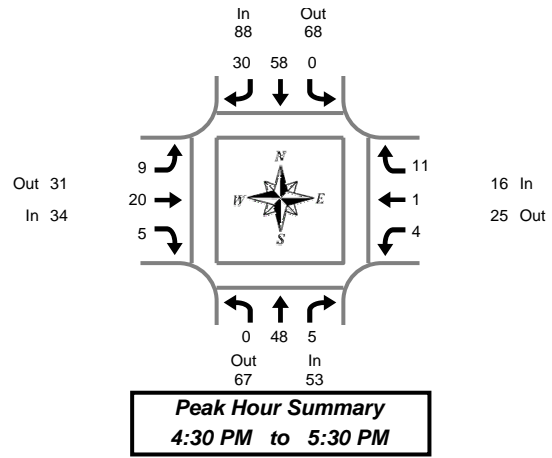
3:00 PM to 6:00 PM

Interval Start Time	Northbound Hwy 99E				Southbound Hwy 99E				Eastbound SE Ochoco St				Westbound SE Ochoco St				Interval Total	Pedestrians Crosswalk			
	L	T	R	Bikes	L	T	R	Bikes	L	T	R	Bikes	L	T	R	Bikes		North	South	East	West
3:00 PM	0	1,466	27	0	0	2,649	164	0	87	31	44	0	25	15	67	0	4,575	1	1	1	0
3:15 PM	0	1,509	19	0	0	2,872	166	0	91	30	49	0	35	14	74	0	4,859	1	1	1	0
3:30 PM	0	1,553	22	0	0	3,035	160	0	91	29	47	0	35	13	76	0	5,061	1	1	2	2
3:45 PM	0	1,571	22	0	0	3,136	152	0	83	31	47	0	31	19	54	0	5,146	0	1	2	2
4:00 PM	0	1,610	25	0	0	3,124	146	0	85	30	51	0	27	21	48	0	5,167	0	0	1	2
4:15 PM	0	1,691	23	0	0	3,154	115	0	86	31	47	0	15	20	45	0	5,227	0	0	1	2
4:30 PM	0	1,706	15	0	0	3,167	110	0	89	30	47	0	11	19	48	0	5,242	1	0	1	0
4:45 PM	0	1,648	11	0	0	3,058	95	0	79	25	42	0	12	13	48	0	5,031	1	0	1	0
5:00 PM	0	1,569	9	0	0	2,981	90	0	70	23	36	0	13	13	46	0	4,850	1	0	1	1

Heavy Vehicle Summary



Clay Carney
(503) 833-2740



Hwy 99E & SE Ochoco St

Wednesday, November 29, 2006
3:00 PM to 6:00 PM

Heavy Vehicle 15-Minute Interval Summary 3:00 PM to 6:00 PM

Interval Start Time	Northbound Hwy 99E				Southbound Hwy 99E				Eastbound SE Ochoco St				Westbound SE Ochoco St				Interval Total
	L	T	R	Total	L	T	R	Total	L	T	R	Total	L	T	R	Total	
3:00 PM	0	18	5	23	0	21	10	31	1	5	0	6	2	2	3	7	67
3:15 PM	0	19	1	20	0	19	8	27	0	2	3	5	1	2	3	6	58
3:30 PM	0	16	5	21	0	29	9	38	5	3	0	8	1	0	5	6	73
3:45 PM	0	18	0	18	0	37	8	45	1	2	1	4	1	1	2	4	71
4:00 PM	0	18	2	20	0	23	12	35	1	2	0	3	3	1	6	10	68
4:15 PM	0	23	2	25	0	18	3	21	3	3	0	6	0	1	4	5	57
4:30 PM	0	13	2	15	0	16	11	27	4	8	0	12	2	1	2	5	59
4:45 PM	0	10	2	12	0	20	7	27	3	4	2	9	1	0	3	4	52
5:00 PM	0	18	1	19	0	11	5	16	0	5	3	8	1	0	3	4	47
5:15 PM	0	7	0	7	0	11	7	18	2	3	0	5	0	0	3	3	33
5:30 PM	0	5	0	5	0	13	7	20	0	6	0	6	0	1	3	4	35
5:45 PM	0	17	1	18	0	13	8	21	1	4	1	6	0	1	1	2	47
Total Survey	0	182	21	203	0	231	95	326	21	47	10	78	12	10	38	60	667

Heavy Vehicle Peak Hour Summary 4:30 PM to 5:30 PM

By Approach	Northbound Hwy 99E			Southbound Hwy 99E			Eastbound SE Ochoco St			Westbound SE Ochoco St			Total
	In	Out	Total	In	Out	Total	In	Out	Total	In	Out	Total	
Volume	53	67	120	88	68	156	34	31	65	16	25	41	191
PHF	0.21			0.19			0.29			0.20			0.23

By Movement	Northbound Hwy 99E				Southbound Hwy 99E				Eastbound SE Ochoco St				Westbound SE Ochoco St				Total
	L	T	R	Total	L	T	R	Total	L	T	R	Total	L	T	R	Total	
Volume	0	48	5	53	0	58	30	88	9	20	5	34	4	1	11	16	191
PHF	0.00	0.20	0.11	0.21	0.00	0.16	0.26	0.19	0.23	0.29	0.25	0.29	0.20	0.06	0.21	0.20	0.23

Heavy Vehicle Rolling Hour Summary 3:00 PM to 6:00 PM

Interval Start Time	Northbound Hwy 99E				Southbound Hwy 99E				Eastbound SE Ochoco St				Westbound SE Ochoco St				Interval Total
	L	T	R	Total	L	T	R	Total	L	T	R	Total	L	T	R	Total	
3:00 PM	0	71	11	82	0	106	35	141	7	12	4	23	5	5	13	23	269
3:15 PM	0	71	8	79	0	108	37	145	7	9	4	20	6	4	16	26	270
3:30 PM	0	75	9	84	0	107	32	139	10	10	1	21	5	3	17	25	269
3:45 PM	0	72	6	78	0	94	34	128	9	15	1	25	6	4	14	24	255
4:00 PM	0	64	8	72	0	77	33	110	11	17	2	30	6	3	15	24	236
4:15 PM	0	64	7	71	0	65	26	91	10	20	5	35	4	2	12	18	215
4:30 PM	0	48	5	53	0	58	30	88	9	20	5	34	4	1	11	16	191
4:45 PM	0	40	3	43	0	55	26	81	5	18	5	28	2	1	12	15	167
5:00 PM	0	47	2	49	0	48	27	75	3	18	4	25	1	2	10	13	162

Peak Hour Summary

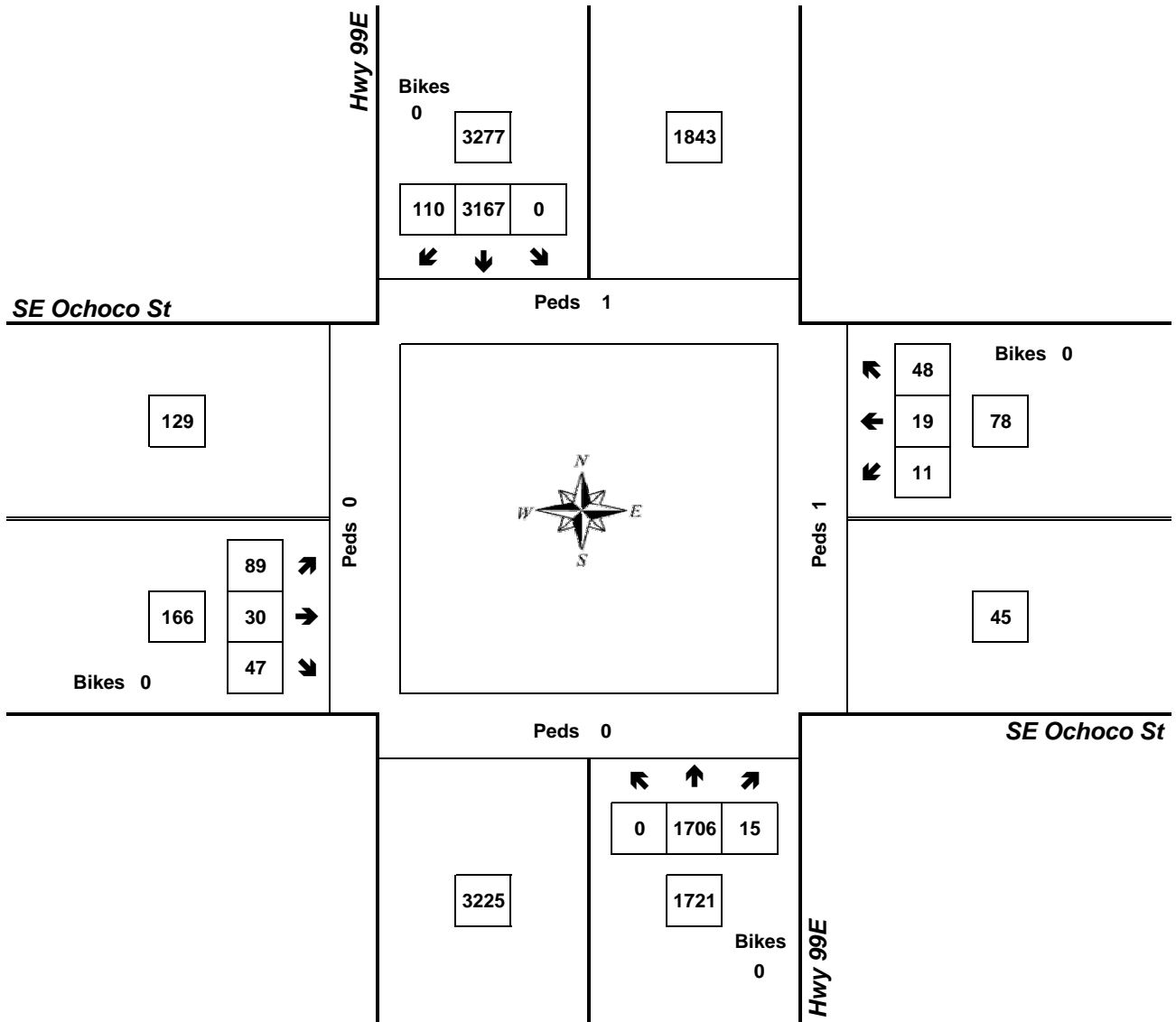


Clay Carney
(503) 833-2740

Hwy 99E & SE Ochoco St

4:30 PM to 5:30 PM

Wednesday, November 29, 2006



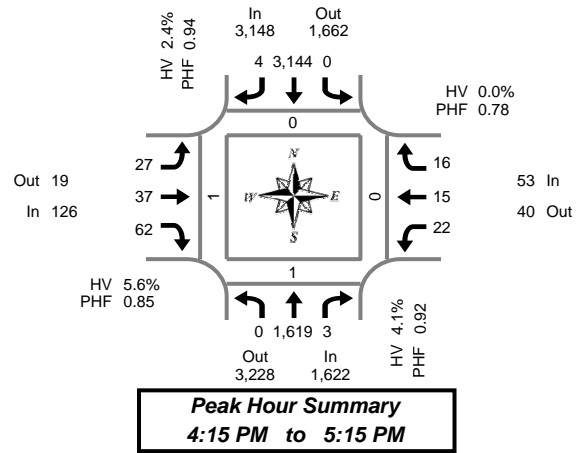
Approach	PHF	HV%	Volume
EB	0.78	20.5%	166
WB	0.78	20.5%	78
NB	0.90	3.1%	1,721
SB	0.97	2.7%	3,277
Intersection	0.97	3.6%	5,242

Count Period: 3:00 PM to 6:00 PM

Total Vehicle Summary



Clay Carney
(503) 833-2740



Hwy 99E & SE Milport Rd

Wednesday, November 29, 2006
3:00 PM to 6:00 PM

15-Minute Interval Summary 3:00 PM to 6:00 PM

Interval Start Time	Northbound Hwy 99E				Southbound Hwy 99E				Eastbound SE Milport Rd				Westbound SE Milport Rd				Interval Total	Pedestrians Crosswalk			
	L	T	R	Bikes	L	T	R	Bikes	L	T	R	Bikes	L	T	R	Bikes		North	South	East	West
3:00 PM	0	323	0	0	0	599	1	0	8	8	11	0	12	5	9	0	976	0	0	0	0
3:15 PM	0	370	0	0	0	621	0	0	4	14	11	0	8	5	7	0	1,040	0	0	0	0
3:30 PM	0	329	1	0	0	761	1	0	6	7	10	0	15	9	8	0	1,147	1	1	0	0
3:45 PM	0	387	0	0	0	795	1	0	2	11	7	0	3	4	3	0	1,213	1	0	0	0
4:00 PM	0	349	0	0	0	813	1	0	9	11	17	0	10	5	5	0	1,220	0	0	0	2
4:15 PM	0	402	2	0	0	776	0	0	4	11	11	0	5	7	5	0	1,223	0	1	0	0
4:30 PM	0	339	1	0	0	835	1	0	8	9	16	0	9	2	3	0	1,223	0	0	0	0
4:45 PM	0	442	0	0	0	734	3	0	7	14	9	0	3	5	3	0	1,220	0	0	0	0
5:00 PM	0	436	0	0	0	799	0	0	8	3	26	0	5	1	5	0	1,283	0	0	0	1
5:15 PM	0	390	3	0	0	737	1	0	7	7	22	0	8	1	2	0	1,178	0	0	0	2
5:30 PM	0	349	0	0	0	747	1	0	3	7	12	0	5	3	2	0	1,129	0	0	0	1
5:45 PM	0	368	1	0	0	635	1	0	4	10	6	0	1	5	2	0	1,033	0	0	0	0
Total Survey	0	4,484	8	0	0	8,852	11	0	70	112	158	0	84	52	54	0	13,885	2	2	0	6

Peak Hour Summary 4:15 PM to 5:15 PM

By Approach	Northbound Hwy 99E				Southbound Hwy 99E				Eastbound SE Milport Rd				Westbound SE Milport Rd				Total	Pedestrians Crosswalk			
	In	Out	Total	Bikes	In	Out	Total	Bikes	In	Out	Total	Bikes	In	Out	Total	Bikes		North	South	East	West
Volume	1,622	3,228	4,850	0	3,148	1,662	4,810	0	126	19	145	0	53	40	93	0	4,949	0	1	0	1
%HV	4.1%				2.4%				5.6%				0.0%				3.0%				
PHF	0.92				0.94				0.85				0.78				0.96				

By Movement	Northbound Hwy 99E				Southbound Hwy 99E				Eastbound SE Milport Rd				Westbound SE Milport Rd				Total
	L	T	R	Total	L	T	R	Total	L	T	R	Total	L	T	R	Total	
Volume	0	1,619	3	1,622	0	3,144	4	3,148	27	37	62	126	22	15	16	53	4,949
%HV	0.0%	4.1%	0.0%	4.1%	0.0%	2.3%	75.0%	2.4%	11.1%	8.1%	1.6%	5.6%	0.0%	0.0%	0.0%	0.0%	3.0%
PHF	0.00	0.92	0.38	0.92	0.00	0.94	0.33	0.94	0.84	0.66	0.60	0.85	0.61	0.54	0.80	0.78	0.96

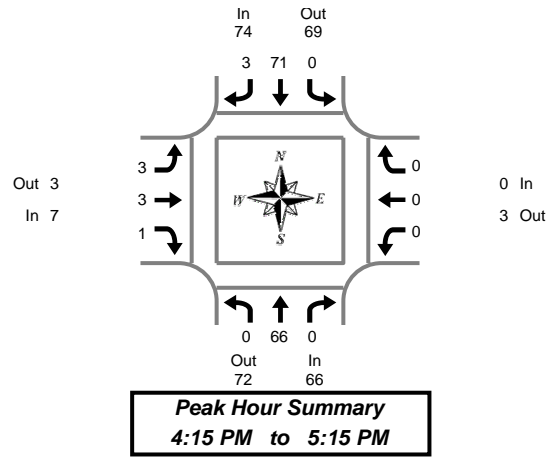
Rolling Hour Summary 3:00 PM to 6:00 PM

Interval Start Time	Northbound Hwy 99E				Southbound Hwy 99E				Eastbound SE Milport Rd				Westbound SE Milport Rd				Interval Total	Pedestrians Crosswalk			
	L	T	R	Bikes	L	T	R	Bikes	L	T	R	Bikes	L	T	R	Bikes		North	South	East	West
3:00 PM	0	1,409	1	0	0	2,776	3	0	20	40	39	0	38	23	27	0	4,376	2	1	0	0
3:15 PM	0	1,435	1	0	0	2,990	3	0	21	43	45	0	36	23	23	0	4,620	2	1	0	2
3:30 PM	0	1,467	3	0	0	3,145	3	0	21	40	45	0	33	25	21	0	4,803	2	2	0	2
3:45 PM	0	1,477	3	0	0	3,219	3	0	23	42	51	0	27	18	16	0	4,879	1	1	0	2
4:00 PM	0	1,532	3	0	0	3,158	5	0	28	45	53	0	27	19	16	0	4,886	0	1	0	2
4:15 PM	0	1,619	3	0	0	3,144	4	0	27	37	62	0	22	15	16	0	4,949	0	1	0	1
4:30 PM	0	1,607	4	0	0	3,105	5	0	30	33	73	0	25	9	13	0	4,904	0	0	0	3
4:45 PM	0	1,617	3	0	0	3,017	5	0	25	31	69	0	21	10	12	0	4,810	0	0	0	4
5:00 PM	0	1,543	4	0	0	2,918	3	0	22	27	66	0	19	10	11	0	4,623	0	0	0	4

Heavy Vehicle Summary



Clay Carney
(503) 833-2740



Hwy 99E & SE Milport Rd

Wednesday, November 29, 2006
3:00 PM to 6:00 PM

Heavy Vehicle 15-Minute Interval Summary 3:00 PM to 6:00 PM

Interval Start Time	Northbound Hwy 99E				Southbound Hwy 99E				Eastbound SE Milport Rd				Westbound SE Milport Rd				Interval Total	
	L	T	R	Total	L	T	R	Total	L	T	R	Total	L	T	R	Total		
3:00 PM	0	22	0	22	0	23	0	23	0	0	1	1	3	1	0	0	4	50
3:15 PM	0	19	0	19	0	23	0	23	1	1	0	2	1	0	0	1	4	45
3:30 PM	0	18	0	18	0	31	0	31	3	0	1	4	0	0	0	0	5	53
3:45 PM	0	18	0	18	0	39	0	39	0	1	1	2	0	0	0	0	3	59
4:00 PM	0	19	0	19	0	27	0	27	1	1	0	2	0	0	0	0	3	48
4:15 PM	0	24	0	24	0	18	0	18	1	2	1	4	0	0	0	0	4	46
4:30 PM	0	12	0	12	0	18	1	19	1	0	0	1	0	0	0	0	2	32
4:45 PM	0	12	0	12	0	21	2	23	0	0	0	0	0	0	0	0	0	35
5:00 PM	0	18	0	18	0	14	0	14	1	1	0	2	0	0	0	0	3	34
5:15 PM	0	7	0	7	0	10	1	11	0	0	0	0	1	0	0	1	2	19
5:30 PM	0	5	0	5	0	13	0	13	0	0	0	0	0	0	0	0	0	18
5:45 PM	0	17	0	17	0	14	0	14	1	0	0	1	0	0	0	0	2	32
Total Survey	0	191	0	191	0	251	4	255	9	6	4	19	5	1	0	6	47	471

Heavy Vehicle Peak Hour Summary 4:15 PM to 5:15 PM

By Approach	Northbound Hwy 99E			Southbound Hwy 99E			Eastbound SE Milport Rd			Westbound SE Milport Rd			Total
	In	Out	Total	In	Out	Total	In	Out	Total	In	Out	Total	
Volume	66	72	138	74	69	143	7	3	10	0	3	3	147
PHF	0.27			0.19			0.22			0.00			0.23

By Movement	Northbound Hwy 99E				Southbound Hwy 99E				Eastbound SE Milport Rd				Westbound SE Milport Rd				Total
	L	T	R	Total	L	T	R	Total	L	T	R	Total	L	T	R	Total	
Volume	0	66	0	66	0	71	3	74	3	3	1	7	0	0	0	0	147
PHF	0.00	0.27	0.00	0.27	0.00	0.18	0.25	0.19	0.19	0.19	0.13	0.22	0.00	0.00	0.00	0.00	0.23

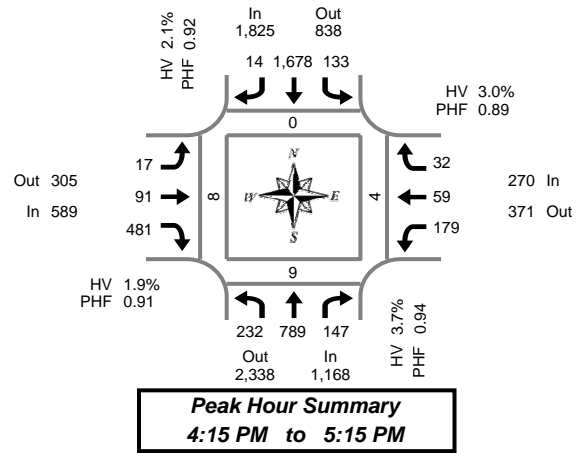
Heavy Vehicle Rolling Hour Summary 3:00 PM to 6:00 PM

Interval Start Time	Northbound Hwy 99E				Southbound Hwy 99E				Eastbound SE Milport Rd				Westbound SE Milport Rd				Interval Total
	L	T	R	Total	L	T	R	Total	L	T	R	Total	L	T	R	Total	
3:00 PM	0	77	0	77	0	116	0	116	4	2	3	9	4	1	0	5	207
3:15 PM	0	74	0	74	0	120	0	120	5	3	2	10	1	0	0	1	205
3:30 PM	0	79	0	79	0	115	0	115	5	4	3	12	0	0	0	0	206
3:45 PM	0	73	0	73	0	102	1	103	3	4	2	9	0	0	0	0	185
4:00 PM	0	67	0	67	0	84	3	87	3	3	1	7	0	0	0	0	161
4:15 PM	0	66	0	66	0	71	3	74	3	3	1	7	0	0	0	0	147
4:30 PM	0	49	0	49	0	63	4	67	2	1	0	3	1	0	0	1	120
4:45 PM	0	42	0	42	0	58	3	61	1	1	0	2	1	0	0	1	106
5:00 PM	0	47	0	47	0	51	1	52	2	1	0	3	1	0	0	1	103

Total Vehicle Summary



Clay Carney
(503) 833-2740



Hwy 99E & SE Harrison St

Wednesday, November 29, 2006
3:00 PM to 6:00 PM

15-Minute Interval Summary 3:00 PM to 6:00 PM

Interval Start Time	Northbound Hwy 99E				Southbound Hwy 99E				Eastbound SE Harrison St				Westbound SE Harrison St				Interval Total	Pedestrians Crosswalk			
	L	T	R	Bikes	L	T	R	Bikes	L	T	R	Bikes	L	T	R	Bikes		North	South	East	West
3:00 PM	63	164	41	0	34	266	2	0	8	19	90	0	40	10	14	0	751	0	1	0	4
3:15 PM	53	188	28	0	45	359	6	0	0	12	67	0	27	14	15	0	814	0	0	0	1
3:30 PM	59	183	43	0	31	358	1	0	7	15	103	0	44	9	18	0	871	0	2	1	1
3:45 PM	50	188	39	0	30	423	7	0	3	23	83	0	44	9	16	0	915	0	1	0	7
4:00 PM	57	190	40	0	39	390	5	0	9	13	131	0	54	15	9	0	952	0	2	0	2
4:15 PM	57	186	31	0	43	446	3	0	3	16	113	0	44	13	8	0	963	0	4	1	2
4:30 PM	64	174	49	0	36	367	5	0	4	26	132	1	41	16	7	0	921	0	3	3	1
4:45 PM	57	206	35	0	33	461	0	0	5	24	114	0	41	15	9	0	1,000	0	0	0	1
5:00 PM	54	223	32	0	21	404	6	0	5	25	122	0	53	15	8	0	968	0	2	0	4
5:15 PM	58	168	38	0	51	438	2	0	4	23	98	0	39	15	10	0	944	0	1	0	0
5:30 PM	54	168	30	0	24	403	1	0	3	18	111	0	45	14	16	0	887	0	0	0	4
5:45 PM	47	164	30	0	22	404	2	0	3	17	92	0	37	14	8	0	840	0	0	0	1
Total Survey	673	2,202	436	0	409	4,719	40	0	54	231	1,256	1	509	159	138	0	10,826	0	16	5	28

Peak Hour Summary 4:15 PM to 5:15 PM

By Approach	Northbound Hwy 99E				Southbound Hwy 99E				Eastbound SE Harrison St				Westbound SE Harrison St				Total	Pedestrians Crosswalk			
	In	Out	Total	Bikes	In	Out	Total	Bikes	In	Out	Total	Bikes	In	Out	Total	Bikes		North	South	East	West
Volume	1,168	2,338	3,506	0	1,825	838	2,663	0	589	305	894	1	270	371	641	0	3,852	0	9	4	8
%HV	3.7%				2.1%				1.9%				3.0%				2.6%				
PHF	0.94				0.92				0.91				0.89				0.96				

By Movement	Northbound Hwy 99E				Southbound Hwy 99E				Eastbound SE Harrison St				Westbound SE Harrison St				Total
	L	T	R	Total	L	T	R	Total	L	T	R	Total	L	T	R	Total	
Volume	232	789	147	1,168	133	1,678	14	1,825	17	91	481	589	179	59	32	270	3,852
%HV	1.7%	4.6%	2.0%	3.7%	3.0%	2.0%	0.0%	2.1%	5.9%	6.6%	0.8%	1.9%	1.7%	6.8%	3.1%	3.0%	2.6%
PHF	0.91	0.88	0.75	0.94	0.77	0.91	0.58	0.92	0.85	0.88	0.91	0.91	0.84	0.92	0.89	0.89	0.96

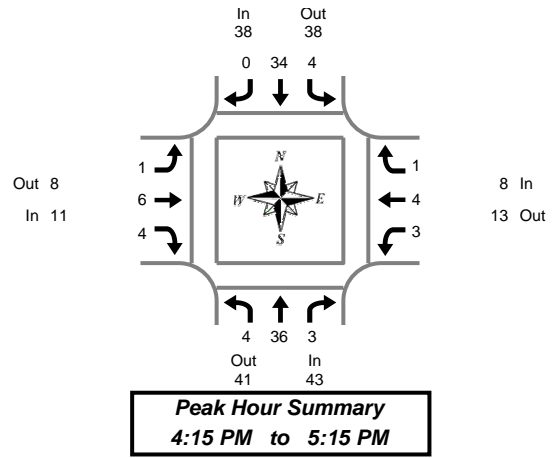
Rolling Hour Summary 3:00 PM to 6:00 PM

Interval Start Time	Northbound Hwy 99E				Southbound Hwy 99E				Eastbound SE Harrison St				Westbound SE Harrison St				Interval Total	Pedestrians Crosswalk			
	L	T	R	Bikes	L	T	R	Bikes	L	T	R	Bikes	L	T	R	Bikes		North	South	East	West
3:00 PM	225	723	151	0	140	1,406	16	0	18	69	343	0	155	42	63	0	3,351	0	4	1	13
3:15 PM	219	749	150	0	145	1,530	19	0	19	63	384	0	169	47	58	0	3,552	0	5	1	11
3:30 PM	223	747	153	0	143	1,617	16	0	22	67	430	0	186	46	51	0	3,701	0	9	2	12
3:45 PM	228	738	159	0	148	1,626	20	0	19	78	459	1	183	53	40	0	3,751	0	10	4	12
4:00 PM	235	756	155	0	151	1,664	13	0	21	79	490	1	180	59	33	0	3,836	0	9	4	6
4:15 PM	232	789	147	0	133	1,678	14	0	17	91	481	1	179	59	32	0	3,852	0	9	4	8
4:30 PM	233	771	154	0	141	1,670	13	0	18	98	466	1	174	61	34	0	3,833	0	6	3	6
4:45 PM	223	765	135	0	129	1,706	9	0	17	90	445	0	178	59	43	0	3,799	0	3	0	9
5:00 PM	213	723	130	0	118	1,649	11	0	15	83	423	0	174	58	42	0	3,639	0	3	0	9

Heavy Vehicle Summary



Clay Carney
(503) 833-2740



Hwy 99E & SE Harrison St

Wednesday, November 29, 2006
3:00 PM to 6:00 PM

Heavy Vehicle 15-Minute Interval Summary 3:00 PM to 6:00 PM

Interval Start Time	Northbound Hwy 99E				Southbound Hwy 99E				Eastbound SE Harrison St				Westbound SE Harrison St				Interval Total
	L	T	R	Total	L	T	R	Total	L	T	R	Total	L	T	R	Total	
3:00 PM	1	5	1	7	0	12	1	13	1	1	2	4	2	1	1	4	28
3:15 PM	0	8	0	8	0	14	0	14	0	1	3	4	1	1	1	3	29
3:30 PM	0	10	1	11	0	14	0	14	0	2	1	3	0	1	0	1	29
3:45 PM	2	10	3	15	1	15	0	16	0	2	3	5	3	1	1	5	41
4:00 PM	2	14	1	17	4	10	1	15	0	2	6	8	3	1	0	4	44
4:15 PM	2	9	1	12	2	11	0	13	0	2	1	3	0	1	1	2	30
4:30 PM	2	10	1	13	0	7	0	7	1	1	2	4	2	1	0	3	27
4:45 PM	0	8	0	8	2	7	0	9	0	1	1	2	0	1	0	1	20
5:00 PM	0	9	1	10	0	9	0	9	0	2	0	2	1	1	0	2	23
5:15 PM	2	2	1	5	1	6	0	7	0	1	1	2	0	1	0	1	15
5:30 PM	0	3	0	3	0	8	0	8	0	0	0	0	0	1	0	1	12
5:45 PM	1	4	2	7	0	2	1	3	0	1	1	2	1	1	0	2	14
Total Survey	12	92	12	116	10	115	3	128	2	16	21	39	13	12	4	29	312

Heavy Vehicle Peak Hour Summary 4:15 PM to 5:15 PM

By Approach	Northbound Hwy 99E			Southbound Hwy 99E			Eastbound SE Harrison St			Westbound SE Harrison St			Total
	In	Out	Total	In	Out	Total	In	Out	Total	In	Out	Total	
Volume	43	41	84	38	38	76	11	8	19	8	13	21	100
PHF	0.24			0.21			0.17			0.18			0.22

By Movement	Northbound Hwy 99E				Southbound Hwy 99E				Eastbound SE Harrison St				Westbound SE Harrison St				Total
	L	T	R	Total	L	T	R	Total	L	T	R	Total	L	T	R	Total	
Volume	4	36	3	43	4	34	0	38	1	6	4	11	3	4	1	8	100
PHF	0.17	0.26	0.15	0.24	0.14	0.20	0.00	0.21	0.25	0.25	0.10	0.17	0.13	0.33	0.13	0.18	0.22

Heavy Vehicle Rolling Hour Summary 3:00 PM to 6:00 PM

Interval Start Time	Northbound Hwy 99E				Southbound Hwy 99E				Eastbound SE Harrison St				Westbound SE Harrison St				Interval Total
	L	T	R	Total	L	T	R	Total	L	T	R	Total	L	T	R	Total	
3:00 PM	3	33	5	41	1	55	1	57	1	6	9	16	6	4	3	13	127
3:15 PM	4	42	5	51	5	53	1	59	0	7	13	20	7	4	2	13	143
3:30 PM	6	43	6	55	7	50	1	58	0	8	11	19	6	4	2	12	144
3:45 PM	8	43	6	57	7	43	1	51	1	7	12	20	8	4	2	14	142
4:00 PM	6	41	3	50	8	35	1	44	1	6	10	17	5	4	1	10	121
4:15 PM	4	36	3	43	4	34	0	38	1	6	4	11	3	4	1	8	100
4:30 PM	4	29	3	36	3	29	0	32	1	5	4	10	3	4	0	7	85
4:45 PM	2	22	2	26	3	30	0	33	0	4	2	6	1	4	0	5	70
5:00 PM	3	18	4	25	1	25	1	27	0	4	2	6	2	4	0	6	64

Peak Hour Summary

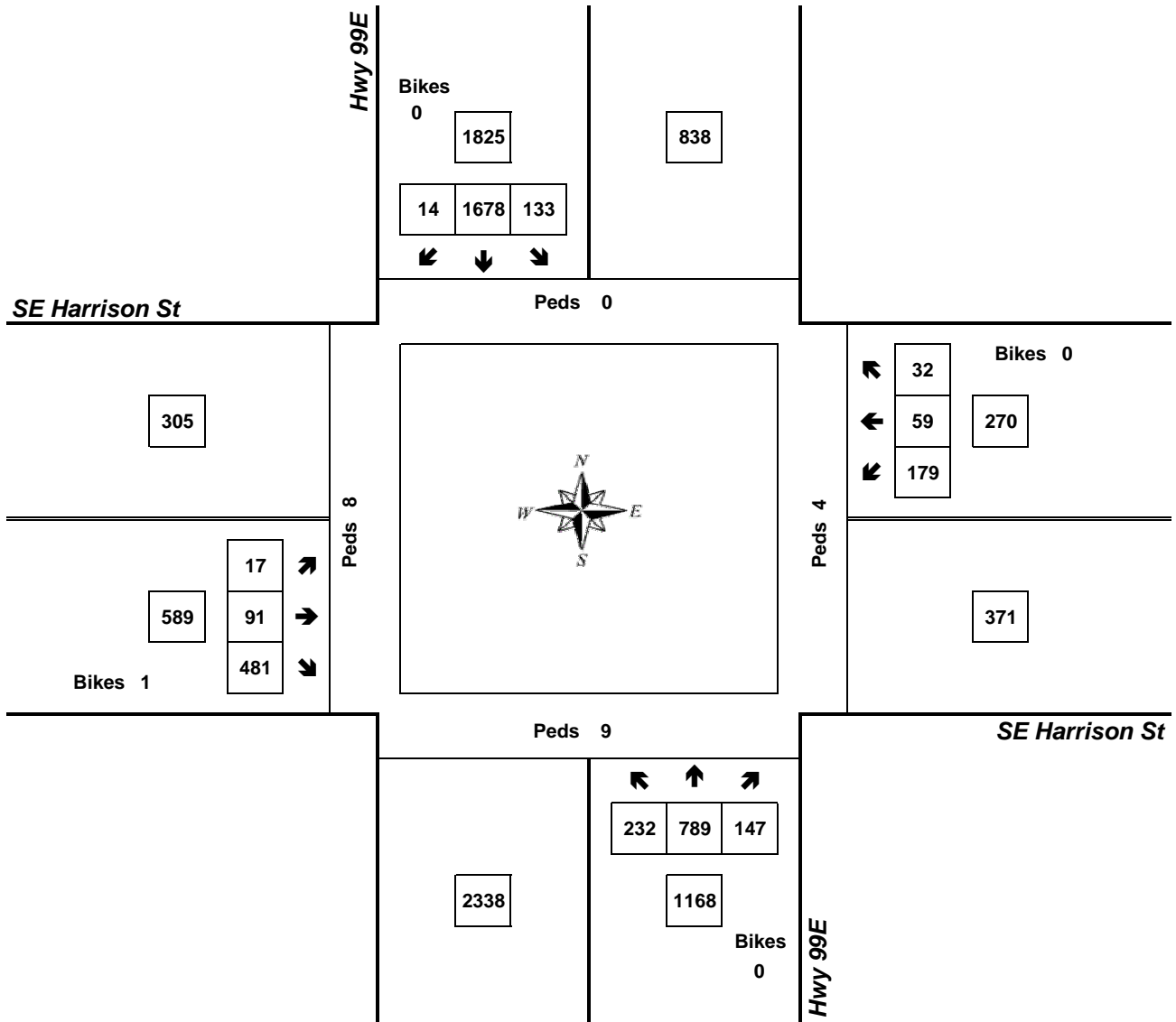


Clay Carney
(503) 833-2740

Hwy 99E & SE Harrison St

4:15 PM to 5:15 PM

Wednesday, November 29, 2006



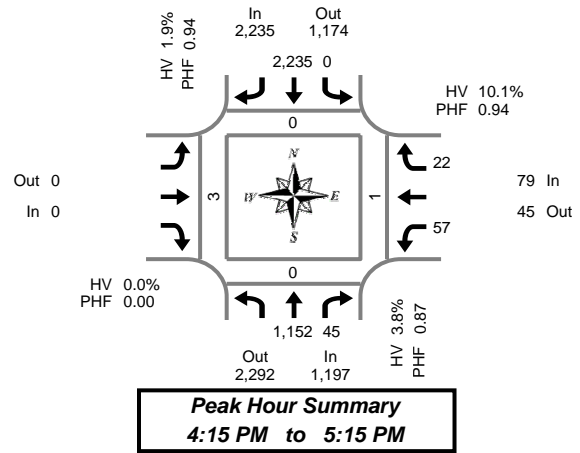
Approach	PHF	HV%	Volume
EB	0.91	1.9%	589
WB	0.89	3.0%	270
NB	0.94	3.7%	1,168
SB	0.92	2.1%	1,825
Intersection	0.96	2.6%	3,852

Count Period: 3:00 PM to 6:00 PM

Total Vehicle Summary



Clay Carney
(503) 833-2740



Hwy 99E & SE Monroe St

Wednesday, November 29, 2006
3:00 PM to 6:00 PM

15-Minute Interval Summary 3:00 PM to 6:00 PM

Interval Start Time	Northbound Hwy 99E			Southbound Hwy 99E			Eastbound SE Monroe St			Westbound SE Monroe St			Interval Total	Pedestrians Crosswalk			
	T	R	Bikes	L	T	Bikes			Bikes	L	R	Bikes		North	South	East	West
3:00 PM	280	16	0	0	415	0			0	14	0	0	739	0	3	0	0
3:15 PM	240	14	0	0	434	0			0	17	0	0	715	0	0	0	0
3:30 PM	298	13	0	0	520	0			0	7	0	0	851	0	0	1	1
3:45 PM	226	5	0	0	536	0			0	12	0	0	793	0	0	0	0
4:00 PM	296	13	0	0	583	0			0	10	0	0	906	0	0	0	0
4:15 PM	276	10	0	0	591	1			0	13	0	0	895	0	0	0	0
4:30 PM	289	5	0	0	540	0			0	16	0	0	854	0	0	0	0
4:45 PM	263	11	1	0	512	0			0	10	0	0	806	0	0	1	3
5:00 PM	324	19	0	0	592	0			0	18	0	0	956	0	0	0	0
5:15 PM	242	14	0	0	544	0			0	19	0	0	827	0	0	0	0
5:30 PM	254	12	0	0	558	0			0	12	0	0	843	0	0	0	0
5:45 PM	234	8	0	0	543	0			0	13	0	0	805	0	0	0	0
Total Survey	3,222	140	1	0	6,368	1			0	161	0	0	9,990	0	3	2	4

Peak Hour Summary 4:15 PM to 5:15 PM

By Approach	Northbound Hwy 99E				Southbound Hwy 99E				Eastbound SE Monroe St				Westbound SE Monroe St				Total	Pedestrians Crosswalk			
	In	Out	Total	Bikes	In	Out	Total	Bikes	In	Out	Total	Bikes	In	Out	Total	Bikes		North	South	East	West
Volume	1,197	2,292	3,489	1	2,235	1,174	3,409	1	0	0	0	0	79	45	124	0	3,511	0	0	1	3
%HV	3.8%				1.9%				0.0%				10.1%				2.7%				
PHF	0.87				0.94				0.00				0.94				0.92				

By Movement	Northbound Hwy 99E			Southbound Hwy 99E			Eastbound SE Monroe St			Westbound SE Monroe St			Total				
	T	R	Total	L	T	Total			Total	L	R	Total					
Volume	1,152	45	1,197	0	2,235	2,235			0	57	22	79	3,511				
%HV	NA	4.0%	0.0%	3.8%	0.0%	1.9%	NA	1.9%	NA	NA	NA	0.0%	14.0%	NA	0.0%	10.1%	2.7%
PHF	0.89	0.59	0.87	0.00	0.94	0.94			0.00	0.79	0.55	0.94	0.92				

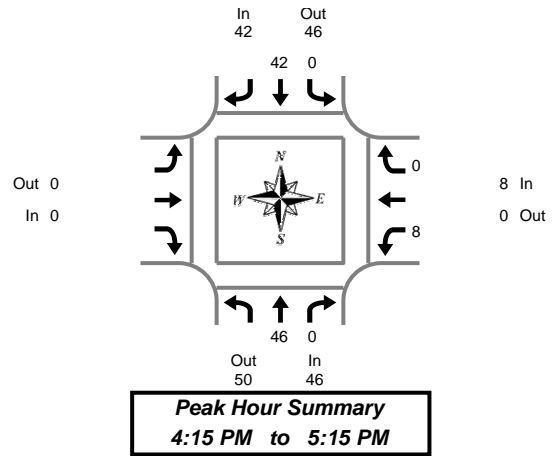
Rolling Hour Summary 3:00 PM to 6:00 PM

Interval Start Time	Northbound Hwy 99E			Southbound Hwy 99E			Eastbound SE Monroe St			Westbound SE Monroe St			Interval Total	Pedestrians Crosswalk			
	T	R	Bikes	L	T	Bikes			Bikes	L	R	Bikes		North	South	East	West
3:00 PM	1,044	48	0	0	1,905	0			0	50	51	0	3,098	0	3	1	1
3:15 PM	1,060	45	0	0	2,073	0			0	46	41	0	3,265	0	0	1	1
3:30 PM	1,096	41	0	0	2,230	1			0	42	36	0	3,445	0	0	1	1
3:45 PM	1,087	33	0	0	2,250	1			0	51	27	0	3,448	0	0	0	0
4:00 PM	1,124	39	1	0	2,226	1			0	49	23	0	3,461	0	0	1	3
4:15 PM	1,152	45	1	0	2,235	1			0	57	22	0	3,511	0	0	1	3
4:30 PM	1,118	49	1	0	2,188	0			0	63	25	0	3,443	0	0	1	3
4:45 PM	1,083	56	1	0	2,206	0			0	59	28	0	3,432	0	0	1	3
5:00 PM	1,054	53	0	0	2,237	0			0	62	25	0	3,431	0	0	0	0

Heavy Vehicle Summary



Clay Carney
(503) 833-2740



Hwy 99E & SE Monroe St

Wednesday, November 29, 2006
3:00 PM to 6:00 PM

Heavy Vehicle 15-Minute Interval Summary 3:00 PM to 6:00 PM

Interval Start Time	Northbound Hwy 99E			Southbound Hwy 99E			Eastbound SE Monroe St			Westbound SE Monroe St			Interval Total
	T	R	Total	L	T	Total			Total	L	R	Total	
3:00 PM	8	0	8	0	15	15			0	2		2	25
3:15 PM	9	1	10	0	18	18			0	2		2	30
3:30 PM	12	0	12	0	15	15			0	2		2	29
3:45 PM	13	0	13	0	20	20			0	2		2	35
4:00 PM	13	1	14	0	19	19			0	3		3	36
4:15 PM	13	0	13	0	14	14			0	1		1	28
4:30 PM	13	0	13	0	12	12			0	3		3	28
4:45 PM	8	0	8	0	10	10			0	2		2	20
5:00 PM	12	0	12	0	6	6			0	2		2	20
5:15 PM	6	0	6	0	10	10			0	4		4	20
5:30 PM	2	0	2	0	8	8			0	4		4	14
5:45 PM	6	1	7	0	5	5			0	2		2	14
Total Survey	115	3	118	0	152	152			0	29		29	299

Heavy Vehicle Peak Hour Summary 4:15 PM to 5:15 PM

By Approach	Northbound Hwy 99E			Southbound Hwy 99E			Eastbound SE Monroe St			Westbound SE Monroe St			Total
	In	Out	Total	In	Out	Total	In	Out	Total	In	Out	Total	
Volume	46	50	96	42	46	88	0	0	0	8	0	8	96
PHF	0.29			0.19			0.00			0.20			0.24

By Movement	Northbound Hwy 99E			Southbound Hwy 99E			Eastbound SE Monroe St			Westbound SE Monroe St			Total
	T	R	Total	L	T	Total			Total	L	R	Total	
Volume	46	0	46	0	42	42			0	8		8	96
PHF	0.29	0.00	0.29	0.00	0.19	0.19			0.00	0.20	0.00	0.20	0.24

Heavy Vehicle Rolling Hour Summary 3:00 PM to 6:00 PM

Interval Start Time	Northbound Hwy 99E			Southbound Hwy 99E			Eastbound SE Monroe St			Westbound SE Monroe St			Interval Total
	T	R	Total	L	T	Total			Total	L	R	Total	
3:00 PM	42	1	43	0	68	68			0	8		8	119
3:15 PM	47	2	49	0	72	72			0	9		9	130
3:30 PM	51	1	52	0	68	68			0	8		8	128
3:45 PM	52	1	53	0	65	65			0	9		9	127
4:00 PM	47	1	48	0	55	55			0	9		9	112
4:15 PM	46	0	46	0	42	42			0	8		8	96
4:30 PM	39	0	39	0	38	38			0	11		11	88
4:45 PM	28	0	28	0	34	34			0	12		12	74
5:00 PM	26	1	27	0	29	29			0	12		12	68

Peak Hour Summary

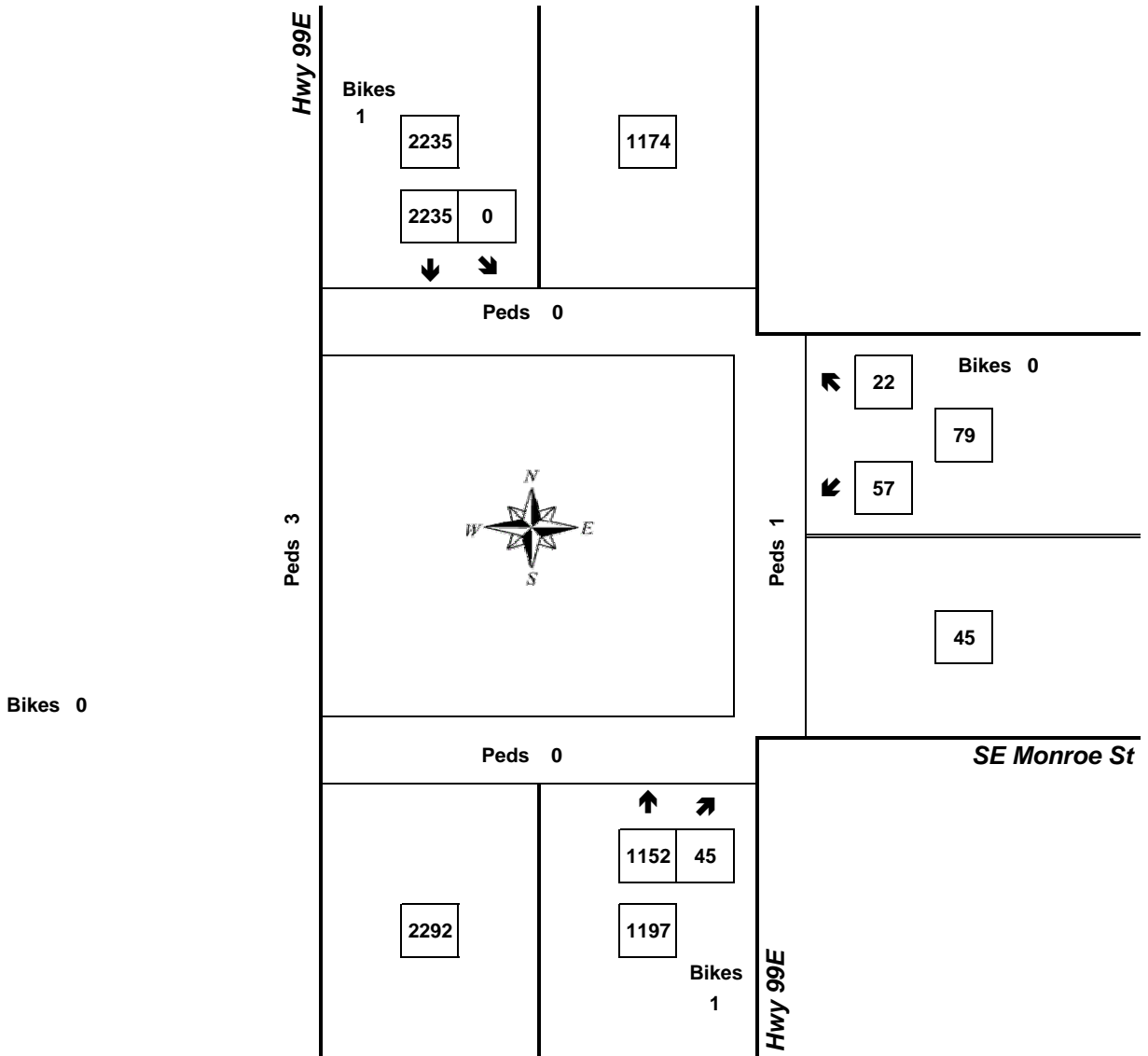


Clay Carney
(503) 833-2740

Hwy 99E & SE Monroe St

4:15 PM to 5:15 PM

Wednesday, November 29, 2006



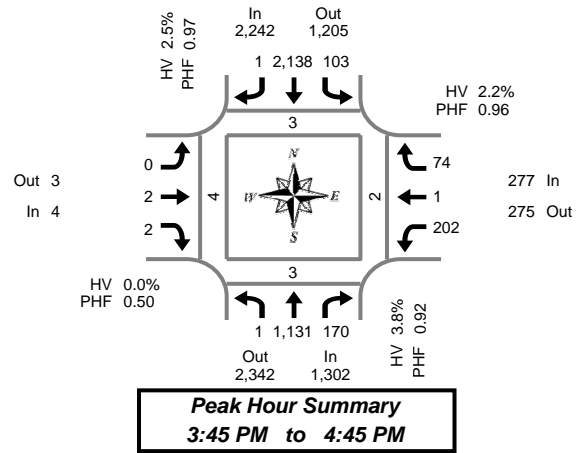
Approach	PHF	HV%	Volume
EB	0.00	0.0%	0
WB	0.94	10.1%	79
NB	0.87	3.8%	1,197
SB	0.94	1.9%	2,235
Intersection	0.92	2.7%	3,511

Count Period: 3:00 PM to 6:00 PM

Total Vehicle Summary



Clay Carney
(503) 833-2740



Hwy 99E & SE Washington St

Tuesday, December 05, 2006
3:00 PM to 6:00 PM

15-Minute Interval Summary

3:00 PM to 6:00 PM

Interval Start Time	Northbound Hwy 99E				Southbound Hwy 99E				Eastbound SE Washington St				Westbound SE Washington St				Interval Total	Pedestrians Crosswalk			
	L	T	R	Bikes	L	T	R	Bikes	L	T	R	Bikes	L	T	R	Bikes		North	South	East	West
3:00 PM	0	274	43	0	19	387	1	0	2	0	0	0	43	0	15	0	784	0	1	1	0
3:15 PM	0	265	47	0	27	461	2	0	0	0	2	0	45	0	14	0	863	0	1	1	0
3:30 PM	0	255	37	0	33	455	0	0	0	2	1	0	56	0	18	0	857	0	3	1	0
3:45 PM	0	293	48	0	32	528	0	0	0	0	0	0	57	0	15	0	973	0	1	0	0
4:00 PM	0	263	30	0	29	543	1	0	0	0	0	0	43	0	21	0	930	1	0	1	0
4:15 PM	1	302	51	0	19	512	0	0	0	1	1	0	52	1	19	0	959	1	0	0	4
4:30 PM	0	273	41	0	23	555	0	0	0	1	1	0	50	0	19	0	963	1	2	1	0
4:45 PM	0	279	25	0	26	516	0	0	0	0	0	0	38	0	23	0	907	2	1	0	1
5:00 PM	0	273	30	0	32	533	1	0	0	1	0	0	42	0	20	0	932	0	0	0	1
5:15 PM	0	289	40	0	22	570	1	0	0	0	0	0	36	0	21	0	979	3	3	3	0
5:30 PM	0	274	32	0	29	518	0	0	0	0	0	0	50	0	14	0	917	0	3	0	0
5:45 PM	0	250	25	0	24	508	0	0	0	0	1	0	30	0	9	0	847	0	0	0	0
Total Survey	1	3,290	449	0	315	6,086	6	0	2	5	6	0	542	1	208	0	10,911	8	15	8	6

Peak Hour Summary

3:45 PM to 4:45 PM

By Approach	Northbound Hwy 99E				Southbound Hwy 99E				Eastbound SE Washington St				Westbound SE Washington St				Total	Pedestrians Crosswalk			
	In	Out	Total	Bikes	In	Out	Total	Bikes	In	Out	Total	Bikes	In	Out	Total	Bikes		North	South	East	West
Volume	1,302	2,342	3,644	0	2,242	1,205	3,447	0	4	3	7	0	277	275	552	0	3,825	3	3	2	4
%HV	3.8%				2.5%				0.0%				2.2%				3.0%				
PHF	0.92				0.97				0.50				0.96				0.98				

By Movement	Northbound Hwy 99E				Southbound Hwy 99E				Eastbound SE Washington St				Westbound SE Washington St				Total
	L	T	R	Total	L	T	R	Total	L	T	R	Total	L	T	R	Total	
Volume	1	1,131	170	1,302	103	2,138	1	2,242	0	2	2	4	202	1	74	277	3,825
%HV	0.0%	4.1%	2.4%	3.8%	3.9%	2.5%	0.0%	2.5%	0.0%	0.0%	0.0%	0.0%	2.0%	0.0%	2.7%	2.2%	3.0%
PHF	0.25	0.94	0.83	0.92	0.80	0.96	0.25	0.97	0.00	0.50	0.50	0.50	0.89	0.25	0.88	0.96	0.98

Rolling Hour Summary

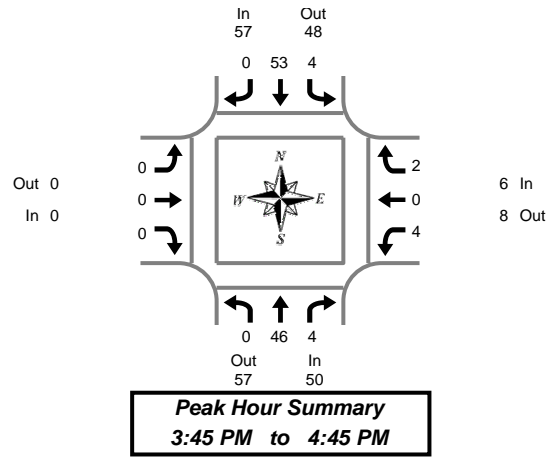
3:00 PM to 6:00 PM

Interval Start Time	Northbound Hwy 99E				Southbound Hwy 99E				Eastbound SE Washington St				Westbound SE Washington St				Interval Total	Pedestrians Crosswalk			
	L	T	R	Bikes	L	T	R	Bikes	L	T	R	Bikes	L	T	R	Bikes		North	South	East	West
3:00 PM	0	1,087	175	0	111	1,831	3	0	2	2	3	0	201	0	62	0	3,477	0	6	3	0
3:15 PM	0	1,076	162	0	121	1,987	3	0	0	2	3	0	201	0	68	0	3,623	1	5	3	0
3:30 PM	1	1,113	166	0	113	2,038	1	0	0	3	2	0	208	1	73	0	3,719	2	4	2	4
3:45 PM	1	1,131	170	0	103	2,138	1	0	0	2	2	0	202	1	74	0	3,825	3	3	2	4
4:00 PM	1	1,117	147	0	97	2,126	1	0	0	2	2	0	183	1	82	0	3,759	5	3	2	5
4:15 PM	1	1,127	147	0	100	2,116	1	0	0	3	2	0	182	1	81	0	3,761	4	3	1	6
4:30 PM	0	1,114	136	0	103	2,174	2	0	0	2	1	0	166	0	83	0	3,781	6	6	4	2
4:45 PM	0	1,115	127	0	109	2,137	2	0	0	1	0	0	166	0	78	0	3,735	5	7	3	2
5:00 PM	0	1,086	127	0	107	2,129	2	0	0	1	1	0	158	0	64	0	3,675	3	6	3	1

Heavy Vehicle Summary



Clay Carney
(503) 833-2740



Hwy 99E & SE Washington St

Tuesday, December 05, 2006
3:00 PM to 6:00 PM

Heavy Vehicle 15-Minute Interval Summary 3:00 PM to 6:00 PM

Interval Start Time	Northbound Hwy 99E				Southbound Hwy 99E				Eastbound SE Washington St				Westbound SE Washington St				Interval Total
	L	T	R	Total	L	T	R	Total	L	T	R	Total	L	T	R	Total	
3:00 PM	0	20	0	20	1	12	1	14	0	0	0	0	2	0	0	2	36
3:15 PM	0	11	1	12	3	13	1	17	0	0	0	0	1	0	0	1	30
3:30 PM	0	9	1	10	1	20	0	21	0	0	0	0	0	0	1	1	32
3:45 PM	0	12	1	13	4	14	0	18	0	0	0	0	0	0	0	0	31
4:00 PM	0	12	0	12	0	19	0	19	0	0	0	0	1	0	0	1	32
4:15 PM	0	12	2	14	0	9	0	9	0	0	0	0	0	0	0	0	23
4:30 PM	0	10	1	11	0	11	0	11	0	0	0	0	3	0	2	5	27
4:45 PM	0	9	1	10	0	11	0	11	0	0	0	0	0	0	1	1	22
5:00 PM	0	10	2	12	0	12	0	12	0	0	0	0	1	0	1	2	26
5:15 PM	0	9	0	9	2	8	0	10	0	0	0	0	0	0	0	0	19
5:30 PM	0	5	1	6	0	8	0	8	0	0	0	0	0	0	1	1	15
5:45 PM	0	5	1	6	0	8	0	8	0	0	0	0	0	0	1	1	15
Total Survey	0	124	11	135	11	145	2	158	0	0	0	0	8	0	7	15	308

Heavy Vehicle Peak Hour Summary 3:45 PM to 4:45 PM

By Approach	Northbound Hwy 99E			Southbound Hwy 99E			Eastbound SE Washington St			Westbound SE Washington St			Total
	In	Out	Total	In	Out	Total	In	Out	Total	In	Out	Total	
Volume	50	57	107	57	48	105	0	0	0	6	8	14	113
PHF	0.30			0.25			0.00			0.19			0.29

By Movement	Northbound Hwy 99E				Southbound Hwy 99E				Eastbound SE Washington St				Westbound SE Washington St				Total
	L	T	R	Total	L	T	R	Total	L	T	R	Total	L	T	R	Total	
Volume	0	46	4	50	4	53	0	57	0	0	0	0	4	0	2	6	113
PHF	0.00	0.29	0.25	0.30	0.13	0.25	0.00	0.25	0.00	0.00	0.00	0.00	0.25	0.00	0.13	0.19	0.29

Heavy Vehicle Rolling Hour Summary 3:00 PM to 6:00 PM

Interval Start Time	Northbound Hwy 99E				Southbound Hwy 99E				Eastbound SE Washington St				Westbound SE Washington St				Interval Total
	L	T	R	Total	L	T	R	Total	L	T	R	Total	L	T	R	Total	
3:00 PM	0	52	3	55	9	59	2	70	0	0	0	0	3	0	1	4	129
3:15 PM	0	44	3	47	8	66	1	75	0	0	0	0	2	0	1	3	125
3:30 PM	0	45	4	49	5	62	0	67	0	0	0	0	1	0	1	2	118
3:45 PM	0	46	4	50	4	53	0	57	0	0	0	0	4	0	2	6	113
4:00 PM	0	43	4	47	0	50	0	50	0	0	0	0	4	0	3	7	104
4:15 PM	0	41	6	47	0	43	0	43	0	0	0	0	4	0	4	8	98
4:30 PM	0	38	4	42	2	42	0	44	0	0	0	0	4	0	4	8	94
4:45 PM	0	33	4	37	2	39	0	41	0	0	0	0	1	0	3	4	82
5:00 PM	0	29	4	33	2	36	0	38	0	0	0	0	1	0	3	4	75

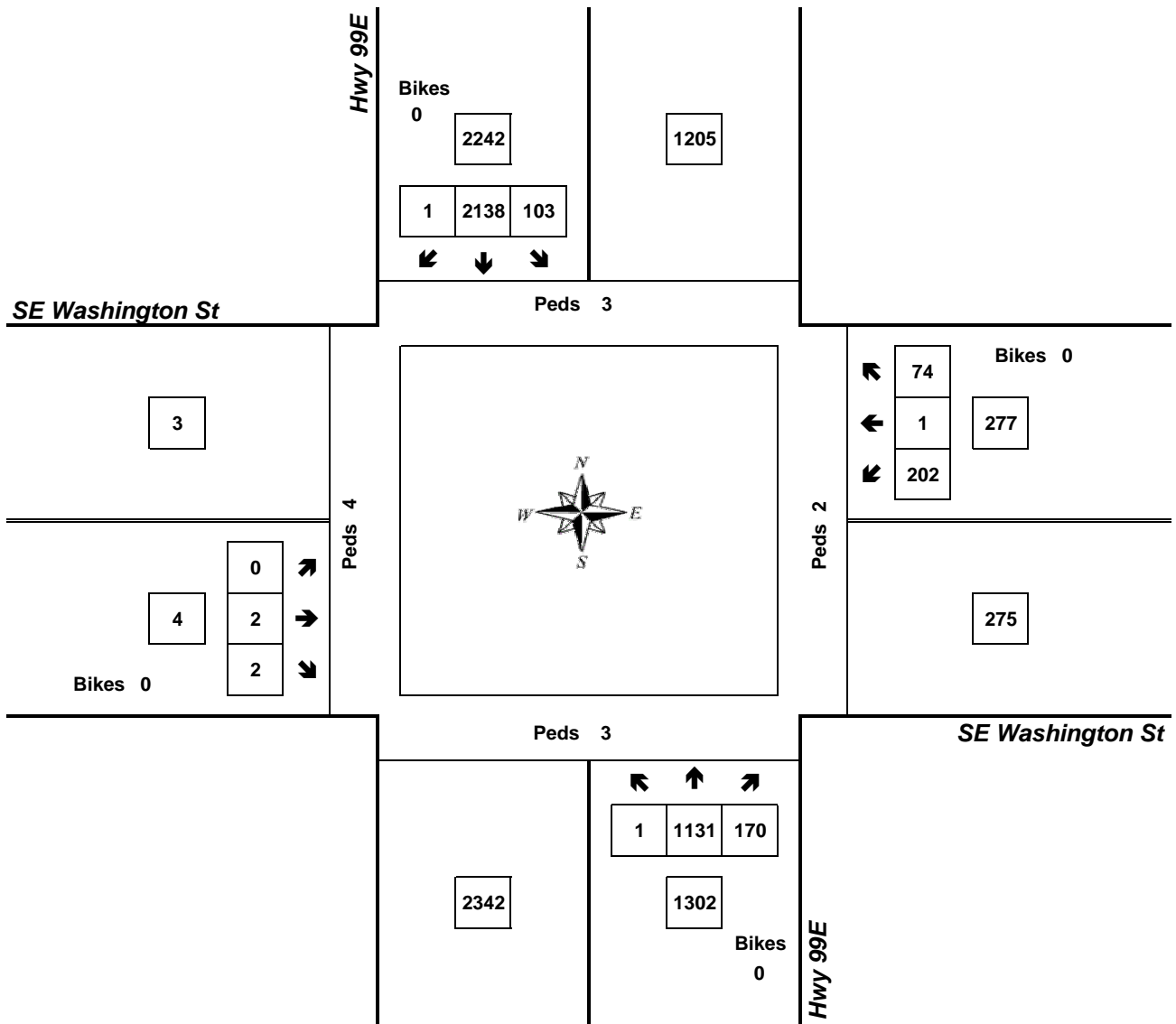
Peak Hour Summary



Clay Carney
(503) 833-2740

Hwy 99E & SE Washington St

3:45 PM to 4:45 PM
Tuesday, December 05, 2006



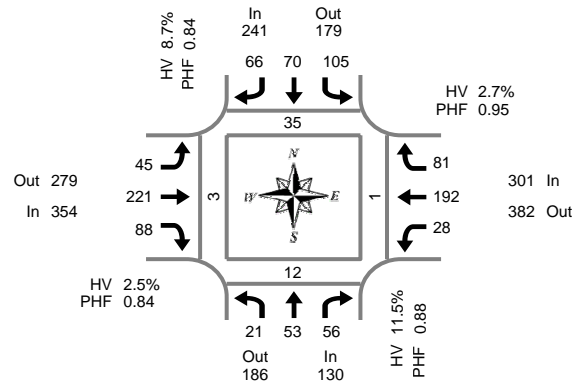
Approach	PHF	HV%	Volume
EB	0.50	0.0%	4
WB	0.96	2.2%	277
NB	0.92	3.8%	1,302
SB	0.97	2.5%	2,242
Intersection	0.98	3.0%	3,825

Count Period: 3:00 PM to 6:00 PM

Total Vehicle Summary



Clay Carney
(503) 833-2740



SE Main St & SE Harrison St

Wednesday, November 29, 2006
3:00 PM to 6:00 PM

15-Minute Interval Summary 3:00 PM to 6:00 PM

Interval Start Time	Northbound SE Main St				Southbound SE Main St				Eastbound SE Harrison St				Westbound SE Harrison St				Interval Total	Pedestrians Crosswalk			
	L	T	R	Bikes	L	T	R	Bikes	L	T	R	Bikes	L	T	R	Bikes		North	South	East	West
3:00 PM	5	7	6	0	22	19	9	0	14	56	21	0	12	46	18	0	235	7	1	2	7
3:15 PM	6	8	11	0	17	15	16	0	12	54	20	0	11	39	21	0	230	5	7	3	1
3:30 PM	6	12	14	0	19	17	13	2	11	67	13	0	9	50	26	0	257	4	9	8	1
3:45 PM	4	14	11	0	10	14	11	0	13	61	21	0	16	50	21	0	246	11	9	6	3
4:00 PM	13	15	7	0	18	22	25	0	13	53	23	0	12	49	24	0	274	0	4	7	3
4:15 PM	7	11	9	0	19	20	12	0	14	53	22	0	9	43	14	0	233	7	3	3	1
4:30 PM	5	9	11	1	29	22	11	0	9	67	24	0	8	43	17	0	255	5	1	5	3
4:45 PM	5	16	13	0	15	15	15	0	18	58	17	0	13	49	16	0	250	0	3	0	0
5:00 PM	4	11	14	0	31	23	18	0	10	52	21	0	6	50	23	0	263	6	5	0	1
5:15 PM	6	13	11	0	29	14	10	0	5	71	29	0	2	46	21	0	257	2	3	0	1
5:30 PM	6	13	18	0	30	18	23	0	12	40	21	0	7	47	21	0	256	27	1	1	1
5:45 PM	6	10	7	0	22	15	14	0	14	41	17	0	13	40	12	0	211	4	2	2	0
Total Survey	73	139	132	1	261	214	177	2	145	673	249	0	118	552	234	0	2,967	78	48	37	22

Peak Hour Summary 4:45 PM to 5:45 PM

By Approach	Northbound SE Main St				Southbound SE Main St				Eastbound SE Harrison St				Westbound SE Harrison St				Total	Pedestrians Crosswalk			
	In	Out	Total	Bikes	In	Out	Total	Bikes	In	Out	Total	Bikes	In	Out	Total	Bikes		North	South	East	West
Volume	130	186	316	0	241	179	420	0	354	279	633	0	301	382	683	0	1,026	35	12	1	3
%HV	11.5%				8.7%				2.5%				2.7%				5.2%				
PHF	0.88				0.84				0.84				0.95				0.98				

By Movement	Northbound SE Main St				Southbound SE Main St				Eastbound SE Harrison St				Westbound SE Harrison St				Total
	L	T	R	Total	L	T	R	Total	L	T	R	Total	L	T	R	Total	
Volume	21	53	56	130	105	70	66	241	45	221	88	354	28	192	81	301	1,026
%HV	19.0%	18.9%	1.8%	11.5%	6.7%	18.6%	1.5%	8.7%	0.0%	3.6%	1.1%	2.5%	14.3%	1.0%	2.5%	2.7%	5.2%
PHF	0.88	0.83	0.78	0.88	0.85	0.76	0.72	0.84	0.63	0.78	0.76	0.84	0.54	0.96	0.88	0.95	0.98

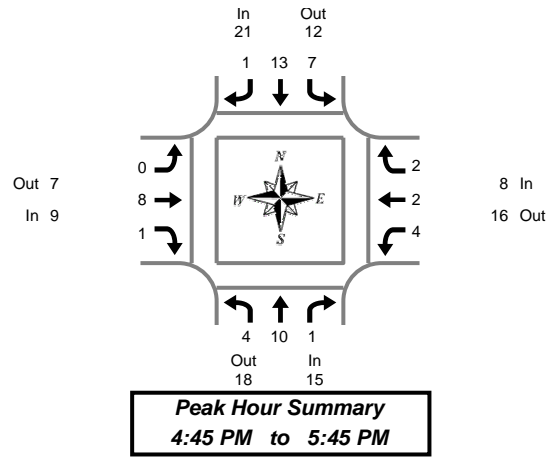
Rolling Hour Summary 3:00 PM to 6:00 PM

Interval Start Time	Northbound SE Main St				Southbound SE Main St				Eastbound SE Harrison St				Westbound SE Harrison St				Interval Total	Pedestrians Crosswalk			
	L	T	R	Bikes	L	T	R	Bikes	L	T	R	Bikes	L	T	R	Bikes		North	South	East	West
3:00 PM	21	41	42	0	68	65	49	2	50	238	75	0	48	185	86	0	968	27	26	19	12
3:15 PM	29	49	43	0	64	68	65	2	49	235	77	0	48	188	92	0	1,007	20	29	24	8
3:30 PM	30	52	41	0	66	73	61	2	51	234	79	0	46	192	85	0	1,010	22	25	24	8
3:45 PM	29	49	38	1	76	78	59	0	49	234	90	0	45	185	76	0	1,008	23	17	21	10
4:00 PM	30	51	40	1	81	79	63	0	54	231	86	0	42	184	71	0	1,012	12	11	15	7
4:15 PM	21	47	47	1	94	80	56	0	51	230	84	0	36	185	70	0	1,001	18	12	8	5
4:30 PM	20	49	49	1	104	74	54	0	42	248	91	0	29	188	77	0	1,025	13	12	5	5
4:45 PM	21	53	56	0	105	70	66	0	45	221	88	0	28	192	81	0	1,026	35	12	1	3
5:00 PM	22	47	50	0	112	70	65	0	41	204	88	0	28	183	77	0	987	39	11	3	3

Heavy Vehicle Summary



Clay Carney
(503) 833-2740



SE Main St & SE Harrison St

Wednesday, November 29, 2006
3:00 PM to 6:00 PM

Heavy Vehicle 15-Minute Interval Summary 3:00 PM to 6:00 PM

Interval Start Time	Northbound SE Main St				Southbound SE Main St				Eastbound SE Harrison St				Westbound SE Harrison St				Interval Total
	L	T	R	Total	L	T	R	Total	L	T	R	Total	L	T	R	Total	
3:00 PM	1	2	0	3	1	2	1	4	1	1	0	2	2	3	0	5	14
3:15 PM	1	1	1	3	0	2	1	3	0	1	0	1	1	1	1	3	10
3:30 PM	1	1	1	3	0	2	0	2	0	2	0	2	0	0	2	2	9
3:45 PM	1	3	1	5	2	3	0	5	3	3	1	7	3	3	1	7	24
4:00 PM	1	0	1	2	1	2	1	4	0	5	2	7	1	1	2	4	17
4:15 PM	2	2	0	4	0	2	0	2	2	1	2	5	2	0	1	3	14
4:30 PM	1	3	0	4	2	3	2	7	0	3	0	3	0	0	0	0	14
4:45 PM	1	5	0	6	0	4	0	4	0	3	1	4	1	1	0	2	16
5:00 PM	1	2	1	4	3	4	1	8	0	3	0	3	1	0	0	1	16
5:15 PM	1	1	0	2	1	1	0	2	0	2	0	2	1	1	1	3	9
5:30 PM	1	2	0	3	3	4	0	7	0	0	0	0	1	0	1	2	12
5:45 PM	1	1	0	2	0	3	0	3	0	2	0	2	1	1	0	2	9
Total Survey	13	23	5	41	13	32	6	51	6	26	6	38	14	11	9	34	164

Heavy Vehicle Peak Hour Summary 4:45 PM to 5:45 PM

By Approach	Northbound SE Main St			Southbound SE Main St			Eastbound SE Harrison St			Westbound SE Harrison St			Total
	In	Out	Total	In	Out	Total	In	Out	Total	In	Out	Total	
Volume	15	18	33	21	12	33	9	7	16	8	16	24	53
PHF	0.27			0.28			0.12			0.14			0.24

By Movement	Northbound SE Main St				Southbound SE Main St				Eastbound SE Harrison St				Westbound SE Harrison St				Total
	L	T	R	Total	L	T	R	Total	L	T	R	Total	L	T	R	Total	
Volume	4	10	1	15	7	13	1	21	0	8	1	9	4	2	2	8	53
PHF	0.25	0.25	0.08	0.27	0.25	0.30	0.08	0.28	0.00	0.20	0.05	0.12	0.17	0.13	0.10	0.14	0.24

Heavy Vehicle Rolling Hour Summary 3:00 PM to 6:00 PM

Interval Start Time	Northbound SE Main St				Southbound SE Main St				Eastbound SE Harrison St				Westbound SE Harrison St				Interval Total
	L	T	R	Total	L	T	R	Total	L	T	R	Total	L	T	R	Total	
3:00 PM	4	7	3	14	3	9	2	14	4	7	1	12	6	7	4	17	57
3:15 PM	4	5	4	13	3	9	2	14	3	11	3	17	5	5	6	16	60
3:30 PM	5	6	3	14	3	9	1	13	5	11	5	21	6	4	6	16	64
3:45 PM	5	8	2	15	5	10	3	18	5	12	5	22	6	4	4	14	69
4:00 PM	5	10	1	16	3	11	3	17	2	12	5	19	4	2	3	9	61
4:15 PM	5	12	1	18	5	13	3	21	2	10	3	15	4	1	1	6	60
4:30 PM	4	11	1	16	6	12	3	21	0	11	1	12	3	2	1	6	55
4:45 PM	4	10	1	15	7	13	1	21	0	8	1	9	4	2	2	8	53
5:00 PM	4	6	1	11	7	12	1	20	0	7	0	7	4	2	2	8	46

Peak Hour Summary

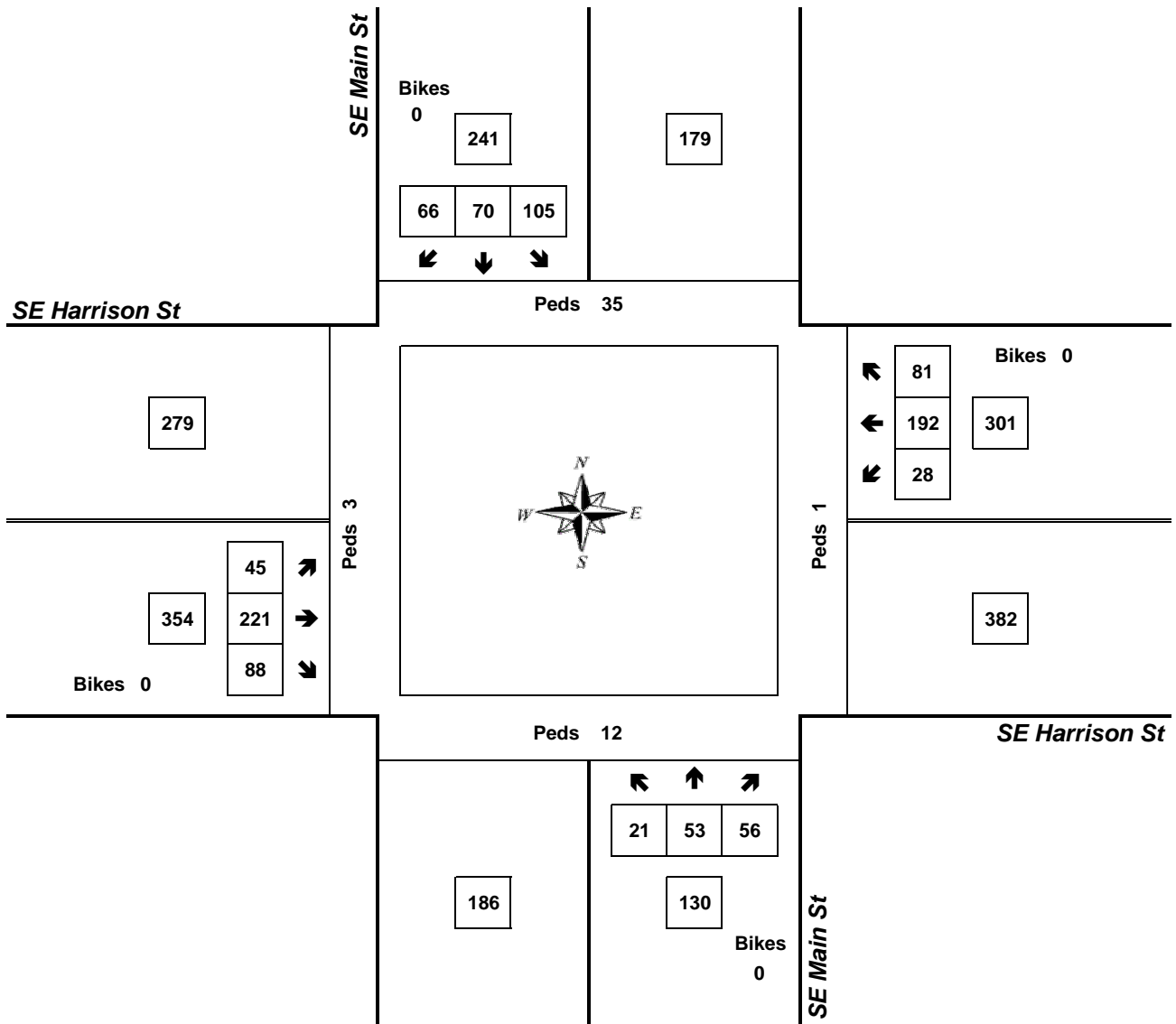


Clay Carney
(503) 833-2740

SE Main St & SE Harrison St

4:45 PM to 5:45 PM

Wednesday, November 29, 2006



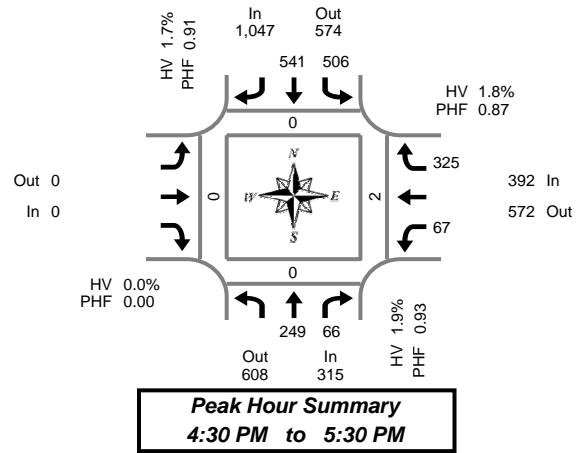
Approach	PHF	HV%	Volume
EB	0.84	2.5%	354
WB	0.95	2.7%	301
NB	0.88	11.5%	130
SB	0.84	8.7%	241
Intersection	0.98	5.2%	1,026

Count Period: 3:00 PM to 6:00 PM

Total Vehicle Summary



Clay Carney
(503) 833-2740



SE 17th Ave & Hwy 224

Wednesday, November 29, 2006
3:00 PM to 6:00 PM

15-Minute Interval Summary 3:00 PM to 6:00 PM

Interval Start Time	Northbound SE 17th Ave			Southbound SE 17th Ave			Eastbound Hwy 224			Westbound Hwy 224			Interval Total	Pedestrians Crosswalk			
	T	R	Bikes	L	T	Bikes			Bikes	L	R	Bikes		North	South	East	West
3:00 PM	64	18	0	84	89	0			0	18	64	0	337	0	0	0	0
3:15 PM	63	17	0	86	72	0			0	20	78	0	336	0	0	0	0
3:30 PM	55	11	1	113	104	0			0	13	95	0	391	0	0	1	0
3:45 PM	59	15	0	107	102	0			0	19	78	0	380	0	0	0	0
4:00 PM	68	15	0	111	135	1			0	18	81	0	428	0	0	0	0
4:15 PM	63	16	0	100	142	0			0	17	56	0	394	0	0	1	0
4:30 PM	67	18	0	126	146	0			0	24	67	0	448	0	0	0	0
4:45 PM	63	15	0	113	138	0			0	14	78	0	421	0	0	0	0
5:00 PM	59	20	0	152	137	0			0	13	100	0	481	0	0	1	0
5:15 PM	60	13	1	115	120	0			0	16	80	0	404	0	0	1	0
5:30 PM	57	19	0	108	116	0			0	20	53	0	373	0	0	0	0
5:45 PM	62	10	0	128	111	0			0	17	64	0	392	0	0	1	0
Total Survey	740	187	2	1,343	1,412	1			0	209	894	0	4,785	0	0	5	0

Peak Hour Summary 4:30 PM to 5:30 PM

By Approach	Northbound SE 17th Ave				Southbound SE 17th Ave				Eastbound Hwy 224				Westbound Hwy 224				Total	Pedestrians Crosswalk				
	In	Out	Total	Bikes	In	Out	Total	Bikes	In	Out	Total	Bikes	In	Out	Total	Bikes		North	South	East	West	
Volume	315	608	923	1	1,047	574	1,621	0	0	0	0	0	392	572	964	0	1,754	0	0	2	0	
%HV	1.9%				1.7%				0.0%				1.8%				1.8%					
PHF	0.93				0.91				0.00				0.87				0.91					

By Movement	Northbound SE 17th Ave			Southbound SE 17th Ave			Eastbound Hwy 224			Westbound Hwy 224			Total	
	T	R	Total	L	T	Total			Total	L	R	Total		
Volume	249	66	315	506	541	1,047			0	67	325	392	1,754	
%HV	NA	2.4%	0.0%	1.9%	1.8%	1.7%	NA	1.7%	NA	NA	0.0%	1.5%	1.8%	1.8%
PHF	0.93	0.83	0.93	0.83	0.93	0.91			0.00	0.70	0.81	0.87	0.91	

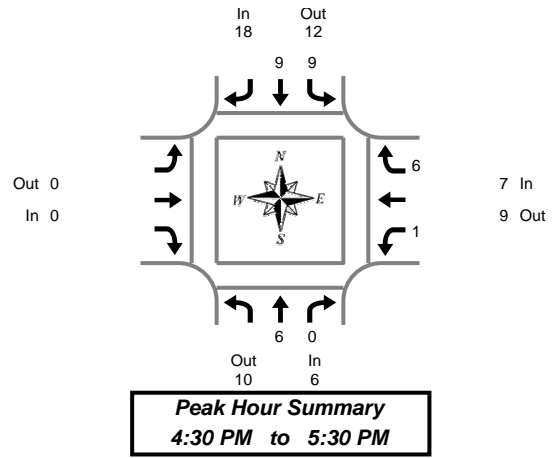
Rolling Hour Summary 3:00 PM to 6:00 PM

Interval Start Time	Northbound SE 17th Ave			Southbound SE 17th Ave			Eastbound Hwy 224			Westbound Hwy 224			Interval Total	Pedestrians Crosswalk			
	T	R	Bikes	L	T	Bikes			Bikes	L	R	Bikes		North	South	East	West
3:00 PM	241	61	1	390	367	0			0	70	315	0	1,444	0	0	1	0
3:15 PM	245	58	1	417	413	1			0	70	332	0	1,535	0	0	1	0
3:30 PM	245	57	1	431	483	1			0	67	310	0	1,593	0	0	2	0
3:45 PM	257	64	0	444	525	1			0	78	282	0	1,650	0	0	1	0
4:00 PM	261	64	0	450	561	1			0	73	282	0	1,691	0	0	1	0
4:15 PM	252	69	0	491	563	0			0	68	301	0	1,744	0	0	2	0
4:30 PM	249	66	1	506	541	0			0	67	325	0	1,754	0	0	2	0
4:45 PM	239	67	1	488	511	0			0	63	311	0	1,679	0	0	2	0
5:00 PM	238	62	1	503	484	0			0	66	297	0	1,650	0	0	3	0

Heavy Vehicle Summary



Clay Carney
(503) 833-2740



SE 17th Ave & Hwy 224

Wednesday, November 29, 2006
3:00 PM to 6:00 PM

Heavy Vehicle 15-Minute Interval Summary 3:00 PM to 6:00 PM

Interval Start Time	Northbound SE 17th Ave			Southbound SE 17th Ave			Eastbound Hwy 224			Westbound Hwy 224			Interval Total
	T	R	Total	L	T	Total			Total	L	R	Total	
3:00 PM	1	2	3	3	2	5			0	1	3	4	12
3:15 PM	1	0	1	3	1	4			0	3	4	7	12
3:30 PM	1	1	2	1	3	4			0	0	2	2	8
3:45 PM	1	3	4	1	4	5			0	1	1	2	11
4:00 PM	2	0	2	1	6	7			0	1	1	2	11
4:15 PM	4	1	5	3	4	7			0	0	1	1	13
4:30 PM	2	0	2	3	5	8			0	0	3	3	13
4:45 PM	1	0	1	3	0	3			0	0	1	1	5
5:00 PM	1	0	1	0	2	2			0	0	1	1	4
5:15 PM	2	0	2	3	2	5			0	1	1	2	9
5:30 PM	1	0	1	2	0	2			0	0	0	0	3
5:45 PM	3	0	3	1	3	4			0	0	1	1	8
Total Survey	20	7	27	24	32	56			0	7	19	26	109

Heavy Vehicle Peak Hour Summary 4:30 PM to 5:30 PM

By Approach	Northbound SE 17th Ave			Southbound SE 17th Ave			Eastbound Hwy 224			Westbound Hwy 224			Total
	In	Out	Total	In	Out	Total	In	Out	Total	In	Out	Total	
Volume	6	10	16	18	12	30	0	0	0	7	9	16	31
PHF	0.14			0.20			0.00			0.13			0.21

By Movement	Northbound SE 17th Ave			Southbound SE 17th Ave			Eastbound Hwy 224			Westbound Hwy 224			Total
	T	R	Total	L	T	Total			Total	L	R	Total	
Volume	6	0	6	9	9	18			0	1	6	7	31
PHF	0.19	0.00	0.14	0.25	0.15	0.20			0.00	0.06	0.17	0.13	0.21

Heavy Vehicle Rolling Hour Summary 3:00 PM to 6:00 PM

Interval Start Time	Northbound SE 17th Ave			Southbound SE 17th Ave			Eastbound Hwy 224			Westbound Hwy 224			Interval Total
	T	R	Total	L	T	Total			Total	L	R	Total	
3:00 PM	4	6	10	8	10	18			0	5	10	15	43
3:15 PM	5	4	9	6	14	20			0	5	8	13	42
3:30 PM	8	5	13	6	17	23			0	2	5	7	43
3:45 PM	9	4	13	8	19	27			0	2	6	8	48
4:00 PM	9	1	10	10	15	25			0	1	6	7	42
4:15 PM	8	1	9	9	11	20			0	0	6	6	35
4:30 PM	6	0	6	9	9	18			0	1	6	7	31
4:45 PM	5	0	5	8	4	12			0	1	3	4	21
5:00 PM	7	0	7	6	7	13			0	1	3	4	24

Peak Hour Summary

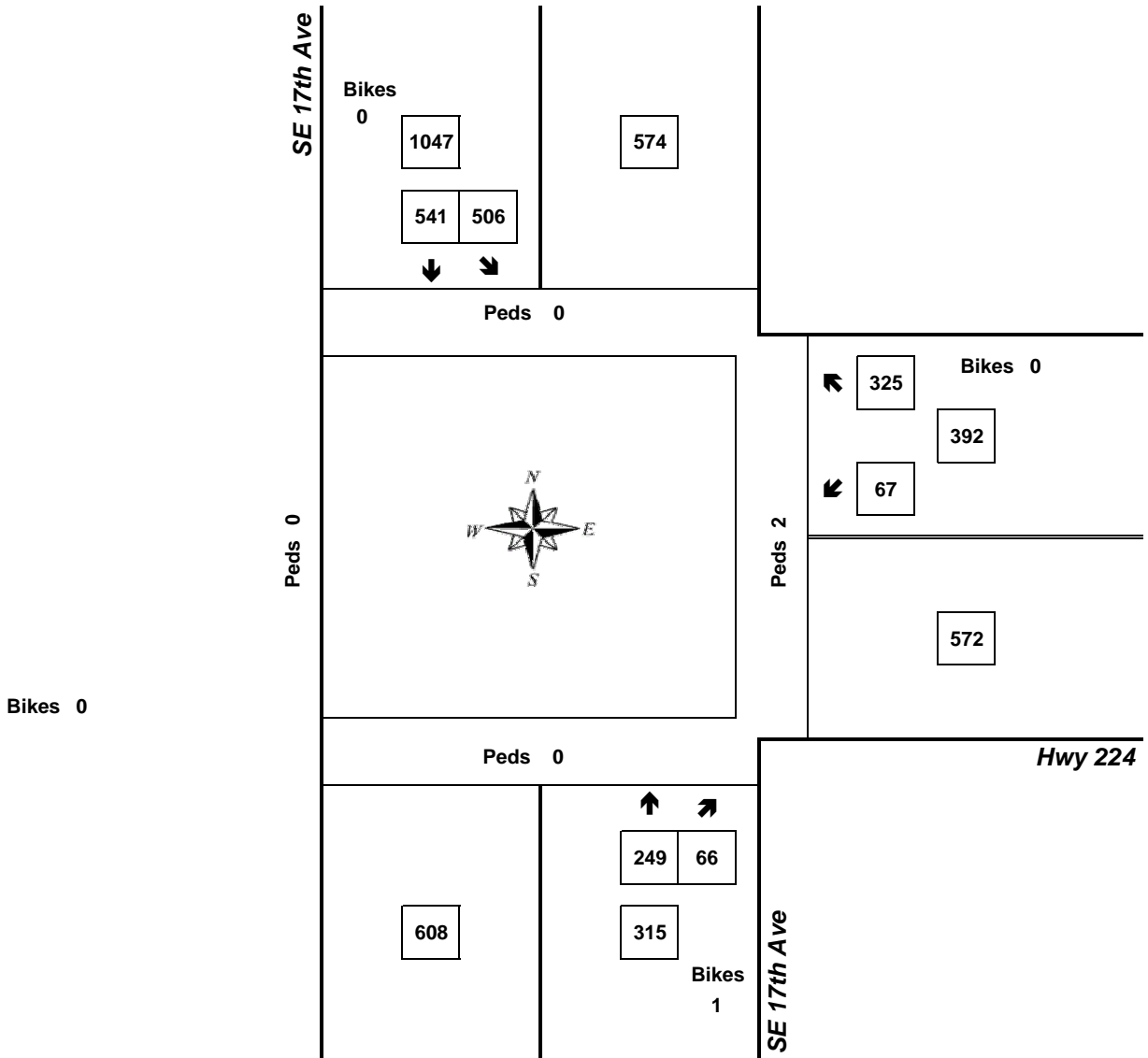


Clay Carney
(503) 833-2740

SE 17th Ave & Hwy 224

4:30 PM to 5:30 PM

Wednesday, November 29, 2006



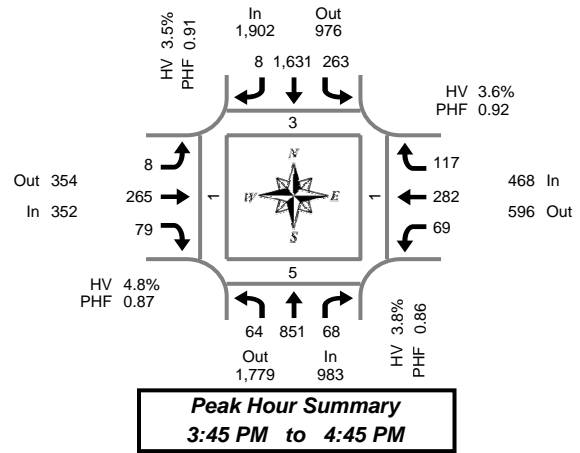
Approach	PHF	HV%	Volume
EB	0.00	0.0%	0
WB	0.87	1.8%	392
NB	0.93	1.9%	315
SB	0.91	1.7%	1,047
Intersection	0.91	1.8%	1,754

Count Period: 3:00 PM to 6:00 PM

Total Vehicle Summary



Clay Carney
(503) 833-2740



Hwy 224 & SE Harrison St

Thursday, December 07, 2006
3:00 PM to 6:00 PM

15-Minute Interval Summary

3:00 PM to 6:00 PM

Interval Start Time	Northbound Hwy 224				Southbound Hwy 224				Eastbound SE Harrison St				Westbound SE Harrison St				Interval Total	Pedestrians Crosswalk			
	L	T	R	Bikes	L	T	R	Bikes	L	T	R	Bikes	L	T	R	Bikes		North	South	East	West
3:00 PM	26	190	22	0	44	276	8	0	0	80	32	0	23	62	30	0	793	1	5	0	0
3:15 PM	20	180	19	0	41	328	6	0	5	77	19	0	28	66	22	0	811	4	1	0	0
3:30 PM	20	207	25	0	36	324	6	0	1	89	20	0	19	50	42	0	839	1	3	1	0
3:45 PM	23	212	25	0	66	359	3	0	4	57	25	0	12	82	27	0	895	1	2	0	0
4:00 PM	13	197	19	0	74	449	1	0	0	58	17	0	17	76	34	0	955	0	1	0	0
4:15 PM	12	261	14	0	53	435	1	0	0	71	19	0	19	62	30	1	977	0	0	0	0
4:30 PM	16	181	10	0	70	388	3	0	4	79	18	0	21	62	26	0	878	2	2	1	1
4:45 PM	19	171	14	0	74	367	3	0	2	78	23	0	22	64	32	0	869	0	0	0	0
5:00 PM	9	232	17	0	59	398	3	0	3	72	27	0	23	46	26	1	915	3	1	1	0
5:15 PM	10	176	18	0	51	389	3	0	1	75	18	0	29	40	29	0	839	0	1	1	0
5:30 PM	9	219	15	1	51	421	2	0	3	83	17	0	15	61	19	0	915	0	1	0	0
5:45 PM	14	144	16	0	65	348	0	0	0	69	18	0	16	60	31	0	781	1	2	0	0
Total Survey	191	2,370	214	1	684	4,482	39	0	23	888	253	0	244	731	348	2	10,467	13	19	4	1

Peak Hour Summary

3:45 PM to 4:45 PM

By Approach	Northbound Hwy 224				Southbound Hwy 224				Eastbound SE Harrison St				Westbound SE Harrison St				Total	Pedestrians Crosswalk			
	In	Out	Total	Bikes	In	Out	Total	Bikes	In	Out	Total	Bikes	In	Out	Total	Bikes		North	South	East	West
Volume	983	1,779	2,762	0	1,902	976	2,878	0	352	354	706	0	468	596	1,064	1	3,705	3	5	1	1
%HV	3.8%				3.5%				4.8%				3.6%				3.7%				
PHF	0.86				0.91				0.87				0.92				0.95				

By Movement	Northbound Hwy 224				Southbound Hwy 224				Eastbound SE Harrison St				Westbound SE Harrison St				Total
	L	T	R	Total	L	T	R	Total	L	T	R	Total	L	T	R	Total	
Volume	64	851	68	983	263	1,631	8	1,902	8	265	79	352	69	282	117	468	3,705
%HV	6.3%	3.9%	0.0%	3.8%	1.5%	3.7%	12.5%	3.5%	0.0%	5.3%	3.8%	4.8%	4.3%	3.5%	3.4%	3.6%	3.7%
PHF	0.70	0.82	0.68	0.86	0.89	0.91	0.67	0.91	0.50	0.84	0.79	0.87	0.82	0.86	0.86	0.92	0.95

Rolling Hour Summary

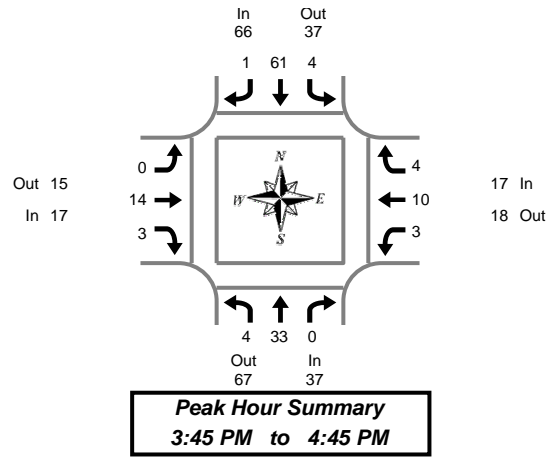
3:00 PM to 6:00 PM

Interval Start Time	Northbound Hwy 224				Southbound Hwy 224				Eastbound SE Harrison St				Westbound SE Harrison St				Interval Total	Pedestrians Crosswalk			
	L	T	R	Bikes	L	T	R	Bikes	L	T	R	Bikes	L	T	R	Bikes		North	South	East	West
3:00 PM	89	789	91	0	187	1,287	23	0	10	303	96	0	82	260	121	0	3,338	7	11	1	0
3:15 PM	76	796	88	0	217	1,460	16	0	10	281	81	0	76	274	125	0	3,500	6	7	1	0
3:30 PM	68	877	83	0	229	1,567	11	0	5	275	81	0	67	270	133	1	3,666	2	6	1	0
3:45 PM	64	851	68	0	263	1,631	8	0	8	265	79	0	69	282	117	1	3,705	3	5	1	1
4:00 PM	60	810	57	0	271	1,639	8	0	6	286	77	0	79	264	122	1	3,679	2	3	1	1
4:15 PM	56	845	55	0	256	1,588	10	0	9	300	87	0	85	234	114	2	3,639	5	3	2	1
4:30 PM	54	760	59	0	254	1,542	12	0	10	304	86	0	95	212	113	1	3,501	5	4	3	1
4:45 PM	47	798	64	1	235	1,575	11	0	9	308	85	0	89	211	106	1	3,538	3	3	2	0
5:00 PM	42	771	66	1	226	1,556	8	0	7	299	80	0	83	207	105	1	3,450	4	5	2	0

Heavy Vehicle Summary



Clay Carney
(503) 833-2740



Hwy 224 & SE Harrison St

Thursday, December 07, 2006
3:00 PM to 6:00 PM

Heavy Vehicle 15-Minute Interval Summary 3:00 PM to 6:00 PM

Interval Start Time	Northbound Hwy 224				Southbound Hwy 224				Eastbound SE Harrison St				Westbound SE Harrison St				Interval Total
	L	T	R	Total	L	T	R	Total	L	T	R	Total	L	T	R	Total	
3:00 PM	2	13	1	16	2	25	1	28	0	5	0	5	1	4	3	8	57
3:15 PM	2	16	2	20	3	27	0	30	0	3	2	5	2	6	0	8	63
3:30 PM	1	16	0	17	1	14	0	15	0	3	2	5	1	0	2	3	40
3:45 PM	1	16	0	17	1	16	0	17	0	2	2	4	1	5	0	6	44
4:00 PM	0	4	0	4	0	25	0	25	0	5	1	6	1	1	2	4	39
4:15 PM	1	6	0	7	2	10	0	12	0	3	0	3	0	1	2	3	25
4:30 PM	2	7	0	9	1	10	1	12	0	4	0	4	1	3	0	4	29
4:45 PM	1	6	0	7	1	4	1	6	0	5	0	5	0	2	0	2	20
5:00 PM	1	7	0	8	0	8	0	8	0	4	0	4	0	3	0	3	23
5:15 PM	0	6	0	6	0	6	0	6	0	3	0	3	0	5	0	5	20
5:30 PM	0	8	0	8	0	7	0	7	0	4	0	4	0	2	1	3	22
5:45 PM	0	2	0	2	0	9	0	9	0	2	0	2	0	4	1	5	18
Total Survey	11	107	3	121	11	161	3	175	0	43	7	50	7	36	11	54	400

Heavy Vehicle Peak Hour Summary 3:45 PM to 4:45 PM

By Approach	Northbound Hwy 224			Southbound Hwy 224			Eastbound SE Harrison St			Westbound SE Harrison St			Total
	In	Out	Total	In	Out	Total	In	Out	Total	In	Out	Total	
Volume	37	67	104	66	37	103	17	15	32	17	18	35	137
PHF	0.17			0.23			0.28			0.22			0.21

By Movement	Northbound Hwy 224				Southbound Hwy 224				Eastbound SE Harrison St				Westbound SE Harrison St				Total
	L	T	R	Total	L	T	R	Total	L	T	R	Total	L	T	R	Total	
Volume	4	33	0	37	4	61	1	66	0	14	3	17	3	10	4	17	137
PHF	0.20	0.17	0.00	0.17	0.17	0.23	0.13	0.23	0.00	0.27	0.13	0.28	0.19	0.23	0.20	0.22	0.21

Heavy Vehicle Rolling Hour Summary 3:00 PM to 6:00 PM

Interval Start Time	Northbound Hwy 224				Southbound Hwy 224				Eastbound SE Harrison St				Westbound SE Harrison St				Interval Total
	L	T	R	Total	L	T	R	Total	L	T	R	Total	L	T	R	Total	
3:00 PM	6	61	3	70	7	82	1	90	0	13	6	19	5	15	5	25	204
3:15 PM	4	52	2	58	5	82	0	87	0	13	7	20	5	12	4	21	186
3:30 PM	3	42	0	45	4	65	0	69	0	13	5	18	3	7	6	16	148
3:45 PM	4	33	0	37	4	61	1	66	0	14	3	17	3	10	4	17	137
4:00 PM	4	23	0	27	4	49	2	55	0	17	1	18	2	7	4	13	113
4:15 PM	5	26	0	31	4	32	2	38	0	16	0	16	1	9	2	12	97
4:30 PM	4	26	0	30	2	28	2	32	0	16	0	16	1	13	0	14	92
4:45 PM	2	27	0	29	1	25	1	27	0	16	0	16	0	12	1	13	85
5:00 PM	1	23	0	24	0	30	0	30	0	13	0	13	0	14	2	16	83

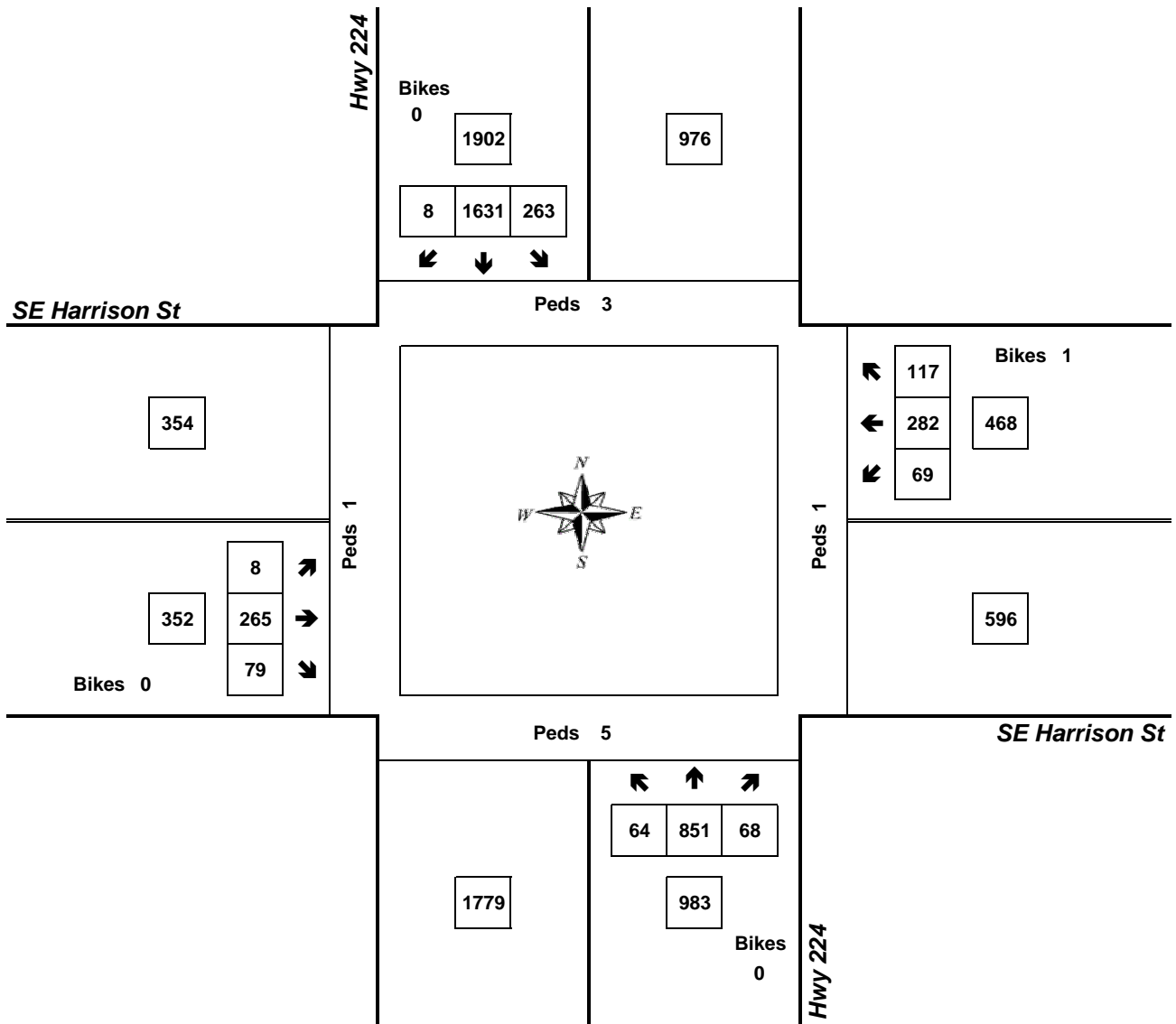
Peak Hour Summary



Clay Carney
(503) 833-2740

Hwy 224 & SE Harrison St

3:45 PM to 4:45 PM
Thursday, December 07, 2006



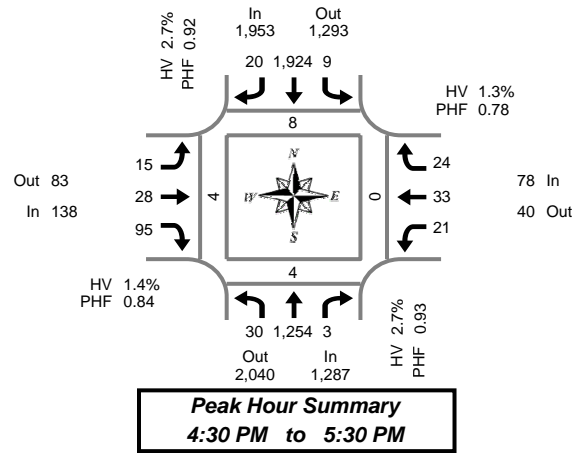
Approach	PHF	HV%	Volume
EB	0.87	4.8%	352
WB	0.92	3.6%	468
NB	0.86	3.8%	983
SB	0.91	3.5%	1,902
Intersection	0.95	3.7%	3,705

Count Period: 3:00 PM to 6:00 PM

Total Vehicle Summary



Clay Carney
(503) 833-2740



Hwy 224 & SE Monroe St

Tuesday, December 05, 2006
3:00 PM to 6:00 PM

15-Minute Interval Summary

3:00 PM to 6:00 PM

Interval Start Time	Northbound Hwy 224				Southbound Hwy 224				Eastbound SE Monroe St				Westbound SE Monroe St				Interval Total	Pedestrians Crosswalk			
	L	T	R	Bikes	L	T	R	Bikes	L	T	R	Bikes	L	T	R	Bikes		North	South	East	West
3:00 PM	4	221	0	0	3	367	3	0	4	3	16	0	5	5	9	0	640	0	0	0	0
3:15 PM	16	181	3	0	3	393	3	0	6	11	32	0	4	16	15	1	683	1	0	0	2
3:30 PM	7	234	5	0	3	382	5	0	2	13	30	0	12	12	19	0	724	0	1	0	0
3:45 PM	9	236	7	0	7	422	5	0	3	8	14	0	9	8	9	0	737	2	0	0	0
4:00 PM	8	296	3	0	2	469	2	0	3	8	12	1	4	6	7	0	820	1	1	0	1
4:15 PM	9	268	2	0	8	395	4	0	5	9	19	0	2	10	9	0	740	4	0	0	0
4:30 PM	9	281	2	0	3	451	3	0	1	4	26	0	7	10	8	2	805	4	1	0	0
4:45 PM	8	299	0	0	3	454	7	0	7	8	22	0	2	11	5	0	826	1	1	0	0
5:00 PM	8	334	0	0	2	492	5	0	5	11	25	1	8	7	4	0	901	3	1	0	0
5:15 PM	5	340	1	0	1	527	5	0	2	5	22	0	4	5	7	0	924	0	1	0	4
5:30 PM	7	268	1	0	1	454	3	0	3	9	18	0	6	6	10	0	786	2	0	0	3
5:45 PM	8	257	1	0	2	413	4	0	4	7	24	0	6	7	1	0	734	0	1	0	5
Total Survey	98	3,215	25	0	38	5,219	49	0	45	96	260	2	69	103	103	3	9,320	18	7	0	15

Peak Hour Summary

4:30 PM to 5:30 PM

By Approach	Northbound Hwy 224				Southbound Hwy 224				Eastbound SE Monroe St				Westbound SE Monroe St				Total	Pedestrians Crosswalk			
	In	Out	Total	Bikes	In	Out	Total	Bikes	In	Out	Total	Bikes	In	Out	Total	Bikes		North	South	East	West
Volume	1,287	2,040	3,327	0	1,953	1,293	3,246	0	138	83	221	1	78	40	118	2	3,456	8	4	0	4
%HV	2.7%				2.7%				1.4%				1.3%				2.6%				
PHF	0.93				0.92				0.84				0.78				0.94				

By Movement	Northbound Hwy 224				Southbound Hwy 224				Eastbound SE Monroe St				Westbound SE Monroe St				Total
	L	T	R	Total	L	T	R	Total	L	T	R	Total	L	T	R	Total	
Volume	30	1,254	3	1,287	9	1,924	20	1,953	15	28	95	138	21	33	24	78	3,456
%HV	0.0%	2.8%	0.0%	2.7%	11.1%	2.6%	5.0%	2.7%	0.0%	0.0%	2.1%	1.4%	0.0%	0.0%	4.2%	1.3%	2.6%
PHF	0.83	0.92	0.38	0.93	0.75	0.91	0.71	0.92	0.54	0.64	0.91	0.84	0.66	0.75	0.75	0.78	0.94

Rolling Hour Summary

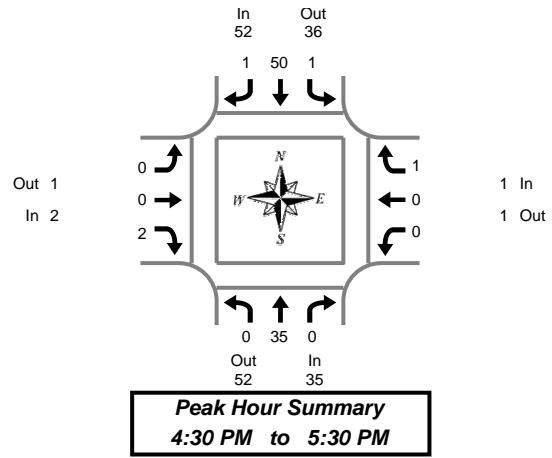
3:00 PM to 6:00 PM

Interval Start Time	Northbound Hwy 224				Southbound Hwy 224				Eastbound SE Monroe St				Westbound SE Monroe St				Interval Total	Pedestrians Crosswalk			
	L	T	R	Bikes	L	T	R	Bikes	L	T	R	Bikes	L	T	R	Bikes		North	South	East	West
3:00 PM	36	872	15	0	16	1,564	16	0	15	35	92	0	30	41	52	1	2,784	3	1	0	2
3:15 PM	40	947	18	0	15	1,666	15	0	14	40	88	1	29	42	50	1	2,964	4	2	0	3
3:30 PM	33	1,034	17	0	20	1,668	16	0	13	38	75	1	27	36	44	0	3,021	7	2	0	1
3:45 PM	35	1,081	14	0	20	1,737	14	0	12	29	71	1	22	34	33	2	3,102	11	2	0	1
4:00 PM	34	1,144	7	0	16	1,769	16	0	16	29	79	1	15	37	29	2	3,191	10	3	0	1
4:15 PM	34	1,182	4	0	16	1,792	19	0	18	32	92	1	19	38	26	2	3,272	12	3	0	0
4:30 PM	30	1,254	3	0	9	1,924	20	0	15	28	95	1	21	33	24	2	3,456	8	4	0	4
4:45 PM	28	1,241	2	0	7	1,927	20	0	17	33	87	1	20	29	26	0	3,437	6	3	0	7
5:00 PM	28	1,199	3	0	6	1,886	17	0	14	32	89	1	24	25	22	0	3,345	5	3	0	12

Heavy Vehicle Summary



Clay Carney
(503) 833-2740



Hwy 224 & SE Monroe St

Tuesday, December 05, 2006
3:00 PM to 6:00 PM

Heavy Vehicle 15-Minute Interval Summary 3:00 PM to 6:00 PM

Interval Start Time	Northbound Hwy 224				Southbound Hwy 224				Eastbound SE Monroe St				Westbound SE Monroe St				Interval Total
	L	T	R	Total	L	T	R	Total	L	T	R	Total	L	T	R	Total	
3:00 PM	0	13	0	13	0	21	0	21	0	0	0	0	1	0	0	1	35
3:15 PM	1	17	0	18	0	19	0	19	1	0	1	2	2	0	1	3	42
3:30 PM	0	16	0	16	1	20	1	22	0	0	1	1	0	0	1	1	40
3:45 PM	0	12	1	13	0	15	1	16	0	0	0	0	1	0	0	1	30
4:00 PM	0	17	0	17	0	24	0	24	0	0	0	0	0	0	1	1	42
4:15 PM	0	16	0	16	0	15	0	15	0	0	0	0	0	0	0	0	31
4:30 PM	0	15	0	15	0	12	0	12	0	0	1	1	0	0	1	1	29
4:45 PM	0	7	0	7	1	13	0	14	0	0	0	0	0	0	0	0	21
5:00 PM	0	5	0	5	0	12	1	13	0	0	1	1	0	0	0	0	19
5:15 PM	0	8	0	8	0	13	0	13	0	0	0	0	0	0	0	0	21
5:30 PM	0	7	0	7	0	6	0	6	0	0	0	0	0	0	0	0	13
5:45 PM	0	8	0	8	0	7	0	7	0	0	1	1	0	0	0	0	16
Total Survey	1	141	1	143	2	177	3	182	1	0	5	6	4	0	4	8	339

Heavy Vehicle Peak Hour Summary 4:30 PM to 5:30 PM

By Approach	Northbound Hwy 224			Southbound Hwy 224			Eastbound SE Monroe St			Westbound SE Monroe St			Total
	In	Out	Total	In	Out	Total	In	Out	Total	In	Out	Total	
Volume	35	52	87	52	36	88	2	1	3	1	1	2	90
PHF	0.18			0.21			0.17			0.05			0.19

By Movement	Northbound Hwy 224				Southbound Hwy 224				Eastbound SE Monroe St				Westbound SE Monroe St				Total
	L	T	R	Total	L	T	R	Total	L	T	R	Total	L	T	R	Total	
Volume	0	35	0	35	1	50	1	52	0	0	2	2	0	0	1	1	90
PHF	0.00	0.18	0.00	0.18	0.25	0.21	0.13	0.21	0.00	0.00	0.25	0.17	0.00	0.00	0.13	0.05	0.19

Heavy Vehicle Rolling Hour Summary 3:00 PM to 6:00 PM

Interval Start Time	Northbound Hwy 224				Southbound Hwy 224				Eastbound SE Monroe St				Westbound SE Monroe St				Interval Total
	L	T	R	Total	L	T	R	Total	L	T	R	Total	L	T	R	Total	
3:00 PM	1	58	1	60	1	75	2	78	1	0	2	3	4	0	2	6	147
3:15 PM	1	62	1	64	1	78	2	81	1	0	2	3	3	0	3	6	154
3:30 PM	0	61	1	62	1	74	2	77	0	0	1	1	1	0	2	3	143
3:45 PM	0	60	1	61	0	66	1	67	0	0	1	1	1	0	2	3	132
4:00 PM	0	55	0	55	1	64	0	65	0	0	1	1	0	0	2	2	123
4:15 PM	0	43	0	43	1	52	1	54	0	0	2	2	0	0	1	1	100
4:30 PM	0	35	0	35	1	50	1	52	0	0	2	2	0	0	1	1	90
4:45 PM	0	27	0	27	1	44	1	46	0	0	1	1	0	0	0	0	74
5:00 PM	0	28	0	28	0	38	1	39	0	0	2	2	0	0	0	0	69

Peak Hour Summary

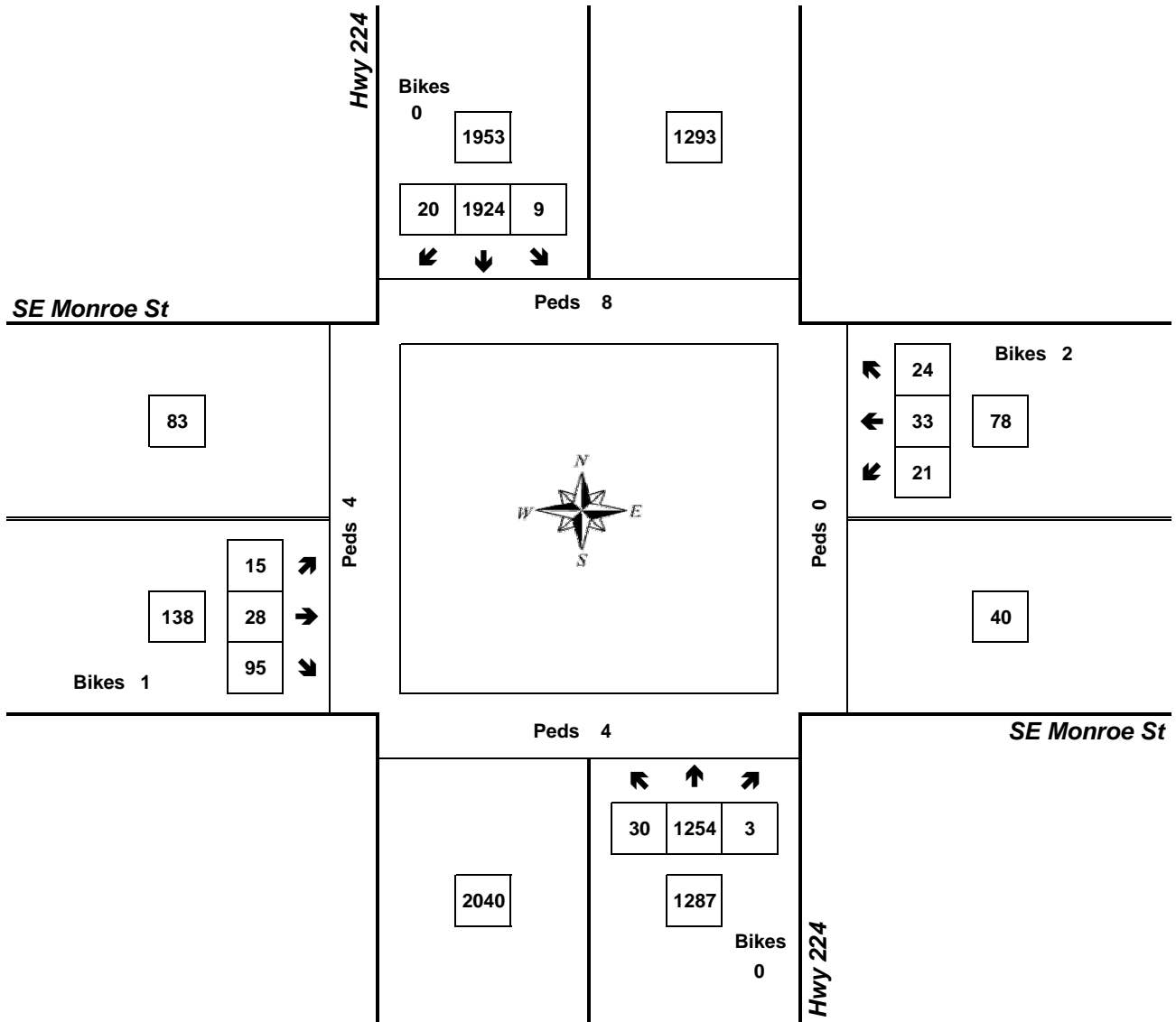


Clay Carney
(503) 833-2740

Hwy 224 & SE Monroe St

4:30 PM to 5:30 PM

Tuesday, December 05, 2006



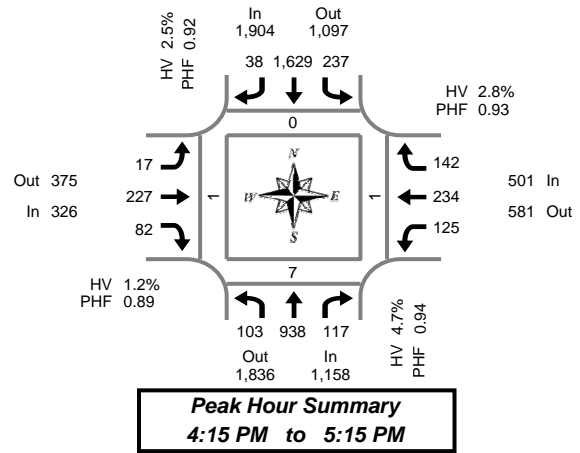
Approach	PHF	HV%	Volume
EB	0.84	1.4%	138
WB	0.78	1.3%	78
NB	0.93	2.7%	1,287
SB	0.92	2.7%	1,953
Intersection	0.94	2.6%	3,456

Count Period: 3:00 PM to 6:00 PM

Total Vehicle Summary



Clay Carney
(503) 833-2740



Hwy 224 & SE Oak St

Thursday, November 30, 2006
3:00 PM to 6:00 PM

15-Minute Interval Summary

3:00 PM to 6:00 PM

Interval Start Time	Northbound Hwy 224				Southbound Hwy 224				Eastbound SE Oak St				Westbound SE Oak St				Interval Total	Pedestrians Crosswalk			
	L	T	R	Bikes	L	T	R	Bikes	L	T	R	Bikes	L	T	R	Bikes		North	South	East	West
3:00 PM	25	197	39	0	39	317	12	0	1	37	18	1	26	72	27	0	810	0	0	2	0
3:15 PM	31	165	29	0	39	344	11	0	6	56	22	0	40	62	18	0	823	0	0	0	1
3:30 PM	25	210	29	0	54	306	6	0	2	89	22	0	32	82	32	0	889	0	2	0	1
3:45 PM	21	181	26	0	42	375	7	0	6	56	20	0	33	54	24	1	845	0	1	0	4
4:00 PM	24	228	42	0	51	442	5	0	1	55	22	0	32	48	18	0	968	0	4	1	1
4:15 PM	30	240	29	0	64	444	8	0	0	63	22	0	33	56	45	0	1,034	0	3	0	0
4:30 PM	32	215	30	0	60	360	11	0	7	50	21	0	34	50	41	0	911	0	0	1	1
4:45 PM	20	223	32	0	50	395	13	0	3	64	25	0	25	74	29	2	953	0	4	0	0
5:00 PM	21	260	26	0	63	430	6	0	7	50	14	0	33	54	27	1	991	0	0	0	0
5:15 PM	22	222	33	0	73	400	9	0	0	48	16	0	32	78	31	0	964	0	1	0	0
5:30 PM	22	231	37	0	55	416	10	0	4	60	17	0	22	63	22	0	959	0	0	0	0
5:45 PM	18	188	37	0	58	389	5	0	0	53	17	1	27	70	28	0	890	0	0	0	0
Total Survey	291	2,560	389	0	648	4,618	103	0	37	681	236	2	369	763	342	4	11,037	0	15	4	8

Peak Hour Summary

4:15 PM to 5:15 PM

By Approach	Northbound Hwy 224				Southbound Hwy 224				Eastbound SE Oak St				Westbound SE Oak St				Total	Pedestrians Crosswalk			
	In	Out	Total	Bikes	In	Out	Total	Bikes	In	Out	Total	Bikes	In	Out	Total	Bikes		North	South	East	West
Volume	1,158	1,836	2,994	0	1,904	1,097	3,001	0	326	375	701	0	501	581	1,082	3	3,889	0	7	1	1
%HV	4.7%				2.5%				1.2%				2.8%				3.1%				
PHF	0.94				0.92				0.89				0.93				0.94				

By Movement	Northbound Hwy 224				Southbound Hwy 224				Eastbound SE Oak St				Westbound SE Oak St				Total
	L	T	R	Total	L	T	R	Total	L	T	R	Total	L	T	R	Total	
Volume	103	938	117	1,158	237	1,629	38	1,904	17	227	82	326	125	234	142	501	3,889
%HV	2.9%	4.9%	5.1%	4.7%	0.4%	2.9%	0.0%	2.5%	5.9%	0.9%	1.2%	1.2%	6.4%	0.4%	3.5%	2.8%	3.1%
PHF	0.80	0.90	0.91	0.94	0.93	0.92	0.73	0.92	0.61	0.89	0.82	0.89	0.92	0.79	0.79	0.93	0.94

Rolling Hour Summary

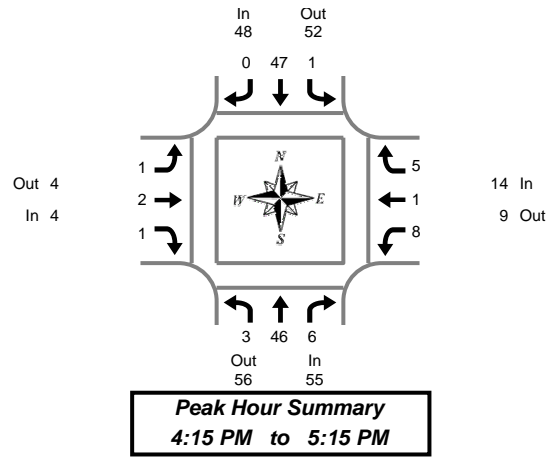
3:00 PM to 6:00 PM

Interval Start Time	Northbound Hwy 224				Southbound Hwy 224				Eastbound SE Oak St				Westbound SE Oak St				Interval Total	Pedestrians Crosswalk			
	L	T	R	Bikes	L	T	R	Bikes	L	T	R	Bikes	L	T	R	Bikes		North	South	East	West
3:00 PM	102	753	123	0	174	1,342	36	0	15	238	82	1	131	270	101	1	3,367	0	3	2	6
3:15 PM	101	784	126	0	186	1,467	29	0	15	256	86	0	137	246	92	1	3,525	0	7	1	7
3:30 PM	100	859	126	0	211	1,567	26	0	9	263	86	0	130	240	119	1	3,736	0	10	1	6
3:45 PM	107	864	127	0	217	1,621	31	0	14	224	85	0	132	208	128	1	3,758	0	8	2	6
4:00 PM	106	906	133	0	225	1,641	37	0	11	232	90	0	124	228	133	2	3,866	0	11	2	2
4:15 PM	103	938	117	0	237	1,629	38	0	17	227	82	0	125	234	142	3	3,889	0	7	1	1
4:30 PM	95	920	121	0	246	1,585	39	0	17	212	76	0	124	256	128	3	3,819	0	5	1	1
4:45 PM	85	936	128	0	241	1,641	38	0	14	222	72	0	112	269	109	3	3,867	0	5	0	0
5:00 PM	83	901	133	0	249	1,635	30	0	11	211	64	1	114	265	108	1	3,804	0	1	0	0

Heavy Vehicle Summary



Clay Carney
(503) 833-2740



Hwy 224 & SE Oak St

Thursday, November 30, 2006
3:00 PM to 6:00 PM

Heavy Vehicle 15-Minute Interval Summary 3:00 PM to 6:00 PM

Interval Start Time	Northbound Hwy 224				Southbound Hwy 224				Eastbound SE Oak St				Westbound SE Oak St				Interval Total	
	L	T	R	Total	L	T	R	Total	L	T	R	Total	L	T	R	Total		
3:00 PM	1	10	2	13	1	24	1	26	0	0	3	3	3	1	2	0	6	48
3:15 PM	2	14	0	16	0	25	0	25	0	0	0	0	2	2	0	4	45	
3:30 PM	2	14	0	16	2	19	0	21	0	2	0	2	2	1	2	5	44	
3:45 PM	2	15	0	17	0	15	0	15	0	0	0	0	1	2	0	3	35	
4:00 PM	0	4	2	6	4	22	0	26	0	8	0	8	1	2	0	3	43	
4:15 PM	2	9	4	15	0	10	0	10	0	1	1	2	4	0	2	6	33	
4:30 PM	1	14	0	15	0	12	0	12	0	0	0	0	2	0	3	5	32	
4:45 PM	0	15	1	16	1	15	0	16	0	1	0	1	1	0	0	1	34	
5:00 PM	0	8	1	9	0	10	0	10	1	0	0	1	1	1	0	2	22	
5:15 PM	0	8	0	8	1	11	0	12	0	0	0	0	1	0	1	2	22	
5:30 PM	0	6	0	6	0	7	1	8	0	0	0	0	0	0	0	0	14	
5:45 PM	0	6	0	6	0	12	0	12	0	0	0	0	0	0	0	0	18	
Total Survey	10	123	10	143	9	182	2	193	1	12	4	17	18	9	10	37	390	

Heavy Vehicle Peak Hour Summary 4:15 PM to 5:15 PM

By Approach	Northbound Hwy 224			Southbound Hwy 224			Eastbound SE Oak St			Westbound SE Oak St			Total
	In	Out	Total	In	Out	Total	In	Out	Total	In	Out	Total	
Volume	55	56	111	48	52	100	4	4	8	14	9	23	121
PHF	0.28			0.17			0.10			0.23			0.22

By Movement	Northbound Hwy 224				Southbound Hwy 224				Eastbound SE Oak St				Westbound SE Oak St				Total
	L	T	R	Total	L	T	R	Total	L	T	R	Total	L	T	R	Total	
Volume	3	46	6	55	1	47	0	48	1	2	1	4	8	1	5	14	121
PHF	0.13	0.27	0.25	0.28	0.04	0.17	0.00	0.17	0.25	0.05	0.08	0.10	0.29	0.05	0.25	0.23	0.22

Heavy Vehicle Rolling Hour Summary 3:00 PM to 6:00 PM

Interval Start Time	Northbound Hwy 224				Southbound Hwy 224				Eastbound SE Oak St				Westbound SE Oak St				Interval Total
	L	T	R	Total	L	T	R	Total	L	T	R	Total	L	T	R	Total	
3:00 PM	7	53	2	62	3	83	1	87	0	2	3	5	8	6	4	18	172
3:15 PM	6	47	2	55	6	81	0	87	0	10	0	10	6	7	2	15	167
3:30 PM	6	42	6	54	6	66	0	72	0	11	1	12	8	5	4	17	155
3:45 PM	5	42	6	53	4	59	0	63	0	9	1	10	8	4	5	17	143
4:00 PM	3	42	7	52	5	59	0	64	0	10	1	11	8	2	5	15	142
4:15 PM	3	46	6	55	1	47	0	48	1	2	1	4	8	1	5	14	121
4:30 PM	1	45	2	48	2	48	0	50	1	1	0	2	5	1	4	10	110
4:45 PM	0	37	2	39	2	43	1	46	1	1	0	2	3	1	1	5	92
5:00 PM	0	28	1	29	1	40	1	42	1	0	0	1	2	1	1	4	76

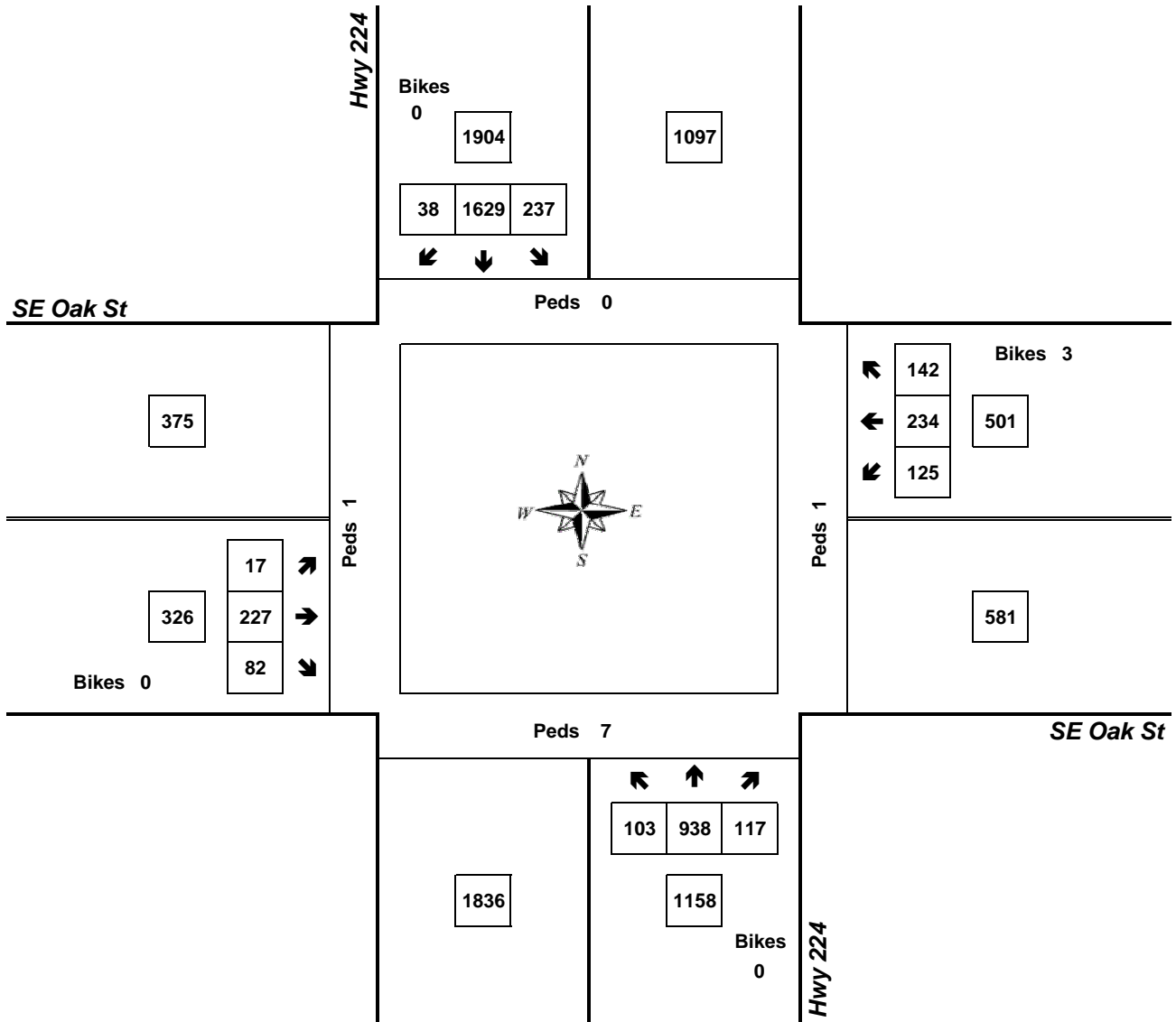
Peak Hour Summary



Clay Carney
(503) 833-2740

Hwy 224 & SE Oak St

4:15 PM to 5:15 PM
Thursday, November 30, 2006



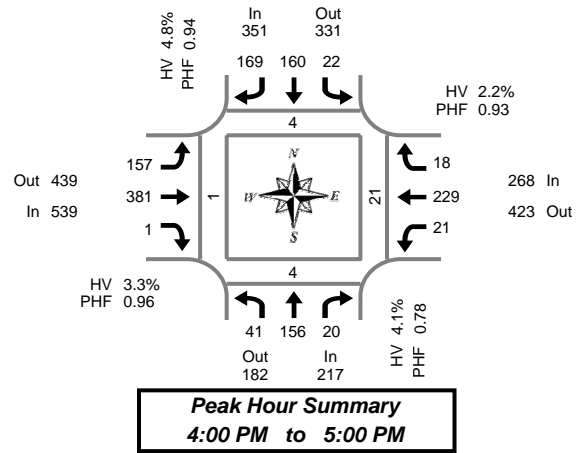
Approach	PHF	HV%	Volume
EB	0.89	1.2%	326
WB	0.93	2.8%	501
NB	0.94	4.7%	1,158
SB	0.92	2.5%	1,904
Intersection	0.94	3.1%	3,889

Count Period: 3:00 PM to 6:00 PM

Total Vehicle Summary



Clay Carney
(503) 833-2740



SE 32nd Ave & SE Harrison St

Thursday, December 07, 2006
3:00 PM to 6:00 PM

15-Minute Interval Summary 3:00 PM to 6:00 PM

Interval Start Time	Northbound SE 32nd Ave				Southbound SE 32nd Ave				Eastbound SE Harrison St				Westbound SE Harrison St				Interval Total	Pedestrians Crosswalk			
	L	T	R	Bikes	L	T	R	Bikes	L	T	R	Bikes	L	T	R	Bikes		North	South	East	West
3:00 PM	10	29	7	0	6	35	45	0	41	93	1	0	7	54	5	0	333	2	1	7	0
3:15 PM	11	47	8	0	9	47	46	0	43	79	2	0	4	55	5	0	356	6	6	4	0
3:30 PM	12	35	3	0	11	33	42	0	47	91	4	0	4	52	9	0	343	0	4	8	0
3:45 PM	4	42	5	0	6	55	45	0	37	56	0	0	4	44	6	0	304	5	2	12	1
4:00 PM	14	52	4	0	2	36	51	0	45	95	0	0	5	60	2	0	366	1	0	7	0
4:15 PM	11	38	6	0	8	40	36	0	39	97	0	0	4	57	2	0	338	0	1	3	0
4:30 PM	6	31	5	2	4	49	40	0	37	103	1	0	6	58	8	0	348	3	1	7	0
4:45 PM	10	35	5	0	8	35	42	0	36	86	0	0	6	54	6	0	323	0	2	4	1
5:00 PM	11	26	3	0	11	35	32	0	37	85	0	0	3	31	1	0	275	8	1	6	0
5:15 PM	16	52	4	0	7	36	46	0	28	95	1	0	7	39	6	0	337	4	2	7	2
5:30 PM	9	46	3	0	3	45	40	0	32	99	0	0	4	50	5	0	336	0	1	5	0
5:45 PM	11	33	4	0	6	32	35	0	24	100	1	0	7	49	5	0	307	1	1	1	0
Total Survey	125	466	57	2	81	478	500	0	446	1,079	10	0	61	603	60	0	3,966	30	22	71	4

Peak Hour Summary 4:00 PM to 5:00 PM

By Approach	Northbound SE 32nd Ave				Southbound SE 32nd Ave				Eastbound SE Harrison St				Westbound SE Harrison St				Total	Pedestrians Crosswalk			
	In	Out	Total	Bikes	In	Out	Total	Bikes	In	Out	Total	Bikes	In	Out	Total	Bikes		North	South	East	West
Volume	217	182	399	2	351	331	682	0	539	439	978	0	268	423	691	0	1,375	4	4	21	1
%HV	4.1%				4.8%				3.3%				2.2%				3.6%				
PHF	0.78				0.94				0.96				0.93				0.94				

By Movement	Northbound SE 32nd Ave				Southbound SE 32nd Ave				Eastbound SE Harrison St				Westbound SE Harrison St				Total
	L	T	R	Total	L	T	R	Total	L	T	R	Total	L	T	R	Total	
Volume	41	156	20	217	22	160	169	351	157	381	1	539	21	229	18	268	1,375
%HV	7.3%	3.8%	0.0%	4.1%	0.0%	5.6%	4.7%	4.8%	7.6%	1.6%	0.0%	3.3%	0.0%	2.2%	5.6%	2.2%	3.6%
PHF	0.73	0.75	0.83	0.78	0.69	0.82	0.83	0.94	0.87	0.92	0.25	0.96	0.88	0.95	0.56	0.93	0.94

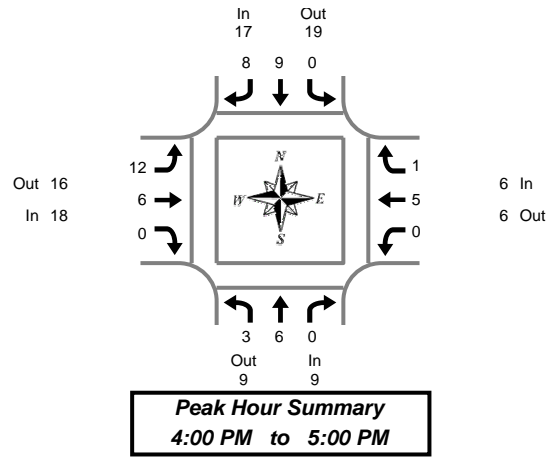
Rolling Hour Summary 3:00 PM to 6:00 PM

Interval Start Time	Northbound SE 32nd Ave				Southbound SE 32nd Ave				Eastbound SE Harrison St				Westbound SE Harrison St				Interval Total	Pedestrians Crosswalk			
	L	T	R	Bikes	L	T	R	Bikes	L	T	R	Bikes	L	T	R	Bikes		North	South	East	West
3:00 PM	37	153	23	0	32	170	178	0	168	319	7	0	19	205	25	0	1,336	13	13	31	1
3:15 PM	41	176	20	0	28	171	184	0	172	321	6	0	17	211	22	0	1,369	12	12	31	1
3:30 PM	41	167	18	0	27	164	174	0	168	339	4	0	17	213	19	0	1,351	6	7	30	1
3:45 PM	35	163	20	2	20	180	172	0	158	351	1	0	19	219	18	0	1,356	9	4	29	1
4:00 PM	41	156	20	2	22	160	169	0	157	381	1	0	21	229	18	0	1,375	4	4	21	1
4:15 PM	38	130	19	2	31	159	150	0	149	371	1	0	19	200	17	0	1,284	11	5	20	1
4:30 PM	43	144	17	2	30	155	160	0	138	369	2	0	22	182	21	0	1,283	15	6	24	3
4:45 PM	46	159	15	0	29	151	160	0	133	365	1	0	20	174	18	0	1,271	12	6	22	3
5:00 PM	47	157	14	0	27	148	153	0	121	379	2	0	21	169	17	0	1,255	13	5	19	2

Heavy Vehicle Summary



Clay Carney
(503) 833-2740



SE 32nd Ave & SE Harrison St

Thursday, December 07, 2006
3:00 PM to 6:00 PM

Heavy Vehicle 15-Minute Interval Summary 3:00 PM to 6:00 PM

Interval Start Time	Northbound SE 32nd Ave				Southbound SE 32nd Ave				Eastbound SE Harrison St				Westbound SE Harrison St				Interval Total
	L	T	R	Total	L	T	R	Total	L	T	R	Total	L	T	R	Total	
3:00 PM	0	1	1	2	1	1	4	6	3	4	0	7	0	3	0	3	18
3:15 PM	0	0	2	2	1	3	5	9	6	2	0	8	0	2	0	2	21
3:30 PM	0	1	0	1	0	0	2	2	5	4	0	9	0	1	1	2	14
3:45 PM	0	0	0	0	0	3	2	5	2	1	0	3	0	3	0	3	11
4:00 PM	0	3	0	3	0	3	1	4	3	1	0	4	0	1	1	2	13
4:15 PM	3	2	0	5	0	4	3	7	1	2	0	3	0	2	0	2	17
4:30 PM	0	0	0	0	0	1	4	5	3	2	0	5	0	1	0	1	11
4:45 PM	0	1	0	1	0	1	0	1	5	1	0	6	0	1	0	1	9
5:00 PM	0	1	0	1	0	0	2	2	2	1	0	3	0	1	0	1	7
5:15 PM	0	1	0	1	0	2	3	5	3	4	0	7	0	1	1	2	15
5:30 PM	0	0	0	0	0	0	3	3	3	2	0	5	0	2	0	2	10
5:45 PM	0	0	0	0	0	0	2	2	2	1	0	3	0	1	0	1	6
Total Survey	3	10	3	16	2	18	31	51	38	25	0	63	0	19	3	22	152

Heavy Vehicle Peak Hour Summary 4:00 PM to 5:00 PM

By Approach	Northbound SE 32nd Ave			Southbound SE 32nd Ave			Eastbound SE Harrison St			Westbound SE Harrison St			Total
	In	Out	Total	In	Out	Total	In	Out	Total	In	Out	Total	
Volume	9	9	18	17	19	36	18	16	34	6	6	12	50
PHF	0.28			0.25			0.19			0.21			0.24

By Movement	Northbound SE 32nd Ave				Southbound SE 32nd Ave				Eastbound SE Harrison St				Westbound SE Harrison St				Total
	L	T	R	Total	L	T	R	Total	L	T	R	Total	L	T	R	Total	
Volume	3	6	0	9	0	9	8	17	12	6	0	18	0	5	1	6	50
PHF	0.25	0.30	0.00	0.28	0.00	0.23	0.18	0.25	0.21	0.15	0.00	0.19	0.00	0.21	0.13	0.21	0.24

Heavy Vehicle Rolling Hour Summary 3:00 PM to 6:00 PM

Interval Start Time	Northbound SE 32nd Ave				Southbound SE 32nd Ave				Eastbound SE Harrison St				Westbound SE Harrison St				Interval Total
	L	T	R	Total	L	T	R	Total	L	T	R	Total	L	T	R	Total	
3:00 PM	0	2	3	5	2	7	13	22	16	11	0	27	0	9	1	10	64
3:15 PM	0	4	2	6	1	9	10	20	16	8	0	24	0	7	2	9	59
3:30 PM	3	6	0	9	0	10	8	18	11	8	0	19	0	7	2	9	55
3:45 PM	3	5	0	8	0	11	10	21	9	6	0	15	0	7	1	8	52
4:00 PM	3	6	0	9	0	9	8	17	12	6	0	18	0	5	1	6	50
4:15 PM	3	4	0	7	0	6	9	15	11	6	0	17	0	5	0	5	44
4:30 PM	0	3	0	3	0	4	9	13	13	8	0	21	0	4	1	5	42
4:45 PM	0	3	0	3	0	3	8	11	13	8	0	21	0	5	1	6	41
5:00 PM	0	2	0	2	0	2	10	12	10	8	0	18	0	5	1	6	38

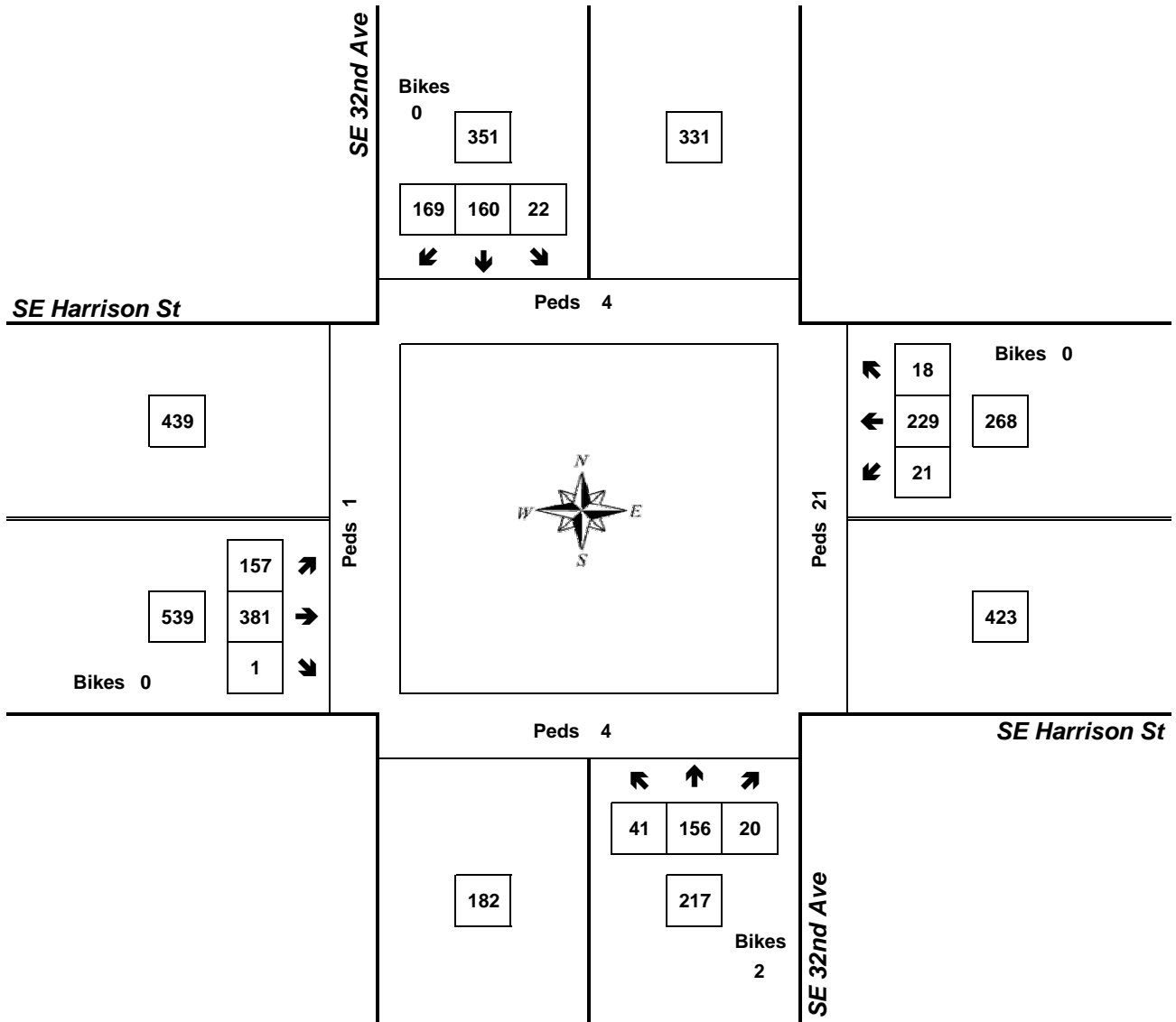
Peak Hour Summary



Clay Carney
(503) 833-2740

SE 32nd Ave & SE Harrison St

4:00 PM to 5:00 PM
Thursday, December 07, 2006



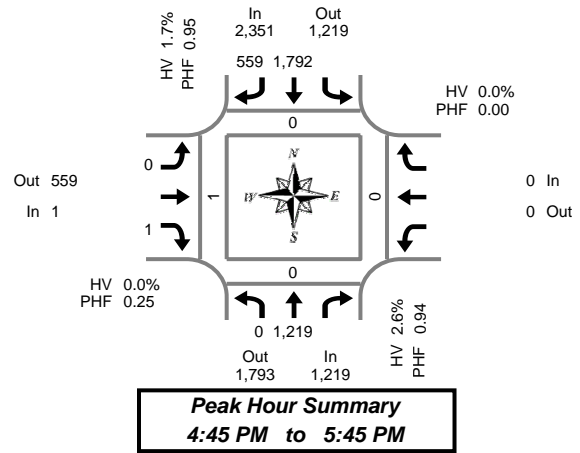
Approach	PHF	HV%	Volume
EB	0.96	3.3%	539
WB	0.93	2.2%	268
NB	0.78	4.1%	217
SB	0.94	4.8%	351
Intersection	0.94	3.6%	1,375

Count Period: 3:00 PM to 6:00 PM

Total Vehicle Summary



Clay Carney
(503) 833-2740



Hwy 99E & SE 22nd Ave

Tuesday, December 05, 2006
3:00 PM to 6:00 PM

15-Minute Interval Summary

3:00 PM to 6:00 PM

Interval Start Time	Northbound Hwy 99E			Southbound Hwy 99E			Eastbound SE 22nd Ave			Westbound SE 22nd Ave			Interval Total	Pedestrians Crosswalk			
	L	T	Bikes	T	R	Bikes	L	R	Bikes			Bikes		North	South	East	West
3:00 PM	0	296	0	337	75	0	0	0	0	0	0	0	708	0	0	0	0
3:15 PM	0	316	0	398	97	0	0	2	0	0	0	0	813	0	0	0	0
3:30 PM	0	316	0	415	104	0	0	0	0	0	0	0	835	0	0	0	0
3:45 PM	0	341	0	415	138	0	0	0	0	0	0	0	894	0	0	0	0
4:00 PM	0	299	0	490	110	1	0	2	0	0	0	0	901	0	0	0	0
4:15 PM	0	337	0	411	118	0	0	1	0	0	0	0	867	0	0	0	0
4:30 PM	0	284	0	471	149	0	0	0	0	0	0	0	904	0	0	0	0
4:45 PM	0	269	1	393	134	0	0	1	0	0	0	0	797	0	0	0	1
5:00 PM	0	308	0	463	154	0	0	0	0	0	0	0	925	0	0	0	0
5:15 PM	0	318	0	476	134	1	0	0	0	0	0	0	928	0	0	0	0
5:30 PM	0	324	0	460	137	0	0	0	0	0	0	0	921	0	0	0	0
5:45 PM	0	265	0	431	94	0	0	0	0	0	0	0	790	0	0	0	0
Total Survey	0	3,673	1	5,160	1,444	2	0	6	0	0	0	0	10,283	0	0	0	1

Peak Hour Summary

4:45 PM to 5:45 PM

By Approach	Northbound Hwy 99E				Southbound Hwy 99E				Eastbound SE 22nd Ave				Westbound SE 22nd Ave				Total	Pedestrians Crosswalk			
	In	Out	Total	Bikes	In	Out	Total	Bikes	In	Out	Total	Bikes	In	Out	Total	Bikes		North	South	East	West
Volume	1,219	1,793	3,012	1	2,351	1,219	3,570	1	1	559	560	0	0	0	0	0	0	0	0	1	
%HV	2.6%				1.7%				0.0%				0.0%				2.0%				
PHF	0.94				0.95				0.25				0.00				0.96				

By Movement	Northbound Hwy 99E			Southbound Hwy 99E			Eastbound SE 22nd Ave			Westbound SE 22nd Ave			Total
	L	T	Total	T	R	Total	L	R	Total			Total	
Volume	0	1,219	1,219	1,792	559	2,351	0	1	1			0	3,571
%HV	0.0%	2.6%	NA	2.1%	0.4%	1.7%	0.0%	NA	0.0%	0.0%	NA	NA	2.0%
PHF	0.00	0.94	0.94	0.94	0.91	0.95	0.00	0.25	0.25			0.00	0.96

Rolling Hour Summary

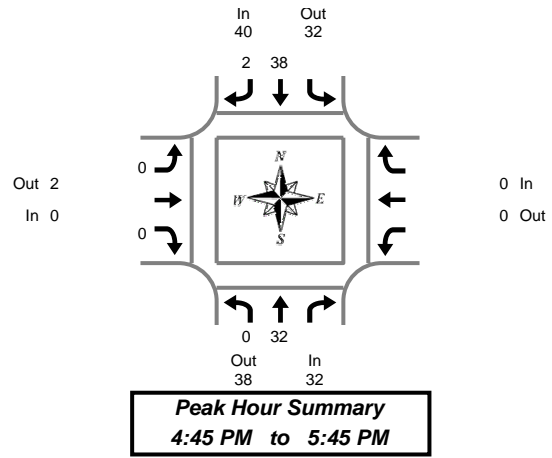
3:00 PM to 6:00 PM

Interval Start Time	Northbound Hwy 99E			Southbound Hwy 99E			Eastbound SE 22nd Ave			Westbound SE 22nd Ave			Interval Total	Pedestrians Crosswalk			
	L	T	Bikes	T	R	Bikes	L	R	Bikes			Bikes		North	South	East	West
3:00 PM	0	1,269	0	1,565	414	0	0	2	0	0	0	3,250	0	0	0	0	
3:15 PM	0	1,272	0	1,718	449	1	0	4	0	0	0	3,443	0	0	0	0	
3:30 PM	0	1,293	0	1,731	470	1	0	3	0	0	0	3,497	0	0	0	0	
3:45 PM	0	1,261	0	1,787	515	1	0	3	0	0	0	3,566	0	0	0	0	
4:00 PM	0	1,189	1	1,765	511	1	0	4	0	0	0	3,469	0	0	0	1	
4:15 PM	0	1,198	1	1,738	555	0	0	2	0	0	0	3,493	0	0	0	1	
4:30 PM	0	1,179	1	1,803	571	1	0	1	0	0	0	3,554	0	0	0	1	
4:45 PM	0	1,219	1	1,792	559	1	0	1	0	0	0	3,571	0	0	0	1	
5:00 PM	0	1,215	0	1,830	519	1	0	0	0	0	0	3,564	0	0	0	0	

Heavy Vehicle Summary



Clay Carney
(503) 833-2740



Hwy 99E & SE 22nd Ave

Tuesday, December 05, 2006
3:00 PM to 6:00 PM

Heavy Vehicle 15-Minute Interval Summary 3:00 PM to 6:00 PM

Interval Start Time	Northbound Hwy 99E			Southbound Hwy 99E			Eastbound SE 22nd Ave			Westbound SE 22nd Ave			Interval Total
	L	T	Total	T	R	Total	L	R	Total			Total	
3:00 PM	0	20	20	12	2	14	0	0	0			0	34
3:15 PM	0	12	12	14	0	14	0	0	0			0	26
3:30 PM	0	10	10	19	1	20	0	0	0			0	30
3:45 PM	0	13	13	14	0	14	0	0	0			0	27
4:00 PM	0	12	12	14	5	19	0	0	0			0	31
4:15 PM	0	14	14	9	0	9	0	0	0			0	23
4:30 PM	0	15	15	14	0	14	0	0	0			0	29
4:45 PM	0	5	5	11	0	11	0	0	0			0	16
5:00 PM	0	12	12	12	1	13	0	0	0			0	25
5:15 PM	0	9	9	7	1	8	0	0	0			0	17
5:30 PM	0	6	6	8	0	8	0	0	0			0	14
5:45 PM	0	6	6	7	0	7	0	0	0			0	13
Total Survey	0	134	134	141	10	151	0	0	0			0	285

Heavy Vehicle Peak Hour Summary 4:45 PM to 5:45 PM

By Approach	Northbound Hwy 99E			Southbound Hwy 99E			Eastbound SE 22nd Ave			Westbound SE 22nd Ave			Total
	In	Out	Total	In	Out	Total	In	Out	Total	In	Out	Total	
Volume	32	38	70	40	32	72	0	2	2	0	0	0	72
PHF	0.19			0.19			0.00			0.00			0.20

By Movement	Northbound Hwy 99E			Southbound Hwy 99E			Eastbound SE 22nd Ave			Westbound SE 22nd Ave			Total
	L	T	Total	T	R	Total	L	R	Total			Total	
Volume	0	32	32	38	2	40	0	0	0			0	72
PHF	0.00	0.19	0.19	0.20	0.08	0.19	0.00	0.00	0.00			0.00	0.20

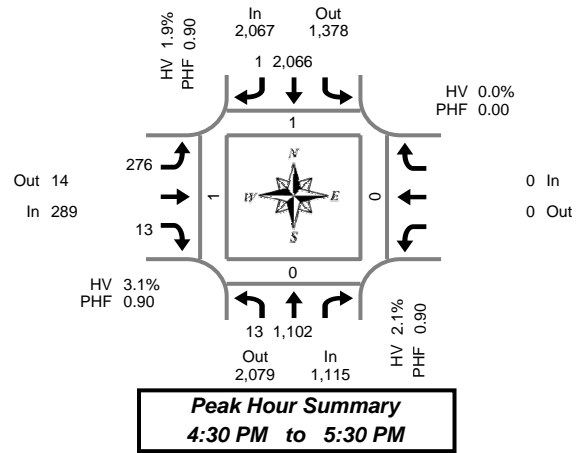
Heavy Vehicle Rolling Hour Summary 3:00 PM to 6:00 PM

Interval Start Time	Northbound Hwy 99E			Southbound Hwy 99E			Eastbound SE 22nd Ave			Westbound SE 22nd Ave			Interval Total
	L	T	Total	T	R	Total	L	R	Total			Total	
3:00 PM	0	55	55	59	3	62	0	0	0			0	117
3:15 PM	0	47	47	61	6	67	0	0	0			0	114
3:30 PM	0	49	49	56	6	62	0	0	0			0	111
3:45 PM	0	54	54	51	5	56	0	0	0			0	110
4:00 PM	0	46	46	48	5	53	0	0	0			0	99
4:15 PM	0	46	46	46	1	47	0	0	0			0	93
4:30 PM	0	41	41	44	2	46	0	0	0			0	87
4:45 PM	0	32	32	38	2	40	0	0	0			0	72
5:00 PM	0	33	33	34	2	36	0	0	0			0	69

Total Vehicle Summary



Clay Carney
(503) 833-2740



Hwy 99E & SE River Rd

Wednesday, December 06, 2006
3:00 PM to 6:00 PM

15-Minute Interval Summary

3:00 PM to 6:00 PM

Interval Start Time	Northbound Hwy 99E			Southbound Hwy 99E			Eastbound SE River Rd			Westbound SE River Rd			Interval Total	Pedestrians Crosswalk			
	L	T	Bikes	T	R	Bikes	L	R	Bikes			Bikes		North	South	East	West
3:00 PM	5	202	0	361	0	0	69	2	0			0	639	0	0	0	1
3:15 PM	5	262	0	371	0	0	61	4	0			0	703	0	1	0	0
3:30 PM	8	256	0	422	0	0	55	5	0			0	746	0	0	0	0
3:45 PM	4	288	0	457	0	0	74	3	0			0	826	0	0	0	1
4:00 PM	8	258	0	532	1	0	70	1	0			0	870	0	1	0	2
4:15 PM	1	249	0	508	1	0	59	15	0			0	833	2	0	0	3
4:30 PM	3	290	0	539	0	0	74	6	0			0	912	0	0	0	0
4:45 PM	3	271	0	462	0	0	64	1	0			0	801	1	0	0	1
5:00 PM	3	235	0	495	0	0	67	0	0			0	800	0	0	0	0
5:15 PM	4	306	0	570	1	0	71	6	0			0	958	0	0	0	0
5:30 PM	5	244	0	485	0	0	74	4	0			0	812	0	0	0	0
5:45 PM	6	271	0	517	0	0	60	2	0			0	856	0	0	0	2
Total Survey	55	3,132	0	5,719	3	0	798	49	0			0	9,756	3	2	0	10

Peak Hour Summary

4:30 PM to 5:30 PM

By Approach	Northbound Hwy 99E				Southbound Hwy 99E				Eastbound SE River Rd				Westbound SE River Rd				Total	Pedestrians Crosswalk			
	In	Out	Total	Bikes	In	Out	Total	Bikes	In	Out	Total	Bikes	In	Out	Total	Bikes		North	South	East	West
Volume	1,115	2,079	3,194	0	2,067	1,378	3,445	0	289	14	303	0	0	0	0	0	3,471	1	0	0	1
%HV	2.1%				1.9%				3.1%				0.0%				2.0%				
PHF	0.90				0.90				0.90				0.00				0.91				

By Movement	Northbound Hwy 99E			Southbound Hwy 99E			Eastbound SE River Rd			Westbound SE River Rd			Total	
	L	T	Total	T	R	Total	L	R	Total			Total		
Volume	13	1,102	1,115	2,066	1	2,067	276	13	289			0	3,471	
%HV	7.7%	2.0%	2.1%	NA	1.9%	0.0%	1.9%	3.3%	0.0%	3.1%	NA	NA	0.0%	2.0%
PHF	0.81	0.90	0.90	0.91	0.25	0.90	0.93	0.54	0.90			0.00	0.91	

Rolling Hour Summary

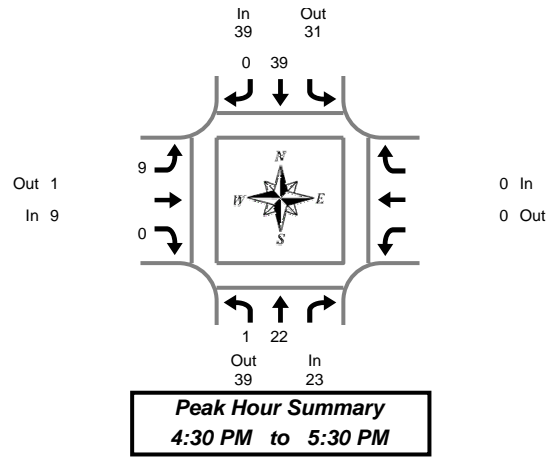
3:00 PM to 6:00 PM

Interval Start Time	Northbound Hwy 99E			Southbound Hwy 99E			Eastbound SE River Rd			Westbound SE River Rd			Interval Total	Pedestrians Crosswalk			
	L	T	Bikes	T	R	Bikes	L	R	Bikes			Bikes		North	South	East	West
3:00 PM	22	1,008	0	1,611	0	0	259	14	0			0	2,914	0	1	0	2
3:15 PM	25	1,064	0	1,782	1	0	260	13	0			0	3,145	0	2	0	3
3:30 PM	21	1,051	0	1,919	2	0	258	24	0			0	3,275	2	1	0	6
3:45 PM	16	1,085	0	2,036	2	0	277	25	0			0	3,441	2	1	0	6
4:00 PM	15	1,068	0	2,041	2	0	267	23	0			0	3,416	3	1	0	6
4:15 PM	10	1,045	0	2,004	1	0	264	22	0			0	3,346	3	0	0	4
4:30 PM	13	1,102	0	2,066	1	0	276	13	0			0	3,471	1	0	0	1
4:45 PM	15	1,056	0	2,012	1	0	276	11	0			0	3,371	1	0	0	1
5:00 PM	18	1,056	0	2,067	1	0	272	12	0			0	3,426	0	0	0	2

Heavy Vehicle Summary



Clay Carney
(503) 833-2740



Hwy 99E & SE River Rd

Wednesday, December 06, 2006
3:00 PM to 6:00 PM

Heavy Vehicle 15-Minute Interval Summary 3:00 PM to 6:00 PM

Interval Start Time	Northbound Hwy 99E			Southbound Hwy 99E			Eastbound SE River Rd			Westbound SE River Rd			Interval Total
	L	T	Total	T	R	Total	L	R	Total			Total	
3:00 PM	0	13	13	10	0	10	1	0	1			0	24
3:15 PM	0	17	17	14	0	14	1	0	1			0	32
3:30 PM	1	6	7	10	0	10	1	1	2			0	19
3:45 PM	1	15	16	12	0	12	0	0	0			0	28
4:00 PM	1	11	12	6	0	6	2	0	2			0	20
4:15 PM	0	11	11	8	0	8	4	1	5			0	24
4:30 PM	1	4	5	10	0	10	4	0	4			0	19
4:45 PM	0	10	10	11	0	11	3	0	3			0	24
5:00 PM	0	3	3	9	0	9	1	0	1			0	13
5:15 PM	0	5	5	9	0	9	1	0	1			0	15
5:30 PM	1	6	7	10	0	10	2	0	2			0	19
5:45 PM	0	7	7	6	0	6	1	0	1			0	14
Total Survey	5	108	113	115	0	115	21	2	23			0	251

Heavy Vehicle Peak Hour Summary 4:30 PM to 5:30 PM

By Approach	Northbound Hwy 99E			Southbound Hwy 99E			Eastbound SE River Rd			Westbound SE River Rd			Total
	In	Out	Total	In	Out	Total	In	Out	Total	In	Out	Total	
Volume	23	39	62	39	31	70	9	1	10	0	0	0	71
PHF	0.14			0.27			0.19			0.00			0.22

By Movement	Northbound Hwy 99E			Southbound Hwy 99E			Eastbound SE River Rd			Westbound SE River Rd			Total
	L	T	Total	T	R	Total	L	R	Total			Total	
Volume	1	22	23	39	0	39	9	0	9			0	71
PHF	0.08	0.14	0.14	0.27	0.00	0.27	0.20	0.00	0.19			0.00	0.22

Heavy Vehicle Rolling Hour Summary 3:00 PM to 6:00 PM

Interval Start Time	Northbound Hwy 99E			Southbound Hwy 99E			Eastbound SE River Rd			Westbound SE River Rd			Interval Total
	L	T	Total	T	R	Total	L	R	Total			Total	
3:00 PM	2	51	53	46	0	46	3	1	4			0	103
3:15 PM	3	49	52	42	0	42	4	1	5			0	99
3:30 PM	3	43	46	36	0	36	7	2	9			0	91
3:45 PM	3	41	44	36	0	36	10	1	11			0	91
4:00 PM	2	36	38	35	0	35	13	1	14			0	87
4:15 PM	1	28	29	38	0	38	12	1	13			0	80
4:30 PM	1	22	23	39	0	39	9	0	9			0	71
4:45 PM	1	24	25	39	0	39	7	0	7			0	71
5:00 PM	1	21	22	34	0	34	5	0	5			0	61

Peak Hour Summary

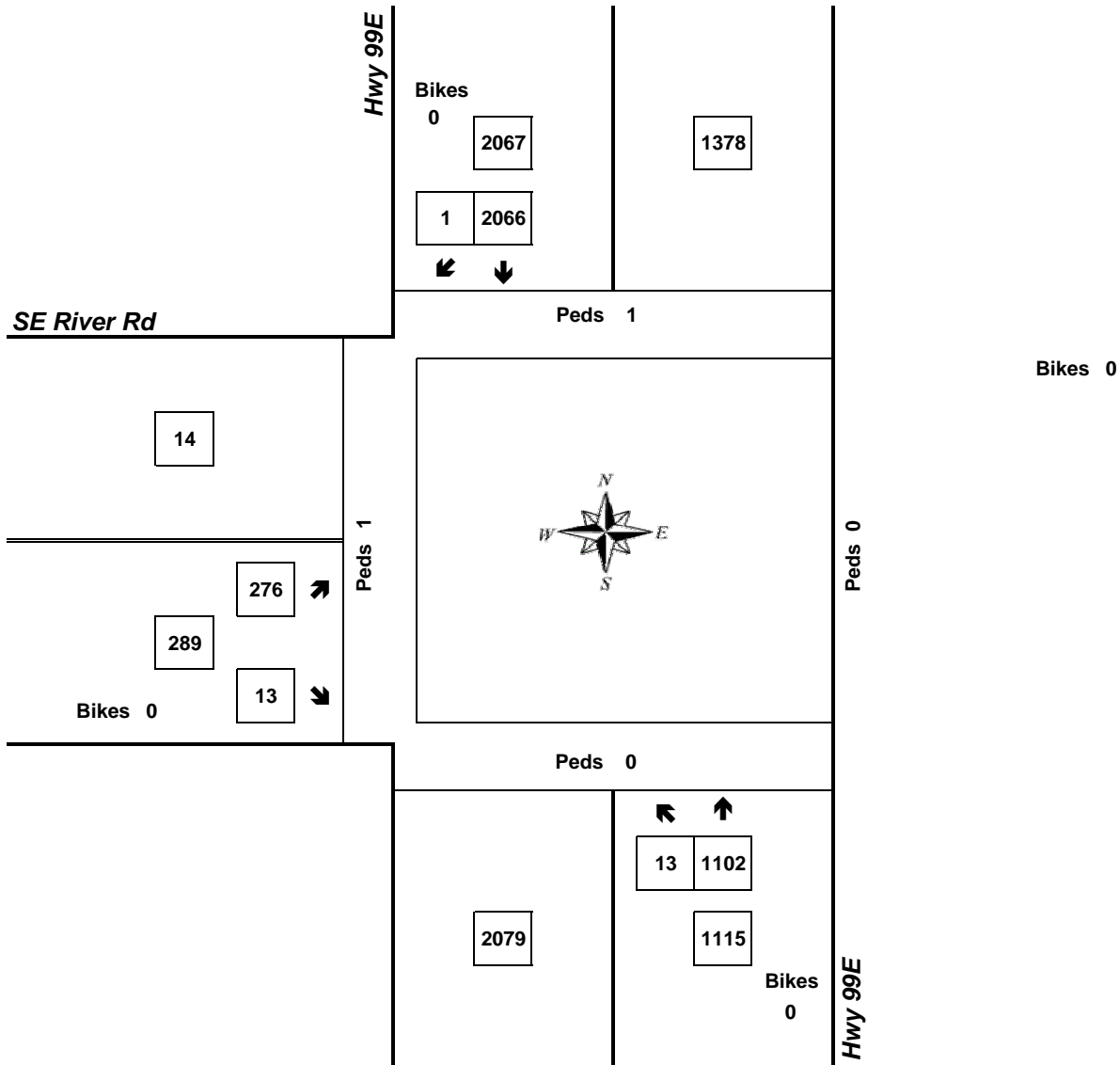


Clay Carney
(503) 833-2740

Hwy 99E & SE River Rd

4:30 PM to 5:30 PM

Wednesday, December 06, 2006



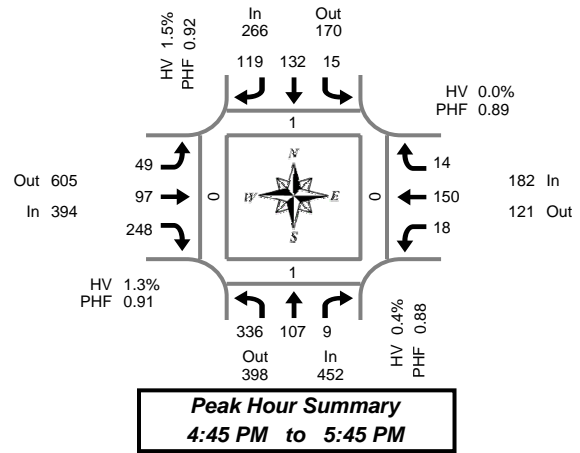
Approach	PHF	HV%	Volume
EB	0.90	3.1%	289
WB	0.00	0.0%	0
NB	0.90	2.1%	1,115
SB	0.90	1.9%	2,067
Intersection	0.91	2.0%	3,471

Count Period: 3:00 PM to 6:00 PM

Total Vehicle Summary



Clay Carney
(503) 833-2740



SE Lake Rd & SE Oatfield Rd

Tuesday, December 05, 2006
3:00 PM to 6:00 PM

15-Minute Interval Summary 3:00 PM to 6:00 PM

Interval Start Time	Northbound SE Lake Rd				Southbound SE Lake Rd				Eastbound SE Oatfield Rd				Westbound SE Oatfield Rd				Interval Total	Pedestrians Crosswalk			
	L	T	R	Bikes	L	T	R	Bikes	L	T	R	Bikes	L	T	R	Bikes		North	South	East	West
3:00 PM	62	29	2	0	3	31	11	0	14	20	53	0	2	28	1	0	256	0	1	1	0
3:15 PM	74	35	5	0	5	54	26	0	19	24	49	0	2	28	6	0	327	2	0	0	0
3:30 PM	66	24	5	0	7	53	35	0	7	25	60	0	10	18	1	0	311	8	1	2	0
3:45 PM	67	17	6	0	2	45	23	0	10	31	72	0	5	30	3	0	311	3	1	0	0
4:00 PM	71	36	8	0	2	32	27	0	10	27	62	0	6	35	5	0	321	2	9	0	12
4:15 PM	99	22	7	0	5	38	18	1	9	20	59	0	8	35	2	0	322	0	0	0	1
4:30 PM	95	24	4	0	7	27	18	0	9	27	55	0	6	36	2	0	310	0	4	0	0
4:45 PM	98	24	2	0	1	27	28	0	11	24	63	0	3	35	2	0	318	0	0	0	0
5:00 PM	102	25	2	0	5	25	37	0	5	26	53	0	2	44	5	0	331	0	1	0	0
5:15 PM	60	27	4	0	4	42	26	0	19	21	64	0	8	33	2	0	310	0	0	0	0
5:30 PM	76	31	1	0	5	38	28	0	14	26	68	0	5	38	5	0	335	1	0	0	0
5:45 PM	65	17	0	0	5	25	15	0	15	19	44	0	3	25	1	0	234	0	0	0	1
Total Survey	935	311	46	0	51	437	292	1	142	290	702	0	60	385	35	0	3,686	16	17	3	14

Peak Hour Summary 4:45 PM to 5:45 PM

By Approach	Northbound SE Lake Rd				Southbound SE Lake Rd				Eastbound SE Oatfield Rd				Westbound SE Oatfield Rd				Total	Pedestrians Crosswalk			
	In	Out	Total	Bikes	In	Out	Total	Bikes	In	Out	Total	Bikes	In	Out	Total	Bikes		North	South	East	West
Volume	452	398	850	0	266	170	436	0	394	605	999	0	182	121	303	0	1,294	1	1	0	0
%HV	0.4%				1.5%				1.3%				0.0%				0.9%				
PHF	0.88				0.92				0.91				0.89				0.97				

By Movement	Northbound SE Lake Rd				Southbound SE Lake Rd				Eastbound SE Oatfield Rd				Westbound SE Oatfield Rd				Total
	L	T	R	Total	L	T	R	Total	L	T	R	Total	L	T	R	Total	
Volume	336	107	9	452	15	132	119	266	49	97	248	394	18	150	14	182	1,294
%HV	0.0%	0.0%	22.2%	0.4%	6.7%	0.0%	2.5%	1.5%	4.1%	0.0%	1.2%	1.3%	0.0%	0.0%	0.0%	0.0%	0.9%
PHF	0.82	0.86	0.56	0.88	0.75	0.79	0.80	0.92	0.64	0.93	0.91	0.91	0.56	0.85	0.70	0.89	0.97

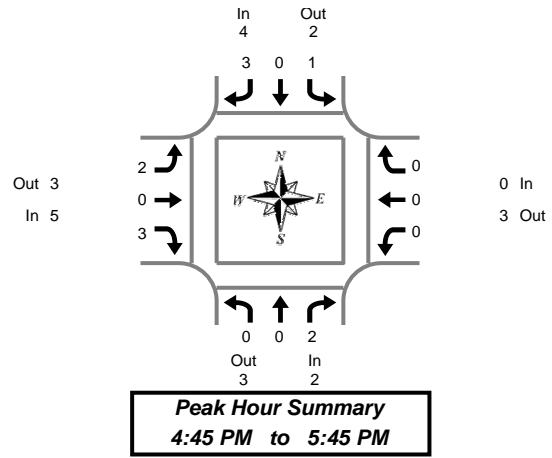
Rolling Hour Summary 3:00 PM to 6:00 PM

Interval Start Time	Northbound SE Lake Rd				Southbound SE Lake Rd				Eastbound SE Oatfield Rd				Westbound SE Oatfield Rd				Interval Total	Pedestrians Crosswalk			
	L	T	R	Bikes	L	T	R	Bikes	L	T	R	Bikes	L	T	R	Bikes		North	South	East	West
3:00 PM	269	105	18	0	17	183	95	0	50	100	234	0	19	104	11	0	1,205	13	3	3	0
3:15 PM	278	112	24	0	16	184	111	0	46	107	243	0	23	111	15	0	1,270	15	11	2	12
3:30 PM	303	99	26	0	16	168	103	1	36	103	253	0	29	118	11	0	1,265	13	11	2	13
3:45 PM	332	99	25	0	16	142	86	1	38	105	248	0	25	136	12	0	1,264	5	14	0	13
4:00 PM	363	106	21	0	15	124	91	1	39	98	239	0	23	141	11	0	1,271	2	13	0	13
4:15 PM	394	95	15	0	18	117	101	1	34	97	230	0	19	150	11	0	1,281	0	5	0	1
4:30 PM	355	100	12	0	17	121	109	0	44	98	235	0	19	148	11	0	1,269	0	5	0	0
4:45 PM	336	107	9	0	15	132	119	0	49	97	248	0	18	150	14	0	1,294	1	1	0	0
5:00 PM	303	100	7	0	19	130	106	0	53	92	229	0	18	140	13	0	1,210	1	1	0	1

Heavy Vehicle Summary



Clay Carney
(503) 833-2740



SE Lake Rd & SE Oatfield Rd

Tuesday, December 05, 2006
3:00 PM to 6:00 PM

Heavy Vehicle 15-Minute Interval Summary 3:00 PM to 6:00 PM

Interval Start Time	Northbound SE Lake Rd				Southbound SE Lake Rd				Eastbound SE Oatfield Rd				Westbound SE Oatfield Rd				Interval Total
	L	T	R	Total	L	T	R	Total	L	T	R	Total	L	T	R	Total	
3:00 PM	2	2	0	4	0	3	0	3	1	1	2	4	0	1	0	1	12
3:15 PM	1	4	1	6	0	3	0	3	3	0	1	4	0	2	0	2	15
3:30 PM	3	1	0	4	1	6	2	9	0	0	1	1	1	1	0	2	16
3:45 PM	2	1	0	3	0	0	0	0	1	1	5	7	1	0	0	1	11
4:00 PM	1	0	0	1	0	0	0	0	1	1	2	4	0	0	0	0	5
4:15 PM	0	0	2	2	0	0	1	1	1	1	1	3	1	1	0	2	8
4:30 PM	1	1	0	2	1	0	0	1	0	0	2	2	2	1	0	3	8
4:45 PM	0	0	0	0	0	0	1	1	1	0	1	2	0	0	0	0	3
5:00 PM	0	0	0	0	1	0	0	1	0	0	0	0	0	0	0	0	1
5:15 PM	0	0	2	2	0	0	1	1	1	0	2	3	0	0	0	0	6
5:30 PM	0	0	0	0	0	0	1	1	0	0	0	0	0	0	0	0	1
5:45 PM	0	0	0	0	0	0	0	0	1	0	1	2	0	0	0	0	2
Total Survey	10	9	5	24	3	12	6	21	10	4	18	32	5	6	0	11	88

Heavy Vehicle Peak Hour Summary 4:45 PM to 5:45 PM

By Approach	Northbound SE Lake Rd			Southbound SE Lake Rd			Eastbound SE Oatfield Rd			Westbound SE Oatfield Rd			Total
	In	Out	Total	In	Out	Total	In	Out	Total	In	Out	Total	
Volume	2	3	5	4	2	6	5	3	8	0	3	3	11
PHF	0.04			0.07			0.09			0.00			0.06

By Movement	Northbound SE Lake Rd				Southbound SE Lake Rd				Eastbound SE Oatfield Rd				Westbound SE Oatfield Rd				Total
	L	T	R	Total	L	T	R	Total	L	T	R	Total	L	T	R	Total	
Volume	0	0	2	2	1	0	3	4	2	0	3	5	0	0	0	0	11
PHF	0.00	0.00	0.25	0.04	0.13	0.00	0.38	0.07	0.13	0.00	0.09	0.09	0.00	0.00	0.00	0.00	0.06

Heavy Vehicle Rolling Hour Summary 3:00 PM to 6:00 PM

Interval Start Time	Northbound SE Lake Rd				Southbound SE Lake Rd				Eastbound SE Oatfield Rd				Westbound SE Oatfield Rd				Interval Total
	L	T	R	Total	L	T	R	Total	L	T	R	Total	L	T	R	Total	
3:00 PM	8	8	1	17	1	12	2	15	5	2	9	16	2	4	0	6	54
3:15 PM	7	6	1	14	1	9	2	12	5	2	9	16	2	3	0	5	47
3:30 PM	6	2	2	10	1	6	3	10	3	3	9	15	3	2	0	5	40
3:45 PM	4	2	2	8	1	0	1	2	3	3	10	16	4	2	0	6	32
4:00 PM	2	1	2	5	1	0	2	3	3	2	6	11	3	2	0	5	24
4:15 PM	1	1	2	4	2	0	2	4	2	1	4	7	3	2	0	5	20
4:30 PM	1	1	2	4	2	0	2	4	2	0	5	7	2	1	0	3	18
4:45 PM	0	0	2	2	1	0	3	4	2	0	3	5	0	0	0	0	11
5:00 PM	0	0	2	2	1	0	2	3	2	0	3	5	0	0	0	0	10

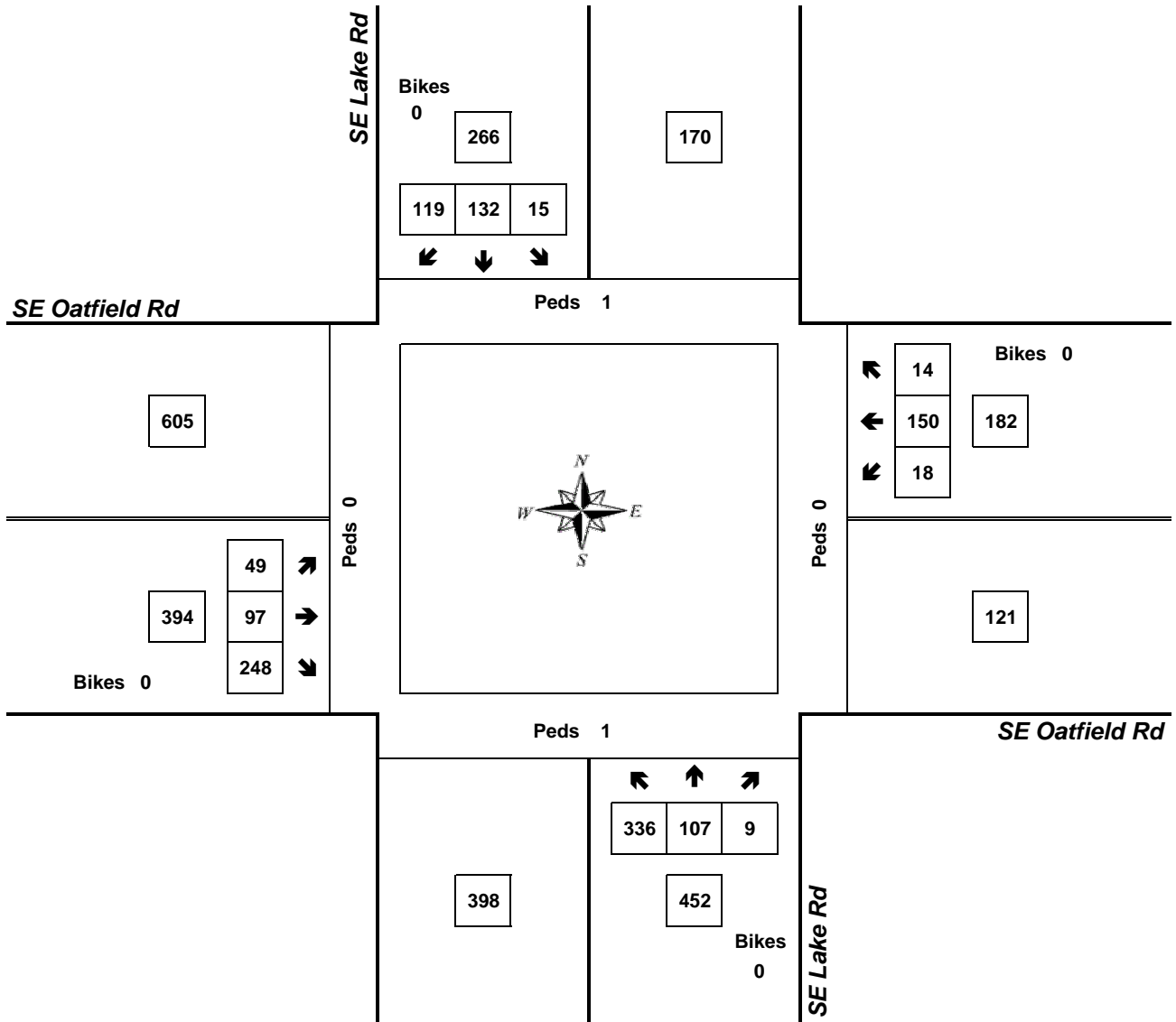
Peak Hour Summary



Clay Carney
(503) 833-2740

SE Lake Rd & SE Oatfield Rd

4:45 PM to 5:45 PM
Tuesday, December 05, 2006



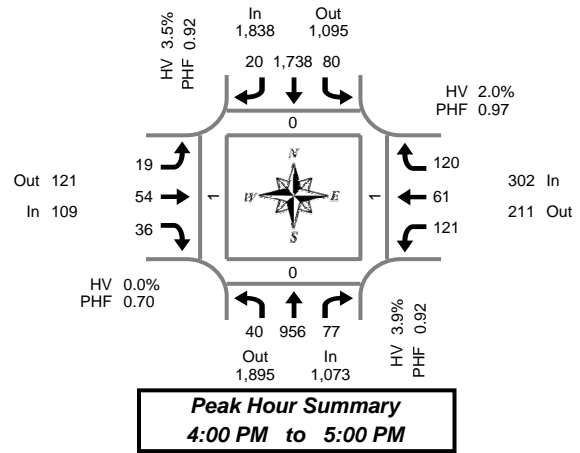
Approach	PHF	HV%	Volume
EB	0.91	1.3%	394
WB	0.89	0.0%	182
NB	0.88	0.4%	452
SB	0.92	1.5%	266
Intersection	0.97	0.9%	1,294

Count Period: 3:00 PM to 6:00 PM

Total Vehicle Summary



Clay Carney
(503) 833-2740



Hwy 224 & SE 37th Ave

Thursday, November 30, 2006
3:00 PM to 6:00 PM

15-Minute Interval Summary 3:00 PM to 6:00 PM

Interval Start Time	Northbound Hwy 224				Southbound Hwy 224				Eastbound SE 37th Ave				Westbound SE 37th Ave				Interval Total	Pedestrians Crosswalk			
	L	T	R	Bikes	L	T	R	Bikes	L	T	R	Bikes	L	T	R	Bikes		North	South	East	West
3:00 PM	10	228	17	0	14	338	1	0	3	10	13	0	29	8	21	0	692	0	0	0	0
3:15 PM	5	229	27	0	14	402	4	0	2	11	8	0	28	10	19	0	759	0	0	0	1
3:30 PM	8	235	26	0	12	331	0	0	1	20	13	0	45	9	25	0	725	0	0	0	0
3:45 PM	7	252	22	0	23	426	2	0	0	13	4	0	27	9	10	0	795	0	0	2	0
4:00 PM	12	252	17	0	18	448	7	0	2	25	12	0	25	20	32	0	870	0	0	0	1
4:15 PM	13	258	21	0	22	472	4	0	8	8	4	0	31	10	33	0	884	0	0	0	0
4:30 PM	8	201	20	0	21	398	4	0	3	13	13	0	35	15	28	0	759	0	0	0	0
4:45 PM	7	245	19	0	19	420	5	0	6	8	7	0	30	16	27	0	809	0	0	1	0
5:00 PM	5	234	22	0	23	453	1	0	3	12	2	0	31	21	45	0	852	0	0	0	0
5:15 PM	11	261	17	0	19	424	6	0	5	10	5	0	29	12	23	0	822	0	0	0	1
5:30 PM	9	249	21	0	15	406	3	0	5	3	7	0	36	18	32	0	804	0	0	0	0
5:45 PM	9	202	19	0	17	427	2	0	0	11	4	0	21	17	18	0	747	0	0	0	0
Total Survey	104	2,846	248	0	217	4,945	39	0	38	144	92	0	367	165	313	0	9,518	0	0	3	3

Peak Hour Summary 4:00 PM to 5:00 PM

By Approach	Northbound Hwy 224				Southbound Hwy 224				Eastbound SE 37th Ave				Westbound SE 37th Ave				Total	Pedestrians Crosswalk			
	In	Out	Total	Bikes	In	Out	Total	Bikes	In	Out	Total	Bikes	In	Out	Total	Bikes		North	South	East	West
Volume	1,073	1,895	2,968	0	1,838	1,095	2,933	0	109	121	230	0	302	211	513	0	3,322	0	0	1	1
%HV	3.9%				3.5%				0.0%				2.0%				3.4%				
PHF	0.92				0.92				0.70				0.97				0.94				

By Movement	Northbound Hwy 224				Southbound Hwy 224				Eastbound SE 37th Ave				Westbound SE 37th Ave				Total
	L	T	R	Total	L	T	R	Total	L	T	R	Total	L	T	R	Total	
Volume	40	956	77	1,073	80	1,738	20	1,838	19	54	36	109	121	61	120	302	3,322
%HV	0.0%	4.3%	1.3%	3.9%	1.3%	3.7%	0.0%	3.5%	0.0%	0.0%	0.0%	0.0%	0.8%	1.6%	3.3%	2.0%	3.4%
PHF	0.77	0.93	0.92	0.92	0.91	0.92	0.71	0.92	0.59	0.54	0.69	0.70	0.86	0.76	0.91	0.97	0.94

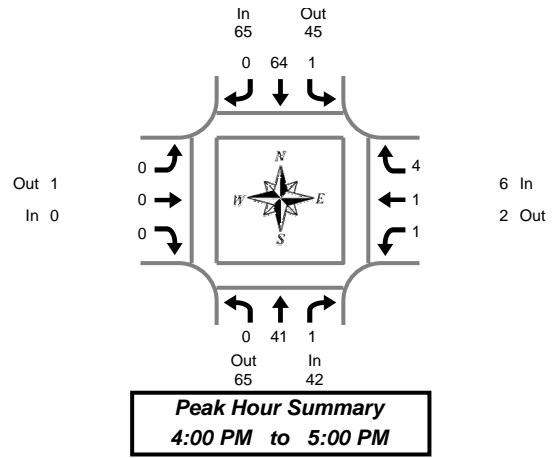
Rolling Hour Summary 3:00 PM to 6:00 PM

Interval Start Time	Northbound Hwy 224				Southbound Hwy 224				Eastbound SE 37th Ave				Westbound SE 37th Ave				Interval Total	Pedestrians Crosswalk			
	L	T	R	Bikes	L	T	R	Bikes	L	T	R	Bikes	L	T	R	Bikes		North	South	East	West
3:00 PM	30	944	92	0	63	1,497	7	0	6	54	38	0	129	36	75	0	2,971	0	0	2	1
3:15 PM	32	968	92	0	67	1,607	13	0	5	69	37	0	125	48	86	0	3,149	0	0	2	2
3:30 PM	40	997	86	0	75	1,677	13	0	11	66	33	0	128	48	100	0	3,274	0	0	2	1
3:45 PM	40	963	80	0	84	1,744	17	0	13	59	33	0	118	54	103	0	3,308	0	0	2	1
4:00 PM	40	956	77	0	80	1,738	20	0	19	54	36	0	121	61	120	0	3,322	0	0	1	1
4:15 PM	33	938	82	0	85	1,743	14	0	20	41	26	0	127	62	133	0	3,304	0	0	1	0
4:30 PM	31	941	78	0	82	1,695	16	0	17	43	27	0	125	64	123	0	3,242	0	0	1	1
4:45 PM	32	989	79	0	76	1,703	15	0	19	33	21	0	126	67	127	0	3,287	0	0	1	1
5:00 PM	34	946	79	0	74	1,710	12	0	13	36	18	0	117	68	118	0	3,225	0	0	0	1

Heavy Vehicle Summary



Clay Carney
(503) 833-2740



Hwy 224 & SE 37th Ave

Thursday, November 30, 2006
3:00 PM to 6:00 PM

Heavy Vehicle 15-Minute Interval Summary 3:00 PM to 6:00 PM

Interval Start Time	Northbound Hwy 224				Southbound Hwy 224				Eastbound SE 37th Ave				Westbound SE 37th Ave				Interval Total
	L	T	R	Total	L	T	R	Total	L	T	R	Total	L	T	R	Total	
3:00 PM	0	12	1	13	3	19	0	22	0	0	0	0	0	0	1	1	36
3:15 PM	0	21	0	21	2	25	0	27	0	0	0	0	1	0	1	2	50
3:30 PM	0	16	2	18	3	18	0	21	0	0	1	1	1	0	1	2	42
3:45 PM	0	14	1	15	3	18	0	21	0	1	0	1	3	0	0	3	40
4:00 PM	0	8	0	8	1	23	0	24	0	0	0	0	0	0	0	0	32
4:15 PM	0	12	0	12	0	18	0	18	0	0	0	0	1	0	2	3	33
4:30 PM	0	11	1	12	0	14	0	14	0	0	0	0	0	1	1	2	28
4:45 PM	0	10	0	10	0	9	0	9	0	0	0	0	0	0	1	1	20
5:00 PM	0	11	0	11	1	12	0	13	0	0	0	0	0	0	0	0	24
5:15 PM	0	12	0	12	0	11	1	12	0	0	0	0	0	0	0	0	24
5:30 PM	0	5	0	5	0	7	0	7	0	0	0	0	0	0	0	0	12
5:45 PM	0	6	0	6	0	14	0	14	0	0	0	0	0	0	0	0	20
Total Survey	0	138	5	143	13	188	1	202	0	1	1	2	6	1	7	14	361

Heavy Vehicle Peak Hour Summary 4:00 PM to 5:00 PM

By Approach	Northbound Hwy 224			Southbound Hwy 224			Eastbound SE 37th Ave			Westbound SE 37th Ave			Total
	In	Out	Total	In	Out	Total	In	Out	Total	In	Out	Total	
Volume	42	65	107	65	45	110	0	1	1	6	2	8	113
PHF	0.19			0.23			0.00			0.21			0.21

By Movement	Northbound Hwy 224				Southbound Hwy 224				Eastbound SE 37th Ave				Westbound SE 37th Ave				Total
	L	T	R	Total	L	T	R	Total	L	T	R	Total	L	T	R	Total	
Volume	0	41	1	42	1	64	0	65	0	0	0	0	1	1	4	6	113
PHF	0.00	0.20	0.08	0.19	0.03	0.26	0.00	0.23	0.00	0.00	0.00	0.00	0.05	0.25	0.25	0.21	0.21

Heavy Vehicle Rolling Hour Summary 3:00 PM to 6:00 PM

Interval Start Time	Northbound Hwy 224				Southbound Hwy 224				Eastbound SE 37th Ave				Westbound SE 37th Ave				Interval Total
	L	T	R	Total	L	T	R	Total	L	T	R	Total	L	T	R	Total	
3:00 PM	0	63	4	67	11	80	0	91	0	1	1	2	5	0	3	8	168
3:15 PM	0	59	3	62	9	84	0	93	0	1	1	2	5	0	2	7	164
3:30 PM	0	50	3	53	7	77	0	84	0	1	1	2	5	0	3	8	147
3:45 PM	0	45	2	47	4	73	0	77	0	1	0	1	4	1	3	8	133
4:00 PM	0	41	1	42	1	64	0	65	0	0	0	0	1	1	4	6	113
4:15 PM	0	44	1	45	1	53	0	54	0	0	0	0	1	1	4	6	105
4:30 PM	0	44	1	45	1	46	1	48	0	0	0	0	0	1	2	3	96
4:45 PM	0	38	0	38	1	39	1	41	0	0	0	0	0	0	1	1	80
5:00 PM	0	34	0	34	1	44	1	46	0	0	0	0	0	0	0	0	80

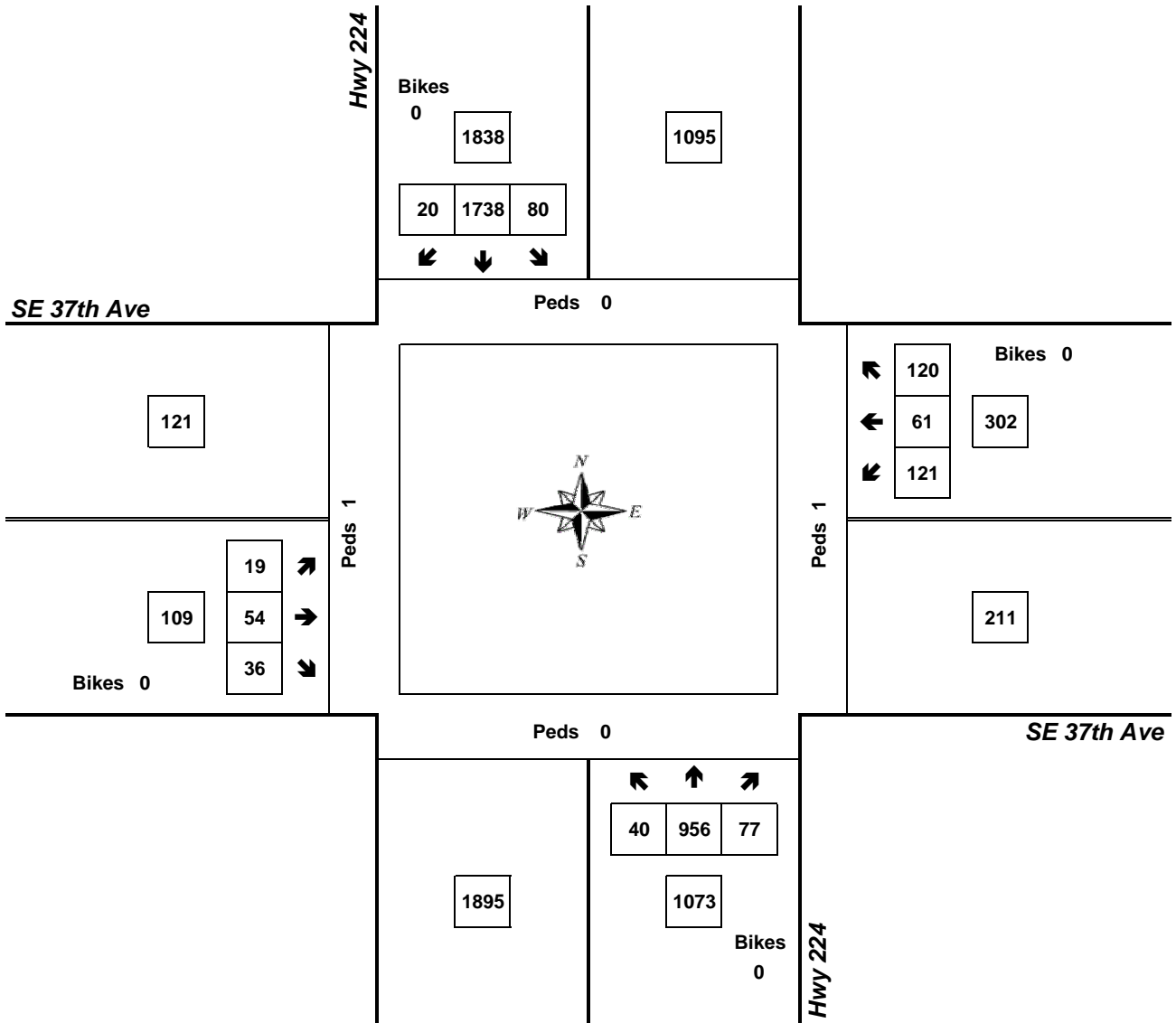
Peak Hour Summary



Clay Carney
(503) 833-2740

Hwy 224 & SE 37th Ave

4:00 PM to 5:00 PM
Thursday, November 30, 2006



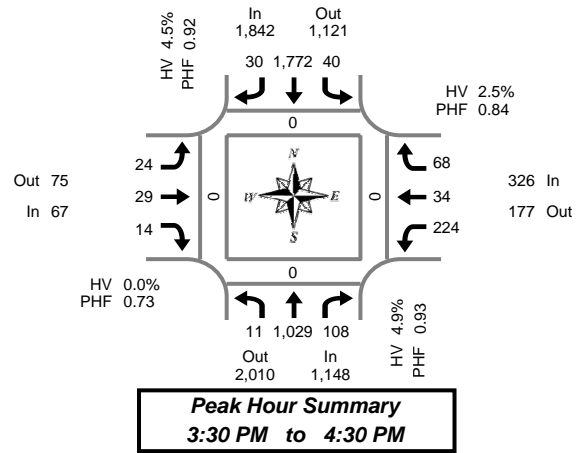
Approach	PHF	HV%	Volume
EB	0.70	0.0%	109
WB	0.97	2.0%	302
NB	0.92	3.9%	1,073
SB	0.92	3.5%	1,838
Intersection	0.94	3.4%	3,322

Count Period: 3:00 PM to 6:00 PM

Total Vehicle Summary



Clay Carney
(503) 833-2740



Hwy 224 & SE Freeman Way

Thursday, November 30, 2006
3:00 PM to 6:00 PM

15-Minute Interval Summary 3:00 PM to 6:00 PM

Interval Start Time	Northbound Hwy 224				Southbound Hwy 224				Eastbound SE Freeman Way				Westbound SE Freeman Way				Interval Total	Pedestrians Crosswalk			
	L	T	R	Bikes	L	T	R	Bikes	L	T	R	Bikes	L	T	R	Bikes		North	South	East	West
3:00 PM	1	269	20	0	8	389	7	0	2	2	4	0	41	6	11	0	760	0	0	0	0
3:15 PM	2	244	19	0	16	387	7	0	5	7	1	0	33	13	17	0	751	0	0	0	0
3:30 PM	0	248	42	0	14	385	2	0	3	10	3	0	55	5	13	0	780	0	0	0	0
3:45 PM	3	266	24	0	12	426	11	0	6	13	4	0	38	5	16	0	824	0	0	0	0
4:00 PM	3	226	27	0	7	473	10	0	5	5	2	0	68	7	22	0	855	0	0	0	0
4:15 PM	5	289	15	0	7	488	7	0	10	1	5	0	63	17	17	0	924	0	0	0	0
4:30 PM	10	188	23	0	8	428	13	0	2	4	1	0	54	10	20	0	761	0	0	0	0
4:45 PM	2	262	21	0	10	444	8	0	1	5	3	0	46	10	23	0	835	0	0	0	0
5:00 PM	4	256	15	0	7	443	7	0	1	3	1	0	69	9	16	0	831	0	0	0	0
5:15 PM	13	239	16	0	2	403	12	0	7	3	1	0	63	15	20	0	794	0	0	0	0
5:30 PM	4	283	14	0	8	448	7	0	6	0	1	0	57	8	9	0	845	0	0	0	0
5:45 PM	2	205	14	0	5	422	10	0	6	2	2	0	40	9	9	0	726	0	0	0	0
Total Survey	49	2,975	250	0	104	5,136	101	0	54	55	28	0	627	114	193	0	9,686	0	0	0	0

Peak Hour Summary 3:30 PM to 4:30 PM

By Approach	Northbound Hwy 224				Southbound Hwy 224				Eastbound SE Freeman Way				Westbound SE Freeman Way				Total	Pedestrians Crosswalk			
	In	Out	Total	Bikes	In	Out	Total	Bikes	In	Out	Total	Bikes	In	Out	Total	Bikes		North	South	East	West
Volume	1,148	2,010	3,158	0	1,842	1,121	2,963	0	67	75	142	0	326	177	503	0	3,383	0	0	0	0
%HV	4.9%				4.5%				0.0%				2.5%				4.3%				
PHF	0.93				0.92				0.73				0.84				0.92				

By Movement	Northbound Hwy 224				Southbound Hwy 224				Eastbound SE Freeman Way				Westbound SE Freeman Way				Total
	L	T	R	Total	L	T	R	Total	L	T	R	Total	L	T	R	Total	
Volume	11	1,029	108	1,148	40	1,772	30	1,842	24	29	14	67	224	34	68	326	3,383
%HV	9.1%	5.1%	2.8%	4.9%	2.5%	4.6%	0.0%	4.5%	0.0%	0.0%	0.0%	0.0%	2.2%	0.0%	4.4%	2.5%	4.3%
PHF	0.55	0.89	0.64	0.93	0.71	0.91	0.68	0.92	0.60	0.56	0.70	0.73	0.82	0.50	0.77	0.84	0.92

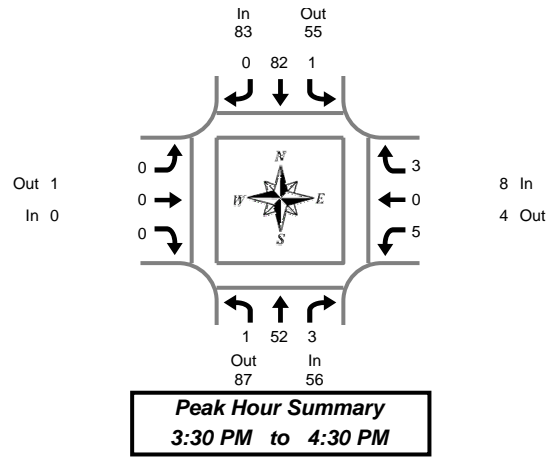
Rolling Hour Summary 3:00 PM to 6:00 PM

Interval Start Time	Northbound Hwy 224				Southbound Hwy 224				Eastbound SE Freeman Way				Westbound SE Freeman Way				Interval Total	Pedestrians Crosswalk			
	L	T	R	Bikes	L	T	R	Bikes	L	T	R	Bikes	L	T	R	Bikes		North	South	East	West
3:00 PM	6	1,027	105	0	50	1,587	27	0	16	32	12	0	167	29	57	0	3,115	0	0	0	0
3:15 PM	8	984	112	0	49	1,671	30	0	19	35	10	0	194	30	68	0	3,210	0	0	0	0
3:30 PM	11	1,029	108	0	40	1,772	30	0	24	29	14	0	224	34	68	0	3,383	0	0	0	0
3:45 PM	21	969	89	0	34	1,815	41	0	23	23	12	0	223	39	75	0	3,364	0	0	0	0
4:00 PM	20	965	86	0	32	1,833	38	0	18	15	11	0	231	44	82	0	3,375	0	0	0	0
4:15 PM	21	995	74	0	32	1,803	35	0	14	13	10	0	232	46	76	0	3,351	0	0	0	0
4:30 PM	29	945	75	0	27	1,718	40	0	11	15	6	0	232	44	79	0	3,221	0	0	0	0
4:45 PM	23	1,040	66	0	27	1,738	34	0	15	11	6	0	235	42	68	0	3,305	0	0	0	0
5:00 PM	23	983	59	0	22	1,716	36	0	20	8	5	0	229	41	54	0	3,196	0	0	0	0

Heavy Vehicle Summary



Clay Carney
(503) 833-2740



Hwy 224 & SE Freeman Way

Thursday, November 30, 2006
3:00 PM to 6:00 PM

Heavy Vehicle 15-Minute Interval Summary 3:00 PM to 6:00 PM

Interval Start Time	Northbound Hwy 224				Southbound Hwy 224				Eastbound SE Freeman Way				Westbound SE Freeman Way				Interval Total
	L	T	R	Total	L	T	R	Total	L	T	R	Total	L	T	R	Total	
3:00 PM	0	13	0	13	0	29	0	29	0	0	0	0	2	0	3	5	47
3:15 PM	0	15	2	17	3	24	0	27	0	0	0	0	2	0	4	6	50
3:30 PM	0	20	1	21	0	20	0	20	0	0	0	0	2	0	1	3	44
3:45 PM	0	12	0	12	1	18	0	19	0	0	0	0	0	0	2	2	33
4:00 PM	0	9	1	10	0	23	0	23	0	0	0	0	1	0	0	1	34
4:15 PM	1	11	1	13	0	21	0	21	0	0	0	0	2	0	0	2	36
4:30 PM	0	9	2	11	0	13	0	13	0	0	0	0	0	0	2	2	26
4:45 PM	0	10	0	10	0	9	0	9	0	0	0	0	1	0	0	1	20
5:00 PM	0	11	1	12	1	9	0	10	0	0	0	0	0	0	0	0	22
5:15 PM	0	7	0	7	0	12	0	12	0	0	0	0	1	0	1	2	21
5:30 PM	0	6	0	6	0	6	0	6	0	0	0	0	0	0	0	0	12
5:45 PM	0	6	0	6	0	8	0	8	0	0	0	0	0	0	0	0	14
Total Survey	1	129	8	138	5	192	0	197	0	0	0	0	11	0	13	24	359

Heavy Vehicle Peak Hour Summary 3:30 PM to 4:30 PM

By Approach	Northbound Hwy 224			Southbound Hwy 224			Eastbound SE Freeman Way			Westbound SE Freeman Way			Total
	In	Out	Total	In	Out	Total	In	Out	Total	In	Out	Total	
Volume	56	87	143	83	55	138	0	1	1	8	4	12	147
PHF	0.27			0.27			0.00			0.14			0.26

By Movement	Northbound Hwy 224				Southbound Hwy 224				Eastbound SE Freeman Way				Westbound SE Freeman Way				Total
	L	T	R	Total	L	T	R	Total	L	T	R	Total	L	T	R	Total	
Volume	1	52	3	56	1	82	0	83	0	0	0	0	5	0	3	8	147
PHF	0.25	0.27	0.19	0.27	0.06	0.28	0.00	0.27	0.00	0.00	0.00	0.00	0.21	0.00	0.09	0.14	0.26

Heavy Vehicle Rolling Hour Summary 3:00 PM to 6:00 PM

Interval Start Time	Northbound Hwy 224				Southbound Hwy 224				Eastbound SE Freeman Way				Westbound SE Freeman Way				Interval Total
	L	T	R	Total	L	T	R	Total	L	T	R	Total	L	T	R	Total	
3:00 PM	0	60	3	63	4	91	0	95	0	0	0	0	6	0	10	16	174
3:15 PM	0	56	4	60	4	85	0	89	0	0	0	0	5	0	7	12	161
3:30 PM	1	52	3	56	1	82	0	83	0	0	0	0	5	0	3	8	147
3:45 PM	1	41	4	46	1	75	0	76	0	0	0	0	3	0	4	7	129
4:00 PM	1	39	4	44	0	66	0	66	0	0	0	0	4	0	2	6	116
4:15 PM	1	41	4	46	1	52	0	53	0	0	0	0	3	0	2	5	104
4:30 PM	0	37	3	40	1	43	0	44	0	0	0	0	2	0	3	5	89
4:45 PM	0	34	1	35	1	36	0	37	0	0	0	0	2	0	1	3	75
5:00 PM	0	30	1	31	1	35	0	36	0	0	0	0	1	0	1	2	69

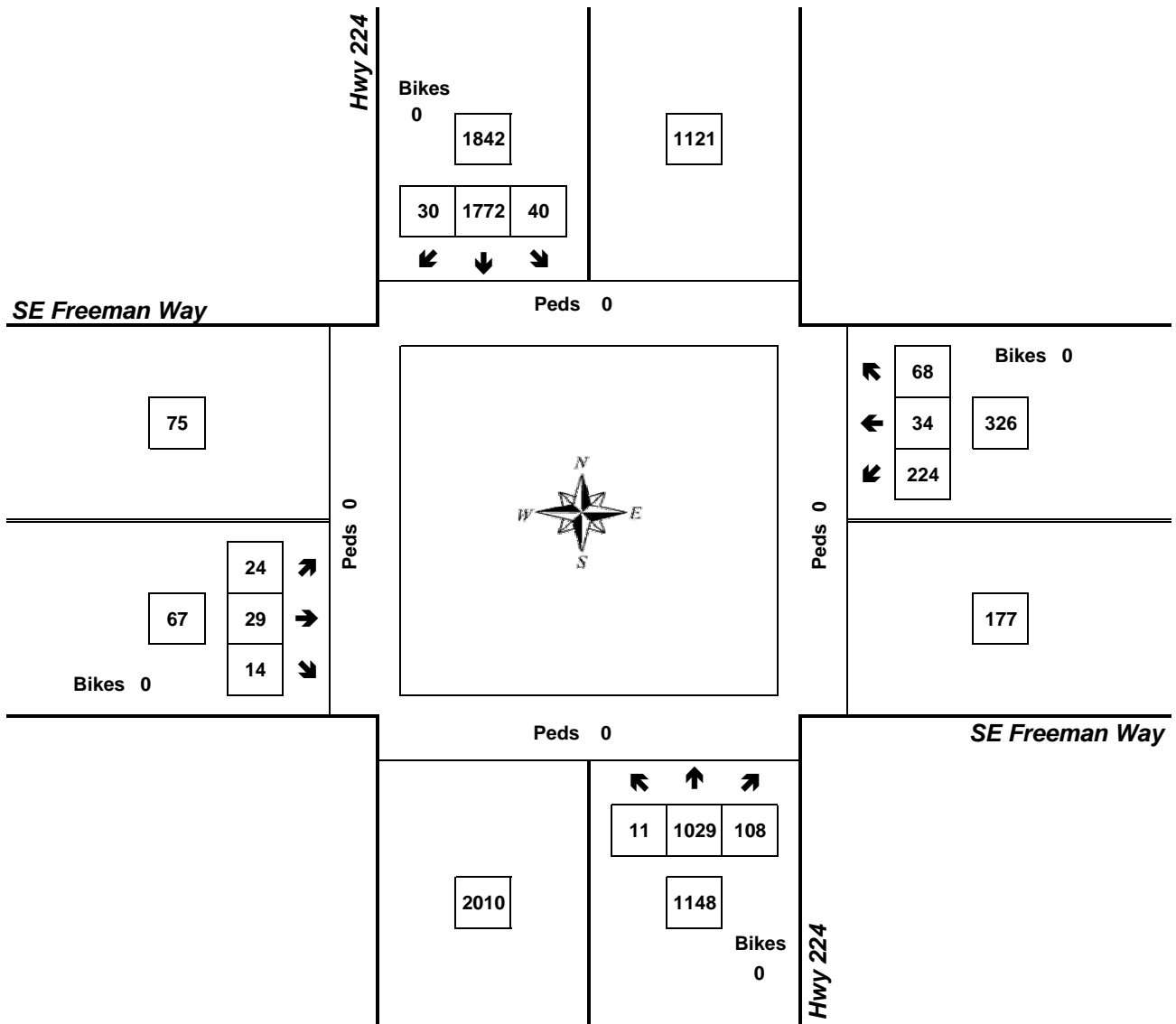
Peak Hour Summary



Clay Carney
(503) 833-2740

Hwy 224 & SE Freeman Way

3:30 PM to 4:30 PM
Thursday, November 30, 2006



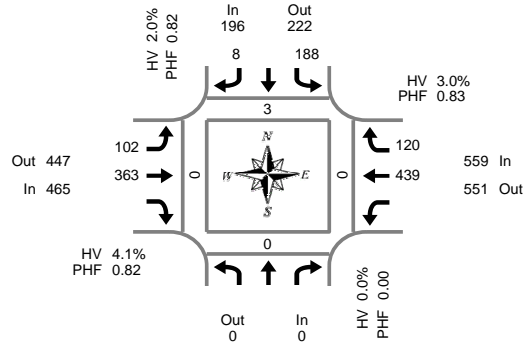
Approach	PHF	HV%	Volume
EB	0.73	0.0%	67
WB	0.84	2.5%	326
NB	0.93	4.9%	1,148
SB	0.92	4.5%	1,842
Intersection	0.92	4.3%	3,383

Count Period: 3:00 PM to 6:00 PM

Total Vehicle Summary



Clay Carney
(503) 833-2740



Hwy 212 EB Ramps & SE Lake Rd

Wednesday, October 11, 2006

4:00 PM to 6:00 PM

5-Minute Interval Summary

4:00 PM to 6:00 PM

Interval Start Time	Northbound Hwy 212 EB Ramps				Southbound Hwy 212 EB Ramps				Eastbound SE Lake Rd			Westbound SE Lake Rd			Interval Total	Pedestrians Crosswalk			
	Bikes	L	R	Bikes	L	T	Bikes	T	R	Bikes	T	R	Bikes	North		South	East	West	
4:00 PM	0	5	1	0	7	29	0	26	8	0	76	0	0	0	0				
4:05 PM	0	8	1	0	8	30	0	21	7	0	75	1	0	0	0				
4:10 PM	0	8	2	0	8	32	0	34	12	0	96	0	0	0	0				
4:15 PM	0	6	0	0	10	21	0	43	7	0	87	0	0	0	0				
4:20 PM	0	13	0	0	8	20	0	41	6	0	88	0	0	0	0				
4:25 PM	0	15	1	0	11	25	0	35	4	0	91	0	0	0	0				
4:30 PM	0	10	0	0	6	22	1	39	3	0	80	0	0	0	0				
4:35 PM	0	10	1	0	12	24	0	43	8	0	98	0	0	0	0				
4:40 PM	0	24	0	0	10	30	0	33	10	0	107	0	0	0	0				
4:45 PM	0	10	0	0	15	40	0	27	18	0	110	0	0	0	0				
4:50 PM	0	14	0	0	8	26	0	30	7	0	85	1	0	0	0				
4:55 PM	0	12	1	0	6	35	0	49	11	0	114	1	0	0	0				
5:00 PM	0	9	0	0	8	31	2	29	10	0	87	0	0	0	0				
5:05 PM	0	15	1	0	5	30	0	40	7	0	98	0	0	0	0				
5:10 PM	0	11	0	0	13	28	0	37	6	0	95	0	0	0	0				
5:15 PM	0	18	2	0	6	17	1	34	8	0	85	0	0	0	0				
5:20 PM	0	18	1	0	10	24	0	54	10	0	117	1	0	0	0				
5:25 PM	0	21	0	0	6	26	0	52	11	0	116	0	0	0	0				
5:30 PM	0	17	0	0	10	31	0	23	17	0	98	0	0	0	0				
5:35 PM	0	17	2	0	6	38	0	28	8	0	99	0	0	0	0				
5:40 PM	0	13	1	0	13	43	0	27	9	0	106	1	0	0	0				
5:45 PM	0	18	0	0	8	30	0	31	12	0	99	0	0	0	0				
5:50 PM	0	19	0	0	11	30	0	35	11	0	106	0	0	0	0				
5:55 PM	0	20	1	0	11	29	0	39	8	0	108	0	0	0	0				
Total Survey	0	331	15	0	216	691	4	850	218	0	2,321	5	0	0	0				

15-Minute Interval Summary

4:00 PM to 6:00 PM

Interval Start Time	Northbound Hwy 212 EB Ramps				Southbound Hwy 212 EB Ramps				Eastbound SE Lake Rd			Westbound SE Lake Rd			Interval Total	Pedestrians Crosswalk			
	Bikes	L	R	Bikes	L	T	Bikes	T	R	Bikes	T	R	Bikes	North		South	East	West	
4:00 PM	0	21	4	0	23	91	0	81	27	0	247	1	0	0	0				
4:15 PM	0	34	1	0	29	66	0	119	17	0	266	0	0	0	0				
4:30 PM	0	44	1	0	28	76	1	115	21	0	285	0	0	0	0				
4:45 PM	0	36	1	0	29	101	0	106	36	0	309	2	0	0	0				
5:00 PM	0	35	1	0	26	89	2	106	23	0	280	0	0	0	0				
5:15 PM	0	57	3	0	22	67	1	140	29	0	318	1	0	0	0				
5:30 PM	0	47	3	0	29	112	0	78	34	0	303	1	0	0	0				
5:45 PM	0	57	1	0	30	89	0	105	31	0	313	0	0	0	0				
Total Survey	0	331	15	0	216	691	4	850	218	0	2,321	5	0	0	0				

Peak Hour Summary

4:55 PM to 5:55 PM

By Approach	Northbound Hwy 212 EB Ramps				Southbound Hwy 212 EB Ramps				Eastbound SE Lake Rd			Westbound SE Lake Rd			Total	Pedestrians Crosswalk					
	In	Out	Total	Bikes	In	Out	Total	Bikes	In	Out	Total	Bikes	In	Out		Total	North	South	East	West	
Volume	0	0	0	0	196	222	418	0	465	447	912	3	559	551	1,110	0	1,220	3	0	0	0
%HV	0.0%				2.0%				4.1%			3.0%			3.3%						
PHF	0.00				0.82				0.82			0.83			0.92						

By Movement	Northbound Hwy 212 EB Ramps				Southbound Hwy 212 EB Ramps				Eastbound SE Lake Rd			Westbound SE Lake Rd			Total					
	Total	L	R	Total	L	T	Total	T	R	Total	T	R	Total							
Volume	0	188	8	196	102	363	465	439	120	559	1,220									
%HV	NA	NA	NA	0.0%	2.1%	NA	0.0%	2.0%	9.8%	2.5%	NA	4.1%	NA	3.4%	1.7%	3.0%	3.3%			
PHF		0.00	0.82	0.67	0.82	0.80	0.81	0.82	0.78	0.79	0.83	0.92								

Rolling Hour Summary

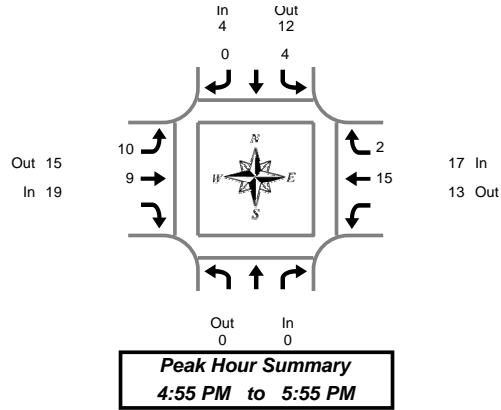
4:00 PM to 6:00 PM

Interval Start Time	Northbound Hwy 212 EB Ramps				Southbound Hwy 212 EB Ramps				Eastbound SE Lake Rd			Westbound SE Lake Rd			Interval Total	Pedestrians Crosswalk			
	Bikes	L	R	Bikes	L	T	Bikes	T	R	Bikes	T	R	Bikes	North		South	East	West	
4:00 PM	0	135	7	0	109	334	1	421	101	0	1,107	3	0	0	0				
4:15 PM	0	149	4	0	112	332	3	446	97	0	1,140	2	0	0	0				
4:30 PM	0	172	6	0	105	333	4	467	109	0	1,192	3	0	0	0				
4:45 PM	0	175	8	0	106	369	3	430	122	0	1,210	4	0	0	0				
5:00 PM	0	196	8	0	107	357	3	429	117	0	1,214	2	0	0	0				

Heavy Vehicle Summary



Clay Carney
(503) 833-2740



Hwy 212 EB Ramps & SE Lake Rd

Wednesday, October 11, 2006

4:00 PM to 6:00 PM

Heavy Vehicle 5-Minute Interval Summary 4:00 PM to 6:00 PM

Interval Start Time	Northbound Hwy 212 EB Ramps			Southbound Hwy 212 EB Ramps			Eastbound SE Lake Rd			Westbound SE Lake Rd			Interval Total
	Total	L	R	Total	L	R	Total	T	Total	T	R	Total	
4:00 PM	0	0	0	0	0	0	0	3	3	0	0	0	3
4:05 PM	0	0	0	0	0	0	0	6	6	0	0	0	6
4:10 PM	0	0	0	0	0	2	2	4	4	1	0	1	5
4:15 PM	0	0	0	0	0	1	1	1	1	2	0	2	3
4:20 PM	0	0	0	0	0	1	1	1	1	1	0	1	2
4:25 PM	0	2	0	2	1	0	1	1	1	0	0	0	3
4:30 PM	0	1	0	1	2	0	2	2	2	2	0	2	5
4:35 PM	0	0	0	0	2	2	4	4	4	4	1	5	9
4:40 PM	0	2	0	2	1	0	1	1	1	2	0	2	5
4:45 PM	0	0	0	0	0	1	1	1	1	2	1	3	4
4:50 PM	0	0	0	0	1	0	1	1	1	0	0	0	1
4:55 PM	0	0	0	0	1	1	2	2	2	1	0	1	3
5:00 PM	0	0	0	0	0	1	1	1	1	1	0	1	2
5:05 PM	0	1	0	1	1	1	2	2	2	2	0	2	5
5:10 PM	0	0	0	0	2	1	3	3	3	1	0	1	4
5:15 PM	0	2	0	2	0	0	0	0	0	1	0	1	3
5:20 PM	0	0	0	0	0	0	0	0	0	2	0	2	2
5:25 PM	0	0	0	0	1	0	1	1	1	2	0	2	3
5:30 PM	0	0	0	0	2	0	2	2	2	1	1	2	4
5:35 PM	0	1	0	1	0	1	1	1	1	1	0	1	3
5:40 PM	0	0	0	0	1	3	4	4	4	1	0	1	5
5:45 PM	0	0	0	0	0	0	0	0	0	1	0	1	1
5:50 PM	0	0	0	0	2	1	3	3	3	1	1	2	5
5:55 PM	0	0	0	0	0	2	2	2	2	2	0	2	4
Total Survey	0	9	0	9	19	27	46	46	46	31	4	35	90

Heavy Vehicle 15-Minute Interval Summary 4:00 PM to 6:00 PM

Interval Start Time	Northbound Hwy 212 EB Ramps			Southbound Hwy 212 EB Ramps			Eastbound SE Lake Rd			Westbound SE Lake Rd			Interval Total
	Total	L	R	Total	L	R	Total	T	Total	T	R	Total	
4:00 PM	0	0	0	0	0	2	2	11	13	1	0	1	14
4:15 PM	0	2	0	2	1	2	3	3	3	3	0	3	8
4:30 PM	0	3	0	3	5	2	7	7	7	8	1	9	19
4:45 PM	0	0	0	0	2	2	4	4	4	3	1	4	8
5:00 PM	0	1	0	1	3	3	6	6	6	4	0	4	11
5:15 PM	0	2	0	2	1	0	1	1	1	5	0	5	8
5:30 PM	0	1	0	1	3	4	7	7	7	3	1	4	12
5:45 PM	0	0	0	0	2	3	5	5	5	4	1	5	10
Total Survey	0	9	0	9	19	27	46	46	46	31	4	35	90

Heavy Vehicle Peak Hour Summary 4:55 PM to 5:55 PM

By Approach	Northbound Hwy 212 EB Ramps			Southbound Hwy 212 EB Ramps			Eastbound SE Lake Rd			Westbound SE Lake Rd			Total
	In	Out	Total	In	Out	Total	In	Out	Total	In	Out	Total	
Volume	0	0	0	4	12	16	19	15	34	17	13	30	40
PHF	0.00			0.33			0.68			0.71			0.83

By Movement	Northbound Hwy 212 EB Ramps			Southbound Hwy 212 EB Ramps			Eastbound SE Lake Rd			Westbound SE Lake Rd			Total
	Total	L	R	Total	L	R	Total	T	Total	T	R	Total	
Volume	0	4	0	4	10	9	19	9	19	15	2	17	40
PHF	0.00	0.33	0.00	0.33	0.83	0.56	0.68	0.75	0.50	0.71			0.83

Heavy Vehicle Rolling Hour Summary 4:00 PM to 6:00 PM

Interval Start Time	Northbound Hwy 212 EB Ramps			Southbound Hwy 212 EB Ramps			Eastbound SE Lake Rd			Westbound SE Lake Rd			Interval Total
	Total	L	R	Total	L	R	Total	T	Total	T	R	Total	
4:00 PM	0	5	0	5	10	17	27	27	27	15	2	17	49
4:15 PM	0	6	0	6	11	9	20	20	20	18	2	20	46
4:30 PM	0	6	0	6	11	7	18	18	18	20	2	22	46
4:45 PM	0	4	0	4	9	9	18	18	18	15	2	17	39
5:00 PM	0	4	0	4	9	10	19	19	19	16	2	18	41

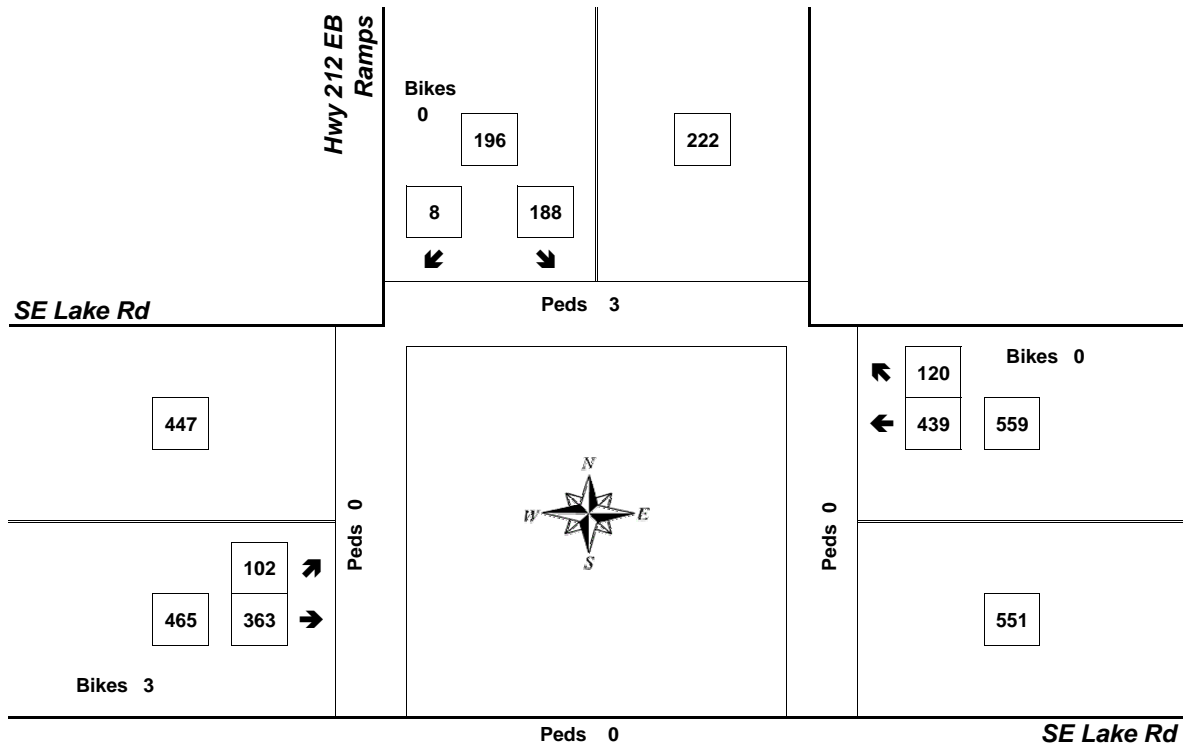
Peak Hour Summary



Clay Carney
(503) 833-2740

Hwy 212 EB Ramps & SE Lake Rd

4:55 PM to 5:55 PM
Wednesday, October 11, 2006



Bikes
0

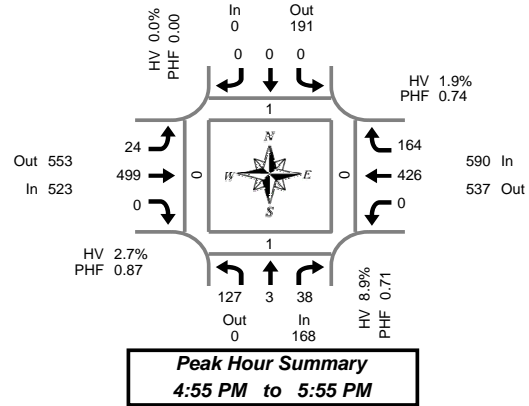
Approach	PHF	HV%	Volume
EB	0.82	4.1%	465
WB	0.83	3.0%	559
NB	0.00	0.0%	0
SB	0.82	2.0%	196
Intersection	0.92	3.3%	1,220

Count Period: 4:00 PM to 6:00 PM

Total Vehicle Summary



Clay Carney
(503) 833-2740



Hwy 212 WB Ramps & SE Lake Rd

Wednesday, October 11, 2006

4:00 PM to 6:00 PM

5-Minute Interval Summary

4:00 PM to 6:00 PM

Interval Start Time	Northbound Hwy 212 WB Ramps				Southbound Hwy 212 WB Ramps				Eastbound SE Lake Rd				Westbound SE Lake Rd				Interval Total	Pedestrians Crosswalk				
	L	T	R	Bikes	L	T	R	Bikes	L	T	R	Bikes	L	T	R	Bikes		North	South	East	West	
4:00 PM	9	0	1	0	0	0	0	0	1	42	0	0	0	37	9	0	0	99	0	0	0	0
4:05 PM	7	0	0	0	0	0	0	0	2	47	0	0	0	34	10	0	0	100	0	0	0	0
4:10 PM	3	0	1	0	0	0	0	0	0	31	0	0	0	33	15	0	0	83	0	0	0	0
4:15 PM	7	2	6	0	0	0	0	0	1	33	0	0	0	73	14	0	0	136	0	0	0	0
4:20 PM	10	0	2	0	0	0	0	0	3	46	0	0	0	38	15	0	0	114	0	0	0	0
4:25 PM	9	0	3	0	0	0	0	0	0	22	0	0	0	20	9	1	0	63	0	0	0	0
4:30 PM	5	1	1	0	0	0	0	0	4	38	0	1	0	27	8	0	0	84	0	0	0	0
4:35 PM	11	0	0	0	0	0	0	0	2	33	0	0	0	37	12	0	0	95	0	0	0	0
4:40 PM	7	0	3	0	0	0	0	0	1	46	0	0	0	33	14	0	0	104	0	0	0	0
4:45 PM	7	0	3	0	0	0	0	0	0	39	0	0	0	32	10	0	0	91	0	0	0	0
4:50 PM	7	1	0	0	0	0	0	0	3	34	0	0	0	46	13	0	0	104	0	0	0	0
4:55 PM	9	0	3	0	0	0	0	0	4	49	0	0	0	34	19	0	0	118	0	0	0	0
5:00 PM	12	0	2	0	0	0	0	0	2	38	0	0	0	31	17	0	0	102	0	0	0	0
5:05 PM	7	0	3	0	0	0	0	0	1	36	0	2	0	33	13	0	0	93	0	0	0	0
5:10 PM	8	0	2	0	0	0	0	0	0	44	0	0	0	40	12	0	0	106	0	1	0	0
5:15 PM	4	0	1	0	0	0	0	0	2	33	0	0	0	51	20	0	0	111	0	0	0	0
5:20 PM	11	0	4	0	0	0	0	0	3	44	0	0	0	57	19	0	0	138	0	0	0	0
5:25 PM	15	0	2	0	0	0	0	0	1	43	0	0	0	31	13	0	0	105	0	0	0	0
5:30 PM	11	1	6	0	0	0	0	0	2	29	0	0	0	29	8	0	0	86	1	0	0	0
5:35 PM	5	0	3	0	0	0	0	0	1	49	0	0	0	25	11	0	0	94	0	0	0	0
5:40 PM	18	1	1	0	0	0	0	0	3	52	0	0	0	36	11	0	0	122	0	0	0	0
5:45 PM	9	1	5	0	0	0	0	0	4	42	0	0	0	23	13	0	0	97	0	0	0	0
5:50 PM	18	0	6	0	0	0	0	0	1	40	0	0	0	36	8	0	0	109	0	0	0	0
5:55 PM	17	0	2	0	0	0	0	0	0	51	0	0	0	34	10	0	0	114	0	0	0	0
Total Survey	226	7	60	0	0	0	0	0	41	961	0	3	0	870	303	1	0	2,468	1	1	0	0

15-Minute Interval Summary

4:00 PM to 6:00 PM

Interval Start Time	Northbound Hwy 212 WB Ramps				Southbound Hwy 212 WB Ramps				Eastbound SE Lake Rd				Westbound SE Lake Rd				Interval Total	Pedestrians Crosswalk				
	L	T	R	Bikes	L	T	R	Bikes	L	T	R	Bikes	L	T	R	Bikes		North	South	East	West	
4:00 PM	19	0	2	0	0	0	0	0	3	120	0	0	0	104	34	0	0	282	0	0	0	0
4:15 PM	26	2	11	0	0	0	0	0	4	101	0	0	0	131	38	1	0	313	0	0	0	0
4:30 PM	23	1	4	0	0	0	0	0	7	117	0	1	0	97	34	0	0	283	0	0	0	0
4:45 PM	23	1	6	0	0	0	0	0	7	122	0	0	0	112	42	0	0	313	0	0	0	0
5:00 PM	27	0	7	0	0	0	0	0	3	118	0	2	0	104	42	0	0	301	0	1	0	0
5:15 PM	30	0	7	0	0	0	0	0	6	120	0	0	0	139	52	0	0	354	0	0	0	0
5:30 PM	34	2	10	0	0	0	0	0	6	130	0	0	0	90	30	0	0	302	1	0	0	0
5:45 PM	44	1	13	0	0	0	0	0	5	133	0	0	0	93	31	0	0	320	0	0	0	0
Total Survey	226	7	60	0	0	0	0	0	41	961	0	3	0	870	303	1	0	2,468	1	1	0	0

Peak Hour Summary

4:55 PM to 5:55 PM

By Approach	Northbound Hwy 212 WB Ramps				Southbound Hwy 212 WB Ramps				Eastbound SE Lake Rd				Westbound SE Lake Rd				Total	Pedestrians Crosswalk			
	In	Out	Total	Bikes	In	Out	Total	Bikes	In	Out	Total	Bikes	In	Out	Total	Bikes		North	South	East	West
Volume	168	0	168	0	0	191	191	0	523	553	1,076	2	590	537	1,127	0	1,281	1	1	0	0
%HV	8.9%				0.0%				2.7%				1.9%				3.1%				
PHF	0.71				0.00				0.87				0.74				0.90				

By Movement	Northbound Hwy 212 WB Ramps				Southbound Hwy 212 WB Ramps				Eastbound SE Lake Rd				Westbound SE Lake Rd				Total
	L	T	R	Total	L	T	R	Total	L	T	R	Total	L	T	R	Total	
Volume	127	3	38	168	0	0	0	0	24	499	0	523	0	426	164	590	1,281
%HV	6.3%	0.0%	18.4%	8.9%	0.0%	0.0%	0.0%	0.0%	0.0%	2.8%	0.0%	2.7%	0.0%	1.9%	1.8%	1.9%	3.1%
PHF	0.71	0.38	0.79	0.71	0.00	0.00	0.00	0.00	0.75	0.87	0.00	0.87	0.00	0.72	0.79	0.74	0.90

Rolling Hour Summary

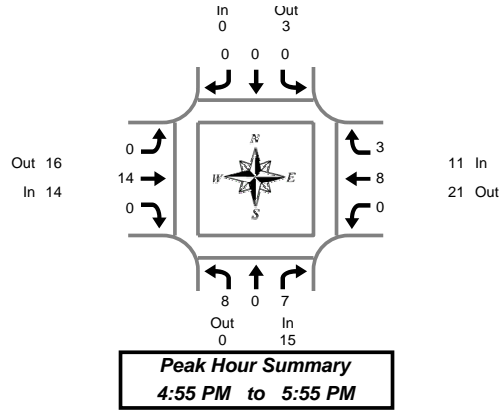
4:00 PM to 6:00 PM

Interval Start Time	Northbound Hwy 212 WB Ramps				Southbound Hwy 212 WB Ramps				Eastbound SE Lake Rd				Westbound SE Lake Rd				Interval Total	Pedestrians Crosswalk				
	L	T	R	Bikes	L	T	R	Bikes	L	T	R	Bikes	L	T	R	Bikes		North	South	East	West	
4:00 PM	91	4	23	0	0	0	0	0	21	460	0	1	0	444	148	1	0	1,191	0	0	0	0
4:15 PM	99	4	28	0	0	0	0	0	21	458	0	3	0	444	156	1	0	1,210	0	1	0	0
4:30 PM	103	2	24	0	0	0	0	0	23	477	0	3	0	452	170	0	0	1,251	0	1	0	0
4:45 PM	114	3	30	0	0	0	0	0	22	490	0	2	0	445	166	0	0	1,270	1	1	0	0
5:00 PM	135	3	37	0	0	0	0	0	20	501	0	2	0	426	155	0	0	1,277	1	1	0	0

Heavy Vehicle Summary



Clay Carney
(503) 833-2740



Hwy 212 WB Ramps & SE Lake Rd

Wednesday, October 11, 2006

4:00 PM to 6:00 PM

Heavy Vehicle 5-Minute Interval Summary

4:00 PM to 6:00 PM

Interval Start Time	Northbound Hwy 212 WB Ramps				Southbound Hwy 212 WB Ramps				Eastbound SE Lake Rd				Westbound SE Lake Rd				Interval Total
	L	T	R	Total	L	T	R	Total	L	T	R	Total	L	T	R	Total	
4:00 PM	0	0	0	0	0	0	0	0	0	4	0	4	0	1	0	1	5
4:05 PM	0	0	0	0	0	0	0	0	0	6	0	6	0	0	0	0	6
4:10 PM	0	0	0	0	0	0	0	0	0	3	0	3	0	0	0	0	3
4:15 PM	1	0	2	3	0	0	0	0	0	0	0	0	0	1	0	1	4
4:20 PM	0	0	1	1	0	0	0	0	0	0	0	0	0	1	2	3	4
4:25 PM	1	0	1	2	0	0	0	0	0	2	0	2	0	0	0	0	4
4:30 PM	0	0	0	0	0	0	0	0	0	1	0	1	0	3	0	3	4
4:35 PM	0	0	0	0	0	0	0	0	0	2	0	2	0	3	1	4	6
4:40 PM	2	0	0	2	0	0	0	0	0	4	0	4	0	0	0	0	6
4:45 PM	0	0	1	1	0	0	0	0	0	0	0	0	0	0	0	0	1
4:50 PM	1	0	0	1	0	0	0	0	0	1	0	1	0	1	1	2	4
4:55 PM	0	0	2	2	0	0	0	0	0	1	0	1	0	0	0	0	3
5:00 PM	0	0	0	0	0	0	0	0	0	2	0	2	0	2	0	2	4
5:05 PM	0	0	0	0	0	0	0	0	0	2	0	2	0	0	0	0	2
5:10 PM	0	0	1	1	0	0	0	0	0	0	0	0	0	2	1	3	4
5:15 PM	0	0	0	0	0	0	0	0	0	0	0	0	0	1	1	1	1
5:20 PM	1	0	0	1	0	0	0	0	0	1	0	1	0	2	1	3	5
5:25 PM	2	0	0	2	0	0	0	0	0	1	0	1	0	0	0	0	3
5:30 PM	1	0	1	2	0	0	0	0	0	1	0	1	0	1	0	1	4
5:35 PM	3	0	2	5	0	0	0	0	0	5	0	5	0	0	0	0	10
5:40 PM	0	0	0	0	0	0	0	0	0	0	0	0	0	0	0	0	0
5:45 PM	1	0	1	2	0	0	0	0	0	1	0	1	0	1	0	1	4
5:50 PM	0	0	0	0	0	0	0	0	0	0	0	0	0	0	0	0	0
5:55 PM	0	0	0	0	0	0	0	0	0	1	0	1	0	1	0	1	2
Total Survey	13	0	12	25	0	0	0	0	0	38	0	38	0	19	7	26	89

Heavy Vehicle 15-Minute Interval Summary

4:00 PM to 6:00 PM

Interval Start Time	Northbound Hwy 212 WB Ramps				Southbound Hwy 212 WB Ramps				Eastbound SE Lake Rd				Westbound SE Lake Rd				Interval Total
	L	T	R	Total	L	T	R	Total	L	T	R	Total	L	T	R	Total	
4:00 PM	0	0	0	0	0	0	0	0	0	13	0	13	0	1	0	1	14
4:15 PM	2	0	4	6	0	0	0	0	0	2	0	2	0	2	2	4	12
4:30 PM	2	0	0	2	0	0	0	0	0	7	0	7	0	6	1	7	16
4:45 PM	1	0	3	4	0	0	0	0	0	2	0	2	0	1	1	2	8
5:00 PM	0	0	1	1	0	0	0	0	0	4	0	4	0	4	1	5	10
5:15 PM	3	0	0	3	0	0	0	0	0	2	0	2	0	2	2	4	9
5:30 PM	4	0	3	7	0	0	0	0	0	6	0	6	0	1	0	1	14
5:45 PM	1	0	1	2	0	0	0	0	0	2	0	2	0	2	0	2	6
Total Survey	13	0	12	25	0	0	0	0	0	38	0	38	0	19	7	26	89

Heavy Vehicle Peak Hour Summary

4:55 PM to 5:55 PM

By Approach	Northbound Hwy 212 WB Ramps			Southbound Hwy 212 WB Ramps			Eastbound SE Lake Rd			Westbound SE Lake Rd			Total
	In	Out	Total	In	Out	Total	In	Out	Total	In	Out	Total	
Volume	15	0	15	0	3	3	14	16	30	11	21	32	40
PHF	0.42			0.00			0.50			0.39			0.59

By Movement	Northbound Hwy 212 WB Ramps				Southbound Hwy 212 WB Ramps				Eastbound SE Lake Rd				Westbound SE Lake Rd				Total
	L	T	R	Total	L	T	R	Total	L	T	R	Total	L	T	R	Total	
Volume	8	0	7	15	0	0	0	0	0	14	0	14	0	8	3	11	40
PHF	0.33	0.00	0.58	0.42	0.00	0.00	0.00	0.00	0.00	0.50	0.00	0.50	0.00	0.50	0.25	0.39	0.59

Heavy Vehicle Rolling Hour Summary

4:00 PM to 6:00 PM

Interval Start Time	Northbound Hwy 212 WB Ramps				Southbound Hwy 212 WB Ramps				Eastbound SE Lake Rd				Westbound SE Lake Rd				Interval Total
	L	T	R	Total	L	T	R	Total	L	T	R	Total	L	T	R	Total	
4:00 PM	5	0	7	12	0	0	0	0	0	24	0	24	0	10	4	14	50
4:15 PM	5	0	8	13	0	0	0	0	0	15	0	15	0	13	5	18	46
4:30 PM	6	0	4	10	0	0	0	0	0	15	0	15	0	13	5	18	43
4:45 PM	8	0	7	15	0	0	0	0	0	14	0	14	0	8	4	12	41
5:00 PM	8	0	5	13	0	0	0	0	0	14	0	14	0	9	3	12	39

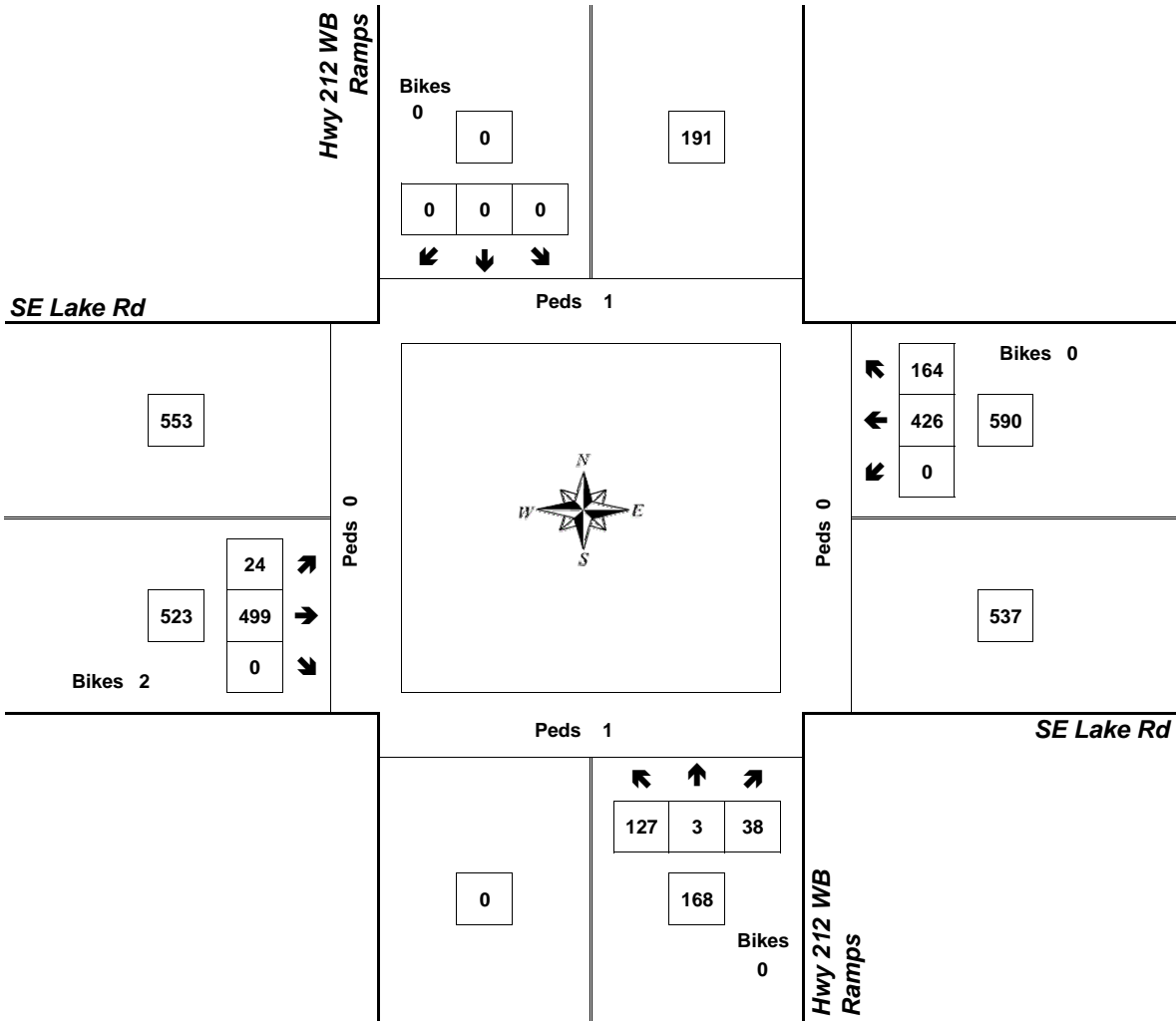
Peak Hour Summary



Clay Carney
(503) 833-2740

Hwy 212 WB Ramps & SE Lake Rd

4:55 PM to 5:55 PM
Wednesday, October 11, 2006



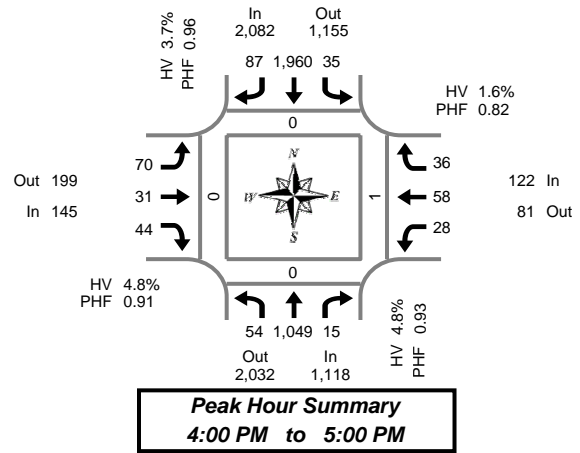
Approach	PHF	HV%	Volume
EB	0.87	2.7%	523
WB	0.74	1.9%	590
NB	0.71	8.9%	168
SB	0.00	0.0%	0
Intersection	0.90	3.1%	1,281

Count Period: 4:00 PM to 6:00 PM

Total Vehicle Summary



Clay Carney
(503) 833-2740



Hwy 224 & SE Rusk Rd

Thursday, November 30, 2006
3:00 PM to 6:00 PM

15-Minute Interval Summary

3:00 PM to 6:00 PM

Interval Start Time	Northbound Hwy 224				Southbound Hwy 224				Eastbound SE Rusk Rd				Westbound SE Rusk Rd				Interval Total	Pedestrians Crosswalk			
	L	T	R	Bikes	L	T	R	Bikes	L	T	R	Bikes	L	T	R	Bikes		North	South	East	West
3:00 PM	16	283	3	0	3	403	12	0	17	1	12	0	0	14	3	0	0	0	0	0	0
3:15 PM	14	266	5	0	5	403	20	0	15	3	10	0	5	8	1	0	0	0	0	0	0
3:30 PM	19	267	2	0	2	403	22	0	21	4	22	1	7	17	5	0	0	0	0	0	0
3:45 PM	12	294	0	0	2	471	19	0	15	10	29	0	6	9	3	0	0	0	1	0	0
4:00 PM	13	262	2	0	5	516	20	0	20	6	13	0	10	14	12	0	0	0	0	0	0
4:15 PM	10	285	4	0	10	512	16	0	14	7	10	0	6	11	6	0	0	0	0	0	0
4:30 PM	13	223	5	0	12	447	22	0	19	9	12	0	9	19	9	1	0	0	1	0	0
4:45 PM	18	279	4	0	8	485	29	0	17	9	9	0	3	14	9	0	0	0	0	0	0
5:00 PM	18	249	6	0	2	459	22	0	23	8	16	0	5	16	9	0	0	0	0	0	0
5:15 PM	13	310	4	0	3	484	15	0	13	6	15	0	6	6	5	0	0	0	0	0	0
5:30 PM	11	263	0	0	4	436	22	0	16	4	6	0	4	11	7	0	0	0	0	0	0
5:45 PM	9	219	1	0	1	452	21	0	11	4	5	0	6	4	5	0	0	0	0	0	0
Total Survey	166	3,200	36	0	57	5,471	240	0	201	71	159	1	67	143	74	1	0	0	2	0	0

Peak Hour Summary

4:00 PM to 5:00 PM

By Approach	Northbound Hwy 224				Southbound Hwy 224				Eastbound SE Rusk Rd				Westbound SE Rusk Rd				Total	Pedestrians Crosswalk			
	In	Out	Total	Bikes	In	Out	Total	Bikes	In	Out	Total	Bikes	In	Out	Total	Bikes		North	South	East	West
Volume	1,118	2,032	3,150	0	2,082	1,155	3,237	0	145	199	344	0	122	81	203	1	3,467	0	0	1	0
%HV	4.8%				3.7%				4.8%				1.6%				4.0%				
PHF	0.93				0.96				0.91				0.82				0.97				

By Movement	Northbound Hwy 224				Southbound Hwy 224				Eastbound SE Rusk Rd				Westbound SE Rusk Rd				Total
	L	T	R	Total	L	T	R	Total	L	T	R	Total	L	T	R	Total	
Volume	54	1,049	15	1,118	35	1,960	87	2,082	70	31	44	145	28	58	36	122	3,467
%HV	3.7%	4.8%	13.3%	4.8%	2.9%	3.8%	1.1%	3.7%	0.0%	6.5%	11.4%	4.8%	3.6%	1.7%	0.0%	1.6%	4.0%
PHF	0.75	0.92	0.75	0.93	0.73	0.95	0.75	0.96	0.88	0.86	0.85	0.91	0.70	0.76	0.75	0.82	0.97

Rolling Hour Summary

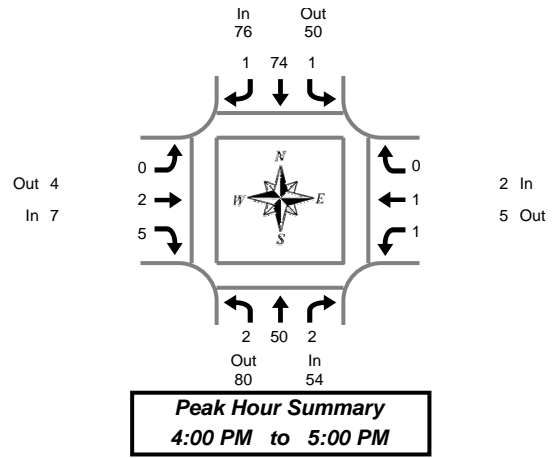
3:00 PM to 6:00 PM

Interval Start Time	Northbound Hwy 224				Southbound Hwy 224				Eastbound SE Rusk Rd				Westbound SE Rusk Rd				Interval Total	Pedestrians Crosswalk			
	L	T	R	Bikes	L	T	R	Bikes	L	T	R	Bikes	L	T	R	Bikes		North	South	East	West
3:00 PM	61	1,110	10	0	12	1,680	73	0	68	18	73	1	18	48	12	0	0	0	1	0	0
3:15 PM	58	1,089	9	0	14	1,793	81	0	71	23	74	1	28	48	21	0	0	0	1	0	0
3:30 PM	54	1,108	8	0	19	1,902	77	0	70	27	74	1	29	51	26	0	0	0	1	0	0
3:45 PM	48	1,064	11	0	29	1,946	77	0	68	32	64	0	31	53	30	1	0	0	2	0	0
4:00 PM	54	1,049	15	0	35	1,960	87	0	70	31	44	0	28	58	36	1	0	0	1	0	0
4:15 PM	59	1,036	19	0	32	1,903	89	0	73	33	47	0	23	60	33	1	0	0	1	0	0
4:30 PM	62	1,061	19	0	25	1,875	88	0	72	32	52	0	23	55	32	1	0	0	1	0	0
4:45 PM	60	1,101	14	0	17	1,864	88	0	69	27	46	0	18	47	30	0	0	0	0	0	0
5:00 PM	51	1,041	11	0	10	1,831	80	0	63	22	42	0	21	37	26	0	0	0	0	0	0

Heavy Vehicle Summary



Clay Carney
(503) 833-2740



Hwy 224 & SE Rusk Rd

Thursday, November 30, 2006
3:00 PM to 6:00 PM

Heavy Vehicle 15-Minute Interval Summary 3:00 PM to 6:00 PM

Interval Start Time	Northbound Hwy 224				Southbound Hwy 224				Eastbound SE Rusk Rd				Westbound SE Rusk Rd				Interval Total
	L	T	R	Total	L	T	R	Total	L	T	R	Total	L	T	R	Total	
3:00 PM	2	15	0	17	0	33	0	33	0	0	0	0	0	0	0	0	50
3:15 PM	0	20	0	20	1	23	0	24	1	0	1	2	3	0	0	3	49
3:30 PM	0	14	0	14	0	26	0	26	0	1	0	1	1	0	0	1	42
3:45 PM	0	16	0	16	0	17	0	17	0	0	2	2	1	0	0	1	36
4:00 PM	0	12	0	12	0	21	1	22	0	0	1	1	0	0	0	0	35
4:15 PM	1	18	2	21	0	21	0	21	0	1	2	3	0	0	0	0	45
4:30 PM	1	11	0	12	1	16	0	17	0	0	2	2	1	1	0	2	33
4:45 PM	0	9	0	9	0	16	0	16	0	1	0	1	0	0	0	0	26
5:00 PM	0	10	1	11	0	8	0	8	0	0	0	0	0	0	0	0	19
5:15 PM	0	8	1	9	0	13	0	13	0	0	0	0	1	0	0	1	23
5:30 PM	0	9	0	9	0	10	0	10	0	0	0	0	0	0	0	0	19
5:45 PM	0	8	1	9	0	8	0	8	0	0	0	0	1	0	0	1	18
Total Survey	4	150	5	159	2	212	1	215	1	3	8	12	8	1	0	9	395

Heavy Vehicle Peak Hour Summary 4:00 PM to 5:00 PM

By Approach	Northbound Hwy 224			Southbound Hwy 224			Eastbound SE Rusk Rd			Westbound SE Rusk Rd			Total
	In	Out	Total	In	Out	Total	In	Out	Total	In	Out	Total	
Volume	54	80	134	76	50	126	7	4	11	2	5	7	139
PHF	0.26			0.23			0.29			0.10			0.25

By Movement	Northbound Hwy 224				Southbound Hwy 224				Eastbound SE Rusk Rd				Westbound SE Rusk Rd				Total
	L	T	R	Total	L	T	R	Total	L	T	R	Total	L	T	R	Total	
Volume	2	50	2	54	1	74	1	76	0	2	5	7	1	1	0	2	139
PHF	0.25	0.25	0.25	0.26	0.25	0.23	0.25	0.23	0.00	0.25	0.25	0.29	0.05	0.25	0.00	0.10	0.25

Heavy Vehicle Rolling Hour Summary 3:00 PM to 6:00 PM

Interval Start Time	Northbound Hwy 224				Southbound Hwy 224				Eastbound SE Rusk Rd				Westbound SE Rusk Rd				Interval Total
	L	T	R	Total	L	T	R	Total	L	T	R	Total	L	T	R	Total	
3:00 PM	2	65	0	67	1	99	0	100	1	1	3	5	5	0	0	5	177
3:15 PM	0	62	0	62	1	87	1	89	1	1	4	6	5	0	0	5	162
3:30 PM	1	60	2	63	0	85	1	86	0	2	5	7	2	0	0	2	158
3:45 PM	2	57	2	61	1	75	1	77	0	1	7	8	2	1	0	3	149
4:00 PM	2	50	2	54	1	74	1	76	0	2	5	7	1	1	0	2	139
4:15 PM	2	48	3	53	1	61	0	62	0	2	4	6	1	1	0	2	123
4:30 PM	1	38	2	41	1	53	0	54	0	1	2	3	2	1	0	3	101
4:45 PM	0	36	2	38	0	47	0	47	0	1	0	1	1	0	0	1	87
5:00 PM	0	35	3	38	0	39	0	39	0	0	0	0	2	0	0	2	79

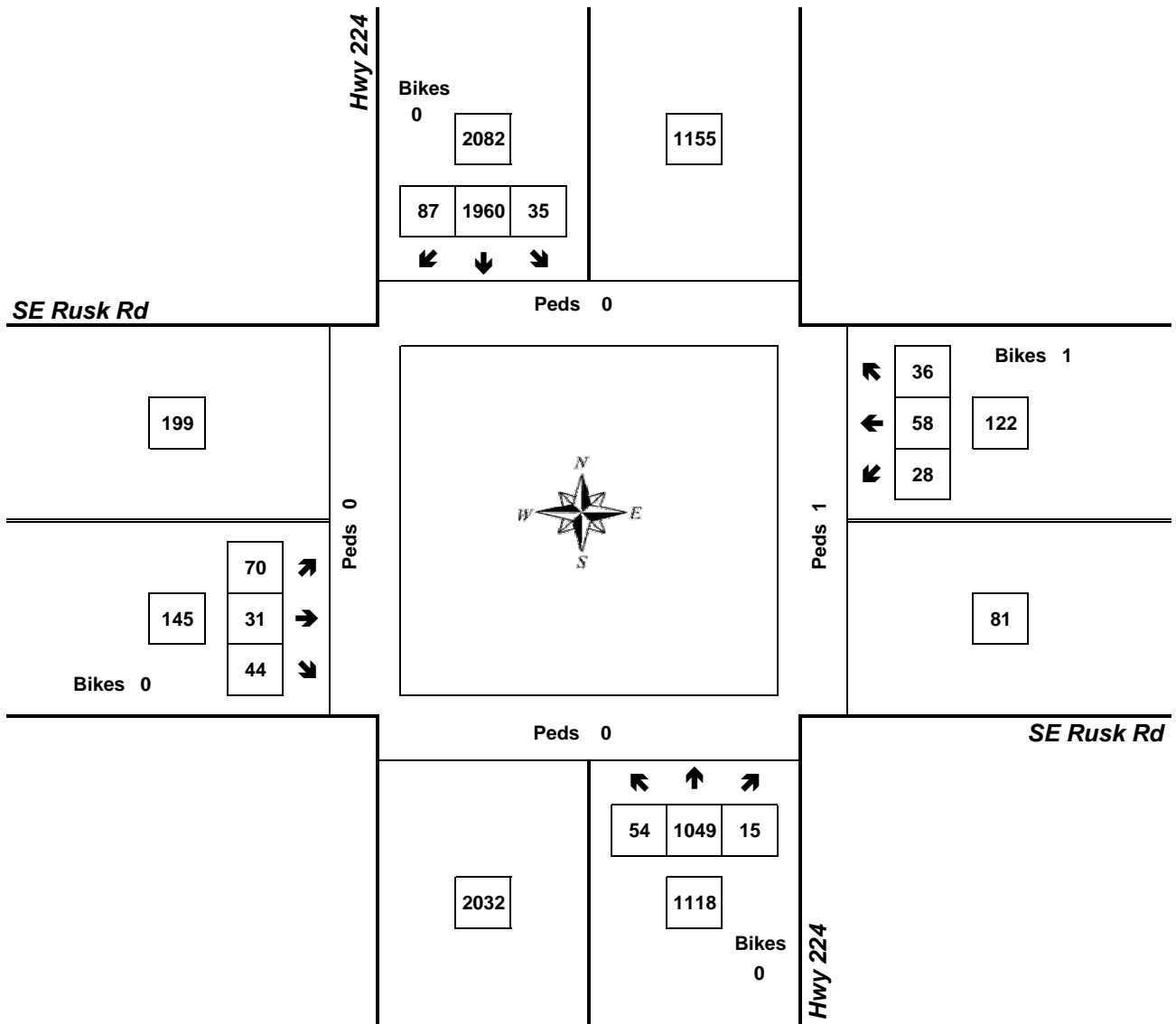
Peak Hour Summary



Clay Carney
(503) 833-2740

Hwy 224 & SE Rusk Rd

4:00 PM to 5:00 PM
Thursday, November 30, 2006



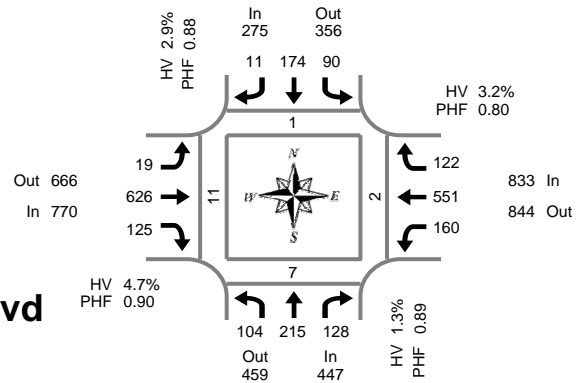
Approach	PHF	HV%	Volume
EB	0.91	4.8%	145
WB	0.82	1.6%	122
NB	0.93	4.8%	1,118
SB	0.96	3.7%	2,082
Intersection	0.97	4.0%	3,467

Count Period: 3:00 PM to 6:00 PM

Total Vehicle Summary



Clay Carney
(503) 833-2740



SE Linwood Ave & SE Johnson Creek Blvd

Tuesday, December 05, 2006
3:00 PM to 6:00 PM

Peak Hour Summary
4:30 PM to 5:30 PM

15-Minute Interval Summary

3:00 PM to 6:00 PM

Interval Start Time	Northbound SE Linwood Ave				Southbound SE Linwood Ave				Eastbound SE Johnson Creek Blvd				Westbound SE Johnson Creek Blvd				Interval Total	Pedestrians Crosswalk			
	L	T	R	Bikes	L	T	R	Bikes	L	T	R	Bikes	L	T	R	Bikes		North	South	East	West
3:00 PM	28	26	24	0	15	19	4	0	6	145	22	0	32	135	0	0	456	0	1	1	2
3:15 PM	24	30	28	0	18	29	3	0	5	149	19	0	27	113	0	0	445	0	2	0	2
3:30 PM	15	32	21	0	27	38	3	1	4	160	31	0	33	129	0	0	493	0	2	0	2
3:45 PM	26	46	33	0	20	39	3	0	7	150	22	0	25	139	0	0	510	0	2	0	4
4:00 PM	30	46	39	0	15	39	1	0	4	135	29	0	29	133	0	0	500	0	3	0	2
4:15 PM	19	42	45	1	16	30	4	0	4	175	22	0	38	126	40	0	561	0	3	0	2
4:30 PM	29	61	36	0	25	47	6	0	7	135	36	0	59	162	38	0	641	0	1	1	3
4:45 PM	26	51	35	1	22	38	1	0	2	179	33	1	30	135	35	0	587	1	3	0	2
5:00 PM	26	54	33	0	22	43	3	0	7	166	26	1	29	107	16	0	532	0	2	1	2
5:15 PM	23	49	24	0	21	46	1	0	3	146	30	0	42	147	33	0	565	0	1	0	4
5:30 PM	15	46	39	0	13	45	2	0	2	145	21	0	35	133	23	0	519	1	0	0	0
5:45 PM	15	28	24	0	24	27	4	0	3	136	24	0	47	120	20	0	472	0	0	0	0
Total Survey	276	511	381	2	238	440	35	1	54	1,821	315	2	426	1,579	205	0	6,281	2	20	3	25

Peak Hour Summary

4:30 PM to 5:30 PM

By Approach	Northbound SE Linwood Ave				Southbound SE Linwood Ave				Eastbound SE Johnson Creek Blvd				Westbound SE Johnson Creek Blvd				Total	Pedestrians Crosswalk			
	In	Out	Total	Bikes	In	Out	Total	Bikes	In	Out	Total	Bikes	In	Out	Total	Bikes		North	South	East	West
Volume	447	459	906	1	275	356	631	0	770	666	1,436	2	833	844	1,677	0	2,325	1	7	2	11
%HV	1.3%				2.9%				4.7%				3.2%				3.3%				
PHF	0.89				0.88				0.90				0.80				0.91				

By Movement	Northbound SE Linwood Ave				Southbound SE Linwood Ave				Eastbound SE Johnson Creek Blvd				Westbound SE Johnson Creek Blvd				Total
	L	T	R	Total	L	T	R	Total	L	T	R	Total	L	T	R	Total	
Volume	104	215	128	447	90	174	11	275	19	626	125	770	160	551	122	833	2,325
%HV	1.9%	1.4%	0.8%	1.3%	5.6%	1.1%	9.1%	2.9%	5.3%	5.0%	3.2%	4.7%	2.5%	3.8%	1.6%	3.2%	3.3%
PHF	0.90	0.88	0.89	0.89	0.90	0.93	0.46	0.88	0.68	0.87	0.87	0.90	0.68	0.85	0.80	0.80	0.91

Rolling Hour Summary

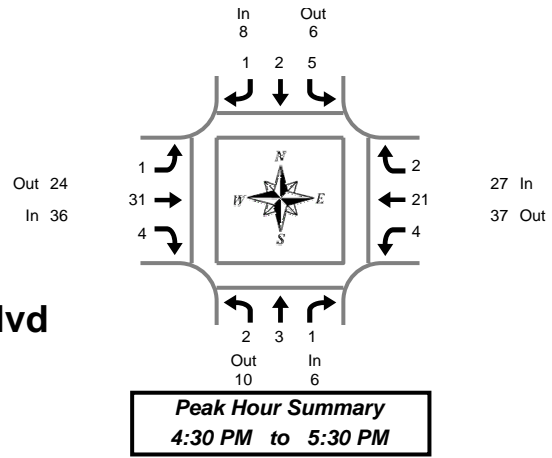
3:00 PM to 6:00 PM

Interval Start Time	Northbound SE Linwood Ave				Southbound SE Linwood Ave				Eastbound SE Johnson Creek Blvd				Westbound SE Johnson Creek Blvd				Interval Total	Pedestrians Crosswalk			
	L	T	R	Bikes	L	T	R	Bikes	L	T	R	Bikes	L	T	R	Bikes		North	South	East	West
3:00 PM	93	134	106	0	80	125	13	1	22	604	94	0	117	516	0	0	1,904	0	7	1	10
3:15 PM	95	154	121	0	80	145	10	1	20	594	101	0	114	514	0	0	1,948	0	9	0	10
3:30 PM	90	166	138	1	78	146	11	1	19	620	104	0	125	527	40	0	2,064	0	10	0	10
3:45 PM	104	195	153	1	76	155	14	0	22	595	109	0	151	560	78	0	2,212	0	9	1	11
4:00 PM	104	200	155	2	78	154	12	0	17	624	120	1	156	556	113	0	2,289	1	10	1	9
4:15 PM	100	208	149	2	85	158	14	0	20	655	117	2	156	530	129	0	2,321	1	9	2	9
4:30 PM	104	215	128	1	90	174	11	0	19	626	125	2	160	551	122	0	2,325	1	7	2	11
4:45 PM	90	200	131	1	78	172	7	0	14	636	110	2	136	522	107	0	2,203	2	6	1	8
5:00 PM	79	177	120	0	80	161	10	0	15	593	101	1	153	507	92	0	2,088	1	3	1	6

Heavy Vehicle Summary



Clay Carney
(503) 833-2740



SE Linwood Ave & SE Johnson Creek Blvd

Tuesday, December 05, 2006
3:00 PM to 6:00 PM

Heavy Vehicle 15-Minute Interval Summary 3:00 PM to 6:00 PM

Interval Start Time	Northbound SE Linwood Ave				Southbound SE Linwood Ave				Eastbound SE Johnson Creek Blvd				Westbound SE Johnson Creek Blvd				Interval Total
	L	T	R	Total	L	T	R	Total	L	T	R	Total	L	T	R	Total	
3:00 PM	3	0	0	3	1	1	0	2	2	8	1	11	3	9	0	12	28
3:15 PM	3	1	2	6	0	1	0	1	0	14	2	16	0	7	0	7	30
3:30 PM	0	2	1	3	0	0	0	0	0	11	1	12	2	6	0	8	23
3:45 PM	0	1	1	2	0	1	0	1	0	11	1	12	1	4	0	5	20
4:00 PM	1	2	2	5	0	2	0	2	0	8	0	8	1	7	0	8	23
4:15 PM	1	0	4	5	0	0	0	0	0	9	0	9	1	10	3	14	28
4:30 PM	1	1	0	2	1	2	1	4	0	10	1	11	2	9	0	11	28
4:45 PM	0	0	1	1	1	0	0	1	1	8	1	10	0	6	0	6	18
5:00 PM	1	1	0	2	1	0	0	1	0	9	1	10	1	2	0	3	16
5:15 PM	0	1	0	1	2	0	0	2	0	4	1	5	1	4	2	7	15
5:30 PM	1	2	0	3	0	0	0	0	0	3	0	3	1	1	0	2	8
5:45 PM	0	0	0	0	0	0	0	0	0	3	1	4	2	1	0	3	7
Total Survey	11	11	11	33	6	7	1	14	3	98	10	111	15	66	5	86	244

Heavy Vehicle Peak Hour Summary 4:30 PM to 5:30 PM

By Approach	Northbound SE Linwood Ave			Southbound SE Linwood Ave			Eastbound SE Johnson Creek Blvd			Westbound SE Johnson Creek Blvd			Total
	In	Out	Total	In	Out	Total	In	Out	Total	In	Out	Total	
Volume	6	10	16	8	6	14	36	24	60	27	37	64	77
PHF	0.13			0.33			0.23			0.20			0.24

By Movement	Northbound SE Linwood Ave				Southbound SE Linwood Ave				Eastbound SE Johnson Creek Blvd				Westbound SE Johnson Creek Blvd				Total
	L	T	R	Total	L	T	R	Total	L	T	R	Total	L	T	R	Total	
Volume	2	3	1	6	5	2	1	8	1	31	4	36	4	21	2	27	77
PHF	0.08	0.15	0.04	0.13	0.31	0.13	0.25	0.33	0.13	0.22	0.25	0.23	0.20	0.20	0.17	0.20	0.24

Heavy Vehicle Rolling Hour Summary 3:00 PM to 6:00 PM

Interval Start Time	Northbound SE Linwood Ave				Southbound SE Linwood Ave				Eastbound SE Johnson Creek Blvd				Westbound SE Johnson Creek Blvd				Interval Total
	L	T	R	Total	L	T	R	Total	L	T	R	Total	L	T	R	Total	
3:00 PM	6	4	4	14	1	3	0	4	2	44	5	51	6	26	0	32	101
3:15 PM	4	6	6	16	0	4	0	4	0	44	4	48	4	24	0	28	96
3:30 PM	2	5	8	15	0	3	0	3	0	39	2	41	5	27	3	35	94
3:45 PM	3	4	7	14	1	5	1	7	0	38	2	40	5	30	3	38	99
4:00 PM	3	3	7	13	2	4	1	7	1	35	2	38	4	32	3	39	97
4:15 PM	3	2	5	10	3	2	1	6	1	36	3	40	4	27	3	34	90
4:30 PM	2	3	1	6	5	2	1	8	1	31	4	36	4	21	2	27	77
4:45 PM	2	4	1	7	4	0	0	4	1	24	3	28	3	13	2	18	57
5:00 PM	2	4	0	6	3	0	0	3	0	19	3	22	5	8	2	15	46

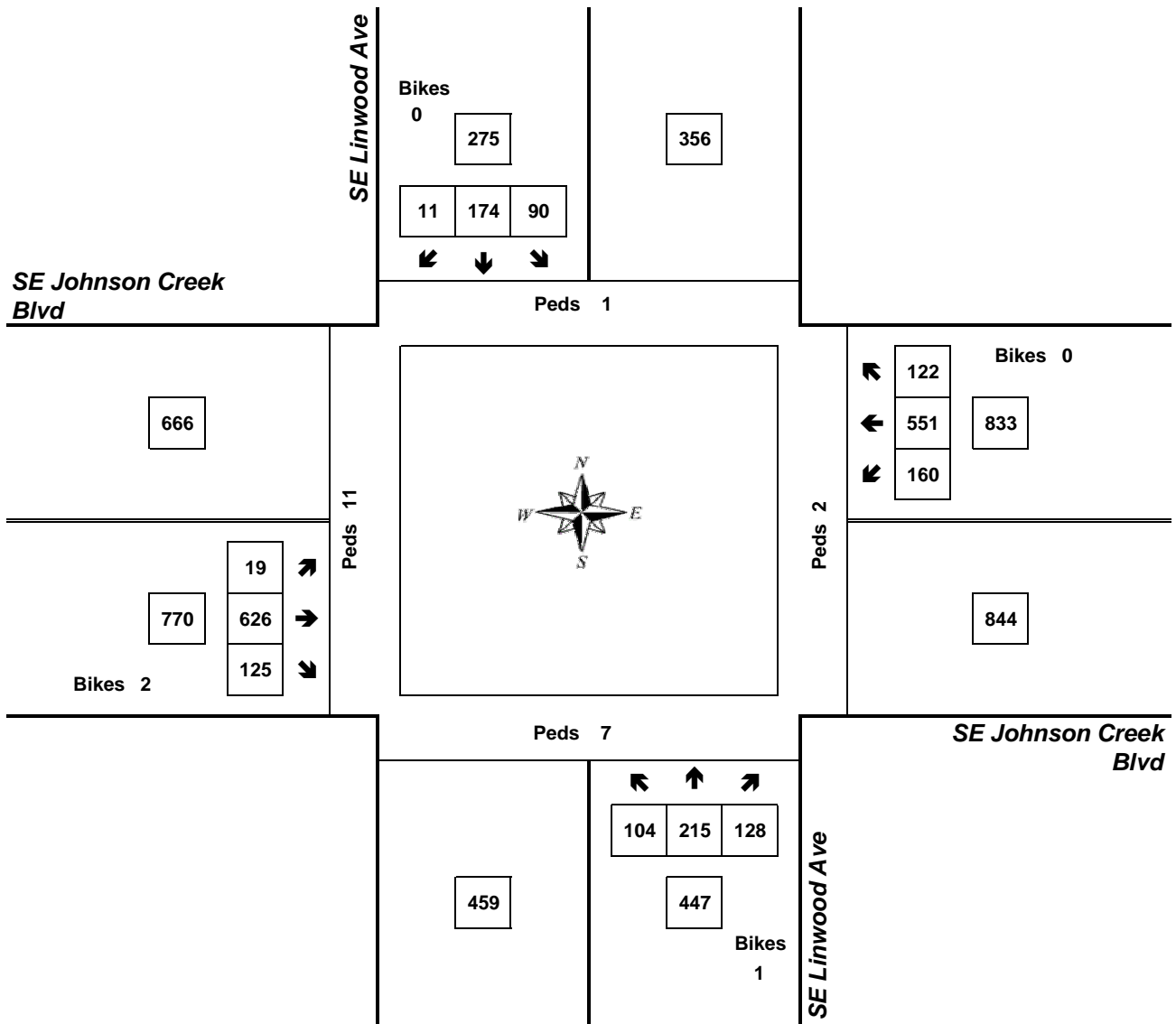
Peak Hour Summary



Clay Carney
(503) 833-2740

SE Linwood Ave & SE Johnson Creek Blvd

4:30 PM to 5:30 PM
Tuesday, December 05, 2006

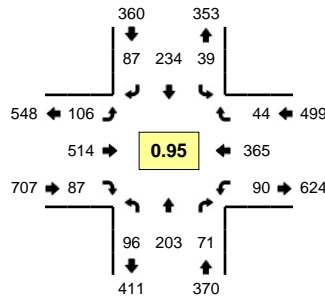


Approach	PHF	HV%	Volume
EB	0.90	4.7%	770
WB	0.80	3.2%	833
NB	0.89	1.3%	447
SB	0.88	2.9%	275
Intersection	0.91	3.3%	2,325

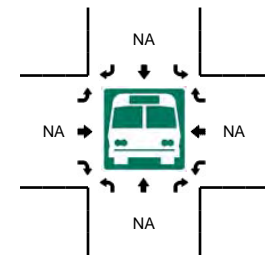
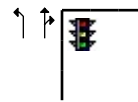
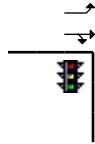
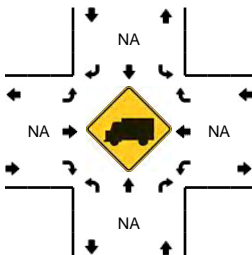
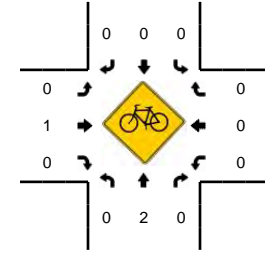
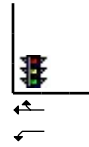
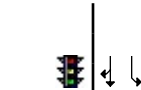
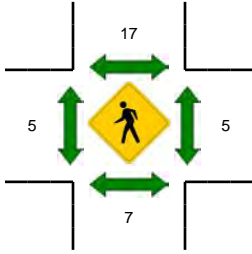
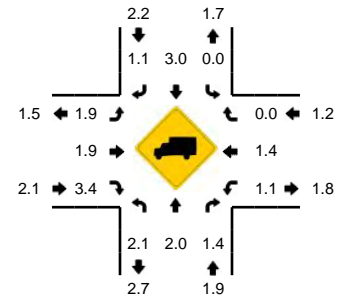
Count Period: 3:00 PM to 6:00 PM

LOCATION: Linwood Ave -- King Rd
CITY/STATE: Milwaukie, OR

QC JOB #: 10776902
DATE: Tue, Jun 12 2012



Peak-Hour: 5:00 PM -- 6:00 PM
Peak 15-Min: 5:30 PM -- 5:45 PM



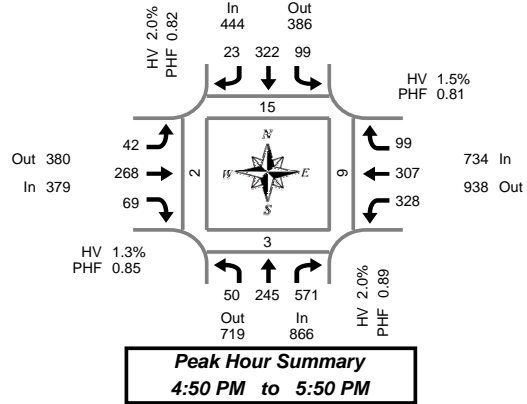
5-Min Count Period Beginning At	Linwood Ave (Northbound)				Linwood Ave (Southbound)				King Rd (Eastbound)				King Rd (Westbound)				Total	Hourly Totals
	Left	Thru	Right	U	Left	Thru	Right	U	Left	Thru	Right	U	Left	Thru	Right	U		
4:00 PM	6	27	10	0	4	13	4	0	4	37	8	0	6	21	5	0	145	
4:05 PM	8	12	6	0	5	14	3	0	8	35	7	0	12	19	3	0	132	
4:10 PM	5	19	5	0	7	7	6	0	3	53	11	0	4	29	3	0	152	
4:15 PM	10	18	5	0	1	18	4	0	16	34	6	0	9	24	3	0	148	
4:20 PM	5	14	10	0	3	21	6	0	11	42	6	0	2	23	7	0	150	
4:25 PM	4	7	8	0	4	7	3	0	9	43	9	0	5	34	1	0	134	
4:30 PM	13	24	8	0	3	19	3	0	7	36	6	0	5	16	4	0	144	
4:35 PM	8	19	5	0	4	23	14	0	11	32	6	0	16	23	3	0	164	
4:40 PM	6	15	9	0	4	29	8	0	13	28	7	0	10	24	3	0	156	
4:45 PM	3	17	10	0	5	17	8	0	8	47	3	0	11	32	2	0	163	
4:50 PM	13	11	3	0	2	18	7	0	2	38	4	0	6	24	4	0	132	
4:55 PM	3	9	7	0	6	13	6	0	10	37	10	0	8	24	1	0	134	1754
5:00 PM	12	18	5	0	6	15	3	0	6	37	7	0	12	38	3	0	162	1771
5:05 PM	6	21	4	0	3	24	11	0	13	43	8	0	7	28	1	0	169	1808
5:10 PM	5	16	6	0	2	9	7	0	11	43	8	0	6	31	4	0	148	1804
5:15 PM	11	23	9	0	3	25	7	0	9	41	8	0	7	31	3	0	177	1833
5:20 PM	5	19	4	0	5	19	7	0	5	42	9	0	5	42	3	0	165	1848
5:25 PM	10	19	7	0	1	20	11	0	10	41	7	0	8	19	2	0	155	1869
5:30 PM	8	20	10	0	3	14	9	0	14	44	5	0	10	22	2	0	161	1886
5:35 PM	8	13	3	0	7	26	6	0	5	46	10	0	10	36	5	0	175	1897
5:40 PM	7	19	6	0	3	25	4	0	8	41	7	0	12	35	4	0	171	1912
5:45 PM	10	8	12	0	2	27	6	0	5	42	6	0	6	29	6	0	159	1908
5:50 PM	8	15	1	0	4	18	12	0	8	40	7	0	5	33	6	0	157	1933
5:55 PM	6	12	4	0	0	12	4	0	12	54	5	0	2	21	5	0	137	1936
Peak 15-Min Flowrates	Northbound				Southbound				Eastbound				Westbound				Total	
	Left	Thru	Right	U	Left	Thru	Right	U	Left	Thru	Right	U	Left	Thru	Right	U		
All Vehicles	92	208	76	0	52	260	76	0	108	524	88	0	128	372	44	0	2028	
Heavy Trucks	0	0	0	0	0	12	0	0	4	20	0	0	0	0	0	0	36	
Pedestrians		4				32				8				8			52	
Bicycles	0	0	0	0	0	0	0	0	0	0	0	0	0	0	0	0	0	
Railroad																		
Stopped Buses																		

Comments:

Total Vehicle Summary



Clay Carney
(503) 833-2740



SE Linwood Ave & SE Harmony Rd

Wednesday, October 11, 2006

4:00 PM to 6:00 PM

5-Minute Interval Summary

4:00 PM to 6:00 PM

Interval Start Time	Northbound SE Linwood Ave				Southbound SE Linwood Ave				Eastbound SE Harmony Rd				Westbound SE Harmony Rd				Interval Total	Pedestrians Crosswalk			
	L	T	R	Bikes	L	T	R	Bikes	L	T	R	Bikes	L	T	R	Bikes		North	South	East	West
4:00 PM	5	25	40	0	8	16	0	0	1	23	5	0	28	25	13	0	189	0	0	0	0
4:05 PM	3	26	47	0	4	12	2	0	2	20	5	0	33	17	6	0	177	0	0	0	0
4:10 PM	6	24	47	0	3	26	2	0	4	13	2	0	35	20	11	0	193	0	0	2	0
4:15 PM	6	18	40	0	8	29	1	0	2	20	8	0	26	22	9	0	189	1	1	1	0
4:20 PM	15	16	52	0	4	15	0	0	9	21	1	0	20	30	10	0	193	0	0	9	0
4:25 PM	1	15	29	0	8	19	0	0	2	15	1	0	18	24	6	0	138	0	1	1	0
4:30 PM	4	21	28	0	20	35	0	0	3	20	4	0	20	35	7	0	197	0	1	0	0
4:35 PM	2	27	43	0	9	14	2	0	3	18	10	0	30	26	10	0	194	0	0	0	0
4:40 PM	5	21	26	0	5	17	0	0	5	12	0	0	27	21	5	0	144	0	0	0	0
4:45 PM	2	15	16	0	15	31	2	0	2	16	7	0	22	22	12	1	162	1	1	0	1
4:50 PM	4	20	71	0	2	37	2	0	3	10	5	0	29	26	5	0	214	0	0	0	0
4:55 PM	5	22	44	0	11	29	4	0	2	22	6	0	28	35	9	0	217	0	0	0	0
5:00 PM	3	14	34	0	5	12	2	0	10	28	5	0	22	34	8	0	177	2	0	0	0
5:05 PM	6	20	39	0	13	22	3	0	1	19	4	0	26	10	4	0	167	2	0	0	0
5:10 PM	3	16	53	0	10	15	1	0	7	27	10	0	48	36	13	0	239	2	0	0	0
5:15 PM	5	37	44	0	6	37	3	0	5	16	2	0	31	26	4	0	216	1	0	1	0
5:20 PM	1	18	41	0	10	40	3	0	1	22	11	0	29	31	9	0	216	3	0	0	1
5:25 PM	3	31	63	0	10	25	2	0	3	25	7	0	27	24	15	0	235	0	0	4	1
5:30 PM	6	15	53	0	9	30	0	0	3	33	4	0	14	23	9	0	199	0	0	2	0
5:35 PM	4	18	44	0	1	21	1	0	3	21	4	0	35	23	9	0	184	2	0	0	0
5:40 PM	3	16	50	0	10	27	1	0	4	21	2	0	17	12	0	0	163	3	0	0	0
5:45 PM	7	18	35	0	12	27	1	0	0	24	9	0	22	27	14	0	196	0	3	2	0
5:50 PM	6	25	39	0	8	15	0	0	3	23	8	0	39	30	16	0	212	1	0	0	0
5:55 PM	4	27	44	0	7	24	5	0	0	19	4	0	36	19	13	0	202	0	1	0	0
Total Survey	109	505	1,022	0	198	575	37	0	78	488	124	0	662	598	217	1	4,613	18	8	22	3

15-Minute Interval Summary

4:00 PM to 6:00 PM

Interval Start Time	Northbound SE Linwood Ave				Southbound SE Linwood Ave				Eastbound SE Harmony Rd				Westbound SE Harmony Rd				Interval Total	Pedestrians Crosswalk			
	L	T	R	Bikes	L	T	R	Bikes	L	T	R	Bikes	L	T	R	Bikes		North	South	East	West
4:00 PM	14	75	134	0	15	54	4	0	7	56	12	0	96	62	30	0	559	0	0	2	0
4:15 PM	22	49	121	0	20	63	1	0	13	56	10	0	64	76	25	0	520	1	2	11	0
4:30 PM	11	69	97	0	34	66	2	0	11	50	14	0	77	82	22	0	535	0	1	0	0
4:45 PM	11	57	131	0	28	97	8	0	7	48	18	0	79	83	26	1	593	1	1	0	1
5:00 PM	12	50	126	0	28	49	6	0	18	74	19	0	96	80	25	0	583	6	0	0	0
5:15 PM	9	86	148	0	26	102	8	0	9	63	20	0	87	81	28	0	667	4	0	5	2
5:30 PM	13	49	147	0	20	78	2	0	10	75	10	0	66	58	18	0	546	5	0	2	0
5:45 PM	17	70	118	0	27	66	6	0	3	66	21	0	97	76	43	0	610	1	4	2	0
Total Survey	109	505	1,022	0	198	575	37	0	78	488	124	0	662	598	217	1	4,613	18	8	22	3

Peak Hour Summary

4:50 PM to 5:50 PM

By Approach	Northbound SE Linwood Ave				Southbound SE Linwood Ave				Eastbound SE Harmony Rd				Westbound SE Harmony Rd				Total	Pedestrians Crosswalk			
	In	Out	Total	Bikes	In	Out	Total	Bikes	In	Out	Total	Bikes	In	Out	Total	Bikes		North	South	East	West
Volume	866	719	1,585	0	444	386	830	0	379	380	759	0	734	938	1,672	0	2,423	15	3	9	2
%HV	2.0%				2.0%				1.3%				1.5%				1.7%				
PHF	0.89				0.82				0.85				0.81				0.90				

By Movement	Northbound SE Linwood Ave				Southbound SE Linwood Ave				Eastbound SE Harmony Rd				Westbound SE Harmony Rd				Total
	L	T	R	Total	L	T	R	Total	L	T	R	Total	L	T	R	Total	
Volume	50	245	571	866	99	322	23	444	42	268	69	379	328	307	99	734	2,423
%HV	2.0%	2.0%	1.9%	2.0%	2.0%	2.2%	0.0%	2.0%	0.0%	1.5%	1.4%	1.3%	1.2%	1.0%	4.0%	1.5%	1.7%
PHF	0.89	0.71	0.89	0.89	0.85	0.79	0.64	0.82	0.58	0.84	0.75	0.85	0.76	0.81	0.75	0.81	0.90

Rolling Hour Summary

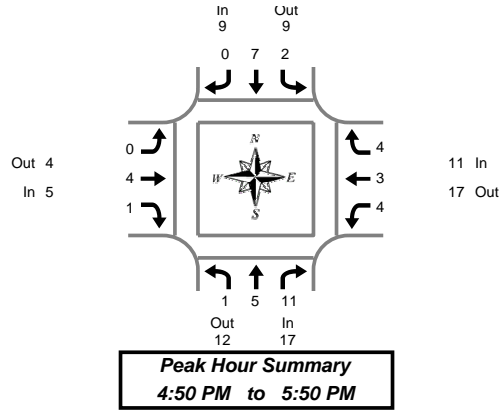
4:00 PM to 6:00 PM

Interval Start Time	Northbound SE Linwood Ave				Southbound SE Linwood Ave				Eastbound SE Harmony Rd				Westbound SE Harmony Rd				Interval Total	Pedestrians Crosswalk			
	L	T	R	Bikes	L	T	R	Bikes	L	T	R	Bikes	L	T	R	Bikes		North	South	East	West
4:00 PM	58	250	483	0	97	280	15	0	38	210	54	0	316	303	103	1	2,207	2	4	13	1
4:15 PM	56	225	475	0	110	275	17	0	49	228	61	0	316	321	98	1	2,231	8	4	11	1
4:30 PM	43	262	502	0	116	314	24	0	45	235	71	0	339	326	101	1	2,378	11	2	5	3
4:45 PM	45	242	552	0	102	326	24	0	44	260	67	0	328	302	97	1	2,389	16	1	7	3
5:00 PM	51	255	539	0	101	295	22	0	40	278	70	0	346	295	114	0	2,406	16	4	9	2

Heavy Vehicle Summary



Clay Carney
(503) 833-2740



SE Linwood Ave & SE Harmony Rd

Wednesday, October 11, 2006

4:00 PM to 6:00 PM

Peak Hour Summary
4:50 PM to 5:50 PM

Heavy Vehicle 5-Minute Interval Summary 4:00 PM to 6:00 PM

Interval Start Time	Northbound SE Linwood Ave				Southbound SE Linwood Ave				Eastbound SE Harmony Rd				Westbound SE Harmony Rd				Interval Total
	L	T	R	Total	L	T	R	Total	L	T	R	Total	L	T	R	Total	
4:00 PM	0	1	1	2	0	2	0	2	0	0	0	0	0	1	0	1	5
4:05 PM	1	4	4	9	0	1	0	1	0	0	0	0	0	0	2	2	12
4:10 PM	0	4	1	5	0	2	0	2	0	1	1	2	1	0	0	1	10
4:15 PM	0	0	0	0	0	1	0	1	0	0	1	1	0	0	0	0	2
4:20 PM	0	0	0	0	0	0	0	0	1	0	0	1	1	0	1	2	3
4:25 PM	0	0	1	1	0	2	0	2	0	0	0	0	1	0	0	1	4
4:30 PM	1	2	0	3	1	4	0	5	0	0	0	0	1	0	0	1	9
4:35 PM	0	1	0	1	0	2	0	2	0	1	0	1	2	0	0	2	6
4:40 PM	0	0	0	0	0	0	0	0	0	0	0	0	0	0	1	1	1
4:45 PM	0	1	1	2	1	1	0	2	0	1	1	2	0	0	0	0	6
4:50 PM	0	1	1	2	0	3	0	3	0	0	0	0	0	0	0	0	5
4:55 PM	0	0	0	0	0	0	0	0	0	2	1	3	0	0	0	0	3
5:00 PM	0	1	2	3	1	2	0	3	0	0	0	0	0	1	0	1	7
5:05 PM	0	0	1	1	0	1	0	1	0	0	0	0	0	0	1	1	3
5:10 PM	0	1	1	2	0	0	0	0	0	0	0	0	0	0	0	0	2
5:15 PM	0	0	1	1	0	0	0	0	0	0	0	0	0	0	0	0	1
5:20 PM	0	0	0	0	0	0	0	0	0	1	0	1	1	1	0	2	3
5:25 PM	0	0	0	0	0	0	0	0	0	1	0	1	1	0	1	2	3
5:30 PM	0	0	0	0	0	0	0	0	0	0	0	0	1	0	0	1	1
5:35 PM	0	1	1	2	0	1	0	1	0	0	0	0	0	0	0	0	3
5:40 PM	0	0	3	3	0	0	0	0	0	0	0	0	0	1	0	1	4
5:45 PM	1	1	1	3	1	0	0	1	0	0	0	0	1	0	2	3	7
5:50 PM	0	1	0	1	0	0	0	0	0	1	0	1	0	0	0	0	2
5:55 PM	0	0	0	0	0	0	0	0	0	0	0	0	0	0	0	0	0
Total Survey	3	19	19	41	4	22	0	26	1	8	4	13	10	4	8	22	102

Heavy Vehicle 15-Minute Interval Summary 4:00 PM to 6:00 PM

Interval Start Time	Northbound SE Linwood Ave				Southbound SE Linwood Ave				Eastbound SE Harmony Rd				Westbound SE Harmony Rd				Interval Total
	L	T	R	Total	L	T	R	Total	L	T	R	Total	L	T	R	Total	
4:00 PM	1	9	6	16	0	5	0	5	0	1	1	2	1	1	2	4	27
4:15 PM	0	0	1	1	0	3	0	3	1	0	1	2	2	0	1	3	9
4:30 PM	1	3	0	4	1	6	0	7	0	1	0	1	3	0	1	4	16
4:45 PM	0	2	2	4	1	4	0	5	0	3	2	5	0	0	0	0	14
5:00 PM	0	2	4	6	1	3	0	4	0	0	0	0	0	1	1	2	12
5:15 PM	0	0	1	1	0	0	0	0	0	2	0	2	2	1	1	4	7
5:30 PM	0	1	4	5	0	1	0	1	0	0	0	0	1	1	0	2	8
5:45 PM	1	2	1	4	1	0	0	1	0	1	0	1	1	0	2	3	9
Total Survey	3	19	19	41	4	22	0	26	1	8	4	13	10	4	8	22	102

Heavy Vehicle Peak Hour Summary 4:50 PM to 5:50 PM

By Approach	Northbound SE Linwood Ave			Southbound SE Linwood Ave			Eastbound SE Harmony Rd			Westbound SE Harmony Rd			Total
	In	Out	Total	In	Out	Total	In	Out	Total	In	Out	Total	
Volume	17	12	29	9	9	18	5	4	9	11	17	28	42
PHF	0.53			0.38			0.42			0.55			0.70

By Movement	Northbound SE Linwood Ave				Southbound SE Linwood Ave				Eastbound SE Harmony Rd				Westbound SE Harmony Rd				Total
	L	T	R	Total	L	T	R	Total	L	T	R	Total	L	T	R	Total	
Volume	1	5	11	17	2	7	0	9	0	4	1	5	4	3	4	11	42
PHF	0.25	0.63	0.55	0.53	0.50	0.35	0.00	0.38	0.00	0.50	0.25	0.42	0.33	0.75	0.50	0.55	0.70

Heavy Vehicle Rolling Hour Summary 4:00 PM to 6:00 PM

Interval Start Time	Northbound SE Linwood Ave				Southbound SE Linwood Ave				Eastbound SE Harmony Rd				Westbound SE Harmony Rd				Interval Total
	L	T	R	Total	L	T	R	Total	L	T	R	Total	L	T	R	Total	
4:00 PM	2	14	9	25	2	18	0	20	1	5	4	10	6	1	4	11	66
4:15 PM	1	7	7	15	3	16	0	19	1	4	3	8	5	1	3	9	51
4:30 PM	1	7	7	15	3	13	0	16	0	6	2	8	5	2	3	10	49
4:45 PM	0	5	11	16	2	8	0	10	0	5	2	7	3	3	2	8	41
5:00 PM	1	5	10	16	2	4	0	6	0	3	0	3	4	3	4	11	36

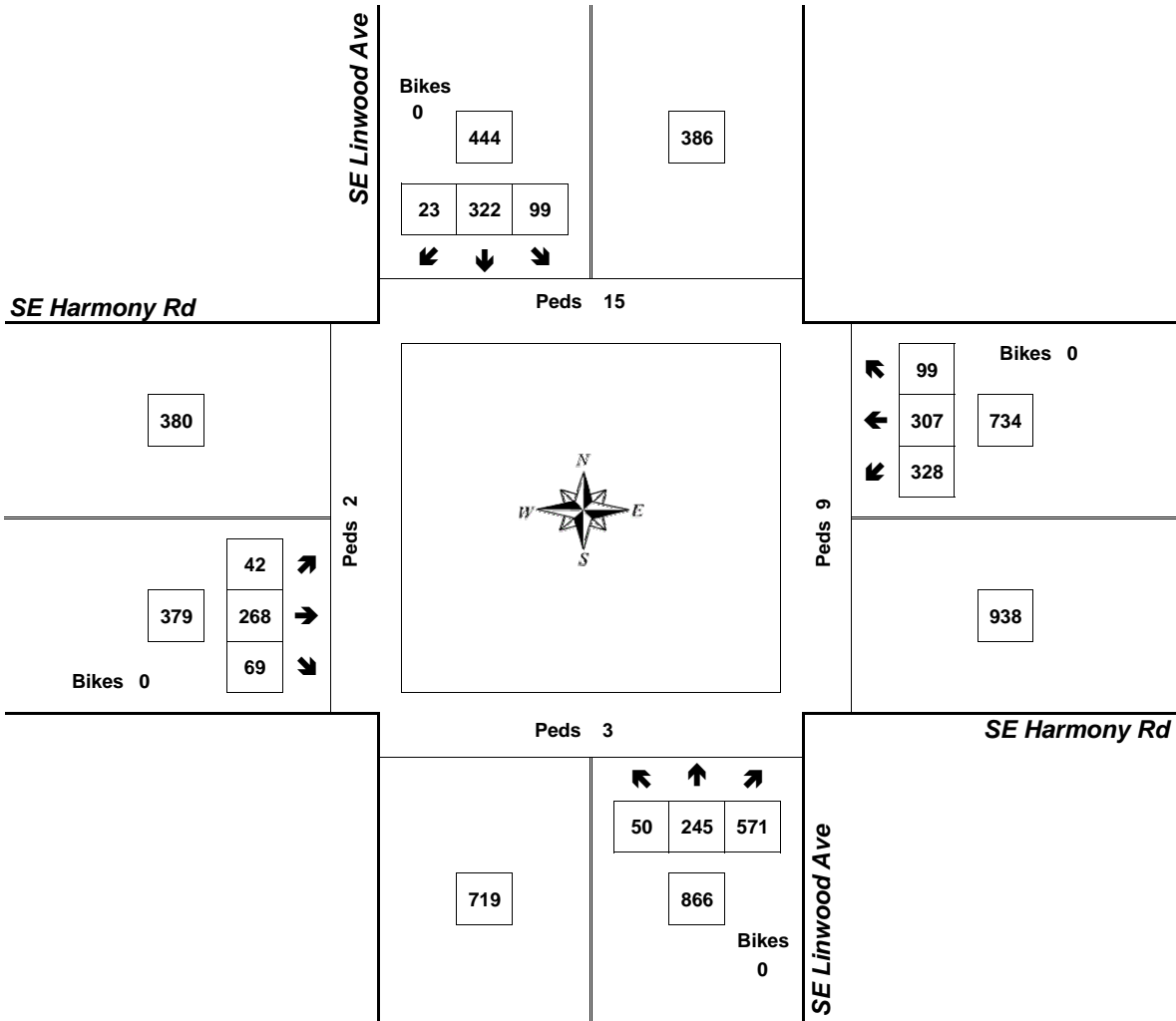
Peak Hour Summary



Clay Carney
(503) 833-2740

SE Linwood Ave & SE Harmony Rd

4:50 PM to 5:50 PM
Wednesday, October 11, 2006



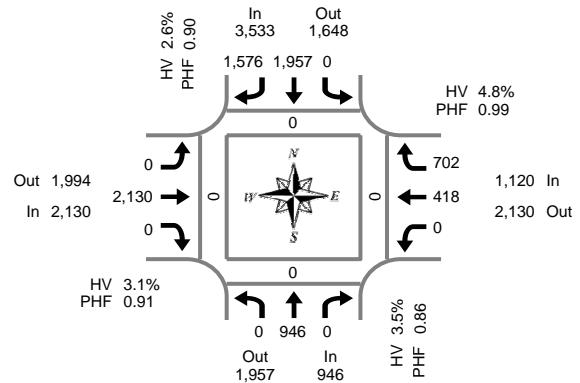
Approach	PHF	HV%	Volume
EB	0.85	1.3%	379
WB	0.81	1.5%	734
NB	0.89	2.0%	866
SB	0.82	2.0%	444
Intersection	0.90	1.7%	2,423

Count Period: 4:00 PM to 6:00 PM

Total Vehicle Summary



Clay Carney
(503) 833-2740



Hwy 99E & Hwy 224

Wednesday, December 06, 2006
3:00 PM to 6:00 PM

Peak Hour Summary
3:45 PM to 4:45 PM

15-Minute Interval Summary

3:00 PM to 6:00 PM

Interval Start Time	Northbound Hwy 99E				Southbound Hwy 99E				Eastbound Hwy 224				Westbound Hwy 224				Interval Total	Pedestrians Crosswalk			
	L	T	R	Bikes	L	T	R	Bikes	L	T	R	Bikes	L	T	R	Bikes		North	South	East	West
3:00 PM	0	166	0	0	0	337	181	0	0	295	0	0	0	89	127	0	0	0	0	0	0
3:15 PM	0	201	0	0	0	298	248	0	0	355	0	0	0	84	144	0	0	0	0	0	0
3:30 PM	0	183	0	0	0	400	330	0	0	350	0	0	0	97	152	0	0	0	0	0	0
3:45 PM	0	274	0	0	0	448	355	0	0	511	0	0	0	116	166	0	0	0	0	0	0
4:00 PM	0	244	0	0	0	538	443	0	0	585	0	0	0	112	165	0	0	0	0	0	0
4:15 PM	0	218	0	0	0	457	390	0	0	523	0	0	0	96	184	0	0	0	0	0	0
4:30 PM	0	210	0	0	0	514	388	0	0	511	0	0	0	94	187	0	0	0	0	0	0
4:45 PM	0	198	0	0	0	439	340	0	0	483	0	0	0	102	175	0	0	0	0	0	0
5:00 PM	0	237	0	0	0	494	367	0	0	336	0	0	0	110	177	0	0	0	0	0	0
5:15 PM	0	230	0	0	0	384	314	0	0	471	0	0	0	104	216	0	0	0	0	0	0
5:30 PM	0	212	0	0	0	487	336	0	0	503	0	0	0	90	175	0	0	0	0	0	0
5:45 PM	0	236	0	0	0	442	259	0	0	409	0	0	0	96	150	0	0	0	0	0	0
Total Survey	0	2,609	0	0	0	5,238	3,951	0	0	5,332	0	0	0	1,190	2,018	0	0	0	0	0	0

Peak Hour Summary

3:45 PM to 4:45 PM

By Approach	Northbound Hwy 99E				Southbound Hwy 99E				Eastbound Hwy 224				Westbound Hwy 224				Total	Pedestrians Crosswalk			
	In	Out	Total	Bikes	In	Out	Total	Bikes	In	Out	Total	Bikes	In	Out	Total	Bikes		North	South	East	West
Volume	946	1,957	2,903	0	3,533	1,648	5,181	0	2,130	1,994	4,124	0	1,120	2,130	3,250	0	7,729	0	0	0	0
%HV	3.5%				2.6%				3.1%				4.8%				3.2%				
PHF	0.86				0.90				0.91				0.99				0.93				

By Movement	Northbound Hwy 99E				Southbound Hwy 99E				Eastbound Hwy 224				Westbound Hwy 224				Total
	L	T	R	Total	L	T	R	Total	L	T	R	Total	L	T	R	Total	
Volume	0	946	0	946	0	1,957	1,576	3,533	0	2,130	0	2,130	0	418	702	1,120	7,729
%HV	0.0%	3.5%	0.0%	3.5%	0.0%	2.0%	3.4%	2.6%	0.0%	3.1%	0.0%	3.1%	0.0%	2.6%	6.1%	4.8%	3.2%
PHF	0.00	0.86	0.00	0.86	0.00	0.91	0.89	0.90	0.00	0.91	0.00	0.91	0.00	0.90	0.94	0.99	0.93

Rolling Hour Summary

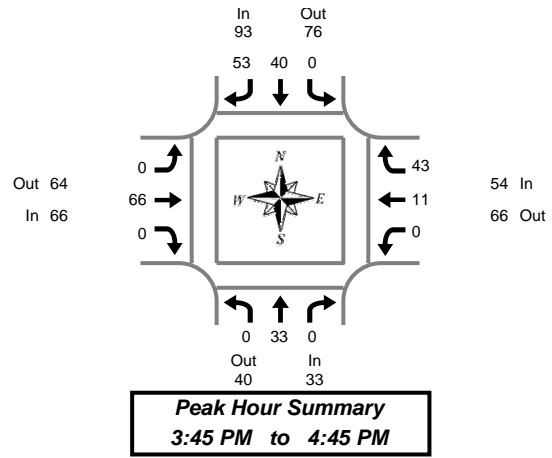
3:00 PM to 6:00 PM

Interval Start Time	Northbound Hwy 99E				Southbound Hwy 99E				Eastbound Hwy 224				Westbound Hwy 224				Interval Total	Pedestrians Crosswalk			
	L	T	R	Bikes	L	T	R	Bikes	L	T	R	Bikes	L	T	R	Bikes		North	South	East	West
3:00 PM	0	824	0	0	0	1,483	1,114	0	0	1,511	0	0	0	386	589	0	0	0	0	0	0
3:15 PM	0	902	0	0	0	1,684	1,376	0	0	1,801	0	0	0	409	627	0	0	0	0	0	0
3:30 PM	0	919	0	0	0	1,843	1,518	0	0	1,969	0	0	0	421	667	0	0	0	0	0	0
3:45 PM	0	946	0	0	0	1,957	1,576	0	0	2,130	0	0	0	418	702	0	0	0	0	0	0
4:00 PM	0	870	0	0	0	1,948	1,561	0	0	2,102	0	0	0	404	711	0	0	0	0	0	0
4:15 PM	0	863	0	0	0	1,904	1,485	0	0	1,853	0	0	0	402	723	0	0	0	0	0	0
4:30 PM	0	875	0	0	0	1,831	1,409	0	0	1,801	0	0	0	410	755	0	0	0	0	0	0
4:45 PM	0	877	0	0	0	1,804	1,357	0	0	1,793	0	0	0	406	743	0	0	0	0	0	0
5:00 PM	0	915	0	0	0	1,807	1,276	0	0	1,719	0	0	0	400	718	0	0	0	0	0	0

Heavy Vehicle Summary



Clay Carney
(503) 833-2740



Hwy 99E & Hwy 224

Wednesday, December 06, 2006
3:00 PM to 6:00 PM

Heavy Vehicle 15-Minute Interval Summary 3:00 PM to 6:00 PM

Interval Start Time	Northbound Hwy 99E				Southbound Hwy 99E				Eastbound Hwy 224				Westbound Hwy 224				Interval Total
	L	T	R	Total	L	T	R	Total	L	T	R	Total	L	T	R	Total	
3:00 PM	0	14	0	14	0	11	12	23	0	16	0	16	0	4	3	7	60
3:15 PM	0	12	0	12	0	12	20	32	0	25	0	25	0	3	9	12	81
3:30 PM	0	8	0	8	0	15	19	34	0	22	0	22	0	2	7	9	73
3:45 PM	0	11	0	11	0	13	12	25	0	18	0	18	0	5	10	15	69
4:00 PM	0	6	0	6	0	8	15	23	0	19	0	19	0	2	13	15	63
4:15 PM	0	8	0	8	0	11	15	26	0	16	0	16	0	1	11	12	62
4:30 PM	0	8	0	8	0	8	11	19	0	13	0	13	0	3	9	12	52
4:45 PM	0	9	0	9	0	7	7	14	0	10	0	10	0	2	8	10	43
5:00 PM	0	6	0	6	0	6	13	19	0	14	0	14	0	1	7	8	47
5:15 PM	0	4	0	4	0	7	7	14	0	11	0	11	0	1	5	6	35
5:30 PM	0	1	0	1	0	8	6	14	0	9	0	9	0	1	8	9	33
5:45 PM	0	3	0	3	0	16	15	31	0	17	0	17	0	2	9	11	62
Total Survey	0	90	0	90	0	122	152	274	0	190	0	190	0	27	99	126	680

Heavy Vehicle Peak Hour Summary 3:45 PM to 4:45 PM

By Approach	Northbound Hwy 99E			Southbound Hwy 99E			Eastbound Hwy 224			Westbound Hwy 224			Total
	In	Out	Total	In	Out	Total	In	Out	Total	In	Out	Total	
Volume	33	40	73	93	76	169	66	64	130	54	66	120	246
PHF	0.24			0.26			0.25			0.32			0.28

By Movement	Northbound Hwy 99E				Southbound Hwy 99E				Eastbound Hwy 224				Westbound Hwy 224				Total
	L	T	R	Total	L	T	R	Total	L	T	R	Total	L	T	R	Total	
Volume	0	33	0	33	0	40	53	93	0	66	0	66	0	11	43	54	246
PHF	0.00	0.24	0.00	0.24	0.00	0.25	0.26	0.26	0.00	0.25	0.00	0.25	0.00	0.28	0.32	0.32	0.28

Heavy Vehicle Rolling Hour Summary 3:00 PM to 6:00 PM

Interval Start Time	Northbound Hwy 99E				Southbound Hwy 99E				Eastbound Hwy 224				Westbound Hwy 224				Interval Total
	L	T	R	Total	L	T	R	Total	L	T	R	Total	L	T	R	Total	
3:00 PM	0	45	0	45	0	51	63	114	0	81	0	81	0	14	29	43	283
3:15 PM	0	37	0	37	0	48	66	114	0	84	0	84	0	12	39	51	286
3:30 PM	0	33	0	33	0	47	61	108	0	75	0	75	0	10	41	51	267
3:45 PM	0	33	0	33	0	40	53	93	0	66	0	66	0	11	43	54	246
4:00 PM	0	31	0	31	0	34	48	82	0	58	0	58	0	8	41	49	220
4:15 PM	0	31	0	31	0	32	46	78	0	53	0	53	0	7	35	42	204
4:30 PM	0	27	0	27	0	28	38	66	0	48	0	48	0	7	29	36	177
4:45 PM	0	20	0	20	0	28	33	61	0	44	0	44	0	5	28	33	158
5:00 PM	0	14	0	14	0	37	41	78	0	51	0	51	0	5	29	34	177

Peak Hour Summary

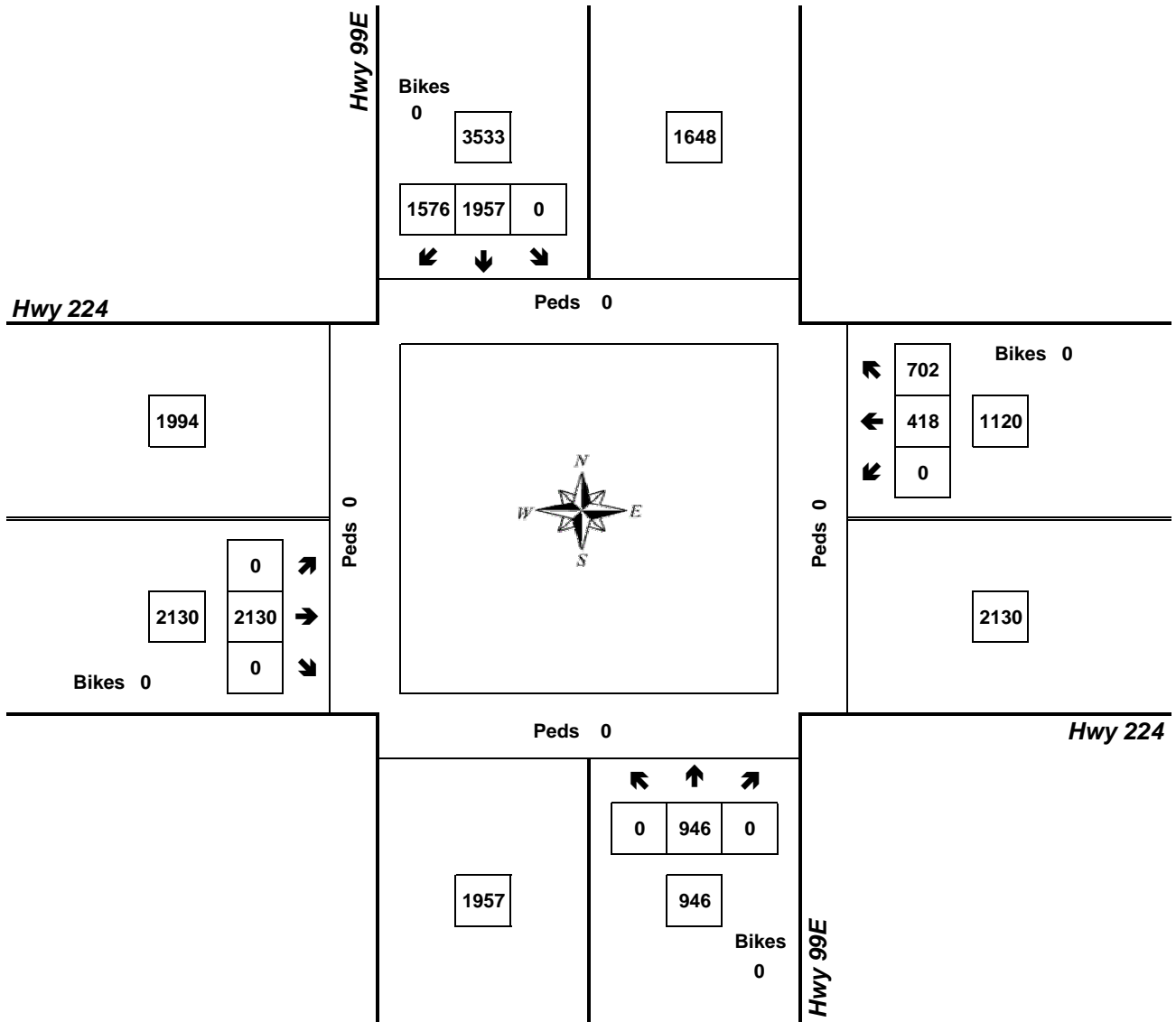


Clay Carney
(503) 833-2740

Hwy 99E & Hwy 224

3:45 PM to 4:45 PM

Wednesday, December 06, 2006



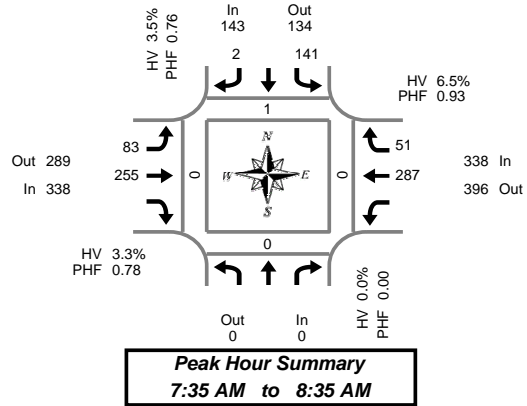
Approach	PHF	HV%	Volume
EB	0.91	3.1%	2,130
WB	0.99	4.8%	1,120
NB	0.86	3.5%	946
SB	0.90	2.6%	3,533
Intersection	0.93	3.2%	7,729

Count Period: 3:00 PM to 6:00 PM

Total Vehicle Summary



Clay Carney
(503) 833-2740



Hwy 212 EB Ramps & SE Lake Rd

Wednesday, October 11, 2006

7:00 AM to 9:00 AM

Peak Hour Summary
7:35 AM to 8:35 AM

5-Minute Interval Summary

7:00 AM to 9:00 AM

Interval Start Time	Northbound Hwy 212 EB Ramps				Southbound Hwy 212 EB Ramps				Eastbound SE Lake Rd			Westbound SE Lake Rd			Interval Total	Pedestrians Crosswalk			
	Bikes	L	R	Bikes	L	R	Bikes	L	T	Bikes	T	R	Bikes	North		South	East	West	
7:00 AM	0	8	0	0	12	12	0	17	3	0	52	0	0	0	0				
7:05 AM	0	5	0	0	7	8	0	10	1	0	31	0	0	0	0				
7:10 AM	0	5	2	0	12	15	0	13	6	0	53	0	0	0	0				
7:15 AM	0	10	0	0	7	15	0	14	2	0	48	0	0	0	0				
7:20 AM	0	10	0	0	11	16	0	15	1	0	53	0	0	0	0				
7:25 AM	0	8	0	0	11	15	0	28	1	0	63	0	0	0	0				
7:30 AM	0	16	0	0	7	7	0	28	1	0	59	0	0	0	0				
7:35 AM	0	11	0	0	4	24	0	31	7	0	77	0	0	0	0				
7:40 AM	0	21	0	0	10	22	0	22	5	0	80	0	0	0	0				
7:45 AM	0	13	0	0	9	35	0	21	4	0	82	0	0	0	0				
7:50 AM	0	13	0	0	6	27	0	25	3	0	74	0	0	0	0				
7:55 AM	0	16	0	0	3	18	0	25	4	0	66	0	0	0	0				
8:00 AM	0	10	1	0	6	17	0	24	4	0	62	0	0	0	0				
8:05 AM	0	5	0	0	5	12	0	26	2	0	50	0	0	0	0				
8:10 AM	0	13	0	0	5	22	0	23	3	0	66	0	0	0	0				
8:15 AM	0	6	1	0	9	21	0	13	5	0	55	1	0	0	0				
8:20 AM	0	13	0	0	7	24	0	22	4	0	70	0	0	0	0				
8:25 AM	0	9	0	0	9	22	0	28	4	0	72	0	0	0	0				
8:30 AM	0	11	0	0	10	11	0	27	6	0	65	0	0	0	0				
8:35 AM	0	10	0	0	7	28	0	13	2	0	60	0	0	0	0				
8:40 AM	0	12	0	0	4	20	0	19	3	0	58	0	0	0	0				
8:45 AM	0	9	0	0	7	24	0	30	6	0	76	0	0	0	0				
8:50 AM	0	3	1	0	11	18	0	22	2	0	57	0	0	0	0				
8:55 AM	0	10	3	0	6	25	0	24	2	0	70	0	0	0	0				
Total Survey	0	247	8	0	185	458	0	520	81	0	1,499	1	0	0	0				

15-Minute Interval Summary

7:00 AM to 9:00 AM

Interval Start Time	Northbound Hwy 212 EB Ramps				Southbound Hwy 212 EB Ramps				Eastbound SE Lake Rd			Westbound SE Lake Rd			Interval Total	Pedestrians Crosswalk			
	Bikes	L	R	Bikes	L	T	Bikes	L	T	Bikes	T	R	Bikes	North		South	East	West	
7:00 AM	0	18	2	0	31	35	0	40	10	0	136	0	0	0	0				
7:15 AM	0	28	0	0	29	46	0	57	4	0	164	0	0	0	0				
7:30 AM	0	48	0	0	21	53	0	81	13	0	216	0	0	0	0				
7:45 AM	0	42	0	0	18	80	0	71	11	0	222	0	0	0	0				
8:00 AM	0	28	1	0	16	51	0	73	9	0	178	0	0	0	0				
8:15 AM	0	28	1	0	25	67	0	63	13	0	197	1	0	0	0				
8:30 AM	0	33	0	0	21	59	0	59	11	0	183	0	0	0	0				
8:45 AM	0	22	4	0	24	67	0	76	10	0	203	0	0	0	0				
Total Survey	0	247	8	0	185	458	0	520	81	0	1,499	1	0	0	0				

Peak Hour Summary

7:35 AM to 8:35 AM

By Approach	Northbound Hwy 212 EB Ramps				Southbound Hwy 212 EB Ramps				Eastbound SE Lake Rd			Westbound SE Lake Rd			Total	Pedestrians Crosswalk					
	In	Out	Total	Bikes	In	Out	Total	Bikes	In	Out	Total	Bikes	In	Out		Total	North	South	East	West	
Volume	0	0	0	0	143	134	277	0	338	289	627	0	338	396	734	0	819	1	0	0	0
%HV	0.0%				3.5%				3.3%			6.5%			4.6%						
PHF	0.00				0.76				0.78			0.93			0.86						

By Movement	Northbound Hwy 212 EB Ramps				Southbound Hwy 212 EB Ramps				Eastbound SE Lake Rd			Westbound SE Lake Rd			Total					
	Total	L	R	Total	L	T	Total	T	R	Total	T	R	Total							
Volume	0	141	2	143	83	255	338	287	51	338	819									
%HV	NA	NA	NA	0.0%	3.5%	NA	0.0%	3.5%	3.6%	3.1%	NA	3.3%	NA	6.3%	7.8%	6.5%	4.6%			
PHF		0.00	0.75	0.50	0.76	0.80	0.76	0.78	0.93	0.80	0.93	0.86								

Rolling Hour Summary

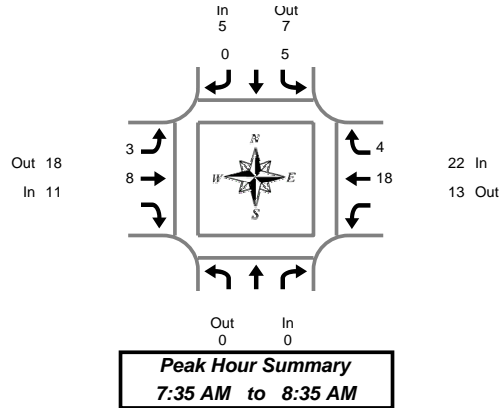
7:00 AM to 9:00 AM

Interval Start Time	Northbound Hwy 212 EB Ramps				Southbound Hwy 212 EB Ramps				Eastbound SE Lake Rd			Westbound SE Lake Rd			Interval Total	Pedestrians Crosswalk			
	Bikes	L	R	Bikes	L	T	Bikes	L	T	Bikes	T	R	Bikes	North		South	East	West	
7:00 AM	0	136	2	0	99	214	0	249	38	0	738	0	0	0	0				
7:15 AM	0	146	1	0	84	230	0	282	37	0	780	0	0	0	0				
7:30 AM	0	146	2	0	80	251	0	288	46	0	813	1	0	0	0				
7:45 AM	0	131	2	0	80	257	0	266	44	0	780	1	0	0	0				
8:00 AM	0	111	6	0	86	244	0	271	43	0	761	1	0	0	0				

Heavy Vehicle Summary



Clay Carney
(503) 833-2740



Hwy 212 EB Ramps & SE Lake Rd

Wednesday, October 11, 2006

7:00 AM to 9:00 AM

Heavy Vehicle 5-Minute Interval Summary 7:00 AM to 9:00 AM

Interval Start Time	Northbound Hwy 212 EB Ramps			Southbound Hwy 212 EB Ramps			Eastbound SE Lake Rd			Westbound SE Lake Rd			Interval Total
	Total	L	R	Total	L	R	Total	T	Total	T	R	Total	
7:00 AM	0	1	0	1	2	0	2	0	2	4	1	5	8
7:05 AM	0	0	0	0	2	0	2	0	2	1	0	1	3
7:10 AM	0	0	0	0	0	0	0	0	0	0	0	0	0
7:15 AM	0	1	0	1	0	0	0	0	0	2	0	2	3
7:20 AM	0	0	0	0	0	0	0	0	0	5	1	6	6
7:25 AM	0	1	0	1	0	1	1	1	1	4	0	4	6
7:30 AM	0	1	0	1	0	2	2	2	2	2	0	2	5
7:35 AM	0	0	0	0	0	1	1	1	1	2	0	2	3
7:40 AM	0	0	0	0	0	0	0	0	0	0	0	0	0
7:45 AM	0	0	0	0	0	0	0	0	0	2	0	2	2
7:50 AM	0	0	0	0	0	0	0	0	0	0	2	2	2
7:55 AM	0	0	0	0	0	0	0	0	0	1	0	1	1
8:00 AM	0	1	0	1	0	0	0	0	0	1	0	1	2
8:05 AM	0	2	0	2	0	2	2	2	2	1	0	1	5
8:10 AM	0	0	0	0	0	0	0	0	0	0	0	0	0
8:15 AM	0	0	0	0	1	0	1	1	1	0	0	0	1
8:20 AM	0	1	0	1	0	1	1	1	1	3	1	4	6
8:25 AM	0	0	0	0	0	0	1	1	1	5	0	5	6
8:30 AM	0	1	0	1	2	3	5	5	5	3	1	4	10
8:35 AM	0	1	0	1	2	1	3	3	3	1	0	1	5
8:40 AM	0	0	0	0	1	1	2	2	2	0	1	1	3
8:45 AM	0	0	0	0	1	1	2	2	2	0	1	1	3
8:50 AM	0	0	0	0	4	0	4	4	4	0	0	0	4
8:55 AM	0	1	0	1	1	1	2	2	2	0	0	0	3
Total Survey	0	11	0	11	16	15	31	31	31	37	8	45	87

Heavy Vehicle 15-Minute Interval Summary 7:00 AM to 9:00 AM

Interval Start Time	Northbound Hwy 212 EB Ramps			Southbound Hwy 212 EB Ramps			Eastbound SE Lake Rd			Westbound SE Lake Rd			Interval Total
	Total	L	R	Total	L	R	Total	T	Total	T	R	Total	
7:00 AM	0	1	0	1	4	0	4	0	4	5	1	6	11
7:15 AM	0	2	0	2	0	1	1	1	1	11	1	12	15
7:30 AM	0	1	0	1	0	3	3	3	3	4	0	4	8
7:45 AM	0	0	0	0	0	0	0	0	0	3	2	5	5
8:00 AM	0	3	0	3	0	2	2	2	2	2	0	2	7
8:15 AM	0	1	0	1	1	2	3	3	3	8	1	9	13
8:30 AM	0	2	0	2	5	5	10	10	10	4	2	6	18
8:45 AM	0	1	0	1	6	2	8	8	8	0	1	1	10
Total Survey	0	11	0	11	16	15	31	31	31	37	8	45	87

Heavy Vehicle Peak Hour Summary 7:35 AM to 8:35 AM

By Approach	Northbound Hwy 212 EB Ramps			Southbound Hwy 212 EB Ramps			Eastbound SE Lake Rd			Westbound SE Lake Rd			Total
	In	Out	Total	In	Out	Total	In	Out	Total	In	Out	Total	
Volume	0	0	0	5	7	12	11	18	29	22	13	35	38
PHF	0.00			0.42			0.39			0.42			0.43

By Movement	Northbound Hwy 212 EB Ramps			Southbound Hwy 212 EB Ramps			Eastbound SE Lake Rd			Westbound SE Lake Rd			Total
	Total	L	R	Total	L	R	Total	T	Total	T	R	Total	
Volume	0	5	0	5	3	8	11	18	29	11	4	15	38
PHF	0.00	0.42	0.00	0.42	0.38	0.40	0.39			0.41	0.50	0.42	0.43

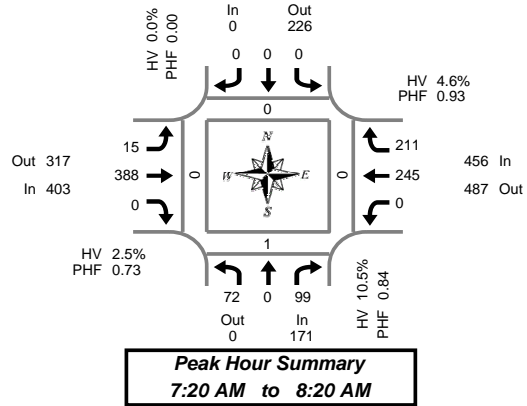
Heavy Vehicle Rolling Hour Summary 7:00 AM to 9:00 AM

Interval Start Time	Northbound Hwy 212 EB Ramps			Southbound Hwy 212 EB Ramps			Eastbound SE Lake Rd			Westbound SE Lake Rd			Interval Total
	Total	L	R	Total	L	R	Total	T	Total	T	R	Total	
7:00 AM	0	4	0	4	4	4	8	4	8	23	4	27	39
7:15 AM	0	6	0	6	0	6	6	6	6	20	3	23	35
7:30 AM	0	5	0	5	1	7	8	7	8	17	3	20	33
7:45 AM	0	6	0	6	6	9	15	9	15	17	5	22	43
8:00 AM	0	7	0	7	12	11	23	11	23	14	4	18	48

Total Vehicle Summary



Clay Carney
(503) 833-2740



Hwy 212 WB Ramps & SE Lake Rd

Wednesday, October 11, 2006

7:00 AM to 9:00 AM

5-Minute Interval Summary

7:00 AM to 9:00 AM

Interval Start Time	Northbound Hwy 212 WB Ramps				Southbound Hwy 212 WB Ramps				Eastbound SE Lake Rd				Westbound SE Lake Rd				Interval Total	Pedestrians Crosswalk			
	L	T	R	Bikes	L	T	R	Bikes	L	T	R	Bikes	L	T	R	Bikes		North	South	East	West
7:00 AM	7	0	9	0	0	0	0	0	1	24	0	0	0	12	13	0	66	0	0	0	0
7:05 AM	1	0	10	0	0	0	0	0	1	12	0	0	0	9	23	0	56	0	0	0	0
7:10 AM	5	0	9	0	0	0	0	0	0	14	0	0	0	16	7	0	51	0	0	0	0
7:15 AM	4	0	6	0	0	0	0	0	1	30	0	0	0	10	21	0	72	0	0	0	0
7:20 AM	2	0	14	0	0	0	0	0	0	28	0	0	0	18	28	0	90	0	0	0	0
7:25 AM	5	0	8	0	0	0	0	0	2	21	0	0	0	21	16	0	73	0	0	0	0
7:30 AM	11	0	9	0	0	0	0	0	2	25	0	0	0	16	18	0	81	0	0	0	0
7:35 AM	8	0	8	0	0	0	0	0	0	34	0	0	0	28	23	1	101	0	0	0	0
7:40 AM	9	0	6	0	0	0	0	0	0	39	0	0	0	23	11	0	88	0	0	0	0
7:45 AM	4	0	7	0	0	0	0	0	1	56	0	0	0	15	14	0	97	0	0	0	0
7:50 AM	6	0	13	0	0	0	0	0	3	36	0	0	0	20	14	0	92	0	0	0	0
7:55 AM	4	0	8	0	0	0	0	0	2	40	0	0	0	24	14	0	92	0	1	0	0
8:00 AM	10	0	8	0	0	0	0	0	1	27	0	0	0	20	16	1	82	0	0	0	0
8:05 AM	8	0	8	0	0	0	0	0	2	21	0	0	0	19	18	0	76	0	0	0	0
8:10 AM	3	0	4	0	0	0	0	0	1	29	0	0	0	24	22	0	83	0	0	0	0
8:15 AM	2	0	6	0	0	0	0	0	1	32	0	0	0	17	17	0	75	0	0	0	0
8:20 AM	1	0	3	0	0	0	0	0	1	35	0	0	0	24	8	0	72	0	0	0	0
8:25 AM	6	0	7	0	0	0	0	0	1	34	0	0	0	27	14	0	89	0	0	0	0
8:30 AM	6	0	5	0	0	0	0	0	2	21	0	0	0	28	20	0	82	0	0	0	0
8:35 AM	3	0	10	0	0	0	0	0	1	35	0	0	0	19	10	0	78	0	0	0	0
8:40 AM	4	0	3	0	0	0	0	0	1	32	0	0	0	13	7	0	60	0	0	0	0
8:45 AM	8	0	5	0	0	0	0	0	2	27	0	0	0	27	6	0	75	0	0	0	0
8:50 AM	5	0	6	0	0	0	0	0	1	33	0	0	0	18	17	0	80	0	0	0	0
8:55 AM	12	0	9	0	0	0	0	0	1	27	0	0	0	14	12	0	75	0	0	0	0
Total Survey	134	0	181	0	0	0	0	0	28	712	0	0	0	462	369	2	1,886	0	1	0	0

15-Minute Interval Summary

7:00 AM to 9:00 AM

Interval Start Time	Northbound Hwy 212 WB Ramps				Southbound Hwy 212 WB Ramps				Eastbound SE Lake Rd				Westbound SE Lake Rd				Interval Total	Pedestrians Crosswalk			
	L	T	R	Bikes	L	T	R	Bikes	L	T	R	Bikes	L	T	R	Bikes		North	South	East	West
7:00 AM	13	0	28	0	0	0	0	0	2	50	0	0	0	37	43	0	173	0	0	0	0
7:15 AM	11	0	28	0	0	0	0	0	3	79	0	0	0	49	65	0	235	0	0	0	0
7:30 AM	28	0	23	0	0	0	0	0	2	98	0	0	0	67	52	1	270	0	0	0	0
7:45 AM	14	0	28	0	0	0	0	0	6	132	0	0	0	59	42	0	281	0	1	0	0
8:00 AM	21	0	20	0	0	0	0	0	4	77	0	0	0	63	56	1	241	0	0	0	0
8:15 AM	9	0	16	0	0	0	0	0	3	101	0	0	0	68	39	0	236	0	0	0	0
8:30 AM	13	0	18	0	0	0	0	0	4	88	0	0	0	60	37	0	220	0	0	0	0
8:45 AM	25	0	20	0	0	0	0	0	4	87	0	0	0	59	35	0	230	0	0	0	0
Total Survey	134	0	181	0	0	0	0	0	28	712	0	0	0	462	369	2	1,886	0	1	0	0

Peak Hour Summary

7:20 AM to 8:20 AM

By Approach	Northbound Hwy 212 WB Ramps				Southbound Hwy 212 WB Ramps				Eastbound SE Lake Rd				Westbound SE Lake Rd				Total	Pedestrians Crosswalk			
	In	Out	Total	Bikes	In	Out	Total	Bikes	In	Out	Total	Bikes	In	Out	Total	Bikes		North	South	East	West
Volume	171	0	171	0	0	226	226	0	403	317	720	0	456	487	943	2	1,030	0	1	0	0
%HV	10.5%				0.0%				2.5%				4.6%				4.8%				
PHF	0.84				0.00				0.73				0.93				0.90				

By Movement	Northbound Hwy 212 WB Ramps				Southbound Hwy 212 WB Ramps				Eastbound SE Lake Rd				Westbound SE Lake Rd				Total				
	L	T	R	Total	L	T	R	Total	L	T	R	Total	L	T	R	Total					
Volume	72	0	99	171	0	0	0	0	15	388	0	403	0	245	211	456	1,030				
%HV	9.7%	0.0%	11.1%	10.5%	0.0%	0.0%	0.0%	0.0%	0.0%	2.6%	0.0%	2.5%	0.0%	5.3%	3.8%	4.6%	4.8%				
PHF	0.64	0.00	0.80	0.84	0.00	0.00	0.00	0.00	0.63	0.73	0.00	0.73	0.00	0.91	0.85	0.93	0.90				

Rolling Hour Summary

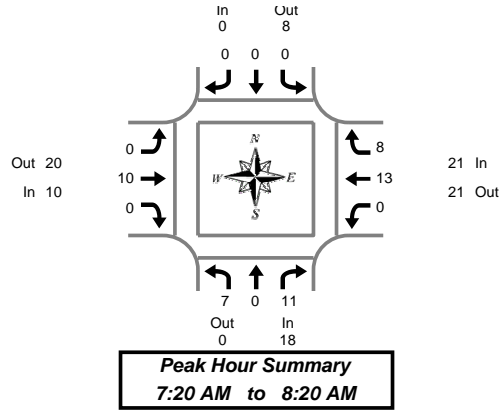
7:00 AM to 9:00 AM

Interval Start Time	Northbound Hwy 212 WB Ramps				Southbound Hwy 212 WB Ramps				Eastbound SE Lake Rd				Westbound SE Lake Rd				Interval Total	Pedestrians Crosswalk			
	L	T	R	Bikes	L	T	R	Bikes	L	T	R	Bikes	L	T	R	Bikes		North	South	East	West
7:00 AM	66	0	107	0	0	0	0	0	13	359	0	0	0	212	202	1	959	0	1	0	0
7:15 AM	74	0	99	0	0	0	0	0	15	386	0	0	0	238	215	2	1,027	0	1	0	0
7:30 AM	72	0	87	0	0	0	0	0	15	408	0	0	0	257	189	2	1,028	0	1	0	0
7:45 AM	57	0	82	0	0	0	0	0	17	398	0	0	0	250	174	1	978	0	1	0	0
8:00 AM	68	0	74	0	0	0	0	0	15	353	0	0	0	250	167	1	927	0	0	0	0

Heavy Vehicle Summary



Clay Carney
(503) 833-2740



Hwy 212 WB Ramps & SE Lake Rd

Wednesday, October 11, 2006

7:00 AM to 9:00 AM

Heavy Vehicle 5-Minute Interval Summary

7:00 AM to 9:00 AM

Interval Start Time	Northbound Hwy 212 WB Ramps				Southbound Hwy 212 WB Ramps				Eastbound SE Lake Rd				Westbound SE Lake Rd				Interval Total
	L	T	R	Total	L	T	R	Total	L	T	R	Total	L	T	R	Total	
7:00 AM	3	0	0	3	0	0	0	0	0	1	0	1	0	1	0	1	5
7:05 AM	1	0	3	4	0	0	0	0	0	0	0	0	0	0	0	0	4
7:10 AM	0	0	2	2	0	0	0	0	0	0	0	0	0	0	0	0	2
7:15 AM	1	0	1	2	0	0	0	0	0	1	0	1	0	1	1	2	5
7:20 AM	2	0	2	4	0	0	0	0	0	0	0	0	0	5	0	5	9
7:25 AM	2	0	2	4	0	0	0	0	0	2	0	2	0	1	1	2	8
7:30 AM	0	0	1	1	0	0	0	0	0	3	0	3	0	2	3	5	9
7:35 AM	2	0	1	3	0	0	0	0	0	0	0	0	0	0	1	1	4
7:40 AM	0	0	0	0	0	0	0	0	0	0	0	0	0	1	1	1	1
7:45 AM	0	0	0	0	0	0	0	0	0	0	0	0	0	1	0	1	1
7:50 AM	0	0	0	0	0	0	0	0	0	0	0	0	0	2	0	2	2
7:55 AM	0	0	2	2	0	0	0	0	0	0	0	0	0	1	0	1	3
8:00 AM	1	0	1	2	0	0	0	0	0	1	0	1	0	0	1	1	4
8:05 AM	0	0	0	0	0	0	0	0	0	4	0	4	0	1	0	1	5
8:10 AM	0	0	2	2	0	0	0	0	0	0	0	0	0	0	1	1	3
8:15 AM	0	0	0	0	0	0	0	0	0	0	0	0	0	0	0	0	0
8:20 AM	0	0	1	1	0	0	0	0	0	0	0	0	0	4	0	4	5
8:25 AM	1	0	1	2	0	0	0	0	0	1	0	1	0	4	1	5	8
8:30 AM	1	0	2	3	0	0	0	0	0	3	0	3	0	4	2	6	12
8:35 AM	0	0	1	1	0	0	0	0	0	3	0	3	0	1	0	1	5
8:40 AM	0	0	1	1	0	0	0	0	0	2	0	2	0	1	0	1	4
8:45 AM	0	0	1	1	0	0	0	0	0	1	0	1	0	1	1	2	4
8:50 AM	0	0	4	4	0	0	0	0	0	0	0	0	0	0	0	0	4
8:55 AM	0	0	1	1	0	0	0	0	0	2	0	2	0	0	2	2	5
Total Survey	14	0	29	43	0	0	0	0	0	24	0	24	0	30	15	45	112

Heavy Vehicle 15-Minute Interval Summary

7:00 AM to 9:00 AM

Interval Start Time	Northbound Hwy 212 WB Ramps				Southbound Hwy 212 WB Ramps				Eastbound SE Lake Rd				Westbound SE Lake Rd				Interval Total
	L	T	R	Total	L	T	R	Total	L	T	R	Total	L	T	R	Total	
7:00 AM	4	0	5	9	0	0	0	0	0	1	0	1	0	1	0	1	11
7:15 AM	5	0	5	10	0	0	0	0	0	3	0	3	0	7	2	9	22
7:30 AM	2	0	2	4	0	0	0	0	0	3	0	3	0	2	5	7	14
7:45 AM	0	0	2	2	0	0	0	0	0	0	0	0	0	4	0	4	6
8:00 AM	1	0	3	4	0	0	0	0	0	5	0	5	0	1	2	3	12
8:15 AM	1	0	2	3	0	0	0	0	0	1	0	1	0	8	1	9	13
8:30 AM	1	0	4	5	0	0	0	0	0	8	0	8	0	6	2	8	21
8:45 AM	0	0	6	6	0	0	0	0	0	3	0	3	0	1	3	4	13
Total Survey	14	0	29	43	0	0	0	0	0	24	0	24	0	30	15	45	112

Heavy Vehicle Peak Hour Summary

7:20 AM to 8:20 AM

By Approach	Northbound Hwy 212 WB Ramps			Southbound Hwy 212 WB Ramps			Eastbound SE Lake Rd			Westbound SE Lake Rd			Total
	In	Out	Total	In	Out	Total	In	Out	Total	In	Out	Total	
Volume	18	0	18	0	8	8	10	20	30	21	21	42	49
PHF	0.50			0.00			0.50			0.44			0.47

By Movement	Northbound Hwy 212 WB Ramps				Southbound Hwy 212 WB Ramps				Eastbound SE Lake Rd				Westbound SE Lake Rd				Total
	L	T	R	Total	L	T	R	Total	L	T	R	Total	L	T	R	Total	
Volume	7	0	11	18	0	0	0	0	0	10	0	10	0	13	8	21	49
PHF	0.44	0.00	0.55	0.50	0.00	0.00	0.00	0.00	0.00	0.50	0.00	0.50	0.00	0.41	0.40	0.44	0.47

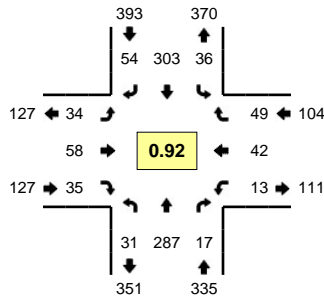
Heavy Vehicle Rolling Hour Summary

7:00 AM to 9:00 AM

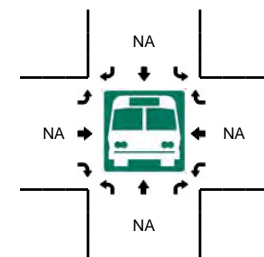
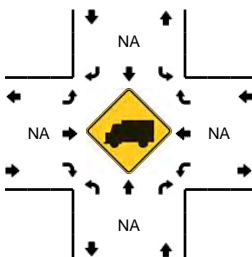
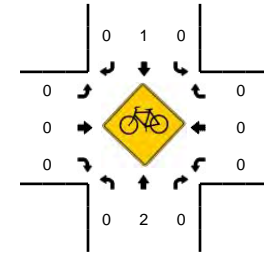
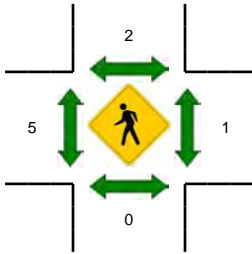
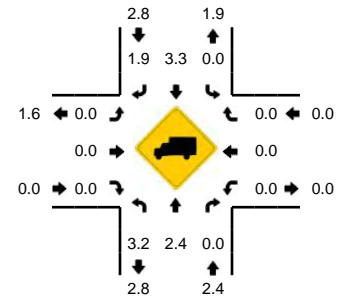
Interval Start Time	Northbound Hwy 212 WB Ramps				Southbound Hwy 212 WB Ramps				Eastbound SE Lake Rd				Westbound SE Lake Rd				Interval Total
	L	T	R	Total	L	T	R	Total	L	T	R	Total	L	T	R	Total	
7:00 AM	11	0	14	25	0	0	0	0	0	7	0	7	0	14	7	21	53
7:15 AM	8	0	12	20	0	0	0	0	0	11	0	11	0	14	9	23	54
7:30 AM	4	0	9	13	0	0	0	0	0	9	0	9	0	15	8	23	45
7:45 AM	3	0	11	14	0	0	0	0	0	14	0	14	0	19	5	24	52
8:00 AM	3	0	15	18	0	0	0	0	0	17	0	17	0	16	8	24	59

LOCATION: Linwood Ave -- Monroe St
CITY/STATE: Milwaukie, OR

QC JOB #: 10776903
DATE: Tue, Jun 12 2012



Peak-Hour: 5:00 PM -- 6:00 PM
Peak 15-Min: 5:15 PM -- 5:30 PM

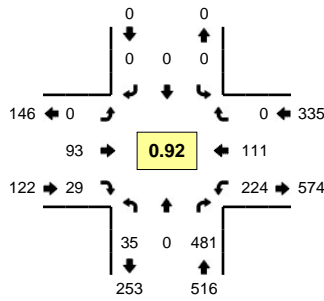


5-Min Count Period Beginning At	Linwood Ave (Northbound)				Linwood Ave (Southbound)				Monroe St (Eastbound)				Monroe St (Westbound)				Total	Hourly Totals
	Left	Thru	Right	U	Left	Thru	Right	U	Left	Thru	Right	U	Left	Thru	Right	U		
4:00 PM	2	25	2	0	3	15	4	0	4	4	2	0	1	3	3	0	68	
4:05 PM	2	25	1	0	5	19	7	0	3	3	4	0	2	1	1	0	73	
4:10 PM	3	28	2	0	2	17	3	0	1	1	4	0	2	5	4	0	72	
4:15 PM	4	26	5	0	4	26	3	0	4	6	3	0	1	2	3	0	87	
4:20 PM	2	21	4	0	3	16	8	0	4	3	2	0	1	2	6	0	72	
4:25 PM	4	19	2	0	3	16	2	0	4	3	3	0	0	2	3	0	61	
4:30 PM	3	37	3	0	3	30	6	0	1	5	5	0	2	6	8	0	109	
4:35 PM	1	16	1	0	4	34	4	0	4	2	5	0	2	5	1	0	79	
4:40 PM	2	23	2	0	5	36	2	0	1	2	5	0	2	2	1	0	83	
4:45 PM	1	28	0	0	2	21	4	0	5	1	4	0	4	2	1	0	73	
4:50 PM	0	26	2	0	2	25	5	0	0	2	2	0	0	2	2	0	68	
4:55 PM	2	16	3	0	2	18	5	0	1	3	4	0	0	0	0	0	54	899
5:00 PM	1	27	1	0	5	20	5	0	4	5	2	0	0	1	6	0	77	908
5:05 PM	4	23	4	0	3	30	7	0	2	6	3	0	1	1	2	0	86	921
5:10 PM	1	27	1	0	0	17	2	0	1	3	6	0	2	5	2	0	67	916
5:15 PM	1	26	1	0	2	28	5	0	2	4	3	0	1	5	12	0	90	919
5:20 PM	3	37	1	0	4	25	2	0	1	3	2	0	1	4	4	0	87	934
5:25 PM	3	20	2	0	3	31	4	0	4	5	3	0	1	2	5	0	83	956
5:30 PM	4	25	3	0	5	17	7	0	4	9	2	0	0	4	3	0	83	930
5:35 PM	1	29	0	0	2	35	4	0	8	3	1	0	1	3	2	0	89	940
5:40 PM	2	12	2	0	4	33	5	0	2	3	3	0	0	2	4	0	72	929
5:45 PM	7	21	0	0	5	26	4	0	3	10	5	0	3	1	2	0	87	943
5:50 PM	1	17	2	0	2	27	5	0	1	3	0	0	2	5	3	0	68	943
5:55 PM	3	23	0	0	1	14	4	0	2	4	5	0	1	9	4	0	70	959
Peak 15-Min Flowrates	Northbound				Southbound				Eastbound				Westbound				Total	
All Vehicles	28	332	16	0	36	336	44	0	28	48	32	0	12	44	84	0	1040	
Heavy Trucks	4	12	0		0	20	0		0	0	0		0	0	0		36	
Pedestrians		0				8				4				0			12	
Bicycles	0	0	0		0	0	0		0	0	0		0	0	0		0	
Railroad																		
Stopped Buses																		

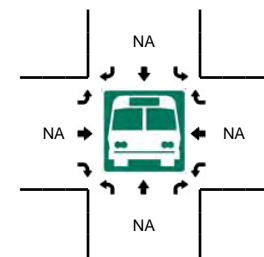
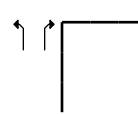
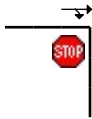
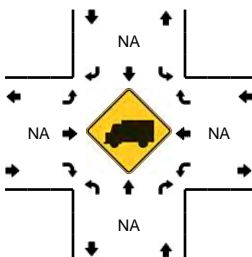
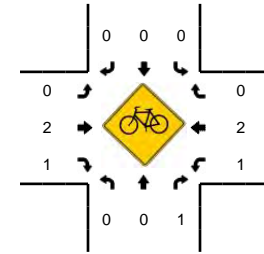
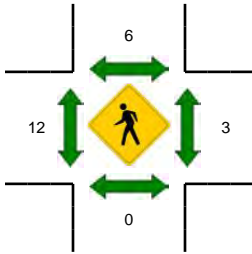
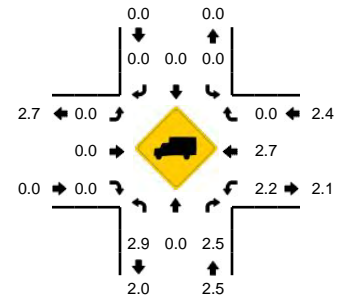
Comments:

LOCATION: 42nd Ave -- King Rd
CITY/STATE: Milwaukie, OR

QC JOB #: 10776901
DATE: Tue, Jun 12 2012



Peak-Hour: 4:55 PM -- 5:55 PM
Peak 15-Min: 5:05 PM -- 5:20 PM



5-Min Count Period Beginning At	42nd Ave (Northbound)				42nd Ave (Southbound)				King Rd (Eastbound)				King Rd (Westbound)				Total	Hourly Totals
	Left	Thru	Right	U	Left	Thru	Right	U	Left	Thru	Right	U	Left	Thru	Right	U		
4:00 PM	3	0	31	0	0	0	0	0	0	6	0	0	20	4	0	0	64	
4:05 PM	1	0	33	0	0	0	0	0	0	15	4	0	18	3	0	0	74	
4:10 PM	2	0	40	0	0	0	0	0	0	8	2	0	20	6	0	0	78	
4:15 PM	0	0	39	0	0	0	0	0	0	3	0	0	14	1	0	0	57	
4:20 PM	4	0	35	0	0	0	0	0	0	5	1	0	23	3	0	0	71	
4:25 PM	6	0	39	0	0	0	0	0	0	4	1	0	23	4	0	0	77	
4:30 PM	2	0	41	0	0	0	0	0	0	9	7	0	15	2	0	0	76	
4:35 PM	2	0	36	0	0	0	0	0	0	8	0	0	14	4	0	0	64	
4:40 PM	1	0	45	0	0	0	0	0	0	9	2	0	19	6	0	0	82	
4:45 PM	2	0	34	0	0	0	0	0	0	7	3	0	21	8	0	0	75	
4:50 PM	1	0	32	0	0	0	0	0	0	11	1	0	20	8	0	0	73	
4:55 PM	1	0	38	0	0	0	0	0	0	11	6	0	10	7	0	0	73	864
5:00 PM	4	0	27	0	0	0	0	0	0	6	3	0	16	14	0	0	70	870
5:05 PM	5	0	44	0	0	0	0	0	0	10	1	0	14	13	0	0	87	883
5:10 PM	2	0	55	0	0	0	0	0	0	7	4	0	15	5	0	0	88	893
5:15 PM	0	0	45	0	0	0	0	0	0	5	3	0	20	16	0	0	89	925
5:20 PM	4	0	35	0	0	0	0	0	0	8	0	0	30	8	0	0	85	939
5:25 PM	4	0	36	0	0	0	0	0	0	8	3	0	13	7	0	0	71	933
5:30 PM	2	0	45	0	0	0	0	0	0	7	4	0	17	9	0	0	84	941
5:35 PM	5	0	34	0	0	0	0	0	0	6	2	0	23	7	0	0	77	954
5:40 PM	5	0	38	0	0	0	0	0	0	7	1	0	22	7	0	0	80	952
5:45 PM	2	0	40	0	0	0	0	0	0	7	2	0	21	5	0	0	77	954
5:50 PM	1	0	44	0	0	0	0	0	0	11	0	0	23	13	0	0	92	973
5:55 PM	1	0	37	0	0	0	0	0	0	6	1	0	8	6	0	0	59	959
Peak 15-Min Flowrates	Northbound				Southbound				Eastbound				Westbound				Total	
	Left	Thru	Right	U	Left	Thru	Right	U	Left	Thru	Right	U	Left	Thru	Right	U		
All Vehicles	28	0	576	0	0	0	0	0	0	88	32	0	196	136	0	0	1056	
Heavy Trucks	0	0	8	0	0	0	0	0	0	0	0	0	0	4	0	0	12	
Pedestrians			0				0					0			4		4	
Bicycles	0	0	0		0	0	0			0	2	0	1	1	0		4	
Railroad																		
Stopped Buses																		

Comments:

Start Time	07-Dec-06 Thu	NB	SB	Total
12:00 AM		0	1	1
12:15		0	0	0
12:30		0	0	0
12:45		0	1	1
01:00		0	0	0
01:15		0	1	1
01:30		0	1	1
01:45		0	0	0
02:00		0	0	0
02:15		0	0	0
02:30		1	1	2
02:45		0	0	0
03:00		0	0	0
03:15		0	0	0
03:30		0	1	1
03:45		0	0	0
04:00		0	1	1
04:15		0	0	0
04:30		0	1	1
04:45		0	0	0
05:00		2	2	4
05:15		0	0	0
05:30		4	0	4
05:45		1	2	3
06:00		1	1	2
06:15		2	0	2
06:30		2	2	4
06:45		5	2	7
07:00		2	3	5
07:15		7	2	9
07:30		4	7	11
07:45		5	5	10
08:00		7	16	23
08:15		6	12	18
08:30		2	4	6
08:45		1	8	9
09:00		8	10	18
09:15		4	5	9
09:30		3	4	7
09:45		1	3	4
10:00		6	9	15
10:15		2	6	8
10:30		2	4	6
10:45		6	4	10
11:00		5	6	11
11:15		4	5	9
11:30		8	3	11
11:45		2	7	9
Total		103	140	243
Percent		42.4%	57.6%	
Peak		07:15	07:30	07:30
Vol.		23	40	62
P.H.F.		0.719	0.625	0.674

Start Time	07-Dec-06 Thu	NB	SB	Total
12:00 PM		9	4	13
12:15		8	9	17
12:30		6	6	12
12:45		3	6	9
01:00		2	7	9
01:15		2	3	5
01:30		5	9	14
01:45		9	6	15
02:00		7	8	15
02:15		6	6	12
02:30		5	6	11
02:45		5	10	15
03:00		5	3	8
03:15		4	12	16
03:30		6	13	19
03:45		6	16	22
04:00		11	10	21
04:15		1	10	11
04:30		7	8	15
04:45		4	10	14
05:00		4	17	21
05:15		6	12	18
05:30		4	4	8
05:45		8	10	18
06:00		4	8	12
06:15		9	13	22
06:30		4	12	16
06:45		6	10	16
07:00		3	7	10
07:15		2	2	4
07:30		6	4	10
07:45		3	9	12
08:00		2	5	7
08:15		0	7	7
08:30		4	3	7
08:45		2	2	4
09:00		2	5	7
09:15		3	3	6
09:30		5	3	8
09:45		1	2	3
10:00		2	1	3
10:15		0	3	3
10:30		1	5	6
10:45		0	3	3
11:00		0	0	0
11:15		0	0	0
11:30		0	0	0
11:45		0	2	2
Total		192	314	506
Percent		37.9%	62.1%	
Peak		13:30	15:15	15:15
Vol.		27	51	78
P.H.F.		0.614	0.750	0.886
Grand Total		295	454	749
Percent		39.4%	60.6%	
ADT		Not Calculated		

Start Time	07-Dec-06 Thu	NB	SB	Total
12:00 AM		0	1	1
12:15		2	0	2
12:30		0	0	0
12:45		0	0	0
01:00		0	0	0
01:15		1	1	2
01:30		0	0	0
01:45		0	2	2
02:00		0	1	1
02:15		0	0	0
02:30		1	0	1
02:45		0	0	0
03:00		0	0	0
03:15		0	0	0
03:30		0	0	0
03:45		0	0	0
04:00		0	0	0
04:15		0	0	0
04:30		0	0	0
04:45		0	0	0
05:00		1	1	2
05:15		0	0	0
05:30		2	1	3
05:45		1	0	1
06:00		1	1	2
06:15		3	0	3
06:30		3	0	3
06:45		3	2	5
07:00		6	2	8
07:15		3	0	3
07:30		3	3	6
07:45		7	4	11
08:00		2	5	7
08:15		2	2	4
08:30		7	3	10
08:45		5	4	9
09:00		1	1	2
09:15		2	2	4
09:30		1	0	1
09:45		0	1	1
10:00		4	1	5
10:15		2	3	5
10:30		0	0	0
10:45		0	1	1
11:00		2	6	8
11:15		2	4	6
11:30		4	5	9
11:45		8	4	12
Total		79	61	140
Percent		56.4%	43.6%	
Peak		07:00	11:00	11:00
Vol.		19	19	35
P.H.F.		0.594	0.792	0.729

Start Time	07-Dec-06 Thu	NB	SB	Total
12:00 PM		0	4	4
12:15		3	3	6
12:30		2	8	10
12:45		5	5	10
01:00		2	2	4
01:15		3	6	9
01:30		4	4	8
01:45		4	4	8
02:00		2	2	4
02:15		5	4	9
02:30		3	7	10
02:45		5	8	13
03:00		2	5	7
03:15		6	8	14
03:30		3	4	7
03:45		4	12	16
04:00		2	1	3
04:15		2	7	9
04:30		2	4	6
04:45		1	5	6
05:00		5	8	13
05:15		2	4	6
05:30		0	0	0
05:45		2	9	11
06:00		6	6	12
06:15		0	7	7
06:30		5	5	10
06:45		1	6	7
07:00		1	3	4
07:15		0	2	2
07:30		1	1	2
07:45		2	3	5
08:00		0	4	4
08:15		1	2	3
08:30		0	1	1
08:45		4	6	10
09:00		4	2	6
09:15		1	3	4
09:30		2	3	5
09:45		1	2	3
10:00		1	1	2
10:15		0	2	2
10:30		0	1	1
10:45		0	1	1
11:00		0	0	0
11:15		0	0	0
11:30		1	0	1
11:45		0	1	1
Total		100	186	286
Percent		35.0%	65.0%	
Peak		14:30	15:00	14:30
Vol.		16	29	44
P.H.F.		0.667	0.604	0.688
Grand Total		179	247	426
Percent		42.0%	58.0%	
ADT		Not Calculated		

Start Time	07-Dec-06 Thu	NB	SB	Total
12:00 AM		0	0	0
12:15		1	1	2
12:30		0	0	0
12:45		0	0	0
01:00		0	0	0
01:15		0	0	0
01:30		1	1	2
01:45		0	0	0
02:00		1	1	2
02:15		0	0	0
02:30		1	1	2
02:45		0	0	0
03:00		1	0	1
03:15		0	0	0
03:30		0	0	0
03:45		0	0	0
04:00		0	1	1
04:15		0	0	0
04:30		0	0	0
04:45		2	0	2
05:00		0	0	0
05:15		0	0	0
05:30		1	1	2
05:45		1	1	2
06:00		0	0	0
06:15		2	2	4
06:30		2	4	6
06:45		5	3	8
07:00		2	3	5
07:15		4	3	7
07:30		5	7	12
07:45		4	7	11
08:00		5	1	6
08:15		12	10	22
08:30		8	14	22
08:45		7	6	13
09:00		4	2	6
09:15		1	2	3
09:30		2	2	4
09:45		3	3	6
10:00		2	4	6
10:15		3	1	4
10:30		5	4	9
10:45		4	4	8
11:00		2	3	5
11:15		1	1	2
11:30		5	4	9
11:45		10	7	17
Total		107	104	211
Percent		50.7%	49.3%	
Peak		08:00	07:45	08:00
Vol.		32	32	63
P.H.F.		0.667	0.571	0.716

Start Time	07-Dec-06 Thu	NB	SB	Total
12:00 PM		2	3	5
12:15		5	5	10
12:30		5	3	8
12:45		2	1	3
01:00		4	4	8
01:15		4	5	9
01:30		2	4	6
01:45		5	4	9
02:00		2	3	5
02:15		12	10	22
02:30		6	4	10
02:45		8	6	14
03:00		2	10	12
03:15		6	8	14
03:30		9	6	15
03:45		4	1	5
04:00		9	6	15
04:15		4	8	12
04:30		6	8	14
04:45		5	8	13
05:00		6	10	16
05:15		2	6	8
05:30		4	2	6
05:45		6	4	10
06:00		4	2	6
06:15		4	5	9
06:30		2	3	5
06:45		4	2	6
07:00		3	2	5
07:15		10	12	22
07:30		1	1	2
07:45		0	2	2
08:00		2	2	4
08:15		7	3	10
08:30		1	1	2
08:45		2	2	4
09:00		3	2	5
09:15		2	3	5
09:30		3	3	6
09:45		1	0	1
10:00		1	0	1
10:15		0	0	0
10:30		0	0	0
10:45		2	1	3
11:00		1	0	1
11:15		0	1	1
11:30		3	1	4
11:45		3	1	4
Total		179	178	357
Percent		50.1%	49.9%	
Peak		14:00	16:15	14:15
Vol.		28	34	58
P.H.F.		0.583	0.708	0.659
Grand Total		286	282	568
Percent		50.4%	49.6%	
ADT		Not Calculated		

Start Time	07-Dec-06 Thu	NB	SB	Total
12:00 AM		0	0	0
12:15		1	2	3
12:30		0	0	0
12:45		2	2	4
01:00		0	0	0
01:15		1	2	3
01:30		2	2	4
01:45		0	2	2
02:00		0	0	0
02:15		0	0	0
02:30		0	0	0
02:45		0	0	0
03:00		0	0	0
03:15		0	0	0
03:30		0	0	0
03:45		0	0	0
04:00		0	1	1
04:15		0	0	0
04:30		0	0	0
04:45		0	0	0
05:00		1	0	1
05:15		0	0	0
05:30		0	0	0
05:45		1	1	2
06:00		1	2	3
06:15		2	0	2
06:30		0	0	0
06:45		2	0	2
07:00		4	3	7
07:15		8	5	13
07:30		4	4	8
07:45		10	9	19
08:00		7	10	17
08:15		10	14	24
08:30		7	12	19
08:45		5	5	10
09:00		7	1	8
09:15		3	5	8
09:30		1	1	2
09:45		6	6	12
10:00		3	6	9
10:15		3	2	5
10:30		4	1	5
10:45		4	3	7
11:00		6	4	10
11:15		3	4	7
11:30		2	4	6
11:45		6	2	8
Total		116	115	231
Percent		50.2%	49.8%	
Peak		07:45	07:45	07:45
Vol.		34	45	79
P.H.F.		0.850	0.804	0.823

Start Time	07-Dec-06 Thu	NB	SB	Total
12:00 PM		4	4	8
12:15		8	6	14
12:30		4	5	9
12:45		7	8	15
01:00		7	8	15
01:15		8	5	13
01:30		8	6	14
01:45		3	2	5
02:00		4	4	8
02:15		8	10	18
02:30		7	6	13
02:45		4	6	10
03:00		4	8	12
03:15		15	8	23
03:30		13	7	20
03:45		10	9	19
04:00		2	6	8
04:15		13	10	23
04:30		2	3	5
04:45		6	9	15
05:00		8	6	14
05:15		8	7	15
05:30		8	7	15
05:45		8	8	16
06:00		9	8	17
06:15		11	5	16
06:30		5	3	8
06:45		2	6	8
07:00		6	5	11
07:15		4	4	8
07:30		4	4	8
07:45		1	1	2
08:00		5	1	6
08:15		1	0	1
08:30		5	2	7
08:45		3	5	8
09:00		4	4	8
09:15		3	0	3
09:30		2	3	5
09:45		1	1	2
10:00		0	0	0
10:15		0	1	1
10:30		1	2	3
10:45		0	1	1
11:00		0	0	0
11:15		0	0	0
11:30		0	0	0
11:45		2	2	4
Total		238	216	454
Percent		52.4%	47.6%	
Peak		15:00	15:00	15:00
Vol.		42	32	74
P.H.F.		0.700	0.800	0.804
Grand Total		354	331	685
Percent		51.7%	48.3%	
ADT		Not Calculated		

Start Time	07-Dec-06 Thu	EB	WB	Total
12:00 AM		0	0	0
12:15		1	2	3
12:30		0	1	1
12:45		0	0	0
01:00		0	0	0
01:15		1	2	3
01:30		1	0	1
01:45		0	0	0
02:00		0	0	0
02:15		1	0	1
02:30		0	0	0
02:45		0	0	0
03:00		0	1	1
03:15		0	0	0
03:30		1	0	1
03:45		0	0	0
04:00		1	0	1
04:15		0	0	0
04:30		1	0	1
04:45		0	0	0
05:00		3	3	6
05:15		0	0	0
05:30		0	0	0
05:45		0	0	0
06:00		3	1	4
06:15		2	2	4
06:30		6	6	12
06:45		2	2	4
07:00		7	4	11
07:15		6	6	12
07:30		1	2	3
07:45		4	4	8
08:00		4	1	5
08:15		2	2	4
08:30		4	4	8
08:45		5	1	6
09:00		1	0	1
09:15		2	0	2
09:30		0	1	1
09:45		5	5	10
10:00		1	2	3
10:15		0	1	1
10:30		4	5	9
10:45		2	2	4
11:00		5	2	7
11:15		1	1	2
11:30		2	3	5
11:45		2	3	5
Total		81	69	150
Percent		54.0%	46.0%	
Peak		06:30	06:30	06:30
Vol.		21	18	39
P.H.F.		0.750	0.750	0.813

Start Time	07-Dec-06 Thu	EB	WB	Total
12:00 PM		1	4	5
12:15		1	2	3
12:30		6	4	10
12:45		2	4	6
01:00		5	6	11
01:15		4	2	6
01:30		2	2	4
01:45		1	2	3
02:00		6	4	10
02:15		7	6	13
02:30		5	0	5
02:45		5	2	7
03:00		4	5	9
03:15		2	3	5
03:30		6	2	8
03:45		2	4	6
04:00		7	5	12
04:15		6	4	10
04:30		2	5	7
04:45		7	7	14
05:00		5	3	8
05:15		6	7	13
05:30		3	1	4
05:45		6	7	13
06:00		4	1	5
06:15		5	1	6
06:30		5	3	8
06:45		4	3	7
07:00		2	3	5
07:15		3	1	4
07:30		5	2	7
07:45		0	3	3
08:00		1	0	1
08:15		3	2	5
08:30		1	3	4
08:45		1	2	3
09:00		2	2	4
09:15		4	4	8
09:30		4	4	8
09:45		1	0	1
10:00		2	0	2
10:15		1	1	2
10:30		2	2	4
10:45		0	0	0
11:00		2	0	2
11:15		0	0	0
11:30		1	1	2
11:45		0	1	1
Total		154	130	284
Percent		54.2%	45.8%	
Peak		14:00	16:30	16:00
Vol.		23	22	43
P.H.F.		0.821	0.786	0.768
Grand Total		235	199	434
Percent		54.1%	45.9%	
ADT		Not Calculated		

Start Time	07-Dec-06 Thu	EB	WB	Total
12:00 AM		0	0	0
12:15		0	0	0
12:30		0	0	0
12:45		0	0	0
01:00		0	0	0
01:15		0	0	0
01:30		0	0	0
01:45		0	0	0
02:00		0	0	0
02:15		0	0	0
02:30		0	0	0
02:45		0	0	0
03:00		0	0	0
03:15		0	0	0
03:30		0	0	0
03:45		1	1	2
04:00		0	0	0
04:15		0	0	0
04:30		0	0	0
04:45		1	1	2
05:00		1	1	2
05:15		0	0	0
05:30		0	0	0
05:45		0	0	0
06:00		0	0	0
06:15		0	0	0
06:30		1	1	2
06:45		1	1	2
07:00		3	4	7
07:15		1	2	3
07:30		3	4	7
07:45		8	11	19
08:00		3	2	5
08:15		4	4	8
08:30		0	0	0
08:45		2	2	4
09:00		4	2	6
09:15		5	2	7
09:30		2	2	4
09:45		2	4	6
10:00		2	3	5
10:15		1	1	2
10:30		2	3	5
10:45		2	2	4
11:00		2	2	4
11:15		3	2	5
11:30		2	1	3
11:45		1	1	2
Total		57	59	116
Percent		49.1%	50.9%	
Peak		07:30	07:00	07:30
Vol.		18	21	39
P.H.F.		0.563	0.477	0.513

Start Time	07-Dec-06 Thu	EB	WB	Total
12:00 PM		2	1	3
12:15		2	3	5
12:30		1	1	2
12:45		2	3	5
01:00		2	2	4
01:15		4	4	8
01:30		5	5	10
01:45		0	0	0
02:00		1	3	4
02:15		6	6	12
02:30		8	6	14
02:45		4	4	8
03:00		3	2	5
03:15		4	2	6
03:30		3	4	7
03:45		2	3	5
04:00		8	10	18
04:15		8	9	17
04:30		3	3	6
04:45		5	7	12
05:00		2	2	4
05:15		3	4	7
05:30		3	7	10
05:45		3	4	7
06:00		5	5	10
06:15		6	4	10
06:30		2	3	5
06:45		0	0	0
07:00		3	4	7
07:15		3	2	5
07:30		0	0	0
07:45		4	3	7
08:00		3	3	6
08:15		2	3	5
08:30		1	1	2
08:45		2	3	5
09:00		2	2	4
09:15		0	2	2
09:30		2	3	5
09:45		0	0	0
10:00		0	0	0
10:15		1	0	1
10:30		0	0	0
10:45		1	1	2
11:00		0	0	0
11:15		0	0	0
11:30		1	1	2
11:45		0	0	0
Total		122	135	257
Percent		47.5%	52.5%	
Peak		16:00	16:00	16:00
Vol.		24	29	53
P.H.F.		0.750	0.725	0.736
Grand Total		179	194	373
Percent		48.0%	52.0%	
ADT		Not Calculated		

Start Time	07-Dec-06 Thu	NB	SB	Total
12:00 AM		2	2	4
12:15		0	0	0
12:30		0	0	0
12:45		0	1	1
01:00		1	0	1
01:15		0	1	1
01:30		0	0	0
01:45		0	1	1
02:00		0	2	2
02:15		0	0	0
02:30		0	1	1
02:45		0	0	0
03:00		0	0	0
03:15		0	0	0
03:30		1	0	1
03:45		1	1	2
04:00		0	0	0
04:15		0	0	0
04:30		0	1	1
04:45		1	1	2
05:00		0	1	1
05:15		0	0	0
05:30		4	3	7
05:45		1	0	1
06:00		2	2	4
06:15		4	4	8
06:30		1	2	3
06:45		4	2	6
07:00		10	8	18
07:15		10	8	18
07:30		46	49	95
07:45		58	67	125
08:00		64	62	126
08:15		24	28	52
08:30		42	46	88
08:45		9	16	25
09:00		8	9	17
09:15		2	4	6
09:30		9	9	18
09:45		6	8	14
10:00		5	4	9
10:15		10	14	24
10:30		12	11	23
10:45		8	10	18
11:00		10	9	19
11:15		11	10	21
11:30		10	9	19
11:45		12	21	33
Total		388	427	815
Percent		47.6%	52.4%	
Peak		07:30	07:30	07:30
Vol.		192	206	398
P.H.F.		0.750	0.769	0.790

Start Time	07-Dec-06 Thu	NB	SB	Total
12:00 PM		11	14	25
12:15		8	10	18
12:30		3	1	4
12:45		9	10	19
01:00		14	18	32
01:15		9	12	21
01:30		14	14	28
01:45		15	16	31
02:00		20	20	40
02:15		27	51	78
02:30		16	16	32
02:45		10	11	21
03:00		12	14	26
03:15		12	19	31
03:30		26	30	56
03:45		13	23	36
04:00		12	13	25
04:15		6	9	15
04:30		8	14	22
04:45		7	8	15
05:00		8	16	24
05:15		6	12	18
05:30		5	14	19
05:45		11	17	28
06:00		4	7	11
06:15		10	17	27
06:30		7	9	16
06:45		8	14	22
07:00		5	4	9
07:15		6	5	11
07:30		5	6	11
07:45		7	6	13
08:00		8	6	14
08:15		4	7	11
08:30		6	10	16
08:45		4	7	11
09:00		5	10	15
09:15		4	6	10
09:30		6	6	12
09:45		6	9	15
10:00		1	1	2
10:15		1	0	1
10:30		2	5	7
10:45		1	1	2
11:00		0	2	2
11:15		1	3	4
11:30		3	2	5
11:45		0	1	1
Total		386	526	912
Percent		42.3%	57.7%	
Peak		13:45	13:45	13:45
Vol.		78	103	181
P.H.F.		0.722	0.505	0.580
Grand Total		774	953	1727
Percent		44.8%	55.2%	
ADT		Not Calculated		

Start Time	07-Dec-06 Thu	EB	WB	Total
12:00 AM		2	0	2
12:15		4	1	5
12:30		2	0	2
12:45		0	1	1
01:00		1	0	1
01:15		0	5	5
01:30		0	0	0
01:45		1	1	2
02:00		0	0	0
02:15		0	2	2
02:30		2	2	4
02:45		0	0	0
03:00		0	1	1
03:15		0	0	0
03:30		4	3	7
03:45		1	1	2
04:00		2	0	2
04:15		0	2	2
04:30		0	3	3
04:45		0	4	4
05:00		0	3	3
05:15		1	3	4
05:30		1	6	7
05:45		2	5	7
06:00		5	17	22
06:15		3	21	24
06:30		6	14	20
06:45		3	11	14
07:00		4	23	27
07:15		7	24	31
07:30		9	24	33
07:45		15	34	49
08:00		14	25	39
08:15		10	19	29
08:30		11	20	31
08:45		12	14	26
09:00		12	11	23
09:15		24	18	42
09:30		7	10	17
09:45		10	8	18
10:00		13	18	31
10:15		16	14	30
10:30		11	10	21
10:45		18	17	35
11:00		15	17	32
11:15		11	8	19
11:30		18	13	31
11:45		16	15	31
Total		293	448	741
Percent		39.5%	60.5%	
Peak		10:45	07:15	07:15
Vol.		62	107	152
P.H.F.		0.646	0.787	0.776

Start Time	07-Dec-06 Thu	EB	WB	Total
12:00 PM		17	14	31
12:15		13	13	26
12:30		20	12	32
12:45		24	30	54
01:00		17	10	27
01:15		26	16	42
01:30		21	16	37
01:45		10	14	24
02:00		30	23	53
02:15		22	26	48
02:30		22	24	46
02:45		20	12	32
03:00		32	19	51
03:15		20	24	44
03:30		35	16	51
03:45		44	23	67
04:00		27	22	49
04:15		38	18	56
04:30		32	25	57
04:45		27	20	47
05:00		37	19	56
05:15		55	24	79
05:30		38	29	67
05:45		27	22	49
06:00		37	15	52
06:15		22	21	43
06:30		26	20	46
06:45		27	24	51
07:00		14	14	28
07:15		21	11	32
07:30		18	11	29
07:45		18	10	28
08:00		16	12	28
08:15		18	6	24
08:30		14	12	26
08:45		16	10	26
09:00		21	12	33
09:15		16	9	25
09:30		13	6	19
09:45		8	1	9
10:00		10	5	15
10:15		4	2	6
10:30		6	8	14
10:45		7	2	9
11:00		3	1	4
11:15		0	4	4
11:30		2	0	2
11:45		2	1	3
Total		993	688	1681
Percent		59.1%	40.9%	
Peak		16:45	17:00	17:00
Vol.		157	94	251
P.H.F.		0.714	0.783	0.794
Grand Total		1286	1136	2422
Percent		53.1%	46.9%	
ADT		Not Calculated		

Start Time	07-Dec-06 Thu	NB	SB	Total
12:00 AM		2	0	2
12:15		1	3	4
12:30		1	0	1
12:45		2	2	4
01:00		2	0	2
01:15		0	1	1
01:30		0	0	0
01:45		0	0	0
02:00		1	1	2
02:15		0	0	0
02:30		2	1	3
02:45		0	0	0
03:00		0	0	0
03:15		0	0	0
03:30		2	2	4
03:45		0	2	2
04:00		2	0	2
04:15		1	0	1
04:30		2	2	4
04:45		1	1	2
05:00		1	3	4
05:15		2	2	4
05:30		5	1	6
05:45		3	2	5
06:00		6	0	6
06:15		10	6	16
06:30		8	5	13
06:45		6	1	7
07:00		16	5	21
07:15		24	16	40
07:30		15	14	29
07:45		16	16	32
08:00		12	8	20
08:15		14	21	35
08:30		23	24	47
08:45		8	10	18
09:00		12	12	24
09:15		10	20	30
09:30		10	4	14
09:45		10	6	16
10:00		12	7	19
10:15		14	10	24
10:30		10	5	15
10:45		12	12	24
11:00		5	8	13
11:15		12	6	18
11:30		6	7	13
11:45		4	9	13
Total		305	255	560
Percent		54.5%	45.5%	
Peak		07:00	07:45	07:45
Vol.		71	69	134
P.H.F.		0.740	0.719	0.713

Start Time	07-Dec-06 Thu	NB	SB	Total
12:00 PM		8	8	16
12:15		11	14	25
12:30		13	12	25
12:45		12	9	21
01:00		10	17	27
01:15		12	10	22
01:30		11	17	28
01:45		6	17	23
02:00		22	21	43
02:15		21	24	45
02:30		6	17	23
02:45		13	11	24
03:00		24	14	38
03:15		18	15	33
03:30		9	9	18
03:45		12	16	28
04:00		20	24	44
04:15		18	19	37
04:30		14	24	38
04:45		16	19	35
05:00		12	18	30
05:15		18	24	42
05:30		20	18	38
05:45		17	28	45
06:00		16	22	38
06:15		14	16	30
06:30		8	9	17
06:45		23	16	39
07:00		6	6	12
07:15		4	12	16
07:30		10	12	22
07:45		9	8	17
08:00		6	10	16
08:15		8	5	13
08:30		12	9	21
08:45		8	9	17
09:00		6	4	10
09:15		4	10	14
09:30		1	4	5
09:45		6	5	11
10:00		4	4	8
10:15		2	6	8
10:30		2	5	7
10:45		3	6	9
11:00		0	2	2
11:15		2	1	3
11:30		4	5	9
11:45		1	1	2
Total		502	592	1094
Percent		45.9%	54.1%	
Peak		17:15	17:15	17:15
Vol.		71	92	163
P.H.F.		0.740	0.821	0.906
Grand Total		807	847	1654
Percent		48.8%	51.2%	
ADT		Not Calculated		

Start Time	07-Dec-06 Thu	NB	SB	Total
12:00 AM		0	0	0
12:15		2	2	4
12:30		0	1	1
12:45		1	0	1
01:00		2	0	2
01:15		0	0	0
01:30		1	1	2
01:45		0	0	0
02:00		0	0	0
02:15		0	1	1
02:30		0	0	0
02:45		0	0	0
03:00		0	0	0
03:15		0	0	0
03:30		0	0	0
03:45		0	1	1
04:00		0	0	0
04:15		0	0	0
04:30		0	0	0
04:45		2	4	6
05:00		3	6	9
05:15		0	1	1
05:30		0	6	6
05:45		1	0	1
06:00		0	2	2
06:15		0	3	3
06:30		3	8	11
06:45		2	8	10
07:00		1	6	7
07:15		5	11	16
07:30		0	6	6
07:45		3	10	13
08:00		6	9	15
08:15		6	11	17
08:30		7	7	14
08:45		6	8	14
09:00		2	7	9
09:15		2	6	8
09:30		4	4	8
09:45		0	3	3
10:00		2	3	5
10:15		4	0	4
10:30		6	8	14
10:45		3	3	6
11:00		6	11	17
11:15		7	8	15
11:30		4	4	8
11:45		8	7	15
Total		99	176	275
Percent		36.0%	64.0%	
Peak		08:00	07:45	08:00
Vol.		25	37	60
P.H.F.		0.781	0.841	0.882





















Start Time	07-Dec-06 Thu	NB	SB	Total
12:00 PM		6	12	18
12:15		4	6	10
12:30		6	6	12
12:45		3	4	7
01:00		10	4	14
01:15		2	4	6
01:30		4	6	10
01:45		9	3	12
02:00		6	11	17
02:15		8	7	15
02:30		4	11	15
02:45		10	6	16
03:00		6	11	17
03:15		7	4	11
03:30		14	13	27
03:45		4	6	10
04:00		8	2	10
04:15		10	6	16
04:30		8	9	17
04:45		7	9	16
05:00		10	6	16
05:15		5	5	10
05:30		8	6	14
05:45		4	12	16
06:00		9	8	17
06:15		10	14	24
06:30		6	4	10
06:45		6	8	14
07:00		8	13	21
07:15		10	10	20
07:30		4	6	10
07:45		14	8	22
08:00		4	6	10
08:15		6	4	10
08:30		2	1	3
08:45		8	6	14
09:00		10	8	18
09:15		4	3	7
09:30		2	4	6
09:45		6	5	11
10:00		1	2	3
10:15		4	5	9
10:30		2	2	4
10:45		3	4	7
11:00		0	1	1
11:15		0	0	0
11:30		3	1	4
11:45		5	2	7
Total		290	294	584
Percent		49.7%	50.3%	
Peak		14:45	17:30	19:00
Vol.		37	40	73
P.H.F.		0.661	0.714	0.676
Grand Total		389	470	859
Percent		45.3%	54.7%	
ADT		Not Calculated		

Start Time	07-Dec-06 Thu	EB	WB	Total
12:00 AM		1	1	2
12:15		1	2	3
12:30		0	0	0
12:45		0	3	3
01:00		0	0	0
01:15		1	0	1
01:30		0	0	0
01:45		0	0	0
02:00		2	0	2
02:15		1	0	1
02:30		0	0	0
02:45		0	1	1
03:00		0	0	0
03:15		0	1	1
03:30		0	1	1
03:45		0	0	0
04:00		4	4	8
04:15		1	0	1
04:30		2	0	2
04:45		1	2	3
05:00		5	3	8
05:15		1	1	2
05:30		2	0	2
05:45		7	0	7
06:00		6	2	8
06:15		5	2	7
06:30		13	4	17
06:45		13	10	23
07:00		8	14	22
07:15		14	15	29
07:30		28	36	64
07:45		99	98	197
08:00		57	39	96
08:15		14	10	24
08:30		7	3	10
08:45		11	8	19
09:00		7	6	13
09:15		12	13	25
09:30		10	7	17
09:45		6	7	13
10:00		6	8	14
10:15		6	8	14
10:30		11	7	18
10:45		4	5	9
11:00		8	7	15
11:15		11	10	21
11:30		10	9	19
11:45		10	11	21
Total		405	358	763
Percent		53.1%	46.9%	
Peak		07:15	07:15	07:15
Vol.		198	188	386
P.H.F.		0.500	0.480	0.490





















Start Time	07-Dec-06 Thu	EB	WB	Total
12:00 PM		15	10	25
12:15		8	6	14
12:30		10	4	14
12:45		7	10	17
01:00		10	5	15
01:15		12	12	24
01:30		15	13	28
01:45		21	26	47
02:00		60	54	114
02:15		84	74	158
02:30		19	16	35
02:45		13	10	23
03:00		18	13	31
03:15		10	14	24
03:30		18	17	35
03:45		17	24	41
04:00		12	10	22
04:15		7	4	11
04:30		14	12	26
04:45		8	18	26
05:00		11	20	31
05:15		18	24	42
05:30		17	20	37
05:45		7	13	20
06:00		10	9	19
06:15		11	10	21
06:30		8	10	18
06:45		10	6	16
07:00		9	10	19
07:15		8	10	18
07:30		8	4	12
07:45		16	20	36
08:00		4	5	9
08:15		4	3	7
08:30		1	7	8
08:45		4	4	8
09:00		4	8	12
09:15		6	11	17
09:30		3	5	8
09:45		4	3	7
10:00		4	2	6
10:15		0	6	6
10:30		3	1	4
10:45		0	2	2
11:00		3	1	4
11:15		0	1	1
11:30		0	3	3
11:45		0	0	0
Total		551	570	1121
Percent		49.2%	50.8%	
Peak		13:45	13:45	13:45
Vol.		184	170	354
P.H.F.		0.548	0.574	0.560
Grand Total		956	928	1884
Percent		50.7%	49.3%	
ADT		Not Calculated		

Milwaukee TSP Update
1: Ochoco St & Hwy 99E

Existing Condition PM Peak Hour
HCM Signalized Intersection Capacity Analysis

												
Movement	EBL	EBT	EBR	WBL	WBT	WBR	NBL	NBT	NBR	SBL	SBT	SBR
Lane Configurations												
Ideal Flow (vphpl)	1800	1800	1800	1800	1800	1800	1800	1800	1800	1800	1800	1800
Total Lost time (s)		4.0	4.0		4.0	4.0		4.0	4.0		4.0	4.0
Lane Util. Factor		1.00	1.00		1.00	1.00		0.91	1.00		0.91	1.00
Frbp, ped/bikes		1.00	1.00		1.00	0.99		1.00	0.98		1.00	1.00
Flpb, ped/bikes		1.00	1.00		1.00	1.00		1.00	1.00		1.00	1.00
Frt		1.00	0.85		1.00	0.85		1.00	0.85		1.00	0.85
Flt Protected		0.96	1.00		0.98	1.00		1.00	1.00		1.00	1.00
Satd. Flow (prot)		1394	1378		1525	1227		4771	1123		4818	1205
Flt Permitted		0.76	1.00		0.88	1.00		1.00	1.00		1.00	1.00
Satd. Flow (perm)		1099	1378		1368	1227		4771	1123		4818	1205
Volume (vph)	89	30	47	11	19	48	0	1706	15	0	3167	110
Peak-hour factor, PHF	0.97	0.97	0.97	0.97	0.97	0.97	0.97	0.97	0.97	0.97	0.97	0.97
Adj. Flow (vph)	92	31	48	11	20	49	0	1759	15	0	3265	113
RTOR Reduction (vph)	0	0	4	0	0	43	0	0	3	0	0	21
Lane Group Flow (vph)	0	123	44	0	31	6	0	1759	12	0	3265	92
Confl. Peds. (#/hr)	1					1			1	1		
Heavy Vehicles (%)	10%	67%	11%	36%	5%	23%	0%	3%	33%	0%	2%	27%
Turn Type	Perm		Perm	Perm		Perm		Perm		Perm		Perm
Protected Phases		8			4			6			2	
Permitted Phases	8		8	4		4		6		6		2
Actuated Green, G (s)		13.0	13.0		13.0	13.0		96.5	96.5		96.5	96.5
Effective Green, g (s)		14.5	14.5		14.5	14.5		97.5	97.5		97.5	97.5
Actuated g/C Ratio		0.12	0.12		0.12	0.12		0.81	0.81		0.81	0.81
Clearance Time (s)		5.5	5.5		5.5	5.5		5.0	5.0		5.0	5.0
Vehicle Extension (s)		4.5	4.5		4.5	4.5		4.4	4.4		4.4	4.4
Lane Grp Cap (vph)		133	167		165	148		3876	912		3915	979
v/s Ratio Prot								0.37			c0.68	
v/s Ratio Perm		c0.11	0.03		0.02	0.00			0.01			0.08
v/c Ratio		0.92	0.27		0.19	0.04		0.45	0.01		0.83	0.09
Uniform Delay, d1		52.2	47.9		47.5	46.6		3.3	2.1		6.5	2.3
Progression Factor		1.00	1.00		1.00	1.00		0.89	0.01		1.00	1.00
Incremental Delay, d2		56.4	1.5		1.0	0.2		0.4	0.0		2.2	0.2
Delay (s)		108.6	49.4		48.4	46.8		3.3	0.1		8.8	2.5
Level of Service		F	D		D	D		A	A		A	A
Approach Delay (s)		92.0			47.4			3.3			8.6	
Approach LOS		F			D			A			A	
Intersection Summary												
HCM Average Control Delay			10.1								HCM Level of Service	B
HCM Volume to Capacity ratio			0.85									
Actuated Cycle Length (s)			120.0								Sum of lost time (s)	8.0
Intersection Capacity Utilization			85.2%								ICU Level of Service	E
Analysis Period (min)			15									
c Critical Lane Group												




















Movement	EBL	EBT	EBR	WBL	WBT	WBR	NBL	NBT	NBR	SBL	SBT	SBR
Lane Configurations		↕	↗		↕	↗		↑↑↑			↑↑↑	
Ideal Flow (vphpl)	1800	1800	1800	1800	1800	1800	1800	1800	1800	1800	1800	1800
Total Lost time (s)		4.0	4.0		4.0	4.0		4.0			4.0	
Lane Util. Factor		1.00	1.00		1.00	1.00		0.86			0.91	
Frbp, ped/bikes		1.00	0.99		1.00	1.00		1.00			1.00	
Flpb, ped/bikes		1.00	1.00		1.00	1.00		1.00			1.00	
Frt		1.00	0.85		1.00	0.85		1.00			1.00	
Flt Protected		0.98	1.00		0.97	1.00		1.00			1.00	
Satd. Flow (prot)		1614	1479		1746	1530		5954			4818	
Flt Permitted		0.86	1.00		0.80	1.00		1.00			1.00	
Satd. Flow (perm)		1409	1479		1444	1530		5954			4818	
Volume (vph)	27	37	62	22	15	16	0	1619	0	0	3144	0
Peak-hour factor, PHF	0.96	0.96	0.96	0.96	0.96	0.96	0.96	0.96	0.96	0.96	0.96	0.96
Adj. Flow (vph)	28	39	65	23	16	17	0	1686	0	0	3275	0
RTOR Reduction (vph)	0	0	4	0	0	16	0	0	0	0	0	0
Lane Group Flow (vph)	0	67	61	0	39	1	0	1686	0	0	3275	0
Confl. Peds. (#/hr)			1	1			1					1
Heavy Vehicles (%)	11%	8%	2%	0%	0%	0%	0%	4%	0%	0%	2%	75%
Turn Type	Perm		Perm	Perm		Perm						
Protected Phases		4			4			6			2	
Permitted Phases	4		4	4	4	4		6				
Actuated Green, G (s)		10.4	10.4		10.4	10.4		101.1			101.1	
Effective Green, g (s)		9.9	9.9		9.9	9.9		102.1			102.1	
Actuated g/C Ratio		0.08	0.08		0.08	0.08		0.85			0.85	
Clearance Time (s)		3.5	3.5		3.5	3.5		5.0			5.0	
Vehicle Extension (s)		2.5	2.5		2.5	2.5		4.5			4.5	
Lane Grp Cap (vph)		116	122		119	126		5066			4099	
v/s Ratio Prot								0.28			c0.68	
v/s Ratio Perm		c0.05	0.04		0.03	0.00						
v/c Ratio		0.58	0.50		0.33	0.01		0.33			0.80	
Uniform Delay, d1		53.0	52.7		51.9	50.6		1.9			4.2	
Progression Factor		1.00	1.00		1.00	1.00		1.98			0.19	
Incremental Delay, d2		5.6	2.4		1.2	0.0		0.2			0.9	
Delay (s)		58.6	55.1		53.1	50.6		3.8			1.7	
Level of Service		E	E		D	D		A			A	
Approach Delay (s)		56.9			52.3			3.8			1.7	
Approach LOS		E			D			A			A	
Intersection Summary												
HCM Average Control Delay			4.4					HCM Level of Service			A	
HCM Volume to Capacity ratio			0.78									
Actuated Cycle Length (s)			120.0					Sum of lost time (s)			8.0	
Intersection Capacity Utilization			84.4%					ICU Level of Service			E	
Analysis Period (min)			15									
c Critical Lane Group												

												
Movement	EBL	EBT	EBR	WBL	WBT	WBR	NBL	NBT	NBR	SBL	SBT	SBR
Lane Configurations												
Ideal Flow (vphpl)	1800	1800	1800	1800	1800	1800	1800	1800	1800	1800	1800	1800
Total Lost time (s)		4.0	4.0	4.0	4.0		4.0	4.0		4.0	4.0	
Lane Util. Factor		1.00	1.00	1.00	1.00		1.00	0.95		1.00	0.95	
Frbp, ped/bikes		1.00	1.00	1.00	1.00		1.00	1.00		1.00	1.00	
Flpb, ped/bikes		1.00	1.00	1.00	1.00		1.00	1.00		1.00	1.00	
Frt		1.00	0.85	1.00	0.95		1.00	0.98		1.00	1.00	
Flt Protected		0.99	1.00	0.95	1.00		0.95	1.00		0.95	1.00	
Satd. Flow (prot)		1751	1733	1660	1656		1840	3337		1800	3539	
Flt Permitted		0.99	1.00	0.95	1.00		0.95	1.00		0.95	1.00	
Satd. Flow (perm)		1751	1733	1660	1656		1840	3337		1800	3539	
Volume (vph)	17	91	481	179	59	32	232	789	147	133	1678	14
Peak-hour factor, PHF	0.96	0.96	0.96	0.96	0.96	0.96	0.96	0.96	0.96	0.96	0.96	0.96
Adj. Flow (vph)	18	95	501	186	61	33	242	822	153	139	1748	15
RTOR Reduction (vph)	0	0	16	0	16	0	0	10	0	0	0	0
Lane Group Flow (vph)	0	113	485	186	78	0	242	965	0	139	1763	0
Confl. Peds. (#/hr)			9	9			8		4	4		8
Confl. Bikes (#/hr)			1									
Heavy Vehicles (%)	2%	2%	2%	3%	3%	3%	4%	4%	4%	2%	2%	2%
Turn Type	Split		pt+ov	Split			Prot			Prot		
Protected Phases	8	8	8 1	4	4		1	6		5	2	
Permitted Phases												
Actuated Green, G (s)		11.0	34.0	11.5	11.5		19.0	67.9		13.1	62.0	
Effective Green, g (s)		11.0	34.0	11.5	11.5		19.0	68.4		13.1	62.5	
Actuated g/C Ratio		0.09	0.28	0.10	0.10		0.16	0.57		0.11	0.52	
Clearance Time (s)		4.0		4.0	4.0		4.0	4.5		4.0	4.5	
Vehicle Extension (s)		2.5		2.5	2.5		2.5	6.0		2.3	6.0	
Lane Grp Cap (vph)		161	491	159	159		291	1902		197	1843	
v/s Ratio Prot		0.06	c0.28	c0.11	0.05		0.13	0.29		0.08	c0.50	
v/s Ratio Perm												
v/c Ratio		0.70	0.99	1.17	0.49		0.83	0.51		0.71	0.96	
Uniform Delay, d1		52.9	42.8	54.2	51.5		48.9	15.6		51.6	27.4	
Progression Factor		1.00	1.00	1.00	1.00		0.93	1.07		0.89	0.97	
Incremental Delay, d2		12.1	37.2	124.3	1.7		16.4	0.9		6.8	9.8	
Delay (s)		65.0	80.0	178.6	53.2		62.1	17.6		52.6	36.3	
Level of Service		E	E	F	D		E	B		D	D	
Approach Delay (s)		77.2			136.5			26.4			37.5	
Approach LOS		E			F			C			D	
Intersection Summary												
HCM Average Control Delay			47.1				HCM Level of Service				D	
HCM Volume to Capacity ratio			0.99									
Actuated Cycle Length (s)			120.0				Sum of lost time (s)			12.0		
Intersection Capacity Utilization			102.3%				ICU Level of Service			G		
Analysis Period (min)			15									

c Critical Lane Group

Milwaukie TSP Update
4: Harrison St & 42nd Avenue

Existing Condition PM Peak Hour
HCM Unsignalized Intersection Capacity Analysis



















												
Movement	EBL	EBT	EBR	WBL	WBT	WBR	NBL	NBT	NBR	SBL	SBT	SBR
Lane Configurations												
Sign Control		Stop			Stop			Stop			Stop	
Volume (vph)	254	69	63	27	16	7	15	189	23	7	94	112
Peak Hour Factor	0.97	0.97	0.97	0.97	0.97	0.97	0.97	0.97	0.97	0.97	0.97	0.97
Hourly flow rate (vph)	262	71	65	28	16	7	15	195	24	7	97	115
Direction, Lane #	EB 1	EB 2	WB 1	WB 2	NB 1	SB 1	SB 2					
Volume Total (vph)	333	65	44	7	234	104	115					
Volume Left (vph)	262	0	28	0	15	7	0					
Volume Right (vph)	0	65	0	7	24	0	115					
Hadj (s)	0.43	-0.67	0.35	-0.67	-0.01	0.07	-0.67					
Departure Headway (s)	6.3	5.2	6.8	5.8	6.1	6.3	5.5					
Degree Utilization, x	0.59	0.09	0.08	0.01	0.40	0.18	0.18					
Capacity (veh/h)	549	656	479	556	551	535	603					
Control Delay (s)	16.7	7.6	9.3	7.7	13.1	9.5	8.5					
Approach Delay (s)	15.2		9.0		13.1	9.0						
Approach LOS	C		A		B	A						
Intersection Summary												
Delay			12.8									
HCM Level of Service			B									
Intersection Capacity Utilization			51.5%	ICU Level of Service		A						
Analysis Period (min)			15									















Movement	WBL	WBR	NBT	NBR	SBL	SBT
Lane Configurations	↙		↕↘		↙	↕↘
Ideal Flow (vphpl)	1800	1800	1800	1800	1800	1800
Total Lost time (s)	4.0		4.0		4.0	4.0
Lane Util. Factor	1.00		0.95		1.00	0.95
Frbp, ped/bikes	0.99		1.00		1.00	1.00
Flpb, ped/bikes	1.00		1.00		1.00	1.00
Frt	0.96		0.98		1.00	1.00
Flt Protected	0.96		1.00		0.95	1.00
Satd. Flow (prot)	1620		3221		1644	3353
Flt Permitted	0.96		1.00		0.95	1.00
Satd. Flow (perm)	1620		3221		1644	3353
Volume (vph)	202	74	1131	170	103	2138
Peak-hour factor, PHF	0.98	0.98	0.98	0.98	0.98	0.98
Adj. Flow (vph)	206	76	1154	173	105	2182
RTOR Reduction (vph)	12	0	9	0	0	0
Lane Group Flow (vph)	270	0	1318	0	105	2182
Confl. Peds. (#/hr)	3	3		2	2	
Heavy Vehicles (%)	2%	3%	4%	2%	4%	2%
Turn Type					Prot	
Protected Phases			2		1	6
Permitted Phases	8					
Actuated Green, G (s)	23.9		72.5		11.6	88.1
Effective Green, g (s)	23.9		72.5		11.6	88.1
Actuated g/C Ratio	0.20		0.60		0.10	0.73
Clearance Time (s)	4.0		4.0		4.0	4.0
Vehicle Extension (s)	3.0		3.0		3.0	3.0
Lane Grp Cap (vph)	323		1946		159	2462
v/s Ratio Prot			0.41		0.06	c0.65
v/s Ratio Perm	c0.17					
v/c Ratio	0.84		0.68		0.66	0.89
Uniform Delay, d1	46.2		15.9		52.3	12.1
Progression Factor	1.00		1.00		0.91	0.93
Incremental Delay, d2	16.8		1.9		5.5	2.9
Delay (s)	63.0		17.8		53.3	14.2
Level of Service	E		B		D	B
Approach Delay (s)	63.0		17.8			16.0
Approach LOS	E		B			B
Intersection Summary						
HCM Average Control Delay			20.0		HCM Level of Service	C
HCM Volume to Capacity ratio			0.88			
Actuated Cycle Length (s)			120.0		Sum of lost time (s)	8.0
Intersection Capacity Utilization			85.7%		ICU Level of Service	E
Analysis Period (min)			15			
c Critical Lane Group						

Milwaukie TSP Update
6: Harrison St & Main St





















Existing Condition PM Peak Hour
HCM Unsignalized Intersection Capacity Analysis

												
Movement	EBL	EBT	EBR	WBL	WBT	WBR	NBL	NBT	NBR	SBL	SBT	SBR
Lane Configurations												
Sign Control		Stop			Stop			Stop				Stop
Volume (vph)	45	221	88	28	192	81	21	53	56	105	70	66
Peak Hour Factor	0.98	0.98	0.98	0.98	0.98	0.98	0.98	0.98	0.98	0.98	0.98	0.98
Hourly flow rate (vph)	46	226	90	29	196	83	21	54	57	107	71	67
Direction, Lane #	EB 1	WB 1	NB 1	SB 1	SB 2							
Volume Total (vph)	361	307	133	107	139							
Volume Left (vph)	46	29	21	107	0							
Volume Right (vph)	90	83	57	0	67							
Hadj (s)	-0.08	-0.10	-0.02	0.62	-0.16							
Departure Headway (s)	5.5	5.6	6.4	7.3	6.5							
Degree Utilization, x	0.56	0.48	0.24	0.22	0.25							
Capacity (veh/h)	614	601	483	451	504							
Control Delay (s)	15.3	13.7	11.4	11.1	10.4							
Approach Delay (s)	15.3	13.7	11.4	10.7								
Approach LOS	C	B	B	B								
Intersection Summary												
Delay			13.2									
HCM Level of Service			B									
Intersection Capacity Utilization			57.0%	ICU Level of Service	B							
Analysis Period (min)			15									

						
Movement	WBL	WBR	NBT	NBR	SBL	SBT
Lane Configurations						
Ideal Flow (vphpl)	1800	1800	1800	1800	1800	1800
Total Lost time (s)	4.0	4.0	4.0	4.0	4.0	4.0
Lane Util. Factor	1.00	1.00	1.00	1.00	1.00	1.00
Frbp, ped/bikes	1.00	1.00	1.00	0.97	1.00	1.00
Flpb, ped/bikes	1.00	1.00	1.00	1.00	1.00	1.00
Frt	1.00	0.85	1.00	0.85	1.00	1.00
Flt Protected	0.95	1.00	1.00	1.00	0.95	1.00
Satd. Flow (prot)	1676	1515	1765	1488	1676	1765
Flt Permitted	0.95	1.00	1.00	1.00	0.95	1.00
Satd. Flow (perm)	1676	1515	1765	1488	1676	1765
Volume (vph)	67	325	249	66	506	541
Peak-hour factor, PHF	0.91	0.91	0.91	0.91	0.91	0.91
Adj. Flow (vph)	74	357	274	73	556	595
RTOR Reduction (vph)	0	109	0	44	0	0
Lane Group Flow (vph)	74	248	274	29	556	595
Confl. Peds. (#/hr)				2	2	
Confl. Bikes (#/hr)				1		
Heavy Vehicles (%)	2%	1%	2%	0%	2%	2%
Turn Type	pm+ov		Perm		Prot	
Protected Phases	8	1	2		1	6
Permitted Phases	8		2			
Actuated Green, G (s)	9.0	53.3	42.6	42.6	44.3	91.4
Effective Green, g (s)	9.5	54.3	42.6	42.6	44.8	91.4
Actuated g/C Ratio	0.09	0.50	0.39	0.39	0.41	0.84
Clearance Time (s)	4.5	4.5	4.0	4.0	4.5	4.0
Vehicle Extension (s)	3.0	4.5	2.3	2.3	4.5	2.3
Lane Grp Cap (vph)	146	811	690	582	689	1481
v/s Ratio Prot	c0.04	0.13	0.16		c0.33	c0.34
v/s Ratio Perm		0.04		0.02		
v/c Ratio	0.51	0.31	0.40	0.05	0.81	0.40
Uniform Delay, d1	47.5	16.2	23.9	20.6	28.2	2.1
Progression Factor	1.00	1.00	1.00	1.00	1.00	1.00
Incremental Delay, d2	2.8	0.4	1.7	0.2	7.6	0.8
Delay (s)	50.2	16.5	25.6	20.7	35.9	2.9
Level of Service	D	B	C	C	D	A
Approach Delay (s)	22.3		24.6		18.8	
Approach LOS	C		C		B	
Intersection Summary						
HCM Average Control Delay			20.7	HCM Level of Service		C
HCM Volume to Capacity ratio			0.59			
Actuated Cycle Length (s)			108.9	Sum of lost time (s)		8.0
Intersection Capacity Utilization			61.8%	ICU Level of Service		B
Analysis Period (min)			15			
c Critical Lane Group						

Milwaukie TSP Update
8: Harrison St & Hwy 224






















Existing Condition PM Peak Hour
HCM Signalized Intersection Capacity Analysis

												
Movement	EBL	EBT	EBR	WBL	WBT	WBR	NBL	NBT	NBR	SBL	SBT	SBR
Lane Configurations												
Ideal Flow (vphpl)	1800	1800	1800	1800	1800	1800	1800	1800	1800	1800	1800	1800
Total Lost time (s)		4.0			4.0		4.0	4.0	4.0	4.0	4.0	4.0
Lane Util. Factor		0.95			0.95		1.00	0.95	1.00	1.00	0.95	1.00
Frbp, ped/bikes		1.00			1.00		1.00	1.00	0.99	1.00	1.00	0.99
Flpb, ped/bikes		1.00			1.00		1.00	1.00	1.00	1.00	1.00	1.00
Frt		0.97			0.96		1.00	1.00	0.85	1.00	1.00	0.85
Flt Protected		1.00			0.99		0.95	1.00	1.00	0.95	1.00	1.00
Satd. Flow (prot)		2956			3135		1613	3288	1509	1676	3288	1336
Flt Permitted		0.94			0.71		0.95	1.00	1.00	0.95	1.00	1.00
Satd. Flow (perm)		2785			2253		1613	3288	1509	1676	3288	1336
Volume (vph)	8	265	79	69	282	117	64	851	68	263	1631	8
Peak-hour factor, PHF	0.95	0.95	0.95	0.95	0.95	0.95	0.95	0.95	0.95	0.95	0.95	0.95
Adj. Flow (vph)	8	279	83	73	297	123	67	896	72	277	1717	8
RTOR Reduction (vph)	0	22	0	0	27	0	0	0	35	0	0	2
Lane Group Flow (vph)	0	348	0	0	466	0	67	896	37	277	1717	6
Confl. Peds. (#/hr)	3		5	5		3	1		1	1		1
Confl. Bikes (#/hr)						1						
Heavy Vehicles (%)	0%	14%	3%	4%	4%	3%	6%	4%	0%	2%	4%	13%
Turn Type	Perm			Perm			Prot		Perm	Prot		Perm
Protected Phases		4			8		5	2		1		6
Permitted Phases	4			8					2			6
Actuated Green, G (s)		24.5			24.5		7.9	60.0	60.0	19.0	71.1	71.1
Effective Green, g (s)		26.0			26.0		8.9	62.0	62.0	20.0	73.1	73.1
Actuated g/C Ratio		0.22			0.22		0.07	0.52	0.52	0.17	0.61	0.61
Clearance Time (s)		5.5			5.5		5.0	6.0	6.0	5.0	6.0	6.0
Vehicle Extension (s)		2.5			2.5		2.3	4.0	4.0	2.3	4.0	4.0
Lane Grp Cap (vph)		603			488		120	1699	780	279	2003	814
v/s Ratio Prot							0.04	0.27		c0.17	c0.52	
v/s Ratio Perm		0.12			c0.21				0.02			0.00
v/c Ratio		0.58			0.95		0.56	0.53	0.05	0.99	0.86	0.01
Uniform Delay, d1		42.1			46.4		53.7	19.3	14.4	49.9	19.2	9.2
Progression Factor		1.00			1.00		0.80	1.89	3.73	1.13	0.79	0.69
Incremental Delay, d2		1.1			29.2		3.4	1.0	0.1	47.8	4.4	0.0
Delay (s)		43.2			75.6		46.4	37.4	53.7	104.2	19.5	6.4
Level of Service		D			E		D	D	D	F	B	A
Approach Delay (s)		43.2			75.6			39.1			31.2	
Approach LOS		D			E			D			C	
Intersection Summary												
HCM Average Control Delay			40.0				HCM Level of Service			D		
HCM Volume to Capacity ratio			0.89									
Actuated Cycle Length (s)			120.0				Sum of lost time (s)		8.0			
Intersection Capacity Utilization			93.4%				ICU Level of Service		F			
Analysis Period (min)			15									
c Critical Lane Group												







Movement	EBL	EBT	EBR	WBL	WBT	WBR	NBL	NBT	NBR	SBL	SBT	SBR
Lane Configurations		↕			↕		↗	↕	↗	↗	↗	↕
Ideal Flow (vphpl)	1800	1800	1800	1800	1800	1800	1800	1800	1800	1800	1800	1800
Total Lost time (s)		4.0			4.0		4.0	4.0	4.0	4.0	4.0	4.0
Lane Util. Factor		1.00			1.00		1.00	0.95	1.00	1.00	0.95	1.00
Frbp, ped/bikes		0.98			0.99		1.00	1.00	1.00	1.00	1.00	0.98
Flpb, ped/bikes		1.00			1.00		1.00	1.00	1.00	1.00	1.00	1.00
Frt		0.91			0.96		1.00	1.00	0.85	1.00	1.00	0.85
Flt Protected		0.99			0.99		0.95	1.00	1.00	0.95	1.00	1.00
Satd. Flow (prot)		1576			1665		1710	3320	1530	1541	3320	1431
Flt Permitted		0.97			0.85		0.07	1.00	1.00	0.95	1.00	1.00
Satd. Flow (perm)		1530			1432		122	3320	1530	1541	3320	1431
Volume (vph)	15	28	95	21	33	24	30	1254	3	9	1924	20
Peak-hour factor, PHF	0.94	0.94	0.94	0.94	0.94	0.94	0.94	0.94	0.94	0.94	0.94	0.94
Adj. Flow (vph)	16	30	101	22	35	26	32	1334	3	10	2047	21
RTOR Reduction (vph)	0	15	0	0	15	0	0	0	1	0	0	3
Lane Group Flow (vph)	0	132	0	0	68	0	32	1334	2	10	2047	18
Confl. Peds. (#/hr)	8		4	4		8	4					4
Confl. Bikes (#/hr)			1			2						
Heavy Vehicles (%)	0%	0%	2%	0%	0%	4%	0%	3%	0%	11%	3%	5%
Turn Type	Perm			Perm			Perm		Perm	Prot		Perm
Protected Phases		4			8			2		1		6
Permitted Phases	4			8			2		2			6
Actuated Green, G (s)		17.2			17.2		88.4	88.4	88.4	1.4	93.8	93.8
Effective Green, g (s)		17.2			17.2		89.4	89.4	89.4	1.4	94.8	94.8
Actuated g/C Ratio		0.14			0.14		0.74	0.74	0.74	0.01	0.79	0.79
Clearance Time (s)		4.0			4.0		5.0	5.0	5.0	4.0	5.0	5.0
Vehicle Extension (s)		3.0			2.5		5.2	5.2	5.2	2.5	5.2	5.2
Lane Grp Cap (vph)		219			205		91	2473	1140	18	2623	1130
v/s Ratio Prot								0.40		0.01	c0.62	
v/s Ratio Perm		c0.09			0.05		0.26		0.00			0.01
v/c Ratio		0.60			0.33		0.35	0.54	0.00	0.56	0.78	0.02
Uniform Delay, d1		48.2			46.2		5.3	6.5	3.9	59.0	6.9	2.7
Progression Factor		0.90			1.00		2.36	3.09	2.45	0.73	1.88	1.94
Incremental Delay, d2		4.6			0.7		8.9	0.7	0.0	17.5	1.5	0.0
Delay (s)		48.1			46.9		21.4	20.9	9.6	60.5	14.5	5.2
Level of Service		D			D		C	C	A	E	B	A
Approach Delay (s)		48.1			46.9			20.9			14.6	
Approach LOS		D			D			C			B	
Intersection Summary												
HCM Average Control Delay			19.0				HCM Level of Service				B	
HCM Volume to Capacity ratio			0.75									
Actuated Cycle Length (s)			120.0				Sum of lost time (s)				8.0	
Intersection Capacity Utilization			76.0%				ICU Level of Service				D	
Analysis Period (min)			15									
c Critical Lane Group												












Milwaukie TSP Update
10: Oak Street & Hwy 224

Existing Condition PM Peak Hour
HCM Signalized Intersection Capacity Analysis

													
Movement	NBL	NBT	NBR	SBL	SBT	SBR	SEL	SET	SER	NWL	NWT	NWR	
Lane Configurations													
Ideal Flow (vphpl)	1800	1800	1800	1800	1800	1800	1800	1800	1800	1800	1800	1800	
Total Lost time (s)		4.0	4.0		4.0		4.0	4.0	4.0	4.0	4.0	4.0	
Lane Util. Factor		0.95	1.00		0.95		1.00	0.95	1.00	1.00	0.95	1.00	
Frbp, ped/bikes		1.00	0.99		1.00		1.00	1.00	0.99	1.00	1.00	0.99	
Flpb, ped/bikes		1.00	1.00		1.00		1.00	1.00	1.00	1.00	1.00	1.00	
Frt		1.00	0.85		0.96		1.00	1.00	0.85	1.00	1.00	0.85	
Flt Protected		1.00	1.00		0.99		0.95	1.00	1.00	0.95	1.00	1.00	
Satd. Flow (prot)		3363	1495		3133		1710	3320	1510	1660	3257	1438	
Flt Permitted		0.84	1.00		0.73		0.95	1.00	1.00	0.95	1.00	1.00	
Satd. Flow (perm)		2838	1495		2329		1710	3320	1510	1660	3257	1438	
Volume (vph)	17	227	82	125	234	142	237	1629	38	103	938	117	
Peak-hour factor, PHF	0.94	0.94	0.94	0.94	0.94	0.94	0.94	0.94	0.94	0.94	0.94	0.94	
Adj. Flow (vph)	18	241	87	133	249	151	252	1733	40	110	998	124	
RTOR Reduction (vph)	0	0	11	0	34	0	0	0	16	0	0	58	
Lane Group Flow (vph)	0	259	76	0	499	0	252	1733	24	110	998	66	
Confl. Peds. (#/hr)	1		7	7		1	1		1	1		1	
Confl. Bikes (#/hr)						3							
Heavy Vehicles (%)	6%	1%	1%	6%	0%	4%	0%	3%	0%	3%	5%	5%	
Turn Type	Perm		pm+ov	Perm			Prot		Perm	Prot		Perm	
Protected Phases		4	5		8		1	6		5	2		
Permitted Phases	4		4	8				6				2	
Actuated Green, G (s)		25.5	40.0		25.5		17.5	65.5	65.5	14.5	62.5	62.5	
Effective Green, g (s)		26.0	41.0		26.0		18.0	67.0	67.0	15.0	64.0	64.0	
Actuated g/C Ratio		0.22	0.34		0.22		0.15	0.56	0.56	0.12	0.53	0.53	
Clearance Time (s)		4.5	4.5		4.5		4.5	5.5	5.5	4.5	5.5	5.5	
Vehicle Extension (s)		2.5	2.3		2.5		2.3	5.0	5.0	2.3	5.0	5.0	
Lane Grp Cap (vph)		615	561		505		257	1854	843	208	1737	767	
v/s Ratio Prot			0.02				0.15	c0.52		0.07	c0.31		
v/s Ratio Perm		0.09	0.03		c0.21				0.02			0.05	
v/c Ratio		0.42	0.14		0.99		0.98	0.93	0.03	0.53	0.57	0.09	
Uniform Delay, d1		40.5	27.3		46.8		50.8	24.5	11.9	49.2	18.8	13.7	
Progression Factor		1.00	1.00		1.00		0.93	0.89	0.62	1.38	1.87	5.53	
Incremental Delay, d2		0.3	0.1		36.4		38.7	6.9	0.0	1.4	1.3	0.2	
Delay (s)		40.9	27.3		83.2		86.0	28.7	7.4	69.2	36.4	76.0	
Level of Service		D	C		F		F	C	A	E	D	E	
Approach Delay (s)		37.5			83.2			35.4			43.3		
Approach LOS		D			F			D			D		
Intersection Summary													
HCM Average Control Delay			44.1				HCM Level of Service			D			
HCM Volume to Capacity ratio			0.88										
Actuated Cycle Length (s)			120.0				Sum of lost time (s)			8.0			
Intersection Capacity Utilization			93.6%				ICU Level of Service			F			
Analysis Period (min)			15										
c Critical Lane Group													

Movement	EBL	EBT	EBR	WBL	WBT	WBR	NBL	NBT	NBR	SBL	SBT	SBR
Lane Configurations												
Ideal Flow (vphpl)	1800	1800	1800	1800	1800	1800	1800	1800	1800	1800	1800	1800
Total Lost time (s)	4.0	4.0		4.0	4.0			4.0	4.0		4.0	4.0
Lane Util. Factor	1.00	1.00		1.00	1.00			1.00	1.00		1.00	1.00
Frbp, ped/bikes	1.00	1.00		1.00	1.00			1.00	0.97		1.00	0.99
Flpb, ped/bikes	1.00	1.00		1.00	1.00			1.00	1.00		1.00	1.00
Frt	1.00	1.00		1.00	0.99			1.00	0.85		1.00	0.85
Flt Protected	0.95	1.00		0.95	1.00			0.99	1.00		0.99	1.00
Satd. Flow (prot)	1578	1764		1706	1738			1702	1486		1697	1439
Flt Permitted	0.59	1.00		0.43	1.00			0.92	1.00		0.96	1.00
Satd. Flow (perm)	985	1764		764	1738			1575	1486		1633	1439
Volume (vph)	157	381	1	21	229	18	41	156	20	22	160	169
Peak-hour factor, PHF	0.94	0.94	0.94	0.94	0.94	0.94	0.94	0.94	0.94	0.94	0.94	0.94
Adj. Flow (vph)	167	405	1	22	244	19	44	166	21	23	170	180
RTOR Reduction (vph)	0	0	0	0	7	0	0	0	13	0	0	108
Lane Group Flow (vph)	167	406	0	22	256	0	0	210	8	0	193	72
Confl. Peds. (#/hr)	4		4	4		4	1		21	21		1
Confl. Bikes (#/hr)									2			
Heavy Vehicles (%)	8%	2%	0%	0%	2%	6%	7%	4%	0%	0%	6%	5%
Turn Type	Perm			Perm			Perm		Perm	Perm		Perm
Protected Phases		4			8			2				6
Permitted Phases	4			8			2		2	6		6
Actuated Green, G (s)	16.0	16.0		16.0	16.0			16.0	16.0		16.0	16.0
Effective Green, g (s)	16.0	16.0		16.0	16.0			16.0	16.0		16.0	16.0
Actuated g/C Ratio	0.40	0.40		0.40	0.40			0.40	0.40		0.40	0.40
Clearance Time (s)	4.0	4.0		4.0	4.0			4.0	4.0		4.0	4.0
Lane Grp Cap (vph)	394	706		306	695			630	594		653	576
v/s Ratio Prot		c0.23			0.15							
v/s Ratio Perm	0.17			0.03				c0.13	0.01		0.12	0.05
v/c Ratio	0.42	0.58		0.07	0.37			0.33	0.01		0.30	0.12
Uniform Delay, d1	8.7	9.4		7.4	8.4			8.3	7.2		8.2	7.6
Progression Factor	1.00	1.00		1.00	1.00			1.00	1.00		1.00	1.00
Incremental Delay, d2	3.3	3.4		0.5	1.5			1.4	0.0		1.2	0.4
Delay (s)	12.0	12.7		7.9	9.9			9.7	7.3		9.3	8.0
Level of Service	B	B		A	A			A	A		A	A
Approach Delay (s)		12.5			9.8			9.5			8.7	
Approach LOS		B			A			A			A	
Intersection Summary												
HCM Average Control Delay			10.5			HCM Level of Service			B			
HCM Volume to Capacity ratio			0.45									
Actuated Cycle Length (s)			40.0			Sum of lost time (s)			8.0			
Intersection Capacity Utilization			64.6%			ICU Level of Service			C			
Analysis Period (min)			15									
c Critical Lane Group												

						
Movement	NBL	NBT	SBT	SBR	NEL	NER
Lane Configurations		↑↑	↑↑			↗
Sign Control		Free	Free		Stop	
Grade		0%	0%		0%	
Volume (veh/h)	0	1219	1792	559	0	1
Peak Hour Factor	0.96	0.96	0.96	0.96	0.96	0.96
Hourly flow rate (vph)	0	1270	1867	582	0	1
Pedestrians					1	
Lane Width (ft)					12.0	
Walking Speed (ft/s)					4.0	
Percent Blockage					0	
Right turn flare (veh)						
Median type					None	
Median storage (veh)						
Upstream signal (ft)		507				
pX, platoon unblocked					1.00	
vC, conflicting volume	2450				2794	1225
vC1, stage 1 conf vol						
vC2, stage 2 conf vol						
vCu, unblocked vol	2450				2798	1225
tC, single (s)	4.1				6.8	7.0
tC, 2 stage (s)						
tF (s)	2.2				3.5	3.3
p0 queue free %	100				100	99
cM capacity (veh/h)	194				15	169
Direction, Lane #	NB 1	NB 2	SB 1	SB 2	NE 1	
Volume Total	635	635	1244	1205	1	
Volume Left	0	0	0	0	0	
Volume Right	0	0	0	582	1	
cSH	1700	1700	1700	1700	169	
Volume to Capacity	0.37	0.37	0.73	0.71	0.01	
Queue Length 95th (ft)	0	0	0	0	0	
Control Delay (s)	0.0	0.0	0.0	0.0	26.4	
Lane LOS					D	
Approach Delay (s)	0.0		0.0		26.4	
Approach LOS					D	
Intersection Summary						
Average Delay			0.0			
Intersection Capacity Utilization			81.2%		ICU Level of Service	D
Analysis Period (min)			15			

						
Movement	NBL	NBR	SET	SER	NWL	NWT
Lane Configurations						
Ideal Flow (vphpl)	1800	1800	1800	1800	1800	1800
Total Lost time (s)	4.0	4.0	4.0		4.0	4.0
Lane Util. Factor	1.00	1.00	0.95		1.00	0.95
Frt	1.00	0.85	1.00		1.00	1.00
Flt Protected	0.95	1.00	1.00		0.95	1.00
Satd. Flow (prot)	1660	1530	3353		1583	3353
Flt Permitted	0.95	1.00	1.00		0.95	1.00
Satd. Flow (perm)	1660	1530	3353		1583	3353
Volume (vph)	276	13	2066	0	13	1102
Peak-hour factor, PHF	0.91	0.91	0.91	0.91	0.91	0.91
Adj. Flow (vph)	303	14	2270	0	14	1211
RTOR Reduction (vph)	0	6	0	0	0	0
Lane Group Flow (vph)	303	8	2270	0	14	1211
Heavy Vehicles (%)	3%	0%	2%	0%	8%	2%
Turn Type		Prot			Prot	
Protected Phases	7	7	6		5	
Permitted Phases			6			2 7
Actuated Green, G (s)	27.4	27.4	100.1		2.9	139.4
Effective Green, g (s)	27.4	27.4	101.1		2.9	139.4
Actuated g/C Ratio	0.18	0.18	0.68		0.02	0.93
Clearance Time (s)	4.0	4.0	5.0		4.0	
Vehicle Extension (s)	2.3	2.3	8.0		2.3	
Lane Grp Cap (vph)	304	280	2266		31	3124
v/s Ratio Prot	c0.18	0.01	c0.68		0.01	
v/s Ratio Perm						c0.36
v/c Ratio	1.00	0.03	1.00		0.45	0.39
Uniform Delay, d1	61.1	50.2	24.2		72.6	0.5
Progression Factor	1.00	1.00	1.00		1.00	1.00
Incremental Delay, d2	50.4	0.0	19.3		6.0	0.0
Delay (s)	111.4	50.2	43.6		78.5	0.6
Level of Service	F	D	D		E	A
Approach Delay (s)	108.7		43.6			1.5
Approach LOS	F		D			A
Intersection Summary						
HCM Average Control Delay			35.5		HCM Level of Service	D
HCM Volume to Capacity ratio			0.99			
Actuated Cycle Length (s)			149.6		Sum of lost time (s)	18.2
Intersection Capacity Utilization			83.1%		ICU Level of Service	E
Analysis Period (min)			15			
c Critical Lane Group						

Milwaukie TSP Update
14: SE Lake Road & Oatfield Road

Existing Condition PM Peak Hour
HCM Signalized Intersection Capacity Analysis

Movement	EBL	EBT	EBR	WBL	WBT	WBR	NBL	NBT	NBR	SBL	SBT	SBR
Lane Configurations												
Ideal Flow (vphpl)	1800	1800	1800	1800	1800	1800	1800	1800	1800	1800	1800	1800
Total Lost time (s)	4.0	4.0		4.0	4.0		4.0	4.0		4.0	4.0	
Lane Util. Factor	1.00	1.00		1.00	1.00		1.00	1.00		1.00	1.00	
Frbp, ped/bikes	1.00	1.00		1.00	1.00		1.00	0.98		1.00	1.00	
Flpb, ped/bikes	1.00	1.00		1.00	1.00		1.00	1.00		1.00	1.00	
Frt	1.00	0.93		1.00	0.99		1.00	0.89		1.00	0.99	
Flt Protected	0.95	1.00		0.95	1.00		0.95	1.00		0.95	1.00	
Satd. Flow (prot)	1676	1648		1710	1780		1710	1580		1613	1744	
Flt Permitted	0.95	1.00		0.95	1.00		0.95	1.00		0.95	1.00	
Satd. Flow (perm)	1676	1648		1710	1780		1710	1580		1613	1744	
Volume (vph)	15	132	119	336	107	9	49	97	248	18	150	14
Peak-hour factor, PHF	0.97	0.97	0.97	0.97	0.97	0.97	0.97	0.97	0.97	0.97	0.97	0.97
Adj. Flow (vph)	15	136	123	346	110	9	51	100	256	19	155	14
RTOR Reduction (vph)	0	36	0	0	3	0	0	94	0	0	3	0
Lane Group Flow (vph)	15	223	0	346	116	0	51	262	0	19	166	0
Confl. Peds. (#/hr)							1		1	1		1
Heavy Vehicles (%)	2%	0%	3%	0%	0%	0%	0%	0%	0%	6%	0%	21%
Turn Type	Prot			Prot			Prot			Prot		
Protected Phases	7	4		3	8		5	2		1	6	
Permitted Phases												
Actuated Green, G (s)	0.7	17.5		19.3	36.1		3.7	27.5		1.4	25.2	
Effective Green, g (s)	0.7	17.5		19.3	36.1		3.7	27.5		1.4	25.2	
Actuated g/C Ratio	0.01	0.21		0.24	0.44		0.05	0.34		0.02	0.31	
Clearance Time (s)	4.0	4.0		4.0	4.0		4.0	4.0		4.0	4.0	
Vehicle Extension (s)	3.0	3.0		3.0	3.0		3.0	3.0		3.0	3.0	
Lane Grp Cap (vph)	14	353		404	787		77	532		28	538	
v/s Ratio Prot	0.01	c0.14		c0.20	0.06		c0.03	c0.17		0.01	0.09	
v/s Ratio Perm												
v/c Ratio	1.07	0.63		0.86	0.15		0.66	0.49		0.68	0.31	
Uniform Delay, d1	40.5	29.2		29.9	13.6		38.4	21.5		39.9	21.6	
Progression Factor	1.00	1.00		1.00	1.00		1.00	1.00		1.00	1.00	
Incremental Delay, d2	265.6	3.7		16.2	0.1		19.4	3.2		49.7	1.5	
Delay (s)	306.1	32.8		46.0	13.7		57.7	24.8		89.6	23.1	
Level of Service	F	C		D	B		E	C		F	C	
Approach Delay (s)		47.8			37.8			28.9			29.8	
Approach LOS		D			D			C			C	
Intersection Summary												
HCM Average Control Delay			36.0			HCM Level of Service				D		
HCM Volume to Capacity ratio			0.62									
Actuated Cycle Length (s)			81.7			Sum of lost time (s)			12.0			
Intersection Capacity Utilization			72.9%			ICU Level of Service				C		
Analysis Period (min)			15									
c Critical Lane Group												

Movement	EBL	EBT	EBR	WBL	WBT	WBR	NBL	NBT	NBR	SBL	SBT	SBR
Lane Configurations		↔			↔	↔	↔	↕	↔	↔	↕	↕
Ideal Flow (vphpl)	1800	1800	1800	1800	1800	1800	1800	1800	1800	1800	1800	1800
Total Lost time (s)		4.0			4.0	4.0	4.0	4.0	4.0	4.0	4.0	4.0
Lane Util. Factor		1.00			1.00	1.00	1.00	0.95	1.00	1.00	0.95	1.00
Frbp, ped/bikes		1.00			1.00	1.00	1.00	1.00	0.98	1.00	1.00	0.98
Flpb, ped/bikes		1.00			1.00	1.00	1.00	1.00	1.00	1.00	1.00	1.00
Frt		0.96			1.00	0.85	1.00	1.00	0.85	1.00	1.00	0.85
Flt Protected		0.99			0.97	1.00	0.95	1.00	1.00	0.95	1.00	1.00
Satd. Flow (prot)		1705			1697	1515	1710	3420	1466	1613	3420	1235
Flt Permitted		0.93			0.65	1.00	0.95	1.00	1.00	0.95	1.00	1.00
Satd. Flow (perm)		1599			1139	1515	1710	3420	1466	1613	3420	1235
Volume (vph)	19	54	36	121	61	120	40	956	77	80	1738	20
Peak-hour factor, PHF	0.94	0.94	0.94	0.94	0.94	0.94	0.94	0.94	0.94	0.94	0.94	0.94
Adj. Flow (vph)	20	57	38	129	65	128	43	1017	82	85	1849	21
RTOR Reduction (vph)	0	14	0	0	0	103	0	0	31	0	0	5
Lane Group Flow (vph)	0	101	0	0	194	25	43	1017	51	85	1849	16
Conf. Peds. (#/hr)							1		1	1		1
Heavy Vehicles (%)	0%	0%	0%	3%	2%	1%	0%	0%	2%	6%	0%	21%
Turn Type	Perm			Perm		Perm	Prot		Perm	Prot		Perm
Protected Phases		4			4		5	2		1		6
Permitted Phases	4			4		4			2			6
Actuated Green, G (s)		23.4			23.4	23.4	4.3	73.0	73.0	10.1	78.8	78.8
Effective Green, g (s)		23.4			23.4	23.4	4.3	74.5	74.5	10.1	80.3	80.3
Actuated g/C Ratio		0.19			0.19	0.19	0.04	0.62	0.62	0.08	0.67	0.67
Clearance Time (s)		4.0			4.0	4.0	4.0	5.5	5.5	4.0	5.5	5.5
Vehicle Extension (s)		2.5			2.5	2.5	0.5	4.6	4.6	2.5	2.6	2.6
Lane Grp Cap (vph)		312			222	295	61	2123	910	136	2289	826
v/s Ratio Prot							c0.03	0.30		0.05	c0.54	
v/s Ratio Perm		0.06			c0.17	0.02			0.03			0.01
v/c Ratio		0.32			0.87	0.08	0.70	0.48	0.06	0.62	0.81	0.02
Uniform Delay, d1		41.5			46.9	39.5	57.2	12.3	8.9	53.1	14.3	6.7
Progression Factor		1.00			1.00	1.00	0.89	1.60	2.72	1.12	1.24	0.59
Incremental Delay, d2		0.4			29.2	0.1	22.8	0.7	0.1	3.1	0.9	0.0
Delay (s)		41.9			76.0	39.6	73.6	20.3	24.4	62.9	18.6	3.9
Level of Service		D			E	D	E	C	C	E	B	A
Approach Delay (s)		41.9			61.6			22.6			20.3	
Approach LOS		D			E			C			C	
Intersection Summary												
HCM Average Control Delay			25.5									HCM Level of Service C
HCM Volume to Capacity ratio			0.82									
Actuated Cycle Length (s)			120.0									Sum of lost time (s) 12.0
Intersection Capacity Utilization			81.2%									ICU Level of Service D
Analysis Period (min)			15									
c Critical Lane Group												

Milwaukie TSP Update
16: Hwy 224 & Freeman Street

Existing Condition PM Peak Hour
HCM Signalized Intersection Capacity Analysis

Movement	EBL	EBT	EBR	WBL	WBT	WBR	NBL	NBT	NBR	SBL	SBT	SBR
Lane Configurations												
Ideal Flow (vphpl)	1800	1800	1800	1800	1800	1800	1800	1800	1800	1800	1800	1800
Total Lost time (s)	4.0	4.0	4.0	4.0	4.0	4.0		4.0			4.0	4.0
Lane Util. Factor	1.00	0.95	1.00	1.00	0.95	1.00		1.00			1.00	1.00
Frt	1.00	1.00	0.85	1.00	1.00	0.85		0.97			1.00	0.85
Flt Protected	0.95	1.00	1.00	0.95	1.00	1.00		0.98			0.96	1.00
Satd. Flow (prot)	1660	3196	1530	1660	3257	1404		1719			1696	1471
Flt Permitted	0.95	1.00	1.00	0.95	1.00	1.00		0.75			0.71	1.00
Satd. Flow (perm)	1660	3196	1530	1660	3257	1404		1317			1249	1471
Volume (vph)	40	1772	20	11	1029	108	24	29	14	224	34	68
Peak-hour factor, PHF	0.92	0.92	0.92	0.92	0.92	0.92	0.92	0.92	0.92	0.92	0.92	0.92
Adj. Flow (vph)	43	1926	22	12	1118	117	26	32	15	243	37	74
RTOR Reduction (vph)	0	0	5	0	0	47	0	8	0	0	0	56
Lane Group Flow (vph)	43	1926	17	12	1118	70	0	65	0	0	280	18
Heavy Vehicles (%)	3%	7%	0%	3%	5%	9%	0%	0%	0%	2%	0%	4%
Turn Type	Prot		Perm	Prot		Perm	Perm			Perm		Perm
Protected Phases	5	2		1	6			8			4	
Permitted Phases			2			6	8			4		4
Actuated Green, G (s)	7.4	74.5	74.5	2.8	69.9	69.9		29.2			29.2	29.2
Effective Green, g (s)	7.4	76.0	76.0	2.8	71.4	71.4		29.2			29.2	29.2
Actuated g/C Ratio	0.06	0.63	0.63	0.02	0.60	0.60		0.24			0.24	0.24
Clearance Time (s)	4.0	5.5	5.5	4.0	5.5	5.5		4.0			4.0	4.0
Vehicle Extension (s)	2.5	4.6	4.6	2.5	4.6	4.6		3.0			3.0	3.0
Lane Grp Cap (vph)	102	2024	969	39	1938	835		320			304	358
v/s Ratio Prot	0.03	c0.60		0.01	c0.34							
v/s Ratio Perm			0.01			0.05		0.05			c0.22	0.01
v/c Ratio	0.42	0.95	0.02	0.31	0.58	0.08		0.20			0.92	0.05
Uniform Delay, d1	54.2	20.3	8.2	57.6	15.0	10.4		36.1			44.3	34.8
Progression Factor	1.14	1.36	1.84	1.14	0.73	0.60		1.00			1.00	1.00
Incremental Delay, d2	1.2	7.2	0.0	3.0	1.2	0.2		0.3			31.8	0.1
Delay (s)	62.9	34.8	15.0	68.9	12.2	6.4		36.4			76.1	34.8
Level of Service	E	C	B	E	B	A		D			E	C
Approach Delay (s)		35.2			12.2			36.4			67.4	
Approach LOS		D			B			D			E	

Intersection Summary

HCM Average Control Delay	30.5	HCM Level of Service	C
HCM Volume to Capacity ratio	0.94		
Actuated Cycle Length (s)	120.0	Sum of lost time (s)	12.0
Intersection Capacity Utilization	80.0%	ICU Level of Service	D
Analysis Period (min)	15		

c Critical Lane Group



Movement	EBL	EBT	WBT	WBR	WBR2	SBL	SBR	SWL	SWR
Lane Configurations	↘	↑	↑			↘			
Ideal Flow (vphpl)	1800	1800	1800	1800	1800	1800	1800	1800	1800
Total Lost time (s)	4.0	4.0	4.0			4.0			
Lane Util. Factor	1.00	1.00	1.00			1.00			
Frt	1.00	1.00	0.97			0.99			
Flt Protected	0.95	1.00	1.00			0.95			
Satd. Flow (prot)	1555	1765	1701			1676			
Flt Permitted	0.95	1.00	1.00			0.95			
Satd. Flow (perm)	1555	1765	1701			1676			
Volume (vph)	102	363	439	0	120	188	8	0	0
Peak-hour factor, PHF	0.92	0.92	0.92	0.92	0.92	0.92	0.92	0.92	0.92
Adj. Flow (vph)	111	395	477	0	130	204	9	0	0
RTOR Reduction (vph)	0	0	11	0	0	2	0	0	0
Lane Group Flow (vph)	111	395	596	0	0	211	0	0	0
Heavy Vehicles (%)	10%	2%	3%	0%	2%	2%	0%	0%	0%
Turn Type	Prot								
Protected Phases	5	2	6			4			
Permitted Phases									
Actuated Green, G (s)	8.0	38.4	26.4			13.1			
Effective Green, g (s)	8.0	39.4	27.4			13.1			
Actuated g/C Ratio	0.13	0.65	0.45			0.22			
Clearance Time (s)	4.0	5.0	5.0			4.0			
Vehicle Extension (s)	3.0	3.0	3.0			3.0			
Lane Grp Cap (vph)	206	1149	770			363			
v/s Ratio Prot	c0.07	0.22	c0.35			c0.13			
v/s Ratio Perm									
v/c Ratio	0.54	0.34	0.77			0.58			
Uniform Delay, d1	24.5	4.7	13.9			21.2			
Progression Factor	1.00	1.00	1.00			1.00			
Incremental Delay, d2	2.7	0.2	4.9			2.4			
Delay (s)	27.2	4.9	18.8			23.6			
Level of Service	C	A	B			C			
Approach Delay (s)		9.8	18.8			23.6		0.0	
Approach LOS		A	B			C		A	

Intersection Summary

HCM Average Control Delay	16.1	HCM Level of Service	B
HCM Volume to Capacity ratio	0.68		
Actuated Cycle Length (s)	60.5	Sum of lost time (s)	12.0
Intersection Capacity Utilization	59.6%	ICU Level of Service	B
Analysis Period (min)	15		

c Critical Lane Group

Milwaukie TSP Update
18: Harrison St & 21st Street

Existing Condition PM Peak Hour
HCM Unsignalized Intersection Capacity Analysis



Movement	EBL	EBT	EBR	WBL	WBT	WBR	NBL	NBT	NBR	SBL	SBT	SBR
Lane Configurations		↕			↕			↕			↕	
Sign Control		Free			Free			Stop			Stop	
Grade		0%			0%			0%			0%	
Volume (veh/h)	10	360	45	42	228	18	13	13	69	15	8	6
Peak Hour Factor	0.97	0.97	0.97	0.97	0.97	0.97	0.97	0.97	0.97	0.97	0.97	0.97
Hourly flow rate (vph)	10	371	46	43	235	19	13	13	71	15	8	6
Pedestrians												
Lane Width (ft)												
Walking Speed (ft/s)												
Percent Blockage												
Right turn flare (veh)												
Median type								None			None	
Median storage (veh)												
Upstream signal (ft)												
pX, platoon unblocked												
vC, conflicting volume	254			418			756	755	394	824	769	244
vC1, stage 1 conf vol												
vC2, stage 2 conf vol												
vCu, unblocked vol	254			418			756	755	394	824	769	244
tC, single (s)	4.1			4.1			7.1	6.5	6.2	7.1	6.5	6.2
tC, 2 stage (s)												
tF (s)	2.2			2.2			3.5	4.0	3.3	3.5	4.0	3.3
p0 queue free %	99			96			96	96	89	94	97	99
cM capacity (veh/h)	1312			1142			305	322	655	243	316	794
Direction, Lane #	EB 1	WB 1	NB 1	SB 1								
Volume Total	428	297	98	30								
Volume Left	10	43	13	15								
Volume Right	46	19	71	6								
cSH	1312	1142	504	307								
Volume to Capacity	0.01	0.04	0.19	0.10								
Queue Length 95th (ft)	1	3	18	8								
Control Delay (s)	0.3	1.5	13.9	18.0								
Lane LOS	A	A	B	C								
Approach Delay (s)	0.3	1.5	13.9	18.0								
Approach LOS			B	C								
Intersection Summary												
Average Delay			2.9									
Intersection Capacity Utilization			49.8%		ICU Level of Service				A			
Analysis Period (min)			15									



Movement	WBL	WBR	NBL	NBR	SEL	SER
Lane Configurations	T		T		T	
Sign Control	Stop		Stop		Stop	
Volume (vph)	60	362	132	44	544	245
Peak Hour Factor	0.97	0.97	0.97	0.97	0.97	0.97
Hourly flow rate (vph)	62	373	136	45	561	253
Direction, Lane #	WB 1	NB 1	SE 1			
Volume Total (vph)	435	181	813			
Volume Left (vph)	62	0	561			
Volume Right (vph)	373	45	0			
Hadj (s)	-0.45	-0.12	0.17			
Departure Headway (s)	5.7	6.2	5.8			
Degree Utilization, x	0.69	0.31	1.31			
Capacity (veh/h)	616	559	620			
Control Delay (s)	20.3	11.9	167.7			
Approach Delay (s)	20.3	11.9	167.7			
Approach LOS	C	B	F			
Intersection Summary						
Delay			103.1			
HCM Level of Service			F			
Intersection Capacity Utilization			95.3%	ICU Level of Service	F	
Analysis Period (min)			15			

Milwaukie TSP Update
20: Johnson Creek Blvd & SE Linwood Avenue

Existing Condition PM Peak Hour
HCM Signalized Intersection Capacity Analysis

Movement	EBL	EBT	EBR	WBL	WBT	WBR	NBL	NBT	NBR	SBL	SBT	SBR
Lane Configurations												
Ideal Flow (vphpl)	1800	1800	1800	1800	1800	1800	1800	1800	1800	1800	1800	1800
Total Lost time (s)	4.0	4.0		4.0	4.0		4.0	4.0		4.0	4.0	
Lane Util. Factor	1.00	1.00		1.00	1.00		1.00	1.00		1.00	1.00	
Frbp, ped/bikes	1.00	0.99		1.00	1.00		1.00	0.99		1.00	1.00	
Flpb, ped/bikes	1.00	1.00		1.00	1.00		1.00	1.00		1.00	1.00	
Frt	1.00	0.98		1.00	0.97		1.00	0.94		1.00	0.99	
Flt Protected	0.95	1.00		0.95	1.00		0.95	1.00		0.95	1.00	
Satd. Flow (prot)	1629	1664		1660	1682		1676	1664		1613	1752	
Flt Permitted	0.22	1.00		0.08	1.00		0.95	1.00		0.95	1.00	
Satd. Flow (perm)	377	1664		134	1682		1676	1664		1613	1752	
Volume (vph)	19	626	125	160	551	122	104	215	128	90	174	11
Peak-hour factor, PHF	0.91	0.91	0.91	0.91	0.91	0.91	0.91	0.91	0.91	0.91	0.91	0.91
Adj. Flow (vph)	21	688	137	176	605	134	114	236	141	99	191	12
RTOR Reduction (vph)	0	10	0	0	7	0	0	19	0	0	2	0
Lane Group Flow (vph)	21	815	0	176	732	0	114	358	0	99	201	0
Confl. Peds. (#/hr)	1		7	7		1	11		2	2		11
Confl. Bikes (#/hr)			2						1			
Heavy Vehicles (%)	5%	5%	3%	3%	4%	2%	2%	1%	1%	6%	1%	9%
Turn Type	pm+pt			pm+pt			Prot			Prot		
Protected Phases	7	4		3	8		5	2		1	6	
Permitted Phases	4			8								
Actuated Green, G (s)	58.0	56.4		68.4	62.8		9.7	25.0		7.0	22.3	
Effective Green, g (s)	58.0	56.4		68.4	62.8		9.7	25.0		7.0	22.3	
Actuated g/C Ratio	0.52	0.50		0.61	0.56		0.09	0.22		0.06	0.20	
Clearance Time (s)	4.0	4.0		4.0	4.0		4.0	4.0		4.0	4.0	
Vehicle Extension (s)	3.0	3.0		3.0	3.0		3.0	3.0		3.0	3.0	
Lane Grp Cap (vph)	212	835		190	940		145	370		100	348	
v/s Ratio Prot	0.00	c0.49		c0.07	0.44		0.07	c0.21		c0.06	0.11	
v/s Ratio Perm	0.05			0.50								
v/c Ratio	0.10	0.98		0.93	0.78		0.79	0.97		0.99	0.58	
Uniform Delay, d1	16.0	27.3		29.7	19.4		50.3	43.3		52.7	40.8	
Progression Factor	1.00	1.00		1.00	1.00		1.00	1.00		1.00	1.00	
Incremental Delay, d2	0.2	25.1		44.4	4.1		23.9	39.0		86.6	6.8	
Delay (s)	16.2	52.5		74.1	23.5		74.2	82.3		139.3	47.6	
Level of Service	B	D		E	C		E	F		F	D	
Approach Delay (s)		51.6			33.2			80.4			77.6	
Approach LOS		D			C			F			E	
Intersection Summary												
HCM Average Control Delay			53.6			HCM Level of Service				D		
HCM Volume to Capacity ratio			0.97									
Actuated Cycle Length (s)			112.4			Sum of lost time (s)			16.0			
Intersection Capacity Utilization			91.1%			ICU Level of Service			F			
Analysis Period (min)			15									
c Critical Lane Group												

HCM Signalized Intersection Capacity Analysis
 1112: SE Linwood Avenue & King Road

6/29/2012



Movement	EBL	EBT	EBR	WBL	WBT	WBR	NBL	NBT	NBR	SBL	SBT	SBR
Lane Configurations	↖	↗		↖	↗		↖	↗		↖	↗	
Volume (vph)	110	515	90	90	365	45	100	205	75	40	235	90
Ideal Flow (vphpl)	1900	1900	1900	1900	1900	1900	1900	1900	1900	1900	1900	1900
Total Lost time (s)	4.0	4.0		4.0	4.0		4.0	4.0		4.0	4.0	
Lane Util. Factor	1.00	1.00		1.00	1.00		1.00	1.00		1.00	1.00	
Frbp, ped/bikes	1.00	0.99		1.00	0.99		1.00	0.99		1.00	0.99	
Flpb, ped/bikes	1.00	1.00		1.00	1.00		1.00	1.00		1.00	1.00	
Frt	1.00	0.98		1.00	0.98		1.00	0.96		1.00	0.96	
Flt Protected	0.95	1.00		0.95	1.00		0.95	1.00		0.95	1.00	
Satd. Flow (prot)	1770	1808		1787	1839		1770	1777		1805	1760	
Flt Permitted	0.95	1.00		0.95	1.00		0.95	1.00		0.95	1.00	
Satd. Flow (perm)	1770	1808		1787	1839		1770	1777		1805	1760	
Peak-hour factor, PHF	0.95	0.95	0.95	0.95	0.95	0.95	0.95	0.95	0.95	0.95	0.95	0.95
Adj. Flow (vph)	116	542	95	95	384	47	105	216	79	42	247	95
RTOR Reduction (vph)	0	7	0	0	5	0	0	13	0	0	15	0
Lane Group Flow (vph)	116	630	0	95	426	0	105	282	0	42	327	0
Confl. Peds. (#/hr)	17		7	7			17	5		5	5	
Confl. Bikes (#/hr)							1					2
Heavy Vehicles (%)	2%	2%	3%	1%	1%	0%	2%	2%	1%	0%	3%	1%
Turn Type	Prot	NA		Prot	NA		Prot	NA		Prot	NA	
Protected Phases	7	4		3	8		5	2		1	6	
Permitted Phases												
Actuated Green, G (s)	8.5	31.2		8.3	31.0		6.0	29.0		2.9	25.9	
Effective Green, g (s)	8.5	31.2		8.3	31.0		6.0	29.0		2.9	25.9	
Actuated g/C Ratio	0.10	0.36		0.09	0.35		0.07	0.33		0.03	0.30	
Clearance Time (s)	4.0	4.0		4.0	4.0		4.0	4.0		4.0	4.0	
Vehicle Extension (s)	3.0	3.0		3.0	3.0		3.0	3.0		3.0	3.0	
Lane Grp Cap (vph)	172	645		170	652		122	590		60	522	
v/s Ratio Prot	c0.07	c0.35		0.05	0.23		c0.06	c0.16		0.02	c0.19	
v/s Ratio Perm												
v/c Ratio	0.67	0.98		0.56	0.65		0.86	0.48		0.70	0.63	
Uniform Delay, d1	38.1	27.7		37.8	23.7		40.3	23.2		41.8	26.6	
Progression Factor	1.00	1.00		1.00	1.00		1.00	1.00		1.00	1.00	
Incremental Delay, d2	10.0	29.3		3.9	2.4		42.2	2.8		30.0	5.6	
Delay (s)	48.1	57.1		41.7	26.0		82.5	25.9		71.8	32.2	
Level of Service	D	E		D	C		F	C		E	C	
Approach Delay (s)		55.7			28.9			40.8			36.5	
Approach LOS		E			C			D			D	





















Intersection Summary

HCM Average Control Delay	42.4	HCM Level of Service	D
HCM Volume to Capacity ratio	0.79		
Actuated Cycle Length (s)	87.4	Sum of lost time (s)	16.0
Intersection Capacity Utilization	74.5%	ICU Level of Service	D
Analysis Period (min)	15		

c Critical Lane Group

Milwaukee TSP Update
22: Harmony & SE Linwood Avenue

Existing Condition PM Peak Hour
HCM Signalized Intersection Capacity Analysis

												
Movement	EBL	EBT	EBR	WBL	WBT	WBR	NBL	NBT	NBR	SBL	SBT	SBR
Lane Configurations												
Ideal Flow (vphpl)	1800	1800	1800	1800	1800	1800	1800	1800	1800	1800	1800	1800
Total Lost time (s)	4.0	4.0		4.0	4.0			4.0	4.0	4.0	4.0	
Lane Util. Factor	1.00	1.00		1.00	1.00			1.00	1.00	1.00	1.00	
Frbp, ped/bikes	1.00	1.00		1.00	1.00			1.00	0.99	1.00	1.00	
Flpb, ped/bikes	1.00	1.00		1.00	1.00			1.00	1.00	1.00	1.00	
Frt	1.00	0.97		1.00	0.96			1.00	0.85	1.00	0.99	
Flt Protected	0.95	1.00		0.95	1.00			0.99	1.00	0.95	1.00	
Satd. Flow (prot)	1710	1727		1676	1700			1750	1485	1676	1741	
Flt Permitted	0.95	1.00		0.95	1.00			0.99	1.00	0.95	1.00	
Satd. Flow (perm)	1710	1727		1676	1700			1750	1485	1676	1741	
Volume (vph)	42	268	69	328	307	99	50	245	571	99	322	23
Peak-hour factor, PHF	0.90	0.90	0.90	0.90	0.90	0.90	0.90	0.90	0.90	0.90	0.90	0.90
Adj. Flow (vph)	47	298	77	364	341	110	56	272	634	110	358	26
RTOR Reduction (vph)	0	6	0	0	8	0	0	0	227	0	2	0
Lane Group Flow (vph)	47	369	0	364	443	0	0	328	407	110	382	0
Conf. Peds. (#/hr)	5			1								7
Conf. Bikes (#/hr)									1			1
Heavy Vehicles (%)	0%	1%	1%	2%	2%	2%	2%	2%	2%	2%	2%	2%
Turn Type	Prot		Prot				Split		pm+ov		Split	
Protected Phases	5	2		1	6		8	8	1	4	4	
Permitted Phases									8			
Actuated Green, G (s)	6.2	34.1		32.4	60.3			28.1	60.5	32.5	32.5	
Effective Green, g (s)	7.2	35.1		33.4	61.3			29.1	62.5	33.5	33.5	
Actuated g/C Ratio	0.05	0.24		0.23	0.42			0.20	0.42	0.23	0.23	
Clearance Time (s)	5.0	5.0		5.0	5.0			5.0	5.0	5.0	5.0	
Vehicle Extension (s)	3.0	3.0		3.0	3.0			3.0	3.0	3.0	3.0	
Lane Grp Cap (vph)	84	412		381	708			346	671	382	396	
v/s Ratio Prot	0.03	c0.21		c0.22	0.26			c0.19	0.14	0.07	c0.22	
v/s Ratio Perm									0.14			
v/c Ratio	0.56	0.90		0.96	0.63			0.95	0.61	0.29	0.97	
Uniform Delay, d1	68.4	54.2		56.1	33.9			58.3	32.8	46.9	56.2	
Progression Factor	1.00	1.00		1.00	1.00			1.00	1.00	1.00	1.00	
Incremental Delay, d2	7.9	21.2		34.3	1.7			34.6	1.6	0.4	36.0	
Delay (s)	76.3	75.5		90.5	35.6			92.8	34.3	47.4	92.2	
Level of Service	E	E		F	D			F	C	D	F	
Approach Delay (s)		75.5			60.1			54.3			82.2	
Approach LOS		E			E			D			F	
Intersection Summary												
HCM Average Control Delay			64.5			HCM Level of Service				E		
HCM Volume to Capacity ratio			0.94									
Actuated Cycle Length (s)			147.1			Sum of lost time (s)				16.0		
Intersection Capacity Utilization			87.8%			ICU Level of Service				E		
Analysis Period (min)			15									
c Critical Lane Group												

HCM Unsignalized Intersection Capacity Analysis
 1111: 42nd Avenue & SE King Road

6/29/2012



Movement	EBL	EBR	NBL	NBT	SBT	SBR
Lane Configurations						
Volume (veh/h)	95	30	35	485	225	115
Sign Control	Stop			Free	Free	
Grade	0%			0%	0%	
Peak Hour Factor	0.92	0.92	0.92	0.92	0.92	0.92
Hourly flow rate (vph)	103	33	38	527	245	125
Pedestrians	12			3		
Lane Width (ft)	12.0			12.0		
Walking Speed (ft/s)	4.0			4.0		
Percent Blockage	1			0		
Right turn flare (veh)						
Median type				TWLTL	TWLTL	
Median storage veh				2	2	
Upstream signal (ft)						
pX, platoon unblocked						
vC, conflicting volume	925	319	382			
vC1, stage 1 conf vol	319					
vC2, stage 2 conf vol	606					
vCu, unblocked vol	925	319	382			
tC, single (s)	6.4	6.2	4.1			
tC, 2 stage (s)	5.4					
tF (s)	3.5	3.3	2.2			
p0 queue free %	78	95	97			
cM capacity (veh/h)	479	719	1160			

Direction, Lane #	EB 1	NB 1	NB 2	SB 1
Volume Total	136	38	527	370
Volume Left	103	38	0	0
Volume Right	33	0	0	125
cSH	521	1160	1700	1700
Volume to Capacity	0.26	0.03	0.31	0.22
Queue Length 95th (ft)	26	3	0	0
Control Delay (s)	14.3	8.2	0.0	0.0
Lane LOS	B	A		
Approach Delay (s)	14.3	0.6		0.0
Approach LOS	B			

Intersection Summary			
Average Delay		2.1	
Intersection Capacity Utilization		39.7%	ICU Level of Service A
Analysis Period (min)		15	

HCM Unsignalized Intersection Capacity Analysis
 1113: SE Linwood Avenue & SE Monroe Street

6/29/2012



Movement	EBL	EBT	EBR	WBL	WBT	WBR	NBL	NBT	NBR	SBL	SBT	SBR
Lane Configurations		↔			↔			↔			↔	
Volume (veh/h)	35	60	35	15	45	55	35	290	20	40	315	60
Sign Control		Stop			Stop			Free			Free	
Grade		0%			0%			0%			0%	
Peak Hour Factor	0.92	0.92	0.92	0.92	0.92	0.92	0.92	0.92	0.92	0.92	0.92	0.92
Hourly flow rate (vph)	38	65	38	16	49	60	38	315	22	43	342	65
Pedestrians		1			5						2	
Lane Width (ft)		12.0			12.0						12.0	
Walking Speed (ft/s)		4.0			4.0						4.0	
Percent Blockage		0			0						0	
Right turn flare (veh)												
Median type								None			None	
Median storage (veh)												
Upstream signal (ft)											1218	
pX, platoon unblocked												
vC, conflicting volume	951	881	376	940	903	333	409			342		
vC1, stage 1 conf vol												
vC2, stage 2 conf vol												
vCu, unblocked vol	951	881	376	940	903	333	409			342		
tC, single (s)	7.1	6.5	6.2	7.1	6.5	6.2	4.1			4.1		
tC, 2 stage (s)												
tF (s)	3.5	4.0	3.3	3.5	4.0	3.3	2.2			2.2		
p0 queue free %	79	76	94	91	81	92	97			96		
cM capacity (veh/h)	178	267	674	178	259	709	1144			1223		

Direction, Lane #	EB 1	WB 1	NB 1	SB 1
Volume Total	141	125	375	451
Volume Left	38	16	38	43
Volume Right	38	60	22	65
cSH	275	343	1144	1223
Volume to Capacity	0.51	0.36	0.03	0.04
Queue Length 95th (ft)	68	41	3	3
Control Delay (s)	31.2	21.4	1.1	1.1
Lane LOS	D	C	A	A
Approach Delay (s)	31.2	21.4	1.1	1.1
Approach LOS	D	C		

Intersection Summary			
Average Delay		7.3	
Intersection Capacity Utilization	49.0%		ICU Level of Service A
Analysis Period (min)		15	

Milwaukee TSP Update

Future Volume Forecasts

Scenario: 2035 PM "Low Build" (Financially Committed)

Date: 6/29/2012






















N/S	E/W	#	NBL	NBT	NBR	SBL	SBT	SBR	EBL	EBT	EBR	WBL	WBT	WBR
McLoughlin Blvd	Ochoco St	1	0	2000	20	0	3290	220	120	40	200	10	270	160
McLoughlin Blvd	Milport Road	2	280	2020	100	0	3540	20	20	20	270	250	30	20
McLoughlin Blvd	Harrison St	3	20	1120	170	100	2290	20	20	20	20	190	20	10
42nd Avenue	Harrison St	4	20	20	20	10	20	50	240	10	20	10	20	10
McLoughlin Blvd	Washington St	5	10	1050	30	100	2200	10	0	10	10	20	10	140
Main Street	Harrison St	6	20	20	20	20	20	80	70	10	10	20	110	60
17th Avenue	Hwy 224	7	0	20	100	370	20	0	0	0	0	110	0	20
Hwy 224	Harrison St	8	60	1190	250	20	2250	180	90	200	20	310	210	20
Hwy 224	Monroe Street	9	60	1920	10	20	2770	10	20	20	160	20	30	20
Hwy 224	Oak Street	10	200	1470	20	260	2290	260	140	140	110	20	110	180
32nd Avenue	Harrison St	11	40	20	20	20	40	400	420	530	10	20	430	10
McLoughlin Blvd	22nd Ave	12	110	990	0	0	1400	780	0	0	10	0	0	0
McLoughlin Blvd	River Road	13	10	950	0	0	1680	0	310	0	130	0	0	0
Oatfield Rd	Lake Road	14	70	190	180	140	320	10	20	20	90	180	30	70
Hwy 224	37th Ave	15	70	1240	20	220	1870	50	50	90	440	290	270	380
Freeman Way	Hwy 224	16	20	30	10	510	30	140	30	2420	30	10	1450	240
Hwy 224 off/on ramp	Lake Road	17	170	0	160	110	820	10	100	240	100	0	70	120
21st Ave	Harrison St	18	20	10	30	20	10	10	10	140	20	20	150	20
32nd Avenue	Johnson Creek Blvd	19	20	130	30	540	250	0	0	70	90	40	20	360
Linwood Ave	Johnson Creek Blvd	20	140	220	50	180	310	120	140	860	230	10	820	230
Linwood Ave	King Road	21	50	420	150	20	520	20	20	100	50	230	20	20
Linwood Ave	Harmony Rd	22	50	450	1660	270	570	20	40	270	70	1460	310	280









































Movement	EBL	EBT	EBR	WBL	WBT	WBR	NBL	NBT	NBR	SBL	SBT	SBR	
Lane Configurations		↕	↗		↕	↗		↑↑↑	↗		↑↑↑	↗	
Ideal Flow (vphpl)	1800	1800	1800	1800	1800	1800	1800	1800	1800	1800	1800	1800	
Total Lost time (s)		4.0	4.0		4.0	4.0		4.0	4.0		4.0	4.0	
Lane Util. Factor		1.00	1.00		1.00	1.00		0.91	1.00		0.91	1.00	
Frbp, ped/bikes		1.00	1.00		1.00	0.99		1.00	0.98		1.00	1.00	
Flpb, ped/bikes		1.00	1.00		1.00	1.00		1.00	1.00		1.00	1.00	
Frt		1.00	0.85		1.00	0.85		1.00	0.85		1.00	0.85	
Flt Protected		0.96	1.00		0.98	1.00		1.00	1.00		1.00	1.00	
Satd. Flow (prot)		1396	1378		1501	1227		4771	1123		4818	1205	
Flt Permitted		0.75	1.00		0.86	1.00		1.00	1.00		1.00	1.00	
Satd. Flow (perm)		1080	1378		1310	1227		4771	1123		4818	1205	
Volume (vph)	120	40	80	20	30	80	0	1970	30	0	3750	150	
Peak-hour factor, PHF	0.97	0.97	0.97	0.97	0.97	0.97	0.97	0.97	0.97	0.97	0.97	0.97	
Adj. Flow (vph)	124	41	82	21	31	82	0	2031	31	0	3866	155	
RTOR Reduction (vph)	0	0	1	0	0	20	0	0	8	0	0	34	
Lane Group Flow (vph)	0	165	81	0	52	62	0	2031	23	0	3866	121	
Confl. Peds. (#/hr)	1					1			1	1			
Heavy Vehicles (%)	10%	67%	11%	36%	5%	23%	0%	3%	33%	0%	2%	27%	
Turn Type	Perm		Perm	Perm		Perm			Perm			Perm	
Protected Phases		8			4			6			2		
Permitted Phases	8		8	4		4			6			2	
Actuated Green, G (s)		21.2	21.2		21.2	21.2		88.3	88.3		88.3	88.3	
Effective Green, g (s)		22.7	22.7		22.7	22.7		89.3	89.3		89.3	89.3	
Actuated g/C Ratio		0.19	0.19		0.19	0.19		0.74	0.74		0.74	0.74	
Clearance Time (s)		5.5	5.5		5.5	5.5		5.0	5.0		5.0	5.0	
Vehicle Extension (s)		4.5	4.5		4.5	4.5		4.4	4.4		4.4	4.4	
Lane Grp Cap (vph)		204	261		248	232		3550	836		3585	897	
v/s Ratio Prot								0.43			c0.80		
v/s Ratio Perm		c0.15	0.06		0.04	0.05			0.02			0.10	
v/c Ratio		0.81	0.31		0.21	0.27		0.57	0.03		1.08	0.13	
Uniform Delay, d1		46.6	41.9		41.1	41.5		6.8	4.0		15.4	4.4	
Progression Factor		1.00	1.00		1.00	1.00		1.16	0.44		1.00	1.00	
Incremental Delay, d2		22.5	1.2		0.7	1.1		0.6	0.1		41.2	0.3	
Delay (s)		69.1	43.1		41.8	42.6		8.6	1.8		56.5	4.7	
Level of Service		E	D		D	D		A	A		E	A	
Approach Delay (s)		60.4			42.3			8.5			54.5		
Approach LOS		E			D			A			D		
Intersection Summary													
HCM Average Control Delay			39.8									HCM Level of Service	D
HCM Volume to Capacity ratio			1.02										
Actuated Cycle Length (s)			120.0									Sum of lost time (s)	8.0
Intersection Capacity Utilization			99.0%									ICU Level of Service	F
Analysis Period (min)			15										
c Critical Lane Group													

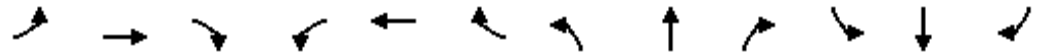


Movement	EBL	EBT	EBR	WBL	WBT	WBR	NBL	NBT	NBR	SBL	SBT	SBR
Lane Configurations		↕	↗		↕	↗		↑↑↑			↑↑↑	
Ideal Flow (vphpl)	1800	1800	1800	1800	1800	1800	1800	1800	1800	1800	1800	1800
Total Lost time (s)		4.0	4.0		4.0	4.0		4.0			4.0	
Lane Util. Factor		1.00	1.00		1.00	1.00		0.86			0.91	
Frbp, ped/bikes		1.00	0.99		1.00	1.00		1.00			1.00	
Flpb, ped/bikes		1.00	1.00		1.00	1.00		1.00			1.00	
Frt		1.00	0.85		1.00	0.85		1.00			1.00	
Flt Protected		0.98	1.00		0.97	1.00		1.00			1.00	
Satd. Flow (prot)		1624	1479		1746	1530		5954			4818	
Flt Permitted		0.87	1.00		0.64	1.00		1.00			1.00	
Satd. Flow (perm)		1443	1479		1145	1530		5954			4818	
Volume (vph)	40	80	110	30	20	40	0	1920	0	0	3850	0
Peak-hour factor, PHF	0.96	0.96	0.96	0.96	0.96	0.96	0.96	0.96	0.96	0.96	0.96	0.96
Adj. Flow (vph)	42	83	115	31	21	42	0	2000	0	0	4010	0
RTOR Reduction (vph)	0	0	1	0	0	36	0	0	0	0	0	0
Lane Group Flow (vph)	0	125	114	0	52	6	0	2000	0	0	4010	0
Confl. Peds. (#/hr)			1	1			1					1
Heavy Vehicles (%)	11%	8%	2%	0%	0%	0%	0%	4%	0%	0%	2%	75%
Turn Type	Perm		Perm	Perm		Perm						
Protected Phases		4			4			6			2	
Permitted Phases	4		4	4	4	4		6				
Actuated Green, G (s)		13.4	13.4		13.4	13.4		98.1			98.1	
Effective Green, g (s)		12.9	12.9		12.9	12.9		99.1			99.1	
Actuated g/C Ratio		0.11	0.11		0.11	0.11		0.83			0.83	
Clearance Time (s)		3.5	3.5		3.5	3.5		5.0			5.0	
Vehicle Extension (s)		2.5	2.5		2.5	2.5		4.5			4.5	
Lane Grp Cap (vph)		155	159		123	164		4917			3979	
v/s Ratio Prot								0.34			c0.83	
v/s Ratio Perm		c0.09	0.08		0.05	0.00						
v/c Ratio		0.81	0.72		0.42	0.04		0.41			1.01	
Uniform Delay, d1		52.3	51.8		50.1	48.0		2.7			10.5	
Progression Factor		1.00	1.00		1.00	1.00		2.90			0.57	
Incremental Delay, d2		24.8	13.4		1.7	0.1		0.2			6.4	
Delay (s)		77.2	65.2		51.8	48.1		8.1			12.4	
Level of Service		E	E		D	D		A			B	
Approach Delay (s)		71.4			50.1			8.1			12.4	
Approach LOS		E			D			A			B	
Intersection Summary												
HCM Average Control Delay			13.8					HCM Level of Service			B	
HCM Volume to Capacity ratio			0.98									
Actuated Cycle Length (s)			120.0					Sum of lost time (s)			8.0	
Intersection Capacity Utilization			101.0%					ICU Level of Service			G	
Analysis Period (min)			15									
c Critical Lane Group												













												
Movement	EBL	EBT	EBR	WBL	WBT	WBR	NBL	NBT	NBR	SBL	SBT	SBR
Lane Configurations												
Ideal Flow (vphpl)	1800	1800	1800	1800	1800	1800	1800	1800	1800	1800	1800	1800
Total Lost time (s)		4.0	4.0	4.0	4.0		4.0	4.0		4.0	4.0	
Lane Util. Factor		1.00	1.00	1.00	1.00		1.00	0.95		1.00	0.95	
Frbp, ped/bikes		1.00	1.00	1.00	1.00		1.00	1.00		1.00	1.00	
Flpb, ped/bikes		1.00	1.00	1.00	1.00		1.00	1.00		1.00	1.00	
Frt		1.00	0.85	1.00	0.95		1.00	0.98		1.00	1.00	
Flt Protected		0.99	1.00	0.95	1.00		0.95	1.00		0.95	1.00	
Satd. Flow (prot)		1583	1733	1676	1478		1840	3337		1800	3539	
Flt Permitted		0.99	1.00	0.95	1.00		0.95	1.00		0.95	1.00	
Satd. Flow (perm)		1583	1733	1676	1478		1840	3337		1800	3539	
Volume (vph)	20	130	580	200	100	50	250	1100	160	180	1990	30
Peak-hour factor, PHF	0.96	0.96	0.96	0.96	0.96	0.96	0.96	0.96	0.96	0.96	0.96	0.96
Adj. Flow (vph)	21	135	604	208	104	52	260	1146	167	188	2073	31
RTOR Reduction (vph)	0	0	10	0	15	0	0	9	0	0	1	0
Lane Group Flow (vph)	0	156	594	208	141	0	260	1304	0	188	2103	0
Conf. Peds. (#/hr)			9	9			8		4	4		8
Conf. Bikes (#/hr)			1									
Heavy Vehicles (%)	0%	15%	1%	2%	17%	13%	2%	4%	0%	3%	4%	7%
Turn Type	Split		pt+ov	Split			Prot			Prot		
Protected Phases	8	8	8 1	4	4		1	6		5	2	
Permitted Phases												
Actuated Green, G (s)		14.0	35.0	12.0	12.0		17.0	63.1		14.4	60.5	
Effective Green, g (s)		14.0	35.0	12.0	12.0		17.0	63.6		14.4	61.0	
Actuated g/C Ratio		0.12	0.29	0.10	0.10		0.14	0.53		0.12	0.51	
Clearance Time (s)		4.0		4.0	4.0		4.0	4.5		4.0	4.5	
Vehicle Extension (s)		2.5		2.5	2.5		2.5	6.0		2.3	6.0	
Lane Grp Cap (vph)		185	505	168	148		261	1769		216	1799	
v/s Ratio Prot		0.10	c0.34	c0.12	0.10		0.14	c0.39		0.10	c0.59	
v/s Ratio Perm												
v/c Ratio		0.84	1.18	1.24	0.95		1.00	0.74		0.87	1.17	
Uniform Delay, d1		51.9	42.5	54.0	53.7		51.5	21.7		51.9	29.5	
Progression Factor		1.00	1.00	1.00	1.00		0.98	0.87		0.85	1.07	
Incremental Delay, d2		27.6	98.5	147.6	59.0		45.5	2.0		12.1	78.3	
Delay (s)		79.5	141.0	201.6	112.7		95.8	21.0		56.3	109.9	
Level of Service		E	F	F	F		F	C		E	F	
Approach Delay (s)		128.4			163.5			33.4			105.5	
Approach LOS		F			F			C			F	
Intersection Summary												
HCM Average Control Delay			90.5				HCM Level of Service				F	
HCM Volume to Capacity ratio			1.21									
Actuated Cycle Length (s)			120.0				Sum of lost time (s)			16.0		
Intersection Capacity Utilization			119.6%				ICU Level of Service			H		
Analysis Period (min)			15									
c Critical Lane Group												

												
Movement	EBL	EBT	EBR	WBL	WBT	WBR	NBL	NBT	NBR	SBL	SBT	SBR
Lane Configurations												
Sign Control		Stop			Stop			Stop			Stop	
Volume (vph)	420	110	80	40	20	20	20	230	40	20	120	210
Peak Hour Factor	0.97	0.97	0.97	0.97	0.97	0.97	0.97	0.97	0.97	0.97	0.97	0.97
Hourly flow rate (vph)	433	113	82	41	21	21	21	237	41	21	124	216
Direction, Lane #	EB 1	EB 2	WB 1	WB 2	NB 1	SB 1	SB 2					
Volume Total (vph)	546	82	62	21	299	144	216					
Volume Left (vph)	433	0	41	0	21	21	0					
Volume Right (vph)	0	82	0	21	41	0	216					
Hadj (s)	0.43	-0.67	0.37	-0.67	-0.03	0.11	-0.67					
Departure Headway (s)	7.2	6.1	8.2	7.2	7.2	7.5	6.7					
Degree Utilization, x	1.10	0.14	0.14	0.04	0.60	0.30	0.40					
Capacity (veh/h)	491	574	407	461	482	469	524					
Control Delay (s)	95.4	8.9	11.4	9.3	20.5	12.4	13.0					
Approach Delay (s)	84.1		10.9		20.5	12.8						
Approach LOS	F		B		C	B						
Intersection Summary												
Delay			47.0									
HCM Level of Service			E									
Intersection Capacity Utilization			67.2%		ICU Level of Service						C	
Analysis Period (min)			15									

													
Movement	EBL	EBT	EBR	WBL	WBT	WBR	NBL	NBT	NBR	SBL	SBT	SBR	
Lane Configurations													
Ideal Flow (vphpl)	1800	1800	1800	1800	1800	1800	1800	1800	1800	1800	1800	1800	
Total Lost time (s)		4.0		4.0	4.0		4.0	4.0		4.0	4.0		
Lane Util. Factor		1.00		1.00	1.00		1.00	0.95		1.00	0.95		
Frbp, ped/bikes		1.00		1.00	0.98		1.00	1.00		1.00	1.00		
Flpb, ped/bikes		1.00		0.99	1.00		1.00	1.00		1.00	1.00		
Frt		0.93		1.00	0.86		1.00	0.98		1.00	1.00		
Flt Protected		1.00		0.95	1.00		0.95	1.00		0.95	1.00		
Satd. Flow (prot)		1646		1665	1485		1676	3224		1644	3351		
Flt Permitted		1.00		0.74	1.00		0.05	1.00		0.95	1.00		
Satd. Flow (perm)		1646		1305	1485		93	3224		1644	3351		
Volume (vph)	0	10	10	250	10	100	10	1350	190	110	2730	10	
Peak-hour factor, PHF	0.97	0.97	0.97	0.98	0.97	0.98	0.97	0.98	0.98	0.98	0.98	0.97	
Adj. Flow (vph)	0	10	10	255	10	102	10	1378	194	112	2786	10	
RTOR Reduction (vph)	0	5	0	0	83	0	0	9	0	0	0	0	
Lane Group Flow (vph)	0	15	0	255	29	0	10	1563	0	112	2796	0	
Confl. Peds. (#/hr)				3		3			2	2			
Heavy Vehicles (%)	2%	2%	2%	2%	2%	3%	2%	4%	2%	4%	2%	2%	
Turn Type	Perm			Perm			Perm			Prot			
Protected Phases		4			8			2		1	6		
Permitted Phases	4			8			2						
Actuated Green, G (s)		22.0		22.0	22.0		75.5	75.5		10.5	90.0		
Effective Green, g (s)		22.0		22.0	22.0		75.5	75.5		10.5	90.0		
Actuated g/C Ratio		0.18		0.18	0.18		0.63	0.63		0.09	0.75		
Clearance Time (s)		4.0		4.0	4.0		4.0	4.0		4.0	4.0		
Vehicle Extension (s)		3.0		3.0	3.0		3.0	3.0		3.0	3.0		
Lane Grp Cap (vph)		302		239	272		59	2028		144	2513		
v/s Ratio Prot		0.01			0.02			0.48		0.07	c0.83		
v/s Ratio Perm				c0.20			0.11						
v/c Ratio		0.05		1.07	0.11		0.17	0.77		0.78	1.11		
Uniform Delay, d1		40.4		49.0	40.8		9.2	16.0		53.6	15.0		
Progression Factor		1.00		1.00	1.00		1.00	1.00		1.01	0.74		
Incremental Delay, d2		0.1		77.1	0.2		6.1	2.9		2.5	51.3		
Delay (s)		40.5		126.1	41.0		15.4	18.9		56.8	62.3		
Level of Service		D		F	D		B	B		E	E		
Approach Delay (s)		40.5			100.1			18.9			62.1		
Approach LOS		D			F			B			E		
Intersection Summary													
HCM Average Control Delay			50.9									HCM Level of Service	D
HCM Volume to Capacity ratio			1.10										
Actuated Cycle Length (s)			120.0									Sum of lost time (s)	8.0
Intersection Capacity Utilization			114.6%									ICU Level of Service	H
Analysis Period (min)			15										
c Critical Lane Group													



Movement	EBL	EBT	EBR	WBL	WBT	WBR	NBL	NBT	NBR	SBL	SBT	SBR
Lane Configurations		↕			↕			↕		↕	↕	↕
Sign Control		Stop			Stop			Stop			Stop	Stop
Volume (vph)	50	280	140	80	200	110	60	90	70	130	100	90
Peak Hour Factor	0.98	0.98	0.98	0.98	0.98	0.98	0.98	0.98	0.98	0.98	0.98	0.98
Hourly flow rate (vph)	51	286	143	82	204	112	61	92	71	133	102	92
Direction, Lane #	EB 1	WB 1	NB 1	SB 1	SB 2							
Volume Total (vph)	480	398	224	133	194							
Volume Left (vph)	51	82	61	133	0							
Volume Right (vph)	143	112	71	0	92							
Hadj (s)	-0.11	-0.06	0.11	0.62	-0.15							
Departure Headway (s)	7.1	7.4	8.5	9.1	8.3							
Degree Utilization, x	0.95	0.82	0.53	0.34	0.45							
Capacity (veh/h)	496	459	401	382	409							
Control Delay (s)	55.7	36.1	20.8	15.5	16.7							
Approach Delay (s)	55.7	36.1	20.8	16.2								
Approach LOS	F	E	C	C								
Intersection Summary												
Delay			35.7									
HCM Level of Service			E									
Intersection Capacity Utilization			74.6%	ICU Level of Service	D							
Analysis Period (min)			15									

						
Movement	WBL	WBR	NBT	NBR	SBL	SBT
Lane Configurations						
Ideal Flow (vphpl)	1800	1800	1800	1800	1800	1800
Total Lost time (s)	4.0	4.0	4.0	4.0	4.0	4.0
Lane Util. Factor	1.00	1.00	1.00	1.00	1.00	1.00
Frbp, ped/bikes	1.00	1.00	1.00	0.97	1.00	1.00
Flpb, ped/bikes	1.00	1.00	1.00	1.00	1.00	1.00
Frt	1.00	0.85	1.00	0.85	1.00	1.00
Flt Protected	0.95	1.00	1.00	1.00	0.95	1.00
Satd. Flow (prot)	1676	1515	1765	1488	1676	1765
Flt Permitted	0.95	1.00	1.00	1.00	0.95	1.00
Satd. Flow (perm)	1676	1515	1765	1488	1676	1765
Volume (vph)	80	370	350	80	550	650
Peak-hour factor, PHF	0.91	0.91	0.91	0.91	0.91	0.91
Adj. Flow (vph)	88	407	385	88	604	714
RTOR Reduction (vph)	0	53	0	39	0	0
Lane Group Flow (vph)	88	354	385	49	604	714
Confl. Peds. (#/hr)				2	2	
Confl. Bikes (#/hr)				1		
Heavy Vehicles (%)	2%	1%	2%	0%	2%	2%
Turn Type	pm+ov		Perm		Prot	
Protected Phases	8	1	2		1	6
Permitted Phases	8		2			
Actuated Green, G (s)	9.6	56.5	40.0	40.0	46.9	91.4
Effective Green, g (s)	10.1	57.5	40.0	40.0	47.4	91.4
Actuated g/C Ratio	0.09	0.53	0.37	0.37	0.43	0.83
Clearance Time (s)	4.5	4.5	4.0	4.0	4.5	4.0
Vehicle Extension (s)	3.0	4.5	2.3	2.3	4.5	2.3
Lane Grp Cap (vph)	155	851	645	544	726	1473
v/s Ratio Prot	c0.05	0.18	c0.22		c0.36	0.40
v/s Ratio Perm		0.05		0.03		
v/c Ratio	0.57	0.42	0.60	0.09	0.83	0.48
Uniform Delay, d1	47.6	15.8	28.2	22.8	27.5	2.5
Progression Factor	1.00	1.00	1.00	1.00	1.00	1.00
Incremental Delay, d2	4.7	0.6	4.0	0.3	8.8	1.1
Delay (s)	52.3	16.4	32.2	23.1	36.3	3.7
Level of Service	D	B	C	C	D	A
Approach Delay (s)	22.8		30.6		18.6	
Approach LOS	C		C		B	
Intersection Summary						
HCM Average Control Delay			22.0	HCM Level of Service		C
HCM Volume to Capacity ratio			0.71			
Actuated Cycle Length (s)			109.5	Sum of lost time (s)		12.0
Intersection Capacity Utilization			69.9%	ICU Level of Service		C
Analysis Period (min)			15			
c Critical Lane Group						























Movement	EBL	EBT	EBR	WBL	WBT	WBR	NBL	NBT	NBR	SBL	SBT	SBR
Lane Configurations		↕↕			↕↕		↕	↕↕	↕	↕	↕↕	↕
Ideal Flow (vphpl)	1800	1800	1800	1800	1800	1800	1800	1800	1800	1800	1800	1800
Total Lost time (s)		4.0			4.0		4.0	4.0	4.0	4.0	4.0	4.0
Lane Util. Factor		0.95			0.95		1.00	0.95	1.00	1.00	0.95	1.00
Frbp, ped/bikes		1.00			1.00		1.00	1.00	0.99	1.00	1.00	0.99
Flpb, ped/bikes		1.00			1.00		1.00	1.00	1.00	1.00	1.00	1.00
Frt		0.97			0.96		1.00	1.00	0.85	1.00	1.00	0.85
Flt Protected		1.00			0.99		0.95	1.00	1.00	0.95	1.00	1.00
Satd. Flow (prot)		2967			3140		1613	3288	1509	1676	3288	1336
Flt Permitted		0.80			0.62		0.95	1.00	1.00	0.95	1.00	1.00
Satd. Flow (perm)		2384			1965		1613	3288	1509	1676	3288	1336
Volume (vph)	20	350	90	80	330	130	100	1050	80	350	2050	20
Peak-hour factor, PHF	0.95	0.95	0.95	0.95	0.95	0.95	0.95	0.95	0.95	0.95	0.95	0.95
Adj. Flow (vph)	21	368	95	84	347	137	105	1105	84	368	2158	21
RTOR Reduction (vph)	0	18	0	0	25	0	0	0	39	0	0	5
Lane Group Flow (vph)	0	466	0	0	543	0	105	1105	45	368	2158	16
Confl. Peds. (#/hr)	3		5	5		3	1		1	1		1
Confl. Bikes (#/hr)						1						
Heavy Vehicles (%)	0%	14%	3%	4%	4%	3%	6%	4%	0%	2%	4%	13%
Turn Type	Perm			Perm			Prot		Perm	Prot		Perm
Protected Phases		4			8		5	2		1	6	
Permitted Phases	4			8					2			6
Actuated Green, G (s)		24.5			24.5		11.5	60.0	60.0	19.0	67.5	67.5
Effective Green, g (s)		26.0			26.0		12.5	62.0	62.0	20.0	69.5	69.5
Actuated g/C Ratio		0.22			0.22		0.10	0.52	0.52	0.17	0.58	0.58
Clearance Time (s)		5.5			5.5		5.0	6.0	6.0	5.0	6.0	6.0
Vehicle Extension (s)		2.5			2.5		2.3	4.0	4.0	2.3	4.0	4.0
Lane Grp Cap (vph)		517			426		168	1699	780	279	1904	774
v/s Ratio Prot							0.07	0.34		c0.22	c0.66	
v/s Ratio Perm		0.20			c0.28				0.03			0.01
v/c Ratio		0.90			1.27		0.62	0.65	0.06	1.32	1.13	0.02
Uniform Delay, d1		45.8			47.0		51.5	21.1	14.4	50.0	25.2	10.8
Progression Factor		1.00			1.00		0.74	1.84	3.53	1.11	0.82	0.80
Incremental Delay, d2		18.8			140.7		5.0	1.7	0.1	160.3	65.2	0.0
Delay (s)		64.5			187.7		43.3	40.6	51.1	215.7	86.1	8.6
Level of Service		E			F		D	D	D	F	F	A
Approach Delay (s)		64.5			187.7			41.5			104.1	
Approach LOS		E			F			D			F	
Intersection Summary												
HCM Average Control Delay			93.4				HCM Level of Service			F		
HCM Volume to Capacity ratio			1.18									
Actuated Cycle Length (s)			120.0				Sum of lost time (s)			8.0		
Intersection Capacity Utilization			112.4%				ICU Level of Service			H		
Analysis Period (min)			15									
c Critical Lane Group												



Movement	EBL	EBT	EBR	WBL	WBT	WBR	NBL	NBT	NBR	SBL	SBT	SBR
Lane Configurations		↕			↕		↗	↕	↗	↗	↕	↗
Ideal Flow (vphpl)	1800	1800	1800	1800	1800	1800	1800	1800	1800	1800	1800	1800
Total Lost time (s)		4.0			4.0		4.0	4.0	4.0	4.0	4.0	4.0
Lane Util. Factor		1.00			1.00		1.00	0.95	1.00	1.00	0.95	1.00
Frbp, ped/bikes		0.98			0.99		1.00	1.00	1.00	1.00	1.00	0.97
Flpb, ped/bikes		1.00			1.00		1.00	1.00	1.00	1.00	1.00	1.00
Frt		0.90			0.95		1.00	1.00	0.85	1.00	1.00	0.85
Flt Protected		1.00			0.98		0.95	1.00	1.00	0.95	1.00	1.00
Satd. Flow (prot)		1560			1641		1710	3320	1530	1541	3320	1413
Flt Permitted		0.97			0.58		0.95	1.00	1.00	0.95	1.00	1.00
Satd. Flow (perm)		1521			962		1710	3320	1530	1541	3320	1413
Volume (vph)	20	40	180	40	40	50	40	1160	10	20	2170	30
Peak-hour factor, PHF	0.94	0.94	0.94	0.94	0.94	0.94	0.94	0.94	0.94	0.94	0.94	0.94
Adj. Flow (vph)	21	43	191	43	43	53	43	1234	11	21	2309	32
RTOR Reduction (vph)	0	54	0	0	21	0	0	0	3	0	0	6
Lane Group Flow (vph)	0	201	0	0	118	0	43	1234	8	21	2309	26
Confl. Peds. (#/hr)	8		4	4		8	4					4
Confl. Bikes (#/hr)			1			2						
Heavy Vehicles (%)	0%	0%	2%	0%	0%	4%	0%	3%	0%	11%	3%	5%
Turn Type	Perm			Perm			Prot		Perm	Prot		Perm
Protected Phases		4			8		5	2		1	6	
Permitted Phases	4			8					2			6
Actuated Green, G (s)		20.5			20.5		6.4	83.7	83.7	2.8	80.1	80.1
Effective Green, g (s)		20.5			20.5		6.4	84.7	84.7	2.8	81.1	81.1
Actuated g/C Ratio		0.17			0.17		0.05	0.71	0.71	0.02	0.68	0.68
Clearance Time (s)		4.0			4.0		4.0	5.0	5.0	4.0	5.0	5.0
Vehicle Extension (s)		3.0			2.5		3.0	5.2	5.2	2.5	5.2	5.2
Lane Grp Cap (vph)		260			164		91	2343	1080	36	2244	955
v/s Ratio Prot							c0.03	c0.37		0.01	c0.70	
v/s Ratio Perm		c0.13			0.12				0.01			0.02
v/c Ratio		0.77			0.72		0.47	0.53	0.01	0.58	1.03	0.03
Uniform Delay, d1		47.5			47.0		55.2	8.3	5.2	58.0	19.5	6.4
Progression Factor		1.00			1.00		0.87	2.40	1.66	0.71	1.58	2.10
Incremental Delay, d2		13.3			13.6		2.6	0.6	0.0	1.8	15.2	0.0
Delay (s)		60.9			60.7		50.4	20.4	8.7	43.2	45.9	13.5
Level of Service		E			E		D	C	A	D	D	B
Approach Delay (s)		60.9			60.7			21.3			45.5	
Approach LOS		E			E			C			D	

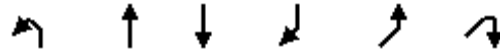
Intersection Summary			
HCM Average Control Delay	39.3	HCM Level of Service	D
HCM Volume to Capacity ratio	0.98		
Actuated Cycle Length (s)	120.0	Sum of lost time (s)	16.0
Intersection Capacity Utilization	90.8%	ICU Level of Service	E
Analysis Period (min)	15		

c Critical Lane Group

												
Movement	NBL	NBT	NBR	SBL	SBT	SBR	SEL	SET	SER	NWL	NWT	NWR
Lane Configurations												
Ideal Flow (vphpl)	1800	1800	1800	1800	1800	1800	1800	1800	1800	1800	1800	1800
Total Lost time (s)		4.0	4.0		4.0	4.0	4.0	4.0	4.0	4.0	4.0	4.0
Lane Util. Factor		0.95	1.00		0.95	1.00	1.00	0.95	1.00	1.00	0.95	1.00
Frbp, ped/bikes		1.00	0.99		1.00	0.98	1.00	1.00	0.99	1.00	1.00	0.99
Flpb, ped/bikes		1.00	1.00		1.00	1.00	1.00	1.00	1.00	1.00	1.00	1.00
Frt		1.00	0.85		1.00	0.85	1.00	1.00	0.85	1.00	1.00	0.85
Flt Protected		1.00	1.00		0.98	1.00	0.95	1.00	1.00	0.95	1.00	1.00
Satd. Flow (prot)		3369	1493		3304	1448	1710	3320	1510	1660	3257	1438
Flt Permitted		0.91	1.00		0.62	1.00	0.95	1.00	1.00	0.95	1.00	1.00
Satd. Flow (perm)		3085	1493		2085	1448	1710	3320	1510	1660	3257	1438
Volume (vph)	20	380	100	140	320	160	310	2020	60	200	1030	130
Peak-hour factor, PHF	0.94	0.94	0.94	0.94	0.94	0.94	0.94	0.94	0.94	0.94	0.94	0.94
Adj. Flow (vph)	21	404	106	149	340	170	330	2149	64	213	1096	138
RTOR Reduction (vph)	0	0	3	0	0	127	0	0	20	0	0	78
Lane Group Flow (vph)	0	425	103	0	489	43	330	2149	44	213	1096	60
Confl. Peds. (#/hr)	1		7	7		1	1		1	1		1
Confl. Bikes (#/hr)						3						
Heavy Vehicles (%)	6%	1%	1%	6%	0%	4%	0%	3%	0%	3%	5%	5%
Turn Type	Perm		pm+ov	Perm		Perm	Prot		Perm	Prot		Perm
Protected Phases		4	5		8		1	6		5	2	
Permitted Phases	4		4	8		8		6				2
Actuated Green, G (s)		29.7	41.2		29.7	29.7	25.3	64.3	64.3	11.5	50.5	50.5
Effective Green, g (s)		30.2	42.2		30.2	30.2	25.8	65.8	65.8	12.0	52.0	52.0
Actuated g/C Ratio		0.25	0.35		0.25	0.25	0.22	0.55	0.55	0.10	0.43	0.43
Clearance Time (s)		4.5	4.5		4.5	4.5	4.5	5.5	5.5	4.5	5.5	5.5
Vehicle Extension (s)		2.5	2.3		2.5	2.5	2.3	5.0	5.0	2.3	5.0	5.0
Lane Grp Cap (vph)		776	575		525	364	368	1820	828	166	1411	623
v/s Ratio Prot			0.02				0.19	c0.65		c0.13	0.34	
v/s Ratio Perm		0.14	0.05		c0.23	0.03			0.03			0.04
v/c Ratio		0.55	0.18		0.94dl	0.12	0.90	1.18	0.05	1.28	0.78	0.10
Uniform Delay, d1		39.0	26.9		43.9	34.6	45.8	27.1	12.6	54.0	29.0	20.1
Progression Factor		1.00	1.00		1.00	1.00	0.91	0.70	0.22	1.09	1.13	2.77
Incremental Delay, d2		0.6	0.1		23.5	0.1	7.0	82.8	0.0	157.0	3.2	0.2
Delay (s)		39.6	27.0		67.4	34.7	48.6	101.7	2.8	216.0	36.0	56.0
Level of Service		D	C		E	C	D	F	A	F	D	E
Approach Delay (s)		37.1			59.0			92.4			64.4	
Approach LOS		D			E			F			E	
Intersection Summary												
HCM Average Control Delay			74.6				HCM Level of Service			E		
HCM Volume to Capacity ratio			1.12									
Actuated Cycle Length (s)			120.0				Sum of lost time (s)			12.0		
Intersection Capacity Utilization			112.4%				ICU Level of Service			H		
Analysis Period (min)			15									
dl Defacto Left Lane. Recode with 1 though lane as a left lane.												
c Critical Lane Group												

Movement	EBL	EBT	EBR	WBL	WBT	WBR	NBL	NBT	NBR	SBL	SBT	SBR
Lane Configurations												
Ideal Flow (vphpl)	1800	1800	1800	1800	1800	1800	1800	1800	1800	1800	1800	1800
Total Lost time (s)	4.0	4.0		4.0	4.0			4.0	4.0		4.0	4.0
Lane Util. Factor	1.00	1.00		1.00	1.00			1.00	1.00		1.00	1.00
Frbp, ped/bikes	1.00	1.00		1.00	1.00			1.00	0.93		1.00	0.99
Flpb, ped/bikes	1.00	1.00		1.00	1.00			1.00	1.00		1.00	1.00
Frt	1.00	1.00		1.00	0.98			1.00	0.85		1.00	0.85
Flt Protected	0.95	1.00		0.95	1.00			0.99	1.00		0.99	1.00
Satd. Flow (prot)	1583	1760		1710	1724			1706	1425		1694	1438
Flt Permitted	0.95	1.00		0.95	1.00			0.91	1.00		0.93	1.00
Satd. Flow (perm)	1583	1760		1710	1724			1571	1425		1591	1438
Volume (vph)	170	580	10	30	250	30	50	230	60	30	190	240
Peak-hour factor, PHF	0.94	0.94	0.94	0.94	0.94	0.94	0.94	0.94	0.94	0.94	0.94	0.94
Adj. Flow (vph)	181	617	11	32	266	32	53	245	64	32	202	255
RTOR Reduction (vph)	0	1	0	0	6	0	0	0	31	0	0	156
Lane Group Flow (vph)	181	627	0	32	292	0	0	298	33	0	234	99
Confl. Peds. (#/hr)	4		4	4		4	1		21	21		1
Confl. Bikes (#/hr)									2			
Heavy Vehicles (%)	8%	2%	0%	0%	2%	6%	7%	4%	0%	0%	6%	5%
Turn Type	Prot			Prot			Perm		Perm	Perm		Perm
Protected Phases	7	4		3	8			2			6	
Permitted Phases							2		2	6		6
Actuated Green, G (s)	10.8	30.8		2.0	22.0			28.2	28.2		28.2	28.2
Effective Green, g (s)	10.8	30.8		2.0	22.0			28.2	28.2		28.2	28.2
Actuated g/C Ratio	0.15	0.42		0.03	0.30			0.39	0.39		0.39	0.39
Clearance Time (s)	4.0	4.0		4.0	4.0			4.0	4.0		4.0	4.0
Vehicle Extension (s)	3.0	3.0		3.0	3.0			3.0	3.0		3.0	3.0
Lane Grp Cap (vph)	234	743		47	520			607	550		615	556
v/s Ratio Prot	c0.11	c0.36		0.02	0.17							
v/s Ratio Perm								c0.19	0.02		0.15	0.07
v/c Ratio	0.77	0.84		0.68	0.56			0.49	0.06		0.38	0.18
Uniform Delay, d1	29.9	18.9		35.2	21.5			17.0	14.1		16.1	14.8
Progression Factor	1.00	1.00		1.00	1.00			1.00	1.00		1.00	1.00
Incremental Delay, d2	14.7	8.7		33.6	1.4			2.8	0.2		1.8	0.7
Delay (s)	44.6	27.7		68.8	22.8			19.8	14.3		17.9	15.5
Level of Service	D	C		E	C			B	B		B	B
Approach Delay (s)		31.4			27.3			18.8			16.6	
Approach LOS		C			C			B			B	
Intersection Summary												
HCM Average Control Delay			24.8			HCM Level of Service				C		
HCM Volume to Capacity ratio			0.66									
Actuated Cycle Length (s)			73.0			Sum of lost time (s)			8.0			
Intersection Capacity Utilization			78.6%			ICU Level of Service				D		
Analysis Period (min)			15									














c Critical Lane Group



Movement	NBL	NBT	SBT	SBR	NEL	NER
Lane Configurations		↑↑	↑↑			↗
Sign Control		Free	Free		Stop	
Grade		0%	0%		0%	
Volume (veh/h)	0	1550	2350	640	0	10
Peak Hour Factor	0.96	0.96	0.96	0.96	0.96	0.96
Hourly flow rate (vph)	0	1615	2448	667	0	10
Pedestrians					1	
Lane Width (ft)					12.0	
Walking Speed (ft/s)					4.0	
Percent Blockage					0	
Right turn flare (veh)						
Median type					None	
Median storage (veh)						
Upstream signal (ft)		507				
pX, platoon unblocked					0.96	
vC, conflicting volume	3116				3590	1558
vC1, stage 1 conf vol						
vC2, stage 2 conf vol						
vCu, unblocked vol	3116				3649	1558
tC, single (s)	4.1				6.8	7.0
tC, 2 stage (s)						
tF (s)	2.2				3.5	3.3
p0 queue free %	100				100	90
cM capacity (veh/h)	105				4	100

Direction, Lane #	NB 1	NB 2	SB 1	SB 2	NE 1
Volume Total	807	807	1632	1483	10
Volume Left	0	0	0	0	0
Volume Right	0	0	0	667	10
cSH	1700	1700	1700	1700	100
Volume to Capacity	0.47	0.47	0.96	0.87	0.10
Queue Length 95th (ft)	0	0	0	0	8
Control Delay (s)	0.0	0.0	0.0	0.0	45.0
Lane LOS					E
Approach Delay (s)	0.0		0.0		45.0
Approach LOS					E

Intersection Summary					
Average Delay			0.1		
Intersection Capacity Utilization		100.2%		ICU Level of Service	G
Analysis Period (min)			15		






















						
Movement	NBL	NBR	SET	SER	NWL	NWT
Lane Configurations			 			 
Ideal Flow (vphpl)	1800	1800	1800	1800	1800	1800
Total Lost time (s)	4.0	4.0	4.0		4.0	4.0
Lane Util. Factor	1.00	1.00	0.95		1.00	0.95
Frt	1.00	0.85	1.00		1.00	1.00
Flt Protected	0.95	1.00	1.00		0.95	1.00
Satd. Flow (prot)	1660	1530	3353		1583	3353
Flt Permitted	0.95	1.00	1.00		0.95	1.00
Satd. Flow (perm)	1660	1530	3353		1583	3353
Volume (vph)	300	60	2360	0	20	1250
Peak-hour factor, PHF	0.91	0.91	0.91	0.91	0.91	0.91
Adj. Flow (vph)	330	66	2593	0	22	1374
RTOR Reduction (vph)	0	23	0	0	0	0
Lane Group Flow (vph)	330	43	2593	0	22	1374
Heavy Vehicles (%)	3%	0%	2%	0%	8%	2%
Turn Type		Prot			Prot	
Protected Phases	7	7	6		5	
Permitted Phases			6			2 7
Actuated Green, G (s)	28.1	28.1	97.4		4.7	139.2
Effective Green, g (s)	28.1	28.1	98.4		4.7	139.2
Actuated g/C Ratio	0.19	0.19	0.66		0.03	0.93
Clearance Time (s)	4.0	4.0	5.0		4.0	
Vehicle Extension (s)	2.3	2.3	8.0		2.3	
Lane Grp Cap (vph)	312	288	2208		50	3124
v/s Ratio Prot	c0.20	0.03	c0.77		0.01	
v/s Ratio Perm						c0.41
v/c Ratio	1.06	0.15	1.17		0.44	0.44
Uniform Delay, d1	60.6	50.7	25.5		71.1	0.6
Progression Factor	1.00	1.00	1.00		1.00	1.00
Incremental Delay, d2	67.0	0.1	83.6		3.6	0.1
Delay (s)	127.6	50.8	109.1		74.6	0.6
Level of Service	F	D	F		E	A
Approach Delay (s)	114.8		109.1			1.8
Approach LOS	F		F			A

Intersection Summary

HCM Average Control Delay	75.5	HCM Level of Service	E
HCM Volume to Capacity ratio	1.13		
Actuated Cycle Length (s)	149.4	Sum of lost time (s)	18.2
Intersection Capacity Utilization	93.1%	ICU Level of Service	F
Analysis Period (min)	15		

c Critical Lane Group

Movement	EBL	EBT	EBR	WBL	WBT	WBR	NBL	NBT	NBR	SBL	SBT	SBR
Lane Configurations												
Ideal Flow (vphpl)	1800	1800	1800	1800	1800	1800	1800	1800	1800	1800	1800	1800
Total Lost time (s)	4.0	4.0		4.0	4.0		4.0	4.0		4.0	4.0	
Lane Util. Factor	1.00	1.00		1.00	1.00		1.00	1.00		1.00	1.00	
Frbp, ped/bikes	1.00	1.00		1.00	1.00		1.00	0.98		1.00	1.00	
Flpb, ped/bikes	1.00	1.00		1.00	1.00		1.00	1.00		1.00	1.00	
Frt	1.00	0.94		1.00	0.98		1.00	0.90		1.00	0.99	
Flt Protected	0.95	1.00		0.95	1.00		0.95	1.00		0.95	1.00	
Satd. Flow (prot)	1676	1669		1710	1755		1710	1585		1613	1738	
Flt Permitted	0.95	1.00		0.95	1.00		0.95	1.00		0.95	1.00	
Satd. Flow (perm)	1676	1669		1710	1755		1710	1585		1613	1738	
Volume (vph)	30	230	160	360	150	30	80	120	280	50	200	20
Peak-hour factor, PHF	0.97	0.97	0.97	0.97	0.97	0.97	0.97	0.97	0.97	0.97	0.97	0.97
Adj. Flow (vph)	31	237	165	371	155	31	82	124	289	52	206	21
RTOR Reduction (vph)	0	27	0	0	8	0	0	92	0	0	4	0
Lane Group Flow (vph)	31	375	0	371	178	0	82	321	0	52	223	0
Confl. Peds. (#/hr)							1		1	1		1
Heavy Vehicles (%)	2%	0%	3%	0%	0%	0%	0%	0%	0%	6%	0%	21%
Turn Type	Prot			Prot			Prot			Prot		
Protected Phases	7	4		3	8		5	2		1	6	
Permitted Phases												
Actuated Green, G (s)	3.4	22.9		20.5	40.0		5.3	25.4		3.0	23.1	
Effective Green, g (s)	3.4	22.9		20.5	40.0		5.3	25.4		3.0	23.1	
Actuated g/C Ratio	0.04	0.26		0.23	0.46		0.06	0.29		0.03	0.26	
Clearance Time (s)	4.0	4.0		4.0	4.0		4.0	4.0		4.0	4.0	
Vehicle Extension (s)	3.0	3.0		3.0	3.0		3.0	3.0		3.0	3.0	
Lane Grp Cap (vph)	65	435		399	800		103	459		55	457	
v/s Ratio Prot	0.02	c0.22		c0.22	0.10		c0.05	c0.20		0.03	0.13	
v/s Ratio Perm												
v/c Ratio	0.48	0.86		0.93	0.22		0.80	0.70		0.95	0.49	
Uniform Delay, d1	41.3	30.9		32.9	14.5		40.7	27.8		42.3	27.4	
Progression Factor	1.00	1.00		1.00	1.00		1.00	1.00		1.00	1.00	
Incremental Delay, d2	5.4	15.9		27.7	0.1		33.3	8.6		100.6	3.7	
Delay (s)	46.8	46.8		60.7	14.6		74.1	36.4		142.9	31.1	
Level of Service	D	D		E	B		E	D		F	C	
Approach Delay (s)		46.8			45.3			42.6			51.9	
Approach LOS		D			D			D			D	
Intersection Summary												
HCM Average Control Delay			46.0			HCM Level of Service				D		
HCM Volume to Capacity ratio			0.79									
Actuated Cycle Length (s)			87.8			Sum of lost time (s)			12.0			
Intersection Capacity Utilization			85.7%			ICU Level of Service				E		
Analysis Period (min)			15									
c Critical Lane Group												

												
Movement	EBL	EBT	EBR	WBL	WBT	WBR	NBL	NBT	NBR	SBL	SBT	SBR
Lane Configurations												
Ideal Flow (vphpl)	1800	1800	1800	1800	1800	1800	1800	1800	1800	1800	1800	1800
Total Lost time (s)		4.0			4.0	4.0	4.0	4.0	4.0	4.0	4.0	4.0
Lane Util. Factor		1.00			1.00	1.00	1.00	0.95	1.00	1.00	0.95	1.00
Frbp, ped/bikes		1.00			1.00	1.00	1.00	1.00	0.98	1.00	1.00	0.98
Flpb, ped/bikes		1.00			1.00	1.00	1.00	1.00	1.00	1.00	1.00	1.00
Frt		0.96			1.00	0.85	1.00	1.00	0.85	1.00	1.00	0.85
Flt Protected		0.99			0.97	1.00	0.95	1.00	1.00	0.95	1.00	1.00
Satd. Flow (prot)		1711			1699	1515	1710	3420	1466	1613	3420	1235
Flt Permitted		0.77			0.65	1.00	0.95	1.00	1.00	0.95	1.00	1.00
Satd. Flow (perm)		1340			1142	1515	1710	3420	1466	1613	3420	1235
Volume (vph)	30	70	40	180	100	150	50	1180	90	130	2100	30
Peak-hour factor, PHF	0.94	0.94	0.94	0.94	0.94	0.94	0.94	0.94	0.94	0.94	0.94	0.94
Adj. Flow (vph)	32	74	43	191	106	160	53	1255	96	138	2234	32
RTOR Reduction (vph)	0	12	0	0	0	117	0	0	47	0	0	7
Lane Group Flow (vph)	0	137	0	0	297	43	53	1255	49	138	2234	25
Confl. Peds. (#/hr)							1		1	1		1
Heavy Vehicles (%)	0%	0%	0%	3%	2%	1%	0%	0%	2%	6%	0%	21%
Turn Type	Perm			Perm		Perm	Prot		Perm	Prot		Perm
Protected Phases		4			4		5	2		1		6
Permitted Phases	4			4		4			2			6
Actuated Green, G (s)		32.1			32.1	32.1	4.5	60.2	60.2	14.2	69.9	69.9
Effective Green, g (s)		32.1			32.1	32.1	4.5	61.7	61.7	14.2	71.4	71.4
Actuated g/C Ratio		0.27			0.27	0.27	0.04	0.51	0.51	0.12	0.60	0.60
Clearance Time (s)		4.0			4.0	4.0	4.0	5.5	5.5	4.0	5.5	5.5
Vehicle Extension (s)		2.5			2.5	2.5	0.5	4.6	4.6	2.5	2.6	2.6
Lane Grp Cap (vph)		358			305	405	64	1758	754	191	2035	735
v/s Ratio Prot							0.03	c0.37		0.09	c0.65	
v/s Ratio Perm		0.10			c0.26	0.03			0.03			0.02
v/c Ratio		0.38			0.97	0.11	0.83	0.71	0.07	0.72	1.10	0.03
Uniform Delay, d1		35.9			43.5	33.1	57.4	22.4	14.7	51.0	24.3	10.0
Progression Factor		1.00			1.00	1.00	0.67	1.57	3.68	1.11	1.26	0.75
Incremental Delay, d2		0.5			44.1	0.1	43.5	1.9	0.1	1.2	44.9	0.0
Delay (s)		36.3			87.6	33.2	82.1	37.1	54.1	57.8	75.4	7.6
Level of Service		D			F	C	F	D	D	E	E	A
Approach Delay (s)		36.3			68.6			39.9			73.5	
Approach LOS		D			E			D			E	
Intersection Summary												
HCM Average Control Delay			61.1									HCM Level of Service E
HCM Volume to Capacity ratio			1.05									
Actuated Cycle Length (s)			120.0									Sum of lost time (s) 12.0
Intersection Capacity Utilization			97.3%									ICU Level of Service F
Analysis Period (min)			15									
c Critical Lane Group												

Movement	EBL	EBT	EBR	WBL	WBT	WBR	NBL	NBT	NBR	SBL	SBT	SBR
Lane Configurations												
Ideal Flow (vphpl)	1800	1800	1800	1800	1800	1800	1800	1800	1800	1800	1800	1800
Total Lost time (s)	4.0	4.0	4.0	4.0	4.0	4.0		4.0			4.0	4.0
Lane Util. Factor	1.00	0.95	1.00	1.00	0.95	1.00		1.00			1.00	1.00
Frt	1.00	1.00	0.85	1.00	1.00	0.85		0.96			1.00	0.85
Flt Protected	0.95	1.00	1.00	0.95	1.00	1.00		0.98			0.96	1.00
Satd. Flow (prot)	1660	3196	1530	1660	3257	1404		1702			1696	1471
Flt Permitted	0.95	1.00	1.00	0.95	1.00	1.00		0.62			0.64	1.00
Satd. Flow (perm)	1660	3196	1530	1660	3257	1404		1079			1139	1471
Volume (vph)	60	2210	50	30	1200	120	40	40	30	250	40	80
Peak-hour factor, PHF	0.92	0.92	0.92	0.92	0.92	0.92	0.92	0.92	0.92	0.92	0.92	0.92
Adj. Flow (vph)	65	2402	54	33	1304	130	43	43	33	272	43	87
RTOR Reduction (vph)	0	0	12	0	0	50	0	12	0	0	0	64
Lane Group Flow (vph)	65	2402	42	33	1304	80	0	107	0	0	315	23
Heavy Vehicles (%)	3%	7%	0%	3%	5%	9%	0%	0%	0%	2%	0%	4%
Turn Type	Prot		Perm	Prot		Perm	Perm			Perm		Perm
Protected Phases	5	2		1	6			8			4	
Permitted Phases			2			6	8			4		4
Actuated Green, G (s)	9.2	71.8	71.8	2.7	65.3	65.3		32.0			32.0	32.0
Effective Green, g (s)	9.2	73.3	73.3	2.7	66.8	66.8		32.0			32.0	32.0
Actuated g/C Ratio	0.08	0.61	0.61	0.02	0.56	0.56		0.27			0.27	0.27
Clearance Time (s)	4.0	5.5	5.5	4.0	5.5	5.5		4.0			4.0	4.0
Vehicle Extension (s)	2.5	4.6	4.6	2.5	4.6	4.6		3.0			3.0	3.0
Lane Grp Cap (vph)	127	1952	935	37	1813	782		288			304	392
v/s Ratio Prot	0.04	c0.75		0.02	c0.40							
v/s Ratio Perm			0.03			0.06		0.10			c0.28	0.02
v/c Ratio	0.51	1.23	0.04	0.89	0.72	0.10		0.37			1.04	0.06
Uniform Delay, d1	53.2	23.4	9.3	58.5	19.7	12.5		35.8			44.0	32.8
Progression Factor	1.27	1.64	2.02	1.00	1.00	1.00		1.00			1.00	1.00
Incremental Delay, d2	0.2	104.2	0.0	104.7	2.5	0.3		0.8			61.3	0.1
Delay (s)	68.0	142.4	18.9	163.2	22.2	12.8		36.6			105.3	32.8
Level of Service	E	F	B	F	C	B		D			F	C
Approach Delay (s)		137.9			24.5			36.6			89.6	
Approach LOS		F			C			D			F	

Intersection Summary

HCM Average Control Delay	94.0	HCM Level of Service	F
HCM Volume to Capacity ratio	1.17		
Actuated Cycle Length (s)	120.0	Sum of lost time (s)	12.0
Intersection Capacity Utilization	94.7%	ICU Level of Service	F
Analysis Period (min)	15		

c Critical Lane Group



















Movement	EBL	EBT	WBT	WBR	WBR2	SBL	SBR	SWL	SWR
Lane Configurations	↘	↑	↑			↘			
Ideal Flow (vphpl)	1800	1800	1800	1800	1800	1800	1800	1800	1800
Total Lost time (s)	4.0	4.0	4.0			4.0			
Lane Util. Factor	1.00	1.00	1.00			1.00			
Frt	1.00	1.00	0.97			0.99			
Flt Protected	0.95	1.00	1.00			0.96			
Satd. Flow (prot)	1555	1765	1704			1672			
Flt Permitted	0.95	1.00	1.00			0.96			
Satd. Flow (perm)	1555	1765	1704			1672			
Volume (vph)	150	480	600	0	150	240	20	0	0
Peak-hour factor, PHF	0.92	0.92	0.92	0.92	0.92	0.92	0.92	0.92	0.92
Adj. Flow (vph)	163	522	652	0	163	261	22	0	0
RTOR Reduction (vph)	0	0	9	0	0	3	0	0	0
Lane Group Flow (vph)	163	522	806	0	0	280	0	0	0
Heavy Vehicles (%)	10%	2%	3%	0%	2%	2%	0%	0%	0%
Turn Type	Prot								
Protected Phases	5	2	6			4			
Permitted Phases									
Actuated Green, G (s)	13.0	57.9	40.9			16.6			
Effective Green, g (s)	13.0	58.9	41.9			16.6			
Actuated g/C Ratio	0.16	0.71	0.50			0.20			
Clearance Time (s)	4.0	5.0	5.0			4.0			
Vehicle Extension (s)	3.0	3.0	3.0			3.0			
Lane Grp Cap (vph)	242	1245	855			332			
v/s Ratio Prot	c0.10	0.30	c0.47			c0.17			
v/s Ratio Perm									
v/c Ratio	0.67	0.42	0.94			0.84			
Uniform Delay, d1	33.2	5.1	19.7			32.2			
Progression Factor	1.00	1.00	1.00			1.00			
Incremental Delay, d2	7.2	0.2	18.2			17.4			
Delay (s)	40.4	5.4	37.9			49.6			
Level of Service	D	A	D			D			
Approach Delay (s)		13.7	37.9			49.6		0.0	
Approach LOS		B	D			D		A	

Intersection Summary

HCM Average Control Delay	30.5	HCM Level of Service	C
HCM Volume to Capacity ratio	0.87		
Actuated Cycle Length (s)	83.5	Sum of lost time (s)	12.0
Intersection Capacity Utilization	77.0%	ICU Level of Service	D
Analysis Period (min)	15		

c Critical Lane Group

												
Movement	EBL	EBT	EBR	WBL	WBT	WBR	NBL	NBT	NBR	SBL	SBT	SBR
Lane Configurations												
Sign Control		Free			Free			Stop			Stop	
Grade		0%			0%			0%			0%	
Volume (veh/h)	20	400	60	70	350	30	30	20	80	20	10	10
Peak Hour Factor	0.97	0.97	0.97	0.97	0.97	0.97	0.97	0.97	0.97	0.97	0.97	0.97
Hourly flow rate (vph)	21	412	62	72	361	31	31	21	82	21	10	10
Pedestrians												
Lane Width (ft)												
Walking Speed (ft/s)												
Percent Blockage												
Right turn flare (veh)												
Median type								None			None	
Median storage (veh)												
Upstream signal (ft)												
pX, platoon unblocked												
vC, conflicting volume	392			474			1021	1021	443	1098	1036	376
vC1, stage 1 conf vol												
vC2, stage 2 conf vol												
vCu, unblocked vol	392			474			1021	1021	443	1098	1036	376
tC, single (s)	4.1			4.1			7.1	6.5	6.2	7.1	6.5	6.2
tC, 2 stage (s)												
tF (s)	2.2			2.2			3.5	4.0	3.3	3.5	4.0	3.3
p0 queue free %	98			93			84	90	87	86	95	98
cM capacity (veh/h)	1167			1088			191	217	614	143	212	670
Direction, Lane #	EB 1	WB 1	NB 1	SB 1								
Volume Total	495	464	134	41								
Volume Left	21	72	31	21								
Volume Right	62	31	82	10								
cSH	1167	1088	342	198								
Volume to Capacity	0.02	0.07	0.39	0.21								
Queue Length 95th (ft)	1	5	45	19								
Control Delay (s)	0.5	2.0	22.1	27.9								
Lane LOS	A	A	C	D								
Approach Delay (s)	0.5	2.0	22.1	27.9								
Approach LOS			C	D								
Intersection Summary												
Average Delay			4.7									
Intersection Capacity Utilization			67.1%		ICU Level of Service				C			
Analysis Period (min)			15									



Movement	WBL	WBR	NBL	NBR	SEL	SER
Lane Configurations	W		W		W	
Sign Control	Stop		Stop		Stop	
Volume (vph)	80	390	160	100	650	390
Peak Hour Factor	0.97	0.97	0.97	0.97	0.97	0.97
Hourly flow rate (vph)	82	402	165	103	670	402
Direction, Lane #	WB 1	NB 1	SE 1			
Volume Total (vph)	485	268	1072			
Volume Left (vph)	82	0	670			
Volume Right (vph)	402	103	0			
Hadj (s)	-0.43	-0.20	0.16			
Departure Headway (s)	5.9	6.3	6.2			
Degree Utilization, x	0.80	0.47	1.84			
Capacity (veh/h)	598	539	587			
Control Delay (s)	28.1	14.9	401.0			
Approach Delay (s)	28.1	14.9	401.0			
Approach LOS	D	B	F			
Intersection Summary						
Delay			245.2			
HCM Level of Service			F			
Intersection Capacity Utilization		119.1%		ICU Level of Service		H
Analysis Period (min)			15			



Movement	EBL	EBT	EBR	WBL	WBT	WBR	NBL	NBT	NBR	SBL	SBT	SBR
Lane Configurations												
Ideal Flow (vphpl)	1800	1800	1800	1800	1800	1800	1800	1800	1800	1800	1800	1800
Total Lost time (s)	4.0	4.0		4.0	4.0		4.0	4.0		4.0	4.0	
Lane Util. Factor	1.00	1.00		1.00	1.00		1.00	1.00		1.00	1.00	
Frbp, ped/bikes	1.00	0.99		1.00	1.00		1.00	0.99		1.00	0.99	
Flpb, ped/bikes	1.00	1.00		1.00	1.00		1.00	1.00		1.00	1.00	
Frt	1.00	0.97		1.00	0.97		1.00	0.95		1.00	0.98	
Flt Protected	0.95	1.00		0.95	1.00		0.95	1.00		0.95	1.00	
Satd. Flow (prot)	1629	1660		1660	1681		1676	1666		1613	1699	
Flt Permitted	0.13	1.00		0.06	1.00		0.95	1.00		0.95	1.00	
Satd. Flow (perm)	229	1660		104	1681		1676	1666		1613	1699	
Volume (vph)	80	660	140	200	620	140	120	260	150	90	260	50
Peak-hour factor, PHF	0.91	0.91	0.91	0.91	0.91	0.91	0.91	0.91	0.91	0.91	0.91	0.91
Adj. Flow (vph)	88	725	154	220	681	154	132	286	165	99	286	55
RTOR Reduction (vph)	0	10	0	0	6	0	0	16	0	0	5	0
Lane Group Flow (vph)	88	869	0	220	829	0	132	435	0	99	336	0
Confl. Peds. (#/hr)	1		7	7		1	11		2	2		11
Confl. Bikes (#/hr)			2						1			
Heavy Vehicles (%)	5%	5%	3%	3%	4%	2%	2%	1%	1%	6%	1%	9%
Turn Type	pm+pt			pm+pt			Prot			Prot		
Protected Phases	7	4		3	8		5	2		1	6	
Permitted Phases	4			8								
Actuated Green, G (s)	67.0	63.0		79.0	71.0		11.0	31.0		8.0	28.0	
Effective Green, g (s)	67.0	63.0		79.0	71.0		11.0	31.0		8.0	28.0	
Actuated g/C Ratio	0.52	0.48		0.61	0.55		0.08	0.24		0.06	0.22	
Clearance Time (s)	4.0	4.0		4.0	4.0		4.0	4.0		4.0	4.0	
Vehicle Extension (s)	3.0	3.0		3.0	3.0		3.0	3.0		3.0	3.0	
Lane Grp Cap (vph)	161	804		207	918		142	397		99	366	
v/s Ratio Prot	0.02	0.52		c0.10	0.49		c0.08	c0.26		0.06	0.20	
v/s Ratio Perm	0.26			c0.55								
v/c Ratio	0.55	1.08		1.06	0.90		0.93	1.10		1.00	0.92	
Uniform Delay, d1	23.0	33.5		43.8	26.4		59.1	49.5		61.0	49.9	
Progression Factor	1.00	1.00		1.00	1.00		1.00	1.00		1.00	1.00	
Incremental Delay, d2	3.8	55.7		80.1	12.0		54.0	73.5		90.5	30.0	
Delay (s)	26.8	89.2		123.9	38.4		113.1	123.0		151.5	79.9	
Level of Service	C	F		F	D		F	F		F	E	
Approach Delay (s)		83.6			56.2			120.8			96.0	
Approach LOS		F			E			F			F	

Intersection Summary			
HCM Average Control Delay	83.0	HCM Level of Service	F
HCM Volume to Capacity ratio	1.06		
Actuated Cycle Length (s)	130.0	Sum of lost time (s)	12.0
Intersection Capacity Utilization	100.2%	ICU Level of Service	G
Analysis Period (min)	15		

c Critical Lane Group

Movement	EBL	EBT	EBR	WBL	WBT	WBR	NBL	NBT	NBR	SBL	SBT	SBR
Lane Configurations												
Ideal Flow (vphpl)	1800	1800	1800	1800	1800	1800	1800	1800	1800	1800	1800	1800
Total Lost time (s)	4.0	4.0		4.0	4.0		4.0	4.0		4.0	4.0	
Lane Util. Factor	1.00	1.00		1.00	1.00		1.00	1.00		1.00	1.00	
Frbp, ped/bikes	1.00	0.99		1.00	1.00		1.00	0.99		1.00	0.99	
Flpb, ped/bikes	1.00	1.00		1.00	1.00		1.00	1.00		1.00	1.00	
Frt	1.00	0.98		1.00	0.98		1.00	0.96		1.00	0.98	
Flt Protected	0.95	1.00		0.95	1.00		0.95	1.00		0.95	1.00	
Satd. Flow (prot)	1693	1709		1676	1708		1644	1652		1710	1676	
Flt Permitted	0.95	1.00		0.95	1.00		0.95	1.00		0.95	1.00	
Satd. Flow (perm)	1693	1709		1676	1708		1644	1652		1710	1676	
Volume (vph)	180	480	80	220	340	50	90	310	120	80	420	80
Peak-hour factor, PHF	0.95	0.95	0.95	0.95	0.95	0.95	0.95	0.95	0.95	0.95	0.95	0.95
Adj. Flow (vph)	189	505	84	232	358	53	95	326	126	84	442	84
RTOR Reduction (vph)	0	5	0	0	5	0	0	11	0	0	5	0
Lane Group Flow (vph)	189	584	0	232	406	0	95	441	0	84	521	0
Confl. Peds. (#/hr)	4		12	12		4	5		6	6		5
Confl. Bikes (#/hr)			1									1
Heavy Vehicles (%)	1%	2%	3%	2%	3%	2%	4%	4%	1%	0%	4%	5%
Turn Type	Prot		Prot		Prot		Prot		Prot			
Protected Phases	7	4		3	8		5	2		1	6	
Permitted Phases												
Actuated Green, G (s)	16.0	41.0		17.0	42.0		7.0	40.0		6.0	39.0	
Effective Green, g (s)	16.0	41.0		17.0	42.0		7.0	40.0		6.0	39.0	
Actuated g/C Ratio	0.13	0.34		0.14	0.35		0.06	0.33		0.05	0.32	
Clearance Time (s)	4.0	4.0		4.0	4.0		4.0	4.0		4.0	4.0	
Vehicle Extension (s)	3.0	3.0		3.0	3.0		3.0	3.0		3.0	3.0	
Lane Grp Cap (vph)	226	584		237	598		96	551		86	545	
v/s Ratio Prot	0.11	c0.34		c0.14	0.24		c0.06	0.27		0.05	c0.31	
v/s Ratio Perm												
v/c Ratio	0.84	1.00		0.98	0.68		0.99	0.80		0.98	0.96	
Uniform Delay, d1	50.7	39.5		51.3	33.3		56.5	36.4		56.9	39.6	
Progression Factor	1.00	1.00		1.00	1.00		1.00	1.00		1.00	1.00	
Incremental Delay, d2	22.7	36.8		51.9	3.1		87.6	11.6		88.5	28.9	
Delay (s)	73.4	76.3		103.2	36.3		144.1	47.9		145.4	68.6	
Level of Service	E	E		F	D		F	D		F	E	
Approach Delay (s)		75.6			60.5			64.6			79.2	
Approach LOS		E			E			E			E	
Intersection Summary												
HCM Average Control Delay			70.3			HCM Level of Service		E				
HCM Volume to Capacity ratio			0.98									
Actuated Cycle Length (s)			120.0			Sum of lost time (s)		16.0				
Intersection Capacity Utilization			92.0%			ICU Level of Service		F				
Analysis Period (min)			15									
c Critical Lane Group												



Movement	EBL	EBT	WBT	WBR	SBL	SBR
Lane Configurations	↵	↑↑	↑↑	↵	↵↵	↵
Ideal Flow (vphpl)	1800	1800	1800	1800	1800	1800
Total Lost time (s)	4.0	4.0	4.0	4.0	4.0	4.0
Lane Util. Factor	1.00	0.95	0.95	1.00	0.97	1.00
Frbp, ped/bikes	1.00	1.00	1.00	1.00	1.00	1.00
Flpb, ped/bikes	1.00	1.00	1.00	1.00	1.00	1.00
Frt	1.00	1.00	1.00	0.85	1.00	0.85
Flt Protected	0.95	1.00	1.00	1.00	0.95	1.00
Satd. Flow (prot)	1676	3353	3353	1500	3252	1500
Flt Permitted	0.95	1.00	1.00	1.00	0.95	1.00
Satd. Flow (perm)	1676	3353	3353	1500	3252	1500
Volume (vph)	380	650	420	610	710	460
Peak-hour factor, PHF	0.90	0.90	0.90	0.90	0.90	0.90
Adj. Flow (vph)	422	722	467	678	789	511
RTOR Reduction (vph)	0	0	0	523	0	339
Lane Group Flow (vph)	422	722	467	155	789	172
Confl. Bikes (#/hr)		1				
Turn Type	Prot			Perm		Prot
Protected Phases	6	1 6	5		8	8
Permitted Phases		1		5		
Actuated Green, G (s)	28.0	53.5	20.5	20.5	30.7	30.7
Effective Green, g (s)	29.0	54.5	21.5	21.5	31.7	31.7
Actuated g/C Ratio	0.31	0.58	0.23	0.23	0.34	0.34
Clearance Time (s)	5.0		5.0	5.0	5.0	5.0
Vehicle Extension (s)	3.0		3.0	3.0	3.0	3.0
Lane Grp Cap (vph)	516	1940	765	342	1094	505
v/s Ratio Prot	c0.25	0.22	c0.14		c0.24	0.11
v/s Ratio Perm				0.10		
v/c Ratio	0.82	0.37	0.61	0.45	0.72	0.34
Uniform Delay, d1	30.2	10.7	32.6	31.3	27.4	23.4
Progression Factor	1.00	1.00	1.00	1.00	1.00	1.00
Incremental Delay, d2	9.7	0.1	1.4	1.0	2.4	0.4
Delay (s)	39.9	10.8	34.0	32.2	29.8	23.8
Level of Service	D	B	C	C	C	C
Approach Delay (s)		21.5	33.0		27.4	
Approach LOS		C	C		C	

Intersection Summary

HCM Average Control Delay	27.3	HCM Level of Service	C
HCM Volume to Capacity ratio	0.73		
Actuated Cycle Length (s)	94.2	Sum of lost time (s)	12.0
Intersection Capacity Utilization	68.8%	ICU Level of Service	C
Analysis Period (min)	15		

c Critical Lane Group

**Milwaukie Transportation System Plan 2006 PM Peak Hour Traffic Counts
Peak Hour Traffic Signal Warrant Analysis**

No.	Intersection	Urban (1) or Rural (2)*	Major Street Lanes (1 or 2)	Minor Street Lanes (1 or 2)	Major Volume	Minor TH and LT Volume	Minor RT Volume	RT Reduction	Minor Volume	Warrant Volume	Warrant Met?
1	SE 42nd Avenue @ SE Harrison Street	1	1	1	440	366	70	1.00	366	446	No
2	SE Harrison Street @ SE Main Street	1	1	1	655	175	66	1.00	175	349	No
4	SE Mcloughlin Boulevard @ SE 22nd Avenue	1	1	1	3570	0	1	1.00	0	100	No
5	SE 21st street @ SE Harrison Street	1	1	1	703	49	75	1.00	49	327	No
6	SE 32nd Avenue @ SE Johnson Creek Boulevard	1	1	1	966	60	362	0.13	375	216	Yes

**Milwaukie Transportation System Plan 2030 PM Peak Hour Traffic Forecasts
Peak Hour Traffic Signal Warrant Analysis**

No.	Intersection	Urban (1) or Rural (2)*	Major Street Lanes (1 or 2)	Minor Street Lanes (1 or 2)	Major Volume	Minor TH and LT Volume	Minor RT Volume	RT Reduction	Minor Volume	Warrant Volume	Warrant Met?
1	SE 42nd Avenue @ SE Harrison Street	1	1	1	640	530	80	0.00	610	353	Yes
2	SE Harrison Street @ SE Main Street	1	1	1	860	230	90	1.00	230	256	No
4	SE Mcloughlin Boulevard @ SE 22nd Avenue	1	1	1	4540	0	10	1.00	0	100	No
5	SE 21st street @ SE Harrison Street	1	1	1	930	50	80	1.00	50	227	No
6	SE 32nd Avenue @ SE Johnson Creek Boulevard	1	1	1	1510	160	100	1.00	160	100	Yes



Oregon Department of Transportation

2012 - All SPIS Sites - By Hwy, MP

Region

1

Rte.	Rdwy	BMP	EMP	ADT	Crsh	Fatal	A	B	C	PDO City	County	Connection in Group	Percentile	SPIS	
081 PACIFIC HIGHWAY EAST															
OR-99E	1	4.41	4.50	42,300	14			1	6	7	MULTNOMAH		70	29.50	
OR-99E	1	4.42	4.51	42,300	13			1	6	6	MULTNOMAH		70	28.79	
OR-99E	1	4.43	4.52	42,300	11			1	6	4	MULTNOMAH		65	27.27	
OR-99E	1	4.44	4.53	42,300	11			1	6	4	MULTNOMAH	081BP CONN. (TACOMA)	65	27.27	
OR-99E	1	4.45	4.54	42,300	3				1	2	MULTNOMAH			9.66	
OR-99E	1	4.66	4.75	42,300	3			1		2	CLACKAMAS		70	27.66	
OR-99E	1	4.67	4.76	42,300	4			1	2	1	CLACKAMAS		70	29.19	
OR-99E	1	4.68	4.77	42,300	6			1	3	2	CLACKAMAS		80	33.16	
OR-99E	1	4.69	4.78	42,300	14			1	1	5	7	CLACKAMAS		90	44.50
OR-99E	1	4.70	4.79	42,300	14			1	1	4	8	CLACKAMAS		90	43.00
OR-99E	1	4.71	4.80	42,300	14			1	1	3	9	CLACKAMAS		85	41.50
OR-99E	1	4.72	4.81	42,300	14			1	1	3	9	CLACKAMAS		85	41.50
OR-99E	1	4.73	4.82	42,300	14			1	1	3	9	CLACKAMAS		85	41.50
OR-99E	1	4.74	4.83	42,300	15			1	1	3	10	CLACKAMAS		85	42.19
OR-99E	1	4.75	4.84	42,300	15			1	1	3	10	CLACKAMAS		85	42.19
OR-99E	1	4.76	4.85	42,300	14				1	3	10	CLACKAMAS		60	25.00
OR-99E	1	4.77	4.86	42,300	13				1	3	9	CLACKAMAS		60	24.29
OR-99E	1	4.78	4.87	42,300	11				1	2	8	CLACKAMAS	ACCESS (DECREASING R	50	21.27
OR-99E	1	4.78	4.87	42,300	11				1	2	8	CLACKAMAS	OCHOCO ST.	50	21.27
OR-99E	1	4.79	4.88	51,100	4					4		CLACKAMAS			9.52
OR-99E	1	4.80	4.89	51,100	3					3		CLACKAMAS			8.04
OR-99E	1	4.91	5.00	51,100	3				1	2		CLACKAMAS			9.54
OR-99E	1	4.92	5.01	51,100	3				1	2		CLACKAMAS			9.54
OR-99E	1	4.93	5.02	51,100	3				1	2		CLACKAMAS			9.54
OR-99E	1	4.94	5.03	51,100	3				1	2		CLACKAMAS			9.54
OR-99E	1	4.95	5.04	51,100	3				1	2		CLACKAMAS			9.54
OR-99E	1	4.96	5.05	51,100	3				1	2		CLACKAMAS			9.54
OR-99E	1	4.97	5.06	51,100	3				1	2		CLACKAMAS			9.54
OR-99E	1	4.98	5.07	51,100	3				1	2		CLACKAMAS			9.54
OR-99E	1	4.99	5.08	51,100	3				1	2		CLACKAMAS			9.54
OR-99E	1	5.08	5.17	51,100	3				1	2		CLACKAMAS		15	12.54
OR-99E	1	5.09	5.18	51,100	5				1	3	1	CLACKAMAS		35	16.79
OR-99E	1	5.10	5.19	51,100	7				1	5	1	CLACKAMAS		55	21.95
OR-99E	1	5.11	5.20	51,100	20	1			2	10	7	CLACKAMAS		95	56.67
OR-99E	1	5.12	5.21	51,100	20	1			2	10	7	CLACKAMAS		95	56.67
OR-99E	1	5.13	5.22	51,100	22	1			2	11	8	CLACKAMAS		95	59.28
OR-99E	1	5.14	5.23	51,100	23	1			2	12	8	CLACKAMAS		95	61.31
OR-99E	1	5.15	5.24	51,100	23	1			2	12	8	CLACKAMAS		95	61.31
OR-99E	1	5.16	5.25	51,100	23	1			2	12	8	CLACKAMAS		95	61.31
OR-99E	1	5.17	5.26	51,100	22	1			2	11	8	CLACKAMAS		95	59.28



Rte.	Rdwy	BMP	EMP	ADT	Crsh	Fatal	A	B	C	PDO	City	County	Connection in Group	Percentile	SPIS
081 PACIFIC HIGHWAY EAST															
OR-99E	1	5.18	5.27	51,100	21	1	2	10	8			CLACKAMAS		95	57.23
OR-99E	1	5.19	5.28	51,100	19	1	2	9	7			CLACKAMAS		95	54.61
OR-99E	1	5.20	5.29	51,100	17	1	2	7	7			CLACKAMAS	ACCESS (DECREASING R	90	50.42
OR-99E	1	5.20	5.29	51,100	17	1	2	7	7			CLACKAMAS	SE MILPORT RD.	90	50.42
OR-99E	1	5.21	5.30	39,200	3			2	1			CLACKAMAS		5	11.22
OR-99E	1	5.22	5.31	39,200	3			2	1			CLACKAMAS		5	11.22
OR-99E	1	5.62	5.71	25,100	4		1	2	1			CLACKAMAS		25	14.82
OR-99E	1	5.63	5.72	25,100	23		2	13	8			CLACKAMAS		90	49.48
OR-99E	1	5.64	5.73	25,100	25		3	13	9			CLACKAMAS		90	52.18
OR-99E	1	5.65	5.74	25,100	25		3	13	9			CLACKAMAS		90	52.18
OR-99E	1	5.66	5.75	25,100	25		3	13	9			CLACKAMAS		90	52.18
OR-99E	1	5.67	5.76	25,100	26		4	13	9			CLACKAMAS		95	54.25
OR-99E	1	5.68	5.77	25,100	27		4	13	10			CLACKAMAS		95	54.83
OR-99E	1	5.69	5.78	25,100	28		4	13	11			CLACKAMAS		95	55.40
OR-99E	1	5.70	5.79	25,100	28		4	13	11			CLACKAMAS		95	55.40
OR-99E	1	5.71	5.80	25,100	29		3	13	13			CLACKAMAS		95	54.44
OR-99E	1	5.72	5.81	32,500	27		3	11	13			CLACKAMAS	HWY. 081 M.P. (2)5.72	90	48.89
OR-99E	1	5.72	5.81	32,500	27		3	11	13			CLACKAMAS	17TH AVE.	90	48.89
OR-99E	1	5.73	5.82	32,500	8		2		6			CLACKAMAS		40	17.72
OR-99E	1	5.74	5.83	32,500	7		1		6			CLACKAMAS		30	15.19
OR-99E	1	5.75	5.84	32,500	7		1		6			CLACKAMAS		30	15.19
OR-99E	1	5.76	5.85	32,500	8		1		7			CLACKAMAS		35	16.22
OR-99E	1	5.77	5.86	32,500	7				7			CLACKAMAS	JACKSON ST.	20	13.69
OR-99E	1	5.78	5.87	32,500	5				5			CLACKAMAS		5	11.34
OR-99E	1	5.79	5.88	32,500	4				4			CLACKAMAS			9.97
OR-99E	1	5.80	5.89	32,500	4				4			CLACKAMAS			9.97
OR-99E	1	5.81	5.90	32,500	5			2	3			CLACKAMAS		25	14.34
OR-99E	1	5.82	5.91	32,500	6			2	4			CLACKAMAS		30	15.57
OR-99E	1	5.83	5.92	32,500	6			2	4			CLACKAMAS	SE MONROE ST.	30	15.57
OR-99E	1	5.84	5.93	32,500	9		1		4	4		CLACKAMAS		85	38.18
OR-99E	1	5.85	5.94	32,500	10		1	1	4	4		CLACKAMAS		85	40.60
OR-99E	1	5.86	5.95	32,500	9		1	1	4	3		CLACKAMAS		85	39.68
OR-99E	1	5.87	5.96	32,500	10		1	1	4	4		CLACKAMAS		85	40.60
OR-99E	1	5.88	5.97	32,500	11		1	1	4	5		CLACKAMAS	SE JEFFERSON ST.	85	41.45
OR-99E	1	5.88	5.97	32,500	11		1	1	4	5		CLACKAMAS	ROAD (BOAT LANDING)	85	41.45
OR-99E	1	5.89	5.98	32,500	11		1	1	4	5		CLACKAMAS		85	41.45
OR-99E	1	5.90	5.99	32,500	11		1	1	4	5		CLACKAMAS		85	41.45
OR-99E	1	5.91	6.00	32,500	9		1	1	3	4		CLACKAMAS		85	38.18
OR-99E	1	5.92	6.01	32,500	9		1	1	4	3		CLACKAMAS		85	39.68
OR-99E	1	5.93	6.02	32,500	9		1	1	4	3		CLACKAMAS	WASHINGTON ST.	85	39.68



Oregon Department of Transportation

2012 - All SPIS Sites - By Hwy, MP

Region

1

Rte.	Rdwy	BMP	EMP	ADT	Crsh	Fatal	A	B	C	PDO	City	County	Connection in Group	Percentile	SPIS
081 PACIFIC HIGHWAY EAST															
OR-99E	1	5.94	6.03	32,500	5		1	2	2			CLACKAMAS		30	15.84
OR-99E	1	5.95	6.04	32,500	4			2	2			CLACKAMAS		15	12.97
OR-99E	1	5.96	6.05	32,500	4			2	2			CLACKAMAS		15	12.97
OR-99E	1	5.97	6.06	32,500	3			2	1			CLACKAMAS		5	11.38
OR-99E	1	6.12	6.21	32,500	3			2	1			CLACKAMAS		5	11.38
OR-99E	1	6.13	6.22	32,500	3			2	1			CLACKAMAS		5	11.38
OR-99E	1	6.14	6.23	32,500	3			2	1			CLACKAMAS		5	11.38
OR-99E	1	6.15	6.24	32,500	3			2	1			CLACKAMAS		5	11.38
OR-99E	1	6.16	6.25	32,500	3			2	1			CLACKAMAS		5	11.38
OR-99E	1	6.17	6.26	32,500	3			2	1			CLACKAMAS		5	11.38
OR-99E	1	6.18	6.27	32,500	3			2	1			CLACKAMAS		5	11.38
OR-99E	1	6.21	6.30	32,500	4			3	1			CLACKAMAS	22ND AVE.	25	14.47
OR-99E	1	6.22	6.31	32,500	6			5	1			CLACKAMAS		45	20.07
OR-99E	1	6.23	6.32	32,500	7			6	1			CLACKAMAS		55	22.69
OR-99E	1	6.24	6.33	32,500	8			6	2			CLACKAMAS		60	23.72
OR-99E	1	6.25	6.34	32,500	8			6	2			CLACKAMAS		60	23.72
OR-99E	1	6.26	6.35	32,500	8			6	2			CLACKAMAS		60	23.72
OR-99E	1	6.27	6.36	32,500	8			6	2			CLACKAMAS		60	23.72
OR-99E	1	6.28	6.37	32,500	8			6	2			CLACKAMAS		60	23.72
OR-99E	1	6.29	6.38	32,500	8			6	2			CLACKAMAS		60	23.72
OR-99E	1	6.30	6.39	32,500	8			6	2			CLACKAMAS	BLUE BIRD ST.	60	23.72
OR-99E	1	6.30	6.39	32,500	8			6	2			CLACKAMAS	RIVER RD. (2ND RT.)	60	23.72
OR-99E	1	6.31	6.40	27,100	5			4	1			CLACKAMAS	LEG (FROM RIVER RD.)	40	17.63
OR-99E	1	6.45	6.54	27,100	3			2	1			CLACKAMAS		10	11.57
OR-99E	1	6.46	6.55	27,100	3			2	1			CLACKAMAS		10	11.57
OR-99E	1	6.66	6.75	27,100	3				3			CLACKAMAS			8.57
OR-99E	1	6.67	6.76	27,100	3				3			CLACKAMAS			8.57
OR-99E	1	6.68	6.77	27,100	3				3			CLACKAMAS			8.57
OR-99E	1	6.69	6.78	27,100	3				3			CLACKAMAS			8.57
OR-99E	1	6.70	6.79	27,100	3				3			CLACKAMAS			8.57
OR-99E	1	6.71	6.80	27,100	3				3			CLACKAMAS			8.57
OR-99E	1	6.72	6.81	27,100	5			2	3			CLACKAMAS		25	14.63
OR-99E	1	6.73	6.82	27,100	5			3	2			CLACKAMAS		35	16.13
OR-99E	1	6.74	6.83	27,100	5			3	2			CLACKAMAS		35	16.13
OR-99E	1	6.75	6.84	27,100	5			3	2			CLACKAMAS		35	16.13
OR-99E	1	6.76	6.85	27,100	5			4	1			CLACKAMAS		40	17.63
OR-99E	1	6.77	6.86	27,100	5			4	1			CLACKAMAS		40	17.63
OR-99E	1	6.78	6.87	27,100	10			7	3			CLACKAMAS		70	27.61
OR-99E	1	6.79	6.88	27,100	12			8	4			CLACKAMAS		75	30.86



Oregon Department of Transportation

2012 - All SPIS Sites - By Hwy, MP

Region

1

Rte.	Rdwy	BMP	EMP	ADT	Crsh	Fatal	A	B	C	PDO	City	County	Connection in Group	Percentile	SPIS
161 WOODBURN-ESTACADA															
OR-211	I	33.35	33.44	6,300	3				1	2		CLACKAMAS	S CADONAU RD.	15	13.25
OR-211	I	33.36	33.45	6,300	3				1	2		CLACKAMAS		15	13.25
OR-211	I	33.37	33.46	6,300	3				1	2		CLACKAMAS		15	13.25
OR-211	I	33.39	33.48	6,300	3					3		CLACKAMAS		10	11.75
OR-211	I	33.40	33.49	6,300	9			2	3	4		CLACKAMAS		75	30.51
171 CLACKAMAS															
	I	0.02	0.11	7,800	3					3		CLACKAMAS	LEG (FROM 17TH AVE.)	5	11.03
	I	0.03	0.12	7,800	3					3		CLACKAMAS		5	11.03
	I	0.04	0.13	7,800	3					3		CLACKAMAS		5	11.03
	I	0.05	0.14	7,800	5				1	4		CLACKAMAS		35	16.80
	I	0.06	0.15	7,800	5				1	4		CLACKAMAS		35	16.80
	I	0.07	0.16	7,800	5				1	4		CLACKAMAS		35	16.80
	I	0.08	0.17	7,800	5				1	4		CLACKAMAS		35	16.80
OR-224	I	0.09	0.18	7,800	5				1	4		CLACKAMAS		35	16.80
OR-224	I	0.10	0.19	7,800	4				1	3		CLACKAMAS		25	14.81
OR-224	I	0.11	0.20	7,800	3				1	2		CLACKAMAS		15	12.53
OR-224	I	0.58	0.67	24,800	3				1	2		CLACKAMAS			10.17
OR-224	I	0.59	0.68	24,800	25			5	10	10		CLACKAMAS		90	50.75
OR-224	I	0.60	0.69	24,800	26			5	11	10		CLACKAMAS		90	52.82
OR-224	I	0.61	0.70	24,800	26			5	11	10		CLACKAMAS		90	52.82
OR-224	I	0.62	0.71	24,800	26			5	11	10		CLACKAMAS		90	52.82
OR-224	I	0.63	0.72	24,800	26			5	11	10		CLACKAMAS		90	52.82
OR-224	I	0.64	0.73	24,800	26			5	11	10		CLACKAMAS		90	52.82
OR-224	I	0.65	0.74	24,800	26			5	11	10		CLACKAMAS		90	52.82
OR-224	I	0.66	0.75	24,800	26			5	11	10		CLACKAMAS		90	52.82
OR-224	I	0.67	0.76	24,800	26			5	11	10		CLACKAMAS		90	52.82
OR-224	I	0.68	0.77	24,800	24			6	10	8		CLACKAMAS	171AB CONN. (SE HARRI	90	51.65
OR-224	I	0.69	0.78	24,500	10			2	6	2		CLACKAMAS		70	29.43
OR-224	I	0.70	0.79	24,500	9			2	5	2		CLACKAMAS		65	26.95
OR-224	I	0.71	0.80	24,500	9			2	5	2		CLACKAMAS		65	26.95
OR-224	I	0.72	0.81	24,500	9			2	5	2		CLACKAMAS		65	26.95
OR-224	I	0.73	0.82	24,500	9			2	5	2		CLACKAMAS		65	26.95
OR-224	I	0.74	0.83	24,500	10			3	5	2		CLACKAMAS		70	29.43
OR-224	I	0.75	0.84	24,500	10			3	5	2		CLACKAMAS		70	29.43
OR-224	I	0.76	0.85	24,500	10			3	5	2		CLACKAMAS		70	29.43
OR-224	I	0.77	0.86	24,500	10			3	5	2		CLACKAMAS		70	29.43
OR-224	I	0.78	0.87	24,500	9			2	5	2		CLACKAMAS	171AC CONN. (SE MONROE	65	26.95
OR-224	I	0.82	0.91	25,100	3			1	1	1		CLACKAMAS		10	11.66
OR-224	I	0.83	0.92	25,100	6			1	3	2		CLACKAMAS		45	19.07
OR-224	I	0.84	0.93	25,100	19			2	5	12		CLACKAMAS		80	34.92



Rte.	Rdwy	BMP	EMP	ADT	Crsh	Fatal	A	B	C	PDO	City	County	Connection in Group	Percentile	SPIS
171 CLACKAMAS															
OR-224	I	0.85	0.94	25,100	20		2	5	13			CLACKAMAS		80	35.57
OR-224	I	0.86	0.95	25,100	21		2	5	14			CLACKAMAS		80	36.22
OR-224	I	0.87	0.96	25,100	21		2	5	14			CLACKAMAS		80	36.22
OR-224	I	0.88	0.97	25,100	21		2	5	14			CLACKAMAS		80	36.22
OR-224	I	0.89	0.98	25,100	21		2	4	15			CLACKAMAS		80	34.72
OR-224	I	0.90	0.99	25,100	21		2	4	15			CLACKAMAS		80	34.72
OR-224	I	0.91	1.00	25,100	21		2	4	15			CLACKAMAS		80	34.72
OR-224	I	0.92	1.01	25,100	21		2	4	15			CLACKAMAS		80	34.72
OR-224	I	0.93	1.02	25,100	18		2	2	14			CLACKAMAS	171AD CONN. (OAK ST.)	70	29.73
OR-224	I	0.94	1.03	25,700	4					4		CLACKAMAS			10.29
OR-224	I	0.95	1.04	25,700	3					3		CLACKAMAS			8.63
OR-224	I	1.23	1.32	25,700	8		2	2	4			CLACKAMAS		50	21.29
OR-224	I	1.24	1.33	25,700	8		2	2	4			CLACKAMAS		50	21.29
OR-224	I	1.25	1.34	25,700	8		2	2	4			CLACKAMAS		50	21.29
OR-224	I	1.26	1.35	25,700	8		2	2	4			CLACKAMAS		50	21.29
OR-224	I	1.27	1.36	25,700	8		2	2	4			CLACKAMAS		50	21.29
OR-224	I	1.28	1.37	25,700	8		2	2	4			CLACKAMAS	LEG (FROM 171AE CONN.	50	21.29
OR-224	I	1.29	1.38	25,700	8		2	2	4			CLACKAMAS		50	21.29
OR-224	I	1.30	1.39	25,700	8		2	2	4			CLACKAMAS		50	21.29
OR-224	I	1.31	1.40	25,700	7		2	2	3			CLACKAMAS		45	20.20
OR-224	I	1.32	1.41	25,700	7		2	2	3			CLACKAMAS	171AE CONN. (SE EDISON)	45	20.20
OR-224	I	1.80	1.89	25,700	8		2	3	3			CLACKAMAS		55	22.79
OR-224	I	1.81	1.90	25,700	8		2	3	3			CLACKAMAS		55	22.79
OR-224	I	1.82	1.91	25,700	8		2	3	3			CLACKAMAS		55	22.79
OR-224	I	1.83	1.92	25,700	8		2	3	3			CLACKAMAS		55	22.79
OR-224	I	1.84	1.93	25,700	8		2	3	3			CLACKAMAS		55	22.79
OR-224	I	1.85	1.94	25,700	8		2	3	3			CLACKAMAS		55	22.79
OR-224	I	1.86	1.95	25,700	8		2	3	3			CLACKAMAS		55	22.79
OR-224	I	1.87	1.96	25,700	8		2	3	3			CLACKAMAS		55	22.79
OR-224	I	1.88	1.97	25,700	8		2	3	3			CLACKAMAS		55	22.79
OR-224	I	1.89	1.98	25,700	7		2	3	2			CLACKAMAS	SE FREEMAN WAY	55	21.70
OR-224	I	2.63	2.72	27,300	6			4	2			CLACKAMAS		45	18.90
OR-224	I	2.64	2.73	27,300	7			4	3			CLACKAMAS		45	20.06
OR-224	I	2.65	2.74	27,300	7			4	3			CLACKAMAS		45	20.06
OR-224	I	2.66	2.75	27,300	8	1		4	3			CLACKAMAS		85	37.63
OR-224	I	2.67	2.76	27,300	8	1		4	3			CLACKAMAS		85	37.63
OR-224	I	2.68	2.77	27,300	9	1		4	4			CLACKAMAS		85	38.63
OR-224	I	2.69	2.78	27,300	10	1		4	5			CLACKAMAS	171AI CONN. M.P. 3C2.69	85	39.59
OR-224	I	2.70	2.79	26,900	9	1		4	4			CLACKAMAS		85	38.68
OR-224	I	2.71	2.80	26,900	9	1		4	4			CLACKAMAS		85	38.68



Rte.	Rdwy	BMP	EMP	ADT	Crsh	Fatal	A	B	C	PDO	City	County	Connection in Group	Percentile	SPIS
171 CLACKAMAS															
OR-224	I	2.72	2.81	26,900	9		1	4	4			CLACKAMAS	RUSK RD.	85	38.68
OR-224	I	2.73	2.82	26,900	5		1		4			CLACKAMAS		70	28.14
OR-224	I	2.74	2.83	26,900	4		1		3			CLACKAMAS		65	26.72
OR-224	I	2.75	2.84	26,900	4		1		3			CLACKAMAS		65	26.72
OR-224	I	2.76	2.85	26,900	3					3		CLACKAMAS			8.58
OR-224	I	2.77	2.86	26,900	3					3		CLACKAMAS			8.58
OR-224	I	3.06	3.15	26,900	3				3			CLACKAMAS		15	13.08
OR-224	I	3.07	3.16	26,900	4				3	1		CLACKAMAS		25	14.72
OR-224	I	3.08	3.17	26,900	4				3	1		CLACKAMAS		25	14.72
OR-224	I	3.09	3.18	26,900	4				3	1		CLACKAMAS		25	14.72
OR-224	I	3.10	3.19	26,900	9				6	3		CLACKAMAS		65	25.18
OR-224	I	3.11	3.20	26,900	25		1	2	9	13		CLACKAMAS		95	60.79
OR-224	I	3.12	3.21	26,900	31		2	2	10	17		CLACKAMAS		95	75.91
OR-224	I	3.13	3.22	26,900	32		2	2	11	17		CLACKAMAS		95	76.26
OR-224	I	3.14	3.23	26,900	34		2	2	12	18		CLACKAMAS		95	76.95
OR-224	I	3.15	3.24	26,900	34		2	2	12	18		CLACKAMAS		95	76.95
OR-224	I	3.16	3.25	26,900	33		2	2	11	18		CLACKAMAS		95	76.61
OR-224	I	3.17	3.26	26,900	32		2	2	11	17		CLACKAMAS		95	76.26
OR-224	I	3.18	3.27	26,900	32		2	2	11	17		CLACKAMAS		95	76.26
OR-224	I	3.19	3.28	26,900	32		2	2	11	17		CLACKAMAS		95	76.26
OR-224	I	3.20	3.29	26,900	28		2	2	9	15		CLACKAMAS	LAKE RD.	95	74.81
OR-224	I	3.21	3.30	29,200	11		1		5	5		CLACKAMAS		85	41.76
OR-224	I	3.22	3.31	29,200	5				4	1		CLACKAMAS		40	17.51
OR-224	I	3.23	3.32	29,200	6				4	2		CLACKAMAS		45	18.77
OR-224	I	3.24	3.33	29,200	9				7	2		CLACKAMAS		65	26.45
OR-224	I	3.25	3.34	29,200	9				7	2		CLACKAMAS		65	26.45
OR-224	I	3.26	3.35	29,200	10				7	3		CLACKAMAS		70	27.39
OR-224	I	3.27	3.36	29,200	10				7	3		CLACKAMAS		70	27.39
OR-224	I	3.28	3.37	29,200	10				7	3		CLACKAMAS		70	27.39
OR-224	I	3.29	3.38	29,200	10				7	3		CLACKAMAS		70	27.39
OR-224	I	3.30	3.39	29,200	8				5	3		CLACKAMAS		55	22.46
OR-224	I	3.31	3.40	29,200	8				5	3		CLACKAMAS		55	22.46
OR-224	I	3.32	3.41	29,200	8				5	3		CLACKAMAS		55	22.46
OR-224	I	3.33	3.42	29,200	6				4	2		CLACKAMAS	PHEASANT CT.	45	18.77
OR-224	I	3.60	3.69	35,100	4		1	1	2			CLACKAMAS		70	27.88
OR-224	I	3.61	3.70	35,100	6		1	2	3			CLACKAMAS		75	31.94
OR-224	I	3.62	3.71	35,100	10		1	1	3	5		CLACKAMAS		85	38.90
OR-224	I	3.63	3.72	35,100	10		1	1	3	5		CLACKAMAS		85	38.90
OR-224	I	3.64	3.73	35,100	30		2	3	12	13		CLACKAMAS		95	74.05
OR-224	I	3.65	3.74	35,100	32		2	3	13	14		CLACKAMAS		95	74.70
OR-224	I	3.66	3.75	35,100	37		2	4	15	16		CLACKAMAS		95	76.24

OREGON DEPARTMENT OF TRANSPORTATION - TRANSPORTATION DEVELOPMENT DIVISION
 TRANSPORTATION DATA SECTION - CRASH ANALYSIS AND REPORTING UNIT
 CRASH SUMMARIES BY YEAR BY COLLISION TYPE

All crashes in Milwaukie
 1-1-2003 through available 2006 2006 data could change

COLLISION TYPE	FATAL CRASHES	NON- FATAL CRASHES	PROPERTY DAMAGE ONLY	TOTAL CRASHES	PEOPLE KILLED	PEOPLE INJURED	TRUCKS	DRY SURF	WET SURF	DAY	DARK	INTER- SECTION	INTER- SECTION RELATED	OFF- ROAD
YEAR: 2006														
ANGLE	0	5	11	16	0	10	0	12	4	13	3	16	0	0
BACKING	0	1	1	2	0	1	0	2	0	2	0	0	0	0
FIXED / OTHER OBJECT	0	4	8	12	0	4	1	5	7	4	8	0	0	7
MISCELLANEOUS	0	1	0	1	0	1	0	0	0	1	0	0	0	0
PEDESTRIAN	0	1	0	1	0	1	0	0	1	1	0	1	0	0
REAR-END	0	12	18	30	0	18	0	20	10	22	8	4	5	0
SIDESWIPE - OVERTAKING	0	1	4	5	0	1	0	3	2	3	2	0	0	1
TURNING MOVEMENTS	0	11	17	28	0	17	2	20	8	23	5	17	0	2
2006 TOTAL	0	36	59	95	0	53	3	62	32	69	26	38	5	10
YEAR: 2005														
ANGLE	0	20	4	24	0	28	1	22	2	20	4	21	0	1
BACKING	0	0	4	4	0	0	0	2	2	3	1	0	0	1
FIXED / OTHER OBJECT	0	8	6	14	0	9	0	8	6	6	8	1	0	9
HEAD-ON	0	3	0	3	0	6	0	2	1	1	1	0	0	1
PEDESTRIAN	0	3	0	3	0	3	0	2	0	1	1	1	1	0
REAR-END	0	36	36	72	0	56	1	59	13	56	16	13	6	3
SIDESWIPE - MEETING	0	0	2	2	0	0	0	1	1	1	1	0	0	0
SIDESWIPE - OVERTAKING	0	3	2	5	0	5	0	4	1	3	2	0	0	0
TURNING MOVEMENTS	0	10	19	29	0	13	0	20	8	18	11	17	0	0
2005 TOTAL	0	83	73	156	0	120	2	120	34	109	45	53	7	15
YEAR: 2004														
ANGLE	0	11	13	24	0	18	0	22	2	20	4	21	0	0
BACKING	0	3	3	6	0	4	1	2	4	4	2	0	2	0
FIXED / OTHER OBJECT	0	4	9	13	0	4	0	9	4	6	7	2	1	10
HEAD-ON	0	1	1	2	0	1	0	1	1	1	1	0	0	0
MISCELLANEOUS	0	1	1	2	0	2	0	2	0	1	1	0	0	0
PEDESTRIAN	0	1	0	1	0	1	0	1	0	1	0	1	0	0
REAR-END	0	35	34	69	0	47	0	49	20	56	13	6	20	0
SIDESWIPE - MEETING	0	1	1	2	0	1	0	0	2	2	0	0	0	0
SIDESWIPE - OVERTAKING	0	2	4	6	0	2	0	6	0	6	0	0	1	0
TURNING MOVEMENTS	0	16	14	30	0	21	0	22	8	19	11	19	2	0
2004 TOTAL	0	75	80	155	0	101	1	114	41	116	39	49	26	10
YEAR: 2003														
ANGLE	0	18	25	43	0	29	0	34	9	38	5	32	1	1
BACKING	0	2	9	11	0	2	0	9	2	8	3	0	2	1
FIXED / OTHER OBJECT	0	6	8	14	0	7	0	10	4	5	9	1	0	14
HEAD-ON	0	1	1	2	0	2	0	2	0	2	0	0	0	1
NON-COLLISION	0	1	0	1	0	1	1	1	0	1	0	0	0	0
PARKING MOVEMENTS	0	0	1	1	0	0	0	1	0	1	0	0	0	1
PEDESTRIAN	0	3	0	3	0	3	0	1	2	0	3	1	2	0
REAR-END	0	35	34	69	0	48	4	42	26	60	9	26	12	0
SIDESWIPE - MEETING	0	0	2	2	0	0	0	2	0	1	1	0	0	0
SIDESWIPE - OVERTAKING	0	5	12	17	0	8	4	15	2	15	1	0	1	2
TURNING MOVEMENTS	0	10	18	28	0	13	2	19	9	24	4	19	0	1
2003 TOTAL	0	81	110	191	0	113	11	136	54	155	35	79	18	21

OREGON DEPARTMENT OF TRANSPORTATION - TRANSPORTATION DEVELOPMENT DIVISION
 TRANSPORTATION DATA SECTION - CRASH ANALYSIS AND REPORTING UNIT
 CRASH SUMMARIES BY YEAR BY COLLISION TYPE

All crashes in Milwaukie
 1-1-2003 through available 2006 2006 data could change

COLLISION TYPE	FATAL CRASHES	NON- FATAL CRASHES	PROPERTY DAMAGE ONLY	TOTAL CRASHES	PEOPLE KILLED	PEOPLE INJURED	TRUCKS	DRY SURF	WET SURF	DAY	DARK	INTER- SECTION	INTER- SECTION RELATED	OFF- ROAD
FINAL TOTAL	0	275	322	597	0	387	17	432	161	449	145	219	56	56

Note: Legislative changes to DMV's vehicle crash reporting requirements, effective 01/01/2004, may result in fewer property damage only crashes being eligible for inclusion in the Statewide Crash Data File.

OREGON DEPARTMENT OF TRANSPORTATION - TRANSPORTATION DEVELOPMENT DIVISION
 TRANSPORTATION DATA SECTION - CRASH ANALYSIS AND REPORTING UNIT
 CRASH SUMMARIES BY YEAR BY COLLISION TYPE

McLoughlin Blvd (Route 99E, Hwy 81 at SE Ochoco Street in Milwaukie
 1-1-2003 through 12-31-2005

COLLISION TYPE	FATAL CRASHES	NON- FATAL CRASHES	PROPERTY DAMAGE ONLY	TOTAL CRASHES	PEOPLE KILLED	PEOPLE INJURED	TRUCKS	DRY SURF	WET SURF	DAY	DARK	INTER- SECTION	INTER- SECTION RELATED	OFF- ROAD
YEAR: 2005														
ANGLE	0	0	1	1	0	0	1	1	0	1	0	1	0	0
TURNING MOVEMENTS	0	1	0	1	0	1	0	1	0	1	0	1	0	0
2005 TOTAL	0	1	1	2	0	1	1	2	0	2	0	2	0	0
YEAR: 2004														
ANGLE	0	1	0	1	0	3	0	1	0	1	0	1	0	0
2004 TOTAL	0	1	0	1	0	3	0	1	0	1	0	1	0	0
YEAR: 2003														
REAR-END	0	2	0	2	0	4	0	1	1	2	0	2	0	0
2003 TOTAL	0	2	0	2	0	4	0	1	1	2	0	2	0	0
FINAL TOTAL	0	4	1	5	0	8	1	4	1	5	0	5	0	0

Note: Legislative changes to DMV's vehicle crash reporting requirements, effective 01/01/2004, may result in fewer property damage only crashes being eligible for inclusion in the Statewide Crash Data File.

OREGON DEPARTMENT OF TRANSPORTATION - TRANSPORTATION DEVELOPMENT DIVISION
 TRANSPORTATION DATA SECTION - CRASH ANALYSIS AND REPORTING UNIT
 CRASH SUMMARIES BY YEAR BY COLLISION TYPE

McLoughlin Blvd (Route 99E, Hwy 81) at SE Milport Road in Milwaukie
 1-1-2003 through 12-31-2005

COLLISION TYPE	FATAL CRASHES	NON- FATAL CRASHES	PROPERTY DAMAGE ONLY	TOTAL CRASHES	PEOPLE KILLED	PEOPLE INJURED	TRUCKS	DRY SURF	WET SURF	DAY	DARK	INTER- SECTION	INTER- SECTION RELATED	OFF- ROAD
YEAR: 2004														
ANGLE	0	2	1	3	0	5	0	3	0	2	1	3	0	0
2004 TOTAL	0	2	1	3	0	5	0	3	0	2	1	3	0	0
YEAR: 2003														
ANGLE	0	1	1	2	0	3	0	1	1	1	1	2	0	0
REAR-END	0	1	1	2	0	1	0	0	1	2	0	2	0	0
TURNING MOVEMENTS	0	0	2	2	0	0	1	2	0	1	1	2	0	0
2003 TOTAL	0	2	4	6	0	4	1	3	2	4	2	6	0	0
FINAL TOTAL	0	4	5	9	0	9	1	6	2	6	3	9	0	0

Note: Legislative changes to DMV's vehicle crash reporting requirements, effective 01/01/2004, may result in fewer property damage only crashes being eligible for inclusion in the Statewide Crash Data File.

OREGON DEPARTMENT OF TRANSPORTATION - TRANSPORTATION DEVELOPMENT DIVISION
 TRANSPORTATION DATA SECTION - CRASH ANALYSIS AND REPORTING UNIT
 CRASH SUMMARIES BY YEAR BY COLLISION TYPE

McLoughlin Blvd (Route 99E, Hwy 81) at SE Monroe Street in Milwaukie
 1-1-2003 through 12-31-2005

COLLISION TYPE	FATAL CRASHES	NON- FATAL CRASHES	PROPERTY DAMAGE ONLY	TOTAL CRASHES	PEOPLE KILLED	PEOPLE INJURED	TRUCKS	DRY SURF	WET SURF	DAY	DARK	INTER- SECTION	INTER- SECTION RELATED	OFF- ROAD
----------------	------------------	--------------------------	----------------------------	------------------	------------------	-------------------	--------	-------------	-------------	-----	------	-------------------	------------------------------	--------------

YEAR:

TOTAL

FINAL TOTAL

Note: Legislative changes to DMV's vehicle crash reporting requirements, effective 01/01/2004, may result in fewer property damage only crashes being eligible for inclusion in the Statewide Crash Data File.

OREGON DEPARTMENT OF TRANSPORTATION - TRANSPORTATION DEVELOPMENT DIVISION
 TRANSPORTATION DATA SECTION - CRASH ANALYSIS AND REPORTING UNIT
 CRASH SUMMARIES BY YEAR BY COLLISION TYPE

McLoughlin Blvd (Route 99E, Hwy 81) at SE Washington Street in Milwaukie
 1-1-2003 through 12-31-2005

COLLISION TYPE	FATAL CRASHES	NON- FATAL CRASHES	PROPERTY DAMAGE ONLY	TOTAL CRASHES	PEOPLE KILLED	PEOPLE INJURED	TRUCKS	DRY SURF	WET SURF	DAY	DARK	INTER- SECTION	INTER- SECTION RELATED	OFF- ROAD
YEAR: 2005														
FIXED / OTHER OBJECT	0	0	1	1	0	0	0	1	0	1	0	1	0	1
2005 TOTAL	0	0	1	1	0	0	0	1	0	1	0	1	0	1
YEAR: 2003														
REAR-END	0	1	0	1	0	1	0	0	1	1	0	1	0	0
2003 TOTAL	0	1	0	1	0	1	0	0	1	1	0	1	0	0
FINAL TOTAL	0	1	1	2	0	1	0	1	1	2	0	2	0	1

Note: Legislative changes to DMV's vehicle crash reporting requirements, effective 01/01/2004, may result in fewer property damage only crashes being eligible for inclusion in the Statewide Crash Data File.

OREGON DEPARTMENT OF TRANSPORTATION - TRANSPORTATION DEVELOPMENT DIVISION
 TRANSPORTATION DATA SECTION - CRASH ANALYSIS AND REPORTING UNIT
 CRASH SUMMARIES BY YEAR BY COLLISION TYPE

McLoughlin Blvd (Route 99E, Hwy 81) at SE River Road in Milwaukie
 1-1-2003 through 12-31-2005

COLLISION TYPE	FATAL CRASHES	NON- FATAL CRASHES	PROPERTY DAMAGE ONLY	TOTAL CRASHES	PEOPLE KILLED	PEOPLE INJURED	TRUCKS	DRY SURF	WET SURF	DAY	DARK	INTER- SECTION	INTER- SECTION RELATED	OFF- ROAD
YEAR: 2005														
REAR-END	0	0	2	2	0	0	0	0	2	2	0	2	0	0
2005 TOTAL	0	0	2	2	0	0	0	0	2	2	0	2	0	0
YEAR: 2004														
ANGLE	0	0	1	1	0	0	0	1	0	0	1	1	0	0
FIXED / OTHER OBJECT	0	0	1	1	0	0	0	1	0	1	0	1	0	1
REAR-END	0	0	1	1	0	0	0	1	0	1	0	1	0	0
2004 TOTAL	0	0	3	3	0	0	0	3	0	2	1	3	0	1
FINAL TOTAL	0	0	5	5	0	0	0	3	2	4	1	5	0	1

Note: Legislative changes to DMV's vehicle crash reporting requirements, effective 01/01/2004, may result in fewer property damage only crashes being eligible for inclusion in the Statewide Crash Data File.

OREGON DEPARTMENT OF TRANSPORTATION - TRANSPORTATION DEVELOPMENT DIVISION
 TRANSPORTATION DATA SECTION - CRASH ANALYSIS AND REPORTING UNIT
 CRASH SUMMARIES BY YEAR BY COLLISION TYPE

Clackamas Hwy (Route 224, Hwy 171) at SE 17th Avenue in Milwaukie
 1-1-2003 through 12-31-2005

COLLISION TYPE	FATAL CRASHES	NON- FATAL CRASHES	PROPERTY DAMAGE ONLY	TOTAL CRASHES	PEOPLE KILLED	PEOPLE INJURED	TRUCKS	DRY SURF	WET SURF	DAY	DARK	INTER- SECTION	INTER- SECTION RELATED	OFF- ROAD
YEAR: 2004														
REAR-END	0	1	0	1	0	3	0	1	0	1	0	1	0	0
2004 TOTAL	0	1	0	1	0	3	0	1	0	1	0	1	0	0
YEAR: 2003														
REAR-END	0	0	1	1	0	0	0	1	0	1	0	1	0	0
2003 TOTAL	0	0	1	1	0	0	0	1	0	1	0	1	0	0
FINAL TOTAL	0	1	1	2	0	3	0	2	0	2	0	2	0	0

Note: Legislative changes to DMV's vehicle crash reporting requirements, effective 01/01/2004, may result in fewer property damage only crashes being eligible for inclusion in the Statewide Crash Data File.

OREGON DEPARTMENT OF TRANSPORTATION - TRANSPORTATION DEVELOPMENT DIVISION
 TRANSPORTATION DATA SECTION - CRASH ANALYSIS AND REPORTING UNIT
 CRASH SUMMARIES BY YEAR BY COLLISION TYPE

Clackamas Hwy (Route 224, Hwy 171) at SE Harrison Street in Milwaukie
 1-1-2003 through 12-31-2005

COLLISION TYPE	FATAL CRASHES	NON- FATAL CRASHES	PROPERTY DAMAGE ONLY	TOTAL CRASHES	PEOPLE KILLED	PEOPLE INJURED	TRUCKS	DRY SURF	WET SURF	DAY	DARK	INTER- SECTION	INTER- SECTION RELATED	OFF- ROAD
YEAR: 2005														
ANGLE	0	0	1	1	0	0	0	0	1	0	1	1	0	0
REAR-END	0	0	1	1	0	0	0	0	1	0	1	1	0	0
TURNING MOVEMENTS	0	3	1	4	0	4	0	4	0	2	2	4	0	0
2005 TOTAL	0	3	3	6	0	4	0	4	2	2	4	6	0	0
YEAR: 2003														
ANGLE	0	1	0	1	0	1	0	1	0	1	0	1	0	0
REAR-END	0	0	2	2	0	0	0	2	0	2	0	2	0	0
TURNING MOVEMENTS	0	0	1	1	0	0	0	0	1	0	1	1	0	0
2003 TOTAL	0	1	3	4	0	1	0	3	1	3	1	4	0	0
FINAL TOTAL	0	4	6	10	0	5	0	7	3	5	5	10	0	0

Note: Legislative changes to DMV's vehicle crash reporting requirements, effective 01/01/2004, may result in fewer property damage only crashes being eligible for inclusion in the Statewide Crash Data File.

OREGON DEPARTMENT OF TRANSPORTATION - TRANSPORTATION DEVELOPMENT DIVISION
 TRANSPORTATION DATA SECTION - CRASH ANALYSIS AND REPORTING UNIT
 CRASH SUMMARIES BY YEAR BY COLLISION TYPE

Clackamas Hwy (Route 224, Hwy 171) at SE Monroe Street in Milwaukie
 1-1-2003 through 12-31-2005

COLLISION TYPE	FATAL CRASHES	NON- FATAL CRASHES	PROPERTY DAMAGE ONLY	TOTAL CRASHES	PEOPLE KILLED	PEOPLE INJURED	TRUCKS	DRY SURF	WET SURF	DAY	DARK	INTER- SECTION	INTER- SECTION RELATED	OFF- ROAD
YEAR: 2005														
ANGLE	0	2	0	2	0	3	0	2	0	2	0	2	0	0
TURNING MOVEMENTS	0	0	1	1	0	0	0	1	0	0	1	1	0	0
2005 TOTAL	0	2	1	3	0	3	0	3	0	2	1	3	0	0
YEAR: 2003														
REAR-END	0	0	1	1	0	0	0	0	1	1	0	1	0	0
TURNING MOVEMENTS	0	0	1	1	0	0	0	1	0	1	0	1	0	0
2003 TOTAL	0	0	2	2	0	0	0	1	1	2	0	2	0	0
FINAL TOTAL	0	2	3	5	0	3	0	4	1	4	1	5	0	0

Note: Legislative changes to DMV's vehicle crash reporting requirements, effective 01/01/2004, may result in fewer property damage only crashes being eligible for inclusion in the Statewide Crash Data File.

OREGON DEPARTMENT OF TRANSPORTATION - TRANSPORTATION DEVELOPMENT DIVISION
 TRANSPORTATION DATA SECTION - CRASH ANALYSIS AND REPORTING UNIT
 CRASH SUMMARIES BY YEAR BY COLLISION TYPE

Clackamas Hwy (Route 224, Hwy 171) at SE 37th Avenue and SE Edison Street in Milwaukie
 1-1-2003 through 12-31-2005

COLLISION TYPE	FATAL CRASHES	NON- FATAL CRASHES	PROPERTY DAMAGE ONLY	TOTAL CRASHES	PEOPLE KILLED	PEOPLE INJURED	TRUCKS	DRY SURF	WET SURF	DAY	DARK	INTER- SECTION	INTER- SECTION RELATED	OFF- ROAD
YEAR: 2004														
ANGLE	0	1	0	1	0	2	0	1	0	1	0	1	0	0
2004 TOTAL	0	1	0	1	0	2	0	1	0	1	0	1	0	0
FINAL TOTAL	0	1	0	1	0	2	0	1	0	1	0	1	0	0

Note: Legislative changes to DMV's vehicle crash reporting requirements, effective 01/01/2004, may result in fewer property damage only crashes being eligible for inclusion in the Statewide Crash Data File.

OREGON DEPARTMENT OF TRANSPORTATION - TRANSPORTATION DEVELOPMENT DIVISION
 TRANSPORTATION DATA SECTION - CRASH ANALYSIS AND REPORTING UNIT
 CRASH SUMMARIES BY YEAR BY COLLISION TYPE

Clackamas Hwy (Route 224, Hwy 171) at SE Freeman Way in Milwaukie
 1-1-2003 through 12-31-2005

COLLISION TYPE	FATAL CRASHES	NON- FATAL CRASHES	PROPERTY DAMAGE ONLY	TOTAL CRASHES	PEOPLE KILLED	PEOPLE INJURED	TRUCKS	DRY SURF	WET SURF	DAY	DARK	INTER- SECTION	INTER- SECTION RELATED	OFF- ROAD
YEAR: 2005														
REAR-END	0	1	0	1	0	2	0	1	0	1	0	1	0	0
2005 TOTAL	0	1	0	1	0	2	0	1	0	1	0	1	0	0
YEAR: 2003														
REAR-END	0	2	1	3	0	3	2	2	1	3	0	3	0	0
2003 TOTAL	0	2	1	3	0	3	2	2	1	3	0	3	0	0
FINAL TOTAL	0	3	1	4	0	5	2	3	1	4	0	4	0	0

Note: Legislative changes to DMV's vehicle crash reporting requirements, effective 01/01/2004, may result in fewer property damage only crashes being eligible for inclusion in the Statewide Crash Data File.

OREGON DEPARTMENT OF TRANSPORTATION - TRANSPORTATION DEVELOPMENT DIVISION
 TRANSPORTATION DATA SECTION - CRASH ANALYSIS AND REPORTING UNIT
 CRASH SUMMARIES BY YEAR BY COLLISION TYPE

Clackamas Hwy (Route 224, Hwy 171) at SE Harmony Road in/near Milwaukie
 1-1-2003 through 12-31-2005

COLLISION TYPE	FATAL CRASHES	NON- FATAL CRASHES	PROPERTY DAMAGE ONLY	TOTAL CRASHES	PEOPLE KILLED	PEOPLE INJURED	TRUCKS	DRY SURF	WET SURF	DAY	DARK	INTER- SECTION	INTER- SECTION RELATED	OFF- ROAD
YEAR: 2005														
TURNING MOVEMENTS	0	0	1	1	0	0	1	1	0	1	0	1	0	0
2005 TOTAL	0	0	1	1	0	0	1	1	0	1	0	1	0	0
FINAL TOTAL	0	0	1	1	0	0	1	1	0	1	0	1	0	0

Note: Legislative changes to DMV's vehicle crash reporting requirements, effective 01/01/2004, may result in fewer property damage only crashes being eligible for inclusion in the Statewide Crash Data File.

OREGON DEPARTMENT OF TRANSPORTATION - TRANSPORTATION DEVELOPMENT DIVISION
 TRANSPORTATION DATA SECTION - CRASH ANALYSIS AND REPORTING UNIT
 CRASH SUMMARIES BY YEAR BY COLLISION TYPE

Clackamas Hwy (Route 224, Hwy 171) at SE Lake Road in/near Milwaukie
 1-1-2003 through 12-31-2005

COLLISION TYPE	FATAL CRASHES	NON- FATAL CRASHES	PROPERTY DAMAGE ONLY	TOTAL CRASHES	PEOPLE KILLED	PEOPLE INJURED	TRUCKS	DRY SURF	WET SURF	DAY	DARK	INTER- SECTION	INTER- SECTION RELATED	OFF- ROAD
YEAR: 2005														
ANGLE	0	1	0	1	0	1	0	0	1	1	0	1	0	0
REAR-END	0	1	1	2	0	3	0	2	0	1	1	2	0	0
TURNING MOVEMENTS	1	0	2	3	1	1	0	3	0	1	2	3	0	0
2005 TOTAL	1	2	3	6	1	5	0	5	1	3	3	6	0	0
YEAR: 2004														
ANGLE	0	1	1	2	0	3	0	2	0	2	0	2	0	0
2004 TOTAL	0	1	1	2	0	3	0	2	0	2	0	2	0	0
YEAR: 2003														
ANGLE	0	3	0	3	0	4	0	2	1	2	1	3	0	0
REAR-END	0	1	3	4	0	3	0	3	1	3	1	4	0	0
2003 TOTAL	0	4	3	7	0	7	0	5	2	5	2	7	0	0
FINAL TOTAL	1	7	7	15	1	15	0	12	3	10	5	15	0	0

Note: Legislative changes to DMV's vehicle crash reporting requirements, effective 01/01/2004, may result in fewer property damage only crashes being eligible for inclusion in the Statewide Crash Data File.

Pedestrian Master Plan

DRAFT CONCEPT PLAN (JULY 2007)

Contingency (construction, design, admin)

Bridge Cost/SF

ROW Cost/SF staff+appraisals

75%

\$275

\$17

22%

Total Length [ft]	Number of Bridges	Total Bridge Length (ft)	Net Road Length	Name	Improvement	From	To	Functional Classification	Lanes	Cost/LF	Road Cost	w/ Contingency	Bridge Width (ft)	Bridge Cost	w/ Contingency	ROW Width (ft)	ROW Cost	w/ staff costs & appraisals	Cost			
4380			4380	SE 17 th Avenue	Fill in sidewalk gaps on both sides of street.	SE Ochoco Street	SE McLoughlin Boulevard	Arterial		\$120	\$525,600	\$919,800				0	\$0	\$0	\$919,800			
4910			4910	SE Lake Road	Fill in sidewalk gaps on both sides of street.	SE Oatfield Road	Hwy 224	Arterial		\$120	\$589,200	\$1,031,100				10	\$834,700	\$1,018,334	\$2,049,434			
5200			5200	SE Monroe Street	Fill in sidewalk gaps on both sides of street.	SE 42nd Avenue	City limit	Collector		\$120	\$624,000	\$1,092,000				5	\$442,000	\$539,240	\$1,631,240			
8260			8260	SE Stanley Avenue	Fill in sidewalk gaps on both sides of street.	SE Johnson Creek Boulevard	SE Railroad Avenue	Collector		\$120	\$991,200	\$1,734,600				15	\$2,106,300	\$2,569,686	\$4,304,286			
7740			7740	SE Railroad Avenue	Fill in sidewalk gaps on both sides of street.	SE 37th Avenue	SE Harmony Road	Collector		\$120	\$928,800	\$1,625,400							\$1,625,400			
				Sidewalk maintenance	Clear overhanging vegetation and other obstructions from sidewalks; Repair of safety hazards on existing sidewalks	Citywide	Citywide												\$20,000			
				SE 43 rd Avenue/SE King Road	Intersection enhancements	Location specific	Location specific			N/A	\$10,000						\$0	\$0	\$15,000			
3660			3660	SE Brookside Drive	Fill in sidewalk gaps on both sides of street.	SE Johnson Creek Boulevard	SE Regents Drive	Local Street		\$120	\$439,200	\$768,600					\$0	\$0	\$15,000			
2840			2840	SE McLoughlin Boulevard	Fill in sidewalk gaps on both sides of street.	SE Washington Street	City limits	Regional Route		\$120	\$340,800	\$596,400				0	\$0	\$0	\$596,400			
				SE Railroad Avenue/SE Oak Street	Intersection enhancements	Location specific	Location specific												\$15,000			
				Identify walkways	Provide maps and signage on streets to identify ways to get through the city	Citywide	Citywide												\$10,000			
				Pedestrian Amenities along routes	Install amenities, such as benches, and similar improvements along key walking routes	Citywide	Citywide												\$50,000			
				Policy to develop walkways on essential routes	Focus on construct sidewalk or appropriate walkways on important pedestrian routes	Citywide	Citywide												\$0			
				Police enforcement on automobiles	Enforcement of speeding violations, including photo radar, to make the streets generally safer; Enforcement of laws related to pedestrian crossings and crosswalks	Citywide	Citywide												\$0			
				Pedestrian safety at schools	Utilize safe routes to schools programs and resources	Citywide	Citywide												\$0			
				Policies that encourage walking	Support mixed-use development and services near residential areas; Re-examine automobile centered policies, such as high amounts of required parking	Citywide	Citywide												\$0			
1450			1450	SE 19th Avenue	Fill in sidewalk gaps on both sides of street.	SE Eagle Street	SE Sparrow Street	Arterial		\$120	\$174,000	\$304,500				0	\$0	\$0	\$304,500			
1550			1550	SE 22nd Avenue	Fill in sidewalk gaps on both sides of street.	Hwy 99E	SE Sparrow Street	Arterial		\$120	\$186,000	\$325,500				0	\$0	\$0	\$325,500			
3780			3780	SE 37th Avenue	Fill in sidewalk gaps on both sides of street.	SE Lake Road	SE Harrison Street	Collector		\$120	\$453,600	\$793,800				0	\$0	\$0	\$793,800			
2620			2620	SE 43rd Avenue	Fill in sidewalk gaps on both sides of street.	SE Olsen Street	SE King Road	Collector		\$120	\$314,400	\$550,200				0	\$0	\$0	\$550,200			
550			550	SE Edison Street	Fill in sidewalk gaps on both sides of street.	SE 35th Avenue	SE 37th Avenue	Local Street		\$120	\$66,000	\$115,500				0	\$0	\$0	\$115,500			
180			180	SE Harmony Road	Fill in sidewalk gaps on both sides of street.	SE Linwood Avenue	City limits	Arterial		\$120	\$21,600	\$37,800				0	\$0	\$0	\$37,800			
1280			1280	SE Harvey Street	Fill in sidewalk gaps on both sides of street.	SE 32nd Avenue	SE 42nd Avenue	Neighborhood Route		\$120	\$153,600	\$268,800				10	\$217,600	\$265,472	\$534,272			
3600			3600	SE Home Avenue	Fill in sidewalk gaps on both sides of street.	SE Railroad Avenue	SE King Road	Neighborhood Route		\$120	\$432,000	\$756,000				0	\$0	\$0	\$756,000			
3650			3650	SE International Way	Fill in sidewalk gaps on both sides of street.	SE Freeman Way	SE Lake Road	Local Street		\$120	\$438,000	\$766,500				0	\$0	\$0	\$766,500			
1800			1800	SE Johnson Creek Boulevard	Fill in sidewalk gaps on both sides of street.	SE Harney Drive	City limits	Arterial		\$120	\$216,000	\$378,000				0	\$0	\$0	\$378,000			
6450			6450	SE Linwood Avenue	Fill in sidewalk gaps on both sides of street.	SE Johnson Creek Boulevard	SE Railroad Avenue	Arterial		\$120	\$774,000	\$1,354,500				12	\$1,315,800	\$1,605,276	\$2,959,776			
3360			3360	SE Logus Road	Fill in sidewalk gaps on both sides of street.	SE 43rd Avenue	SE Stanley Road	Neighborhood Route		\$120	\$403,200	\$705,600				8	\$456,960	\$557,491	\$1,263,091			
2140			2140	SE Mason Lane	Fill in sidewalk gaps on both sides of street.	SE 42nd Avenue	SE Regents Drive	Neighborhood Route		\$120	\$256,800	\$449,400				5	\$181,900	\$221,918	\$671,318			
630			630	SE Oatfield Road	Fill in sidewalk gaps on both sides of street.	SE Guilford Court	City Limits	Arterial		\$120	\$75,600	\$132,300				0	\$0	\$0	\$132,300			
2350			2350	SE Regents Drive	Fill in sidewalk gaps on both sides of street.	SE Brookside Drive	SE Winsor Drive	Neighborhood Route		\$120	\$282,000	\$493,500				0	\$0	\$0	\$493,500			
1500			1500	SE River Road	Fill in sidewalk gaps on both sides of street.	Hwy 99E	SE Lark Street	Arterial		\$120	\$180,000	\$315,000				10	\$255,000	\$311,100	\$626,100			
460			460	SE Roswell Street	Fill in sidewalk gaps on both sides of street.	SE 32nd Avenue	SE 36th Avenue	Neighborhood Route		\$120	\$55,200	\$96,600				10	\$78,200	\$95,404	\$192,004			
2110			2110	SE Rusk Road	Fill in sidewalk gaps on both sides of street.	SE Lake Road	North Clackamas Park	Collector		\$120	\$253,200	\$443,100				5	\$179,350	\$218,807	\$661,907			
1035			1035	SE Olsen Street	Fill in sidewalk gaps on north side of street.	SE 32nd Avenue	SE 43rd Avenue	Neighborhood Route		\$120	\$124,200	\$217,350				10	\$175,950	\$214,659	\$432,009			
				Intersections throughout the City	Install curb ramps at all intersections with sidewalks*	Citywide	Citywide			N/A	\$5,000	5,000 per ramp					\$0	\$0	\$5,000			
				SE 37th Avenue/Hwy 224	Intersection enhancements	Location specific	Location specific			N/A	\$20,000						\$0	\$0	\$20,000			
				SE Freeman Way/Hwy 224	Intersection enhancements	Location specific	Location specific			N/A	\$20,000						\$0	\$0	\$20,000			
				SE Harmony Road/SE Lake Road	Intersection enhancements	Location specific	Location specific			N/A	\$20,000						\$0	\$0	\$15,000			
				SE Harrison Street/Hwy 224	Intersection enhancements	Location specific	Location specific			N/A	\$20,000						\$0	\$0	\$20,000			
				SE Monroe Street/Hwy 224	Intersection enhancements	Location specific	Location specific			N/A	\$20,000						\$0	\$0	\$15,000			
2000			2000	Hwy 224	Fill in sidewalk gaps on both sides of street.	SE Oak Street	SE 37th Avenue	Regional Route		\$120	\$240,000	\$420,000				0	\$0	\$0	\$420,000			
				SE Oak Street/Hwy 224	Intersection enhancements	Location specific	Location specific			N/A	\$20,000						\$0	\$0	\$20,000			
				SE Olsen Street/SE 42nd Avenue	Intersection enhancements	Location specific	Location specific			N/A	\$10,000						\$0	\$0	\$20,000			
				SE Railroad Avenue/SE 37 th Avenue	Intersection enhancements	Location specific	Location specific			N/A	\$10,000						\$0	\$0	\$10,000			
3840			3840	North Clackamas Park	Provide sidewalks to connect park to school.	North Clackamas Park	Rowe Middle School	Arterial		\$120	\$460,800	\$806,400				6	\$391,680	\$477,850	\$1,284,250			
				SE Stanley Avenue/SE Logus Road	Intersection enhancements	Location specific	Location specific												\$15,000			
				Improved Ramp at Springwater Trail/SE McLoughlin Boulevard	Intersection enhancements	Location specific	Location specific												\$15,000			
				SE 49th Avenue	Fill in sidewalk gaps on both sides of street.	SE Logus Road	SE King Road	Neighborhood Route											\$250,000			
				Policy to develop walkways throughout the City	Construct sidewalks or appropriate walkways everywhere as development occurs or capital funds become available.	Citywide	Citywide												\$10,000			
				Police enforcement on pedestrians	Enforce laws related to pedestrians and street crossings	Citywide	Citywide												\$10,000			
				Improved Education	Educate general public about pedestrian safety; Inform general public about traffic laws related to pedestrians	Citywide	Citywide												\$10,000			
subtotal											\$10,154,000	\$17,498,250	\$0	\$0	\$6,635,440	\$8,095,237						
construction subtotal														\$10,154,000								
contingency														\$7,615,500								
Total																			\$25,404,887			

Bike Master Plan

Contingency (construction, design, admin)

Bridge Cost/SF

ROW Cost/SF staff+appraisals

DRAFT CONCEPT PLAN (JULY 2007)

75%

\$275

\$17

22%

Total Length [ft]	Number of Bridges	Total Bridge Length (ft)	Net Road Length	Name	Improvement	From	To	Functional Classification	Lanes		Cost/LF	Road Cost	w/ Contingency	Bridge Width (ft)	Bridge Cost	w/ Contingency	ROW Width (ft)	ROW Cost	w/ staff costs & appraisals	Cost	
		0		Citywide	Signage for neighborhood bike routes	Citywide	Citywide			TSP	N/A									\$150,000	
		0		Citywide	Sweeping of bike lanes to remove debris	Citywide	Citywide			TSP	N/A									\$50,000	
		0		Citywide	Education for bike use and route selection	Citywide	Citywide			TSP	N/A									\$10,000	
		0		SE 17th Avenue/Hwy 99E	Improve safety of crossing at intersection and connection westbound on SE 17th Avenue.	Location specific	Location specific			TSP	N/A									\$10,000	
		0		SE 17th Avenue/Hwy 224	Improve safety of crossing at intersection.	Location specific	Location specific			TSP	N/A									\$10,000	
		0		SE Washington Street/SE Oak Street/Hwy 224	Improve safety of crossing at intersection.	Location specific	Location specific			TSP	N/A									\$10,000	
		0		Citywide	Coordination of community rides to encourage bike use.	Citywide	Citywide			TSP	N/A									\$5,000	
2340		2340		SE 19th Avenue and SE Sparrow Street	Enhance corridor for bicycle travel. This would connect the south end of Kellogg Creek Trail to SE River Road	SE Eagle Street	SE River Road	Local		TSP	\$180	\$421,200	\$737,100				0	\$0	\$0	\$737,100	
1310		1310		SE 17th Avenue	Fill in gaps in existing bicycle network with bike lanes.	SE Waverly Drive	SE Harrison Street	Arterial		TSP	\$50	\$65,500	\$114,625				0	\$0	\$0	\$114,625	
		0		Citywide	Multi-jurisdictional coordination	Citywide	Citywide			TSP	N/A									\$10,000	
		0		SE Johnson Creek Boulevard/Springwater Corridor	Improve safety of crossing at intersection.	Location specific	Location specific			TSP	N/A									\$10,000	
520		520		SE Harrison Street	Fill in gaps in existing bicycle network with bike lanes.	Hwy 99E	SE 21st Avenue	Arterial		TSP	\$300	\$156,000	\$273,000				0	\$0	\$0	\$273,000	
16510	0	0	16510	Springwater Corridor	Improve corridor through repaving	"Three Bridges" area	SE 82nd Avenue	Trail		TSP	\$100	\$1,651,000	\$2,889,250				0	\$0	\$0	\$2,889,250	
7740		7740		SE Railroad Avenue	Fill in gaps in existing bicycle network with bike lanes.	SE 37th Avenue	SE Linwood Avenue	Collector		TSP	\$180	\$1,393,200	\$2,438,100				12	\$1,578,960	\$1,926,331	\$4,364,431	
300	1	200		Bicycle Overpass	Fill in gaps in existing bicycle network with bike lanes.	SE Railroad Avenue	SE International Way	Bridge/trail		TSP	\$90	\$15,750	\$27,563	20	\$1,100,000	\$1,925,000	20	\$59,500	\$72,590	\$2,025,153	
		0		Citywide	Bike friendly street grate design and installation	Citywide	Citywide			TSP	N/A									\$50,000	
		0		Citywide	Production and updating of a Milwaukee Bike Map	Citywide	Citywide			TSP	N/A									\$50,000	
4720		4720		Trolley Trail	Design/Plan and implement signage	Milwaukee Riverfront	South to City limits	Trail		TSP	\$7	\$30,680	\$53,690				0	\$0	\$0	\$53,690	
		0		SE Johnson Creek Boulevard/SE Linwood Avenue	Improve safety of crossing at intersection.	Location specific	Location specific			TSP	N/A									\$10,000	
		0		SE Linwood Avenue/SE King Road	Improve safety of crossing at intersection.	Location specific	Location specific			TSP	N/A									\$10,000	
4060		4060		SE Lake Road	Fill in gaps in existing bicycle network with bike lanes.	SE Main Street	SE Gullford Drive	Arterial		TSP	\$300	\$1,218,000	\$2,131,500				12	\$828,240	\$1,010,453	\$3,141,953	
1140		1140		SE Harrison Street	Fill in gaps in existing bicycle network with bike lanes.	Hwy 224	SE 42nd Avenue	Arterial		TSP	\$7	\$7,410	\$12,968				0	\$0	\$0	\$12,968	
		0		SE Linwood Avenue/SE Harmony Road	Improve safety of crossing at intersection.	Location specific	Location specific			TSP	N/A									\$10,000	
		0		SE International Way/SE Lake Road	Improve safety of crossing at intersection.	Location specific	Location specific			TSP	N/A									\$10,000	
3220		3220		SE 43rd Avenue	Fill in gaps in existing bicycle network with bike lanes.	SE King Road	SE Filbert Street	Collector		TSP	\$180	\$579,600	\$1,014,300				0	\$0	\$0	\$1,014,300	
		0		Citywide	Enhanced enforcement	Citywide	Citywide			TSP	N/A									\$10,000	
		0		Citywide	Re-striping of existing bike facilities	Citywide	Citywide			TSP	N/A									\$20,000	
		0		Citywide	Signage for Springwater Corridor	Citywide	Citywide			TSP	N/A									\$15,000	
450		450		SE Oatfield Road	Fill in gaps in existing bicycle network with bike lanes.	SE Gullford Court	SE Lake Road	Arterial		TSP	\$300	\$135,000	\$236,250				12	\$91,800	\$111,996	\$348,246	
3000		3000		SE Linwood Avenue	Fill in gaps in existing bicycle network with bike lanes.	SE Queen Road	SE Johnson Creek Blvd	Arterial		TSP	\$180	\$540,000	\$945,000				12	\$612,000	\$746,640	\$1,691,640	
		0		SE Linwood Avenue/SE Monroe Street	Improve safety of crossing at intersection.	Location specific	Location specific			TSP	N/A									\$10,000	
		0		SE Adams Street/SE 21st Avenue/Railroad crossing	Improve safety of crossing at intersection.	Location specific	Location specific			TSP	N/A									\$10,000	
525		525		SE Linwood Avenue	Fill in gaps in existing bicycle network with bike lanes.	SE Juniper Street	SE Harmony Road	Arterial		TSP	\$180	\$94,500	\$165,375				12	\$107,100	\$130,662	\$296,037	
1400		1400		SE Rusk Road	Fill in gaps in existing bicycle network with bike lanes.	SE Lake Road	North Clackamas Park	Arterial		TSP	\$240	\$336,000	\$588,000				12	\$285,600	\$348,432	\$936,432	
1330		1330		Kellogg Creek Trail	Improve connection of corridor	Milwaukee Riverfront	Treatment Plant	Trail		TSP	\$90	\$119,700	\$209,475				15	\$339,150	\$413,763	\$623,238	
		0		Monroe Street	Designation of Bike Boulevard streets and implementation of specific treatments for bicycles.	Citywide	Citywide	Collector		TSP	N/A									\$20,000	
		0		SE 29th Avenue/SE 37th Avenue/Harvey Street/SE 40th Avenue	Designation of Bike Boulevard streets and implementation of specific treatments for bicycles.	Citywide	Citywide			TSP	N/A									\$20,000	
		0		SE Stanley Avenue	Designation of Bike Boulevard streets and implementation of specific treatments for bicycles.	Citywide	Citywide	Collector		TSP	N/A									\$20,000	
2680		2680		37th Ave. Bike/Ped Improvement	Construct sidewalks and bike lanes. Key connection between Highway 224 and Harrison Street (Arterial).	Hwy 224	Harrison Street	Collector		RTP	\$300	\$804,000	\$1,407,000							\$1,407,000	
1330		1330		Kellogg Creek Trail	Construct low-impact trail-type sidewalk.	99-E	Miramonte Lodge			RTP	\$120	\$159,600	\$279,300				12	\$271,320	\$331,010	\$610,310	
		0		Downtown Station Area Streetscaping (21st & Main)	Reconstruct streetscape, including street trees, rain gardens, ADA ramps, street furniture, parking meters, and pedestrian-scale lighting.	TBD				RTP										\$0	
		0		Harrison Street Bikeway	Construct bike boulevard.	OR 99-E	King Road	Arterial		RTP										\$0	
		0		Kellogg Creek Dam Removal/Bridge Replacement/Milwaukee TC River Access Improvements	Remove dam and bridge; replace bridge with full bike and pedestrian facilities and a multi-use path undercrossing.	Washington	Adams			RTP										\$0	
5260		5260		King Road Boulevard Project	Construct boulevard, including new sidewalks, bus stop shelters, planter strips, medians, pedestrian scale lighting.	42nd Ave.	Linwood Ave.	Arterial		RTP	\$300	\$1,578,000	\$2,761,500							\$2,761,500	
1640		1640		OR 99-E Boulevard	Construct sidewalks and bike lanes, median strips, planter strips, and pedestrian scale lighting. Reconfigure or construct new signal for entrance to Riverfront Park.	Kellogg Creek Bridge	River Road	Regional Route		RTP	\$120	\$196,800	\$344,400							\$344,400	
9070		9070		Stanley N/S bike/ped route	Construct sidewalks and bike lanes. Key connection between Johnson Creek Boulevard, Harrison Street, and Harmony Road (Arterials).	Johnson Creek Blvd.	Railroad Ave.	Collector		RTP	\$300	\$2,721,000	\$4,761,750							\$4,761,750	
5650		5650		Main N/S Bike route	Construct	Harrison	Moore's	Collector		TSP	\$180	\$1,017,000	\$1,779,750				3	\$288,150	\$351,543	\$2,131,293	
											subtotal	\$13,239,940	\$23,169,895		\$1,100,000	\$1,925,000	subtotal	\$4,461,820	\$5,443,420		
													construction subtotal	\$14,339,940							
													contingency	\$10,754,955							
																			Total	\$31,068,315	

Auto Master Plan

Contingency (construction, design, admin)

Bridge Cost/SF

ROW Cost/SF staff+appraisals

DRAFT CONCEPT PLAN (JULY 2007)

75%

\$275

\$17

22%

Total Length (ft)	Number of Bridges	Total Bridge Length (ft)	Net Road Length	Name	Improvement	From	To	Functional Classification	Lanes		Cost/LF	Road Cost	w/ Contingency	Bridge Width (ft)	Bridge Cost	w/ Contingency	ROW Width (ft)	ROW Cost	w/ staff costs & appraisals	Cost		
			0	SE 17th Avenue/SE McLoughlin Boulevard	Prohibit left turn movement at SE 17th/SE McLoughlin Blvd and include in Refinement Plan	Location specific	Location specific	Regional Route	Auto	TSP	N/A									\$15,000		
600			600	SE 42 nd Avenue/Harrison St	Signalization of intersection	Location specific	Location specific	Arterial	Auto	TSP	\$240	\$144,000	\$252,000					\$0	\$0	\$252,000		
1200	1	160	1040	SE Johnson Creek Boulevard/32 nd Avenue	Signalization and new bridge structure	Location specific	Location specific	Arterial	Auto	TSP	\$240	\$249,600	\$436,800	60	\$2,640,000	\$4,620,000	0	\$0	\$0	\$5,056,800		
1600	1	1000	0	SE Harrison Street Overpass	Refinement Plan Option: Grade Separate from 224 and Railroad	SE 28th Avenue	SE 34th Street	Arterial	3	TSP	\$900	\$0	\$0	60	\$16,500,000	\$28,875,000				\$28,875,000		
				Highway 224 and SE McLoughlin Boulevard Refinement Plan	Conduct Refinement Plan for ORE 99E/ORE 224 focused on motor vehicle and freight mobility.	ORE 99E Project Limits: SE Tacoma Street to SE 17th Avenue	ORE 224 Project Limits: ORE 99E to SE Lake Road Interchange	Regional Route	Auto	TSP	N/A									TBD		
10500			10500	Highway 224 7-Lanes	Refinement Plan Option: Upgrade Highway 224 to a 7-lane facility	SE Harrison	SE Lake Road	Regional Route	7	TSP	\$1,300	\$13,650,000	\$23,887,500							\$23,887,500		
650			650	Highway 224/37th Avenue (Alt a)	Consolidate the two northern legs of SE 37 th Avenue and SE Industrial Way into one leg.	Location specific	Location specific	Regional Route	3	TSP	\$1,000	\$650,000	\$1,137,500				60	\$663,000	\$808,860	\$1,946,360		
300			300	Highway 224/37th Avenue (Alt b)	Consolidate the two northern legs of SE 37 th Avenue and SE Industrial Way into one leg.	Location specific	Location specific	Regional Route	3	TSP	\$1,000	\$300,000	\$525,000				60	\$306,000	\$373,320	\$898,320		
1200			1200	SE Johnson Creek Boulevard/Linwood Avenue	Add eastbound right turn, add westbound right turn	Location specific	Location specific	Arterial	Auto	TSP	\$240	\$288,000	\$504,000				12	\$244,800	\$298,656	\$802,656		
300			300	SE Johnson Creek Boulevard/SE 32nd Avenue	Install roundabout and Approaches	Location Specific	Location Specific	Arterial	Auto	TSP	\$1,000	\$300,000	\$525,000				3	\$15,300	\$18,666	\$543,666		
650			650	SE Harrison Street/Main Street	Add westbound shared through/right turn lane: or (Striping only)	Location specific	Location specific	Arterial	Auto	TSP	\$30	\$19,500	\$34,125				0	\$0	\$0	\$34,125		
650			650	SE Harrison Street/Main Street	Add eastbound right turn lane (Striping Only)	Location specific	Location specific	Arterial	Auto	TSP	\$30	\$19,500	\$34,125				0	\$0	\$0	\$34,125		
			0	SE Linwood Avenue/King Road	Implement protected/permissive left turn phasing for northbound and southbound approaches	Location specific	Location specific	Arterial	Auto	TSP	N/A						0	\$0	\$0	\$15,500		
8740	1	100	8640	SE Linwood Avenue	Upgrade to current city standards for 3-lane arterial	SE Johnson Creek Boulevard	SE Harmony Road	Arterial	3	TSP	\$900	\$7,776,000	\$13,608,000	60	\$1,650,000	\$2,887,500	19	\$2,790,720	\$3,404,678	\$19,900,178		
7780			7780	SE Rail Road Avenue	Upgrade to current city standards for 3-lane collector	SE Linwood Avenue	SE 37th Avenue	Collector	3	TSP	\$800	\$6,224,000	\$10,892,000				13	\$1,719,380	\$2,097,644	\$12,989,644		
300			300	SE River Road/SE McLoughlin Boulevard	Consolidate a single access point for the area at SE Bluebird Road with full intersection treatment and signalization: or	Location specific	Location specific	Regional Route	3	TSP	\$1,000	\$300,000	\$525,000				60	\$306,000	\$373,320	\$898,320		
300			300	SE River Road/SE McLoughlin Boulevard	Add second NB Left-turn lane at SE River Road	Location specific	Location specific	Arterial	3	TSP	\$240	\$72,000	\$126,000				31.2	\$159,120	\$194,126	\$320,126		
1270	3		1270	SE Harrison Street	Capacity improvement project to upgrade SE Harrison Street to a three-lane arterial cross section standard from SE 21st Avenue to SE Oatfield Road	SE 32nd Street	SE 42nd Street	Arterial	3	TSP	\$1,000	\$1,270,000	\$2,222,500				13	\$280,670	\$342,417	\$2,564,917		
			0	SE Harrison/Highway 224	Add left turn-lanes and protected signal phasing on SE Harrison Street approaches	Location specific	Location specific	Regional Route	Auto	TSP	N/A									\$20,000		
3660			3660	SE Lake Road	Capacity improvement project to upgrade SE Lake Road to a three-lane arterial cross section standard from SE 21st Avenue to SE Oatfield Road	SE 21st Avenue	SE Oatfield Road	Arterial	3	TSP	\$1,000	\$3,660,000	\$6,405,000				13	\$808,860	\$986,809	\$7,391,809		
2670			2670	SE Johnson Creek Boulevard Capacity & Signalization	Replace 3-way stops with signals, add turn pockets.	SE 32 nd Street	SE 42 nd Street	Arterial	3	TSP	From RTP									\$1,500,000		
100			250	SE Harrison Street/SE King Road Connection	Enhance connection along SE Linwood Avenue at SE King Road	Location Specific	Location Specific	Arterial	Auto	TSP	\$120	\$30,000	\$52,500							\$52,500		
			0	SE Oak Street/Highway 224	Add left turn-lanes and protected signal phasing on SE Oak Street approaches	Location specific	Location specific	Regional Route	Auto	TSP	N/A									\$20,000		
750			750	Highway 224/ Freeman Way	Remove Signal and Implement Right in Right out access restrictions	Location Specific	Location Specific	Regional Route	Auto	TSP	\$1,000	\$750,000	\$1,312,500				0	\$0	\$0	\$1,312,500		
250			250	SE Linwood Avenue Connectivity	Enhance connection along SE Linwood Avenue at SE King Road	Location Specific	Location Specific	Collector	2	TSP	\$120	\$30,000	\$52,500							\$52,500		
250			250	SE Linwood Avenue Connectivity	Enhance connection along SE Linwood Avenue at SE Monroe Street	Location Specific	Location Specific	Collector	2	TSP	\$120	\$30,000	\$52,500							\$52,500		
			0	SE Harrison Street Rail Crossing	Railroad crossing safety project at SE Harrison Street	Location specific	Location specific	Arterial	Auto	TSP	N/A									\$50,000		
			0	SE Oak Street Rail Crossing	Railroad crossing safety project at SE Oak Street	Location specific	Location specific	Collector	Auto	TSP	N/A									\$50,000		
			0	Se 37th Avenue Rail Crossing	Railroad crossing safety project at SE 37th Avenue	Location specific	Location specific	Collector	Auto	TSP	N/A									\$50,000		
			0	SE Linwood Avenue/Harmony Road/Lake Road	This intersection is currently undergoing an environmental assessment to determine appropriate long term mitigation. Improvements assumed in this study included:	Location specific	Location specific	Arterial	Auto	RTP	From RTP									\$20,000,000		
			0	SE Linwood Avenue/Harmony Road/Lake Road	Grade separate Harmony Road from Union Pacific Railroad and align Harmony Road as a through east west movement.	Location specific	Location specific	Arterial	Auto	RTP	From RTP											
			0	SE Linwood Avenue/Harmony Road/Lake Road	Align Linwood Road as a T-intersection with the realigned Harmony Road.	Location specific	Location specific	Arterial	Auto	RTP	From RTP											
			0	SE Johnson Creek Boulevard	Widen to three to five lanes and widen bridge over Johnson Creek	SE 45 th Avenue	SE 82 nd Avenue	Arterial	Auto	RTP	From RTP									\$40,783,000		
			0	Harmony Road	Widen to five lanes to improve safety and accessibility	SE Sunnyside Road	Hwy 224	Arterial	Auto	RTP	From RTP									\$23,400,000		
			0	Kellogg Creek (Oatfield Road) Bridge Replacement	construct two lane bridge with sidewalks and bike lanes	Kellogg Creek	n/a	Arterial	Auto	RTP	From RTP									\$4,703,000		
												subtotal	\$15,281,600	\$26,742,800								
															construction subtotal	\$20,790,000	\$36,382,500					
															contingency	\$36,071,600						
																\$27,053,700						
																		Total	\$61,733,636			