

RELATIONS IN THE WITT GROUP OF NONDEGENERATE
BRAIDED FUSION CATEGORIES ARISING FROM THE
REPRESENTATION THEORY OF QUANTUM GROUPS
AT ROOTS OF UNITY

by

ANDREW P. SCHOPIERAY

A DISSERTATION

Presented to the Department of Mathematics
and the Graduate School of the University of Oregon
in partial fulfillment of the requirements
for the degree of
Doctor of Philosophy

June 2017

DISSERTATION APPROVAL PAGE

Student: Andrew P. Schopieray

Title: Relations in the Witt Group of Nondegenerate Braided Fusion Categories
Arising from the Representation Theory of Quantum Groups at Roots of Unity

This dissertation has been accepted and approved in partial fulfillment of the requirements for the Doctor of Philosophy degree in the Department of Mathematics by:

Victor Ostrik	Chair
Arkady Berenstein	Core Member
Alexander Kleshchev	Core Member
Alexander Polishchuk	Core Member
Dietrich Belitz	Institutional Representative

and

Scott Pratt	Dean of the Graduate School
-------------	-----------------------------

Original approval signatures are on file with the University of Oregon Graduate School.

Degree awarded June 2017

© 2017 Andrew P. Schopieray

DISSERTATION ABSTRACT

Andrew P. Schopieray

Doctor of Philosophy

Department of Mathematics

June 2017

Title: Relations in the Witt Group of Nondegenerate Braided Fusion Categories Arising from the Representation Theory of Quantum Groups at Roots of Unity

For each finite dimensional Lie algebra \mathfrak{g} and positive integer k there exists a modular tensor category $\mathcal{C}(\mathfrak{g}, k)$ consisting of highest weight integrable $\hat{\mathfrak{g}}$ -modules of level k where $\hat{\mathfrak{g}}$ is the corresponding affine Lie algebra. Relations between the classes $[\mathcal{C}(\mathfrak{sl}_2, k)]$ in the Witt group of nondegenerate braided fusion categories have been completely described in the work of Davydov, Nikshych, and Ostrik. Here we give a complete classification of relations between the classes $[\mathcal{C}(\mathfrak{sl}_3, k)]$ relying on the classification of connected étale algebras in $\mathcal{C}(\mathfrak{sl}_3, k)$ ($SU(3)$ modular invariants) given by Gannon. We then give an upper bound on the levels for which exceptional connected étale algebras may exist in the remaining rank 2 cases ($\mathcal{C}(\mathfrak{so}_5, k)$ and $\mathcal{C}(\mathfrak{g}_2, k)$) in hopes of a future classification of Witt group relations among the classes $[\mathcal{C}(\mathfrak{so}_5, k)]$ and $[\mathcal{C}(\mathfrak{g}_2, k)]$. This dissertation contains previously published material.

CURRICULUM VITAE

NAME OF AUTHOR: Andrew P. Schopieray

GRADUATE AND UNDERGRADUATE SCHOOLS ATTENDED:

University of Oregon, Eugene, Oregon
Western Washington University, Bellingham, Washington
Grand Valley State University, Allendale, Michigan
Northwestern Michigan College, Traverse City, Michigan

DEGREES AWARDED:

Doctor of Philosophy, Mathematics, 2017, University of Oregon
Master of Science, Mathematics, 2012, Western Washington University
Bachelor of Science, Mathematics, 2010, Grand Valley State University
Associate of Applied Science, 2007, Northwestern Michigan College

AREAS OF SPECIAL INTEREST:

Quantum Algebra
Representation Theory

PROFESSIONAL EXPERIENCE:

Graduate Teaching Fellow, Department of Mathematics, University of Oregon, 2012–2017
Instructor, University of Oregon Center for Youth Enrichment/Talented and Gifted Education, 2013–2015
Instructor, Whatcom Community College, 2011–2012
Graduate Teaching Assistant, Western Washington University, 2010–2012

PUBLICATIONS:

Andrew Schopieray. Classification of \mathfrak{sl}_3 relations in the Witt group of nondegenerate braided fusion categories. *Communications in Mathematical Physics*, 353(3):1103–1127, 2017
Andrew Schopieray. Level bounds for exceptional quantum subgroups in rank two. *submitted for publication*, 2017

ACKNOWLEDGEMENTS

There are too many people who deserve recognition for their contributions in my life up to this point, so I will mention only those major characters who haven't been acknowledged previously in print, and had a substantial role in my intellectual upbringing. Most likely you will all be thanked in future publications that will have higher readership.

The lion's share of gratitude for my research is owed to my advisor, Victor Ostrik. Despite how little credit he would willfully claim for my successes, Victor has served as a source of inspiration and leadership since we met and burned through Humphreys in the winter of 2014. Every established researcher I have met in this field has a similar respect and gratitude, and I consider myself very privileged to call myself his student.

Next in the reverse chronological order of thanks comes Matt Boelkins who, in 2009, informed an ungrateful and misguided undergraduate student that mathematics can be a career. For that he will have to deal with me thanking him *ad infinitum*.

While I was still cooking professionally 12-hours each day, Jim Valovick showed me that open-mindedness and compassion are fundamental to the human experience. He would go on to teach me philosophy, religion, and Latin, before his passing in 2007. It's with tears in my eyes that I yet again thank him indirectly, having not matured enough to be able to tell him face-to-face when I had the chance.

Lastly my thanks go to Cheney, who everyone already knows, because like a little boy I still go on and on about "how cool my big brother is". Dings and dents included, you'll always be the spitting image of what I aspire to achieve.

TABLE OF CONTENTS

Chapter	Page
I. INTRODUCTION	1
II. PRELIMINARIES	4
2.1. Fusion Subcategories and Prime Decomposition	6
2.2. Modular Categories	7
2.3. Étale Algebras	9
2.4. The Witt Group of Nondegenerate Braided Fusion Categories	11
III. QUANTUM GROUPS TO MODULAR TENSOR CATEGORIES	13
3.1. Numerical Data and Fusion Rules for $\mathcal{C}(\mathfrak{g}, k)$ when $\text{rank}(\mathfrak{g}) \leq 2$	15
3.2. $\mathcal{C}(\mathfrak{sl}_3, k)$	22
3.2.1. Fusion Subcategories of $\mathcal{C}(\mathfrak{sl}_3, k)$	23
3.2.2. Prime Decomposition when $3 \nmid k$	24
3.2.3. Simplicity of $\mathcal{C}(\mathfrak{sl}_3, k)_A^0$ when $3 \mid k$	27
IV. WITT GROUP RELATIONS	34
4.1. Modular Invariants and Conformal Embeddings	34
4.2. A Classification of \mathfrak{sl}_3 Relations	38
V. CONNECTED ÉTALE ALGEBRAS IN $\mathcal{C}(\mathfrak{g}, k)$	43
5.1. Technical Machinery	43
5.2. Exceptional Algebras	48
5.3. Proof of Theorem 5: $\mathcal{C}(\mathfrak{so}_5, k)$	52
5.3.1. The Case $m = 0$ and $0 < \ell < k - 1$	53
5.3.2. The Case $2 \leq m \leq x + 2$	55
5.3.3. The Case $\ell = 0$ and $m < k$	57
5.3.4. The Case $0 \neq \ell \leq x < m - 2$	58
5.4. Proof of Theorem 5: $\mathcal{C}(\mathfrak{g}_2, k)$	61
5.4.1. The Case $0 \leq \ell \leq 2$	62
5.4.2. The Case $m = 0$	65
5.4.3. The Case $3 \leq \ell \leq x + 3$	66
5.4.4. The Case $x + 3 < \ell$ and $m \neq 0$	69
REFERENCES CITED	72

LIST OF FIGURES

Figure	Page
1. Roots of unity q when $\text{rank}(\mathfrak{g}) \leq 2$	13
2. Modulus of $q^m - q^{-m}$	14
3. $\mathcal{C}(\mathfrak{sl}_2, 6)$	15
4. $\mathcal{C}(\mathfrak{sl}_3, 4)$	16
5. $\mathcal{C}(\mathfrak{so}_5, 6)$	17
6. $\mathcal{C}(\mathfrak{g}_2, 8)$	18
7. $\lambda \otimes \gamma \in \mathcal{C}(\mathfrak{so}_5, 12)$	21
8. Adjacent vs. nonadjacent to T_i (level $k = 5$)	24
9. \mathcal{C}_A^0 at level $k = 6$ and the action of a corner weight	27
10. $(3, 4) \otimes (4, 3) \in \mathcal{C}(\mathfrak{sl}_3, 12)$	51
11. Possible (ℓ, m) when $k = 14$ and $x = 5$	53
12. $(6, 0) \otimes (7, 0) \in \mathcal{C}(\mathfrak{so}_5, 9)$	54
13. $(6, 0) \otimes (7, 4) \in \mathcal{C}(\mathfrak{so}_5, 12)$	56
14. $(0, 10) \otimes (0, 10) \in \mathcal{C}(\mathfrak{so}_5, 11)$	57
15. $(0, 6) \otimes (3, 7) \in \mathcal{C}(\mathfrak{so}_5, 10)$	59
16. Possible (ℓ, m) when $k = 20$ and $x = 5$	62
17. $(0, 5) \otimes (0, 6) \in \mathcal{C}(\mathfrak{g}_2, 18)$	63
18. $(9, 0) \otimes (15, 0) \in \mathcal{C}(\mathfrak{g}_2, 20)$	65
19. $(0, 4) \otimes (3, 4) \in \mathcal{C}(\mathfrak{g}_2, 15)$	67
20. $(12, 0) \otimes (14, 4) \in \mathcal{C}(\mathfrak{g}_2, 24)$	70

CHAPTER I

INTRODUCTION

This dissertation is a compilation of two existing articles. Chapters II and IV have appeared in [41] (the final publication is available at Springer via <http://dx.doi.org/10.1007/s00220-017-2831-z>), Chapter V has appeared in [42] which has been submitted for publication, and Chapters I and III include overlapping portions of both [41] and [42].

The Witt group of nondegenerate braided fusion categories \mathcal{W} , first introduced in [10], provides an algebraic structure that is one tool for organizing braided fusion categories. Inside \mathcal{W} lies the subgroup \mathcal{W}_{un} consisting of classes of pseudo-unitary braided fusion categories which, in turn, contains the classes $[\mathcal{C}(\mathfrak{g}, k)]$ coming from the representation theory of affine Lie algebras. Theorem 3 is the main goal of this exposition, to classify all relations in the Witt group between the classes $[\mathcal{C}(\mathfrak{sl}_3, k)]$. To do so requires identification of a unique (up to braided equivalence) representative of each Witt equivalence class which is simple and completely anisotropic (see Definitions 3 and 8), constructed in the cases where $3 \mid k$ as the category of dyslectic A -modules $\mathcal{C}(\mathfrak{sl}_3, k)_A^0$ [27, Definition 1.8]. The major result which allows for the classification is Theorem 1 which states that the categories $\mathcal{C}(\mathfrak{sl}_3, k)_A^0$ are simple when $3 \mid k$ and $k \neq 3$.

Translated into the language of modular tensor categories, there is a common belief among physicists [30] that \mathcal{W}_{un} is generated by the classes of the categories $\mathcal{C}(\mathfrak{g}, k)$. This provides at least one external motivation for understanding Witt group relations in \mathcal{W}_{un} . But Witt group relations are difficult to come by; all relations in the subgroup $\mathcal{W}_{\text{pt}} \subset \mathcal{W}$ consisting of pointed braided fusion categories are known [14, Appendix A.7] and limited relations in \mathcal{W}_{un} are known due to the theory of conformal embeddings of vertex operator algebras (Section 4.1.). The

general task of classifying all relations in \mathcal{W}_{un} was presented in [10], and in [11] all relations among the classes of the categories $\mathcal{C}(\mathfrak{sl}_2, k)$ were classified. Independent from the classification of Witt group relations, the passage from $[\mathcal{C}] \in \mathcal{W}_{\text{un}}$ to $[\mathcal{C}_A^0]$, the equivalence class of the category of dyslectic A -modules over a connected étale algebra, is intimately related to extensions of vertex operator algebras [24] and anyon condensation [21] (see also [15, 29]), providing stronger justification to conjecture and prove results similar to Theorem 3 for general $\mathcal{C}(\mathfrak{g}, k)$. If these results are true they also provide an infinite collection of simple modular tensor categories which play an important role in the classification of all modular tensor categories, an open and active area of modern research.

Modular tensor categories also encode the data of chiral conformal field theories. Fuchs, Runkel, and Schweigert [19] describe how *full* conformal field theories correspond to certain commutative algebras in these categories. These concepts have been recently formalized to *logarithmic* conformal field theories [20], i.e. theories described by non-semisimple analogs of modular tensor categories. One should also refer to the work of Böckenhauer, Evans, and Kawahigashi [4, 5] which describes this connection in terms of modular invariants and subfactor theory, or Ostrik's summary of these results in categorical terms [35, Section 5].

Lastly, the aforementioned connected étale algebras partially classify *module categories* over fusion categories. Each connected étale algebra $A \in \mathcal{C}$ gives rise to an indecomposable module category over \mathcal{C} by considering \mathcal{C}_A , the category of A -modules in \mathcal{C} , although not all indecomposable module categories can be produced in this way. For example if \mathcal{C} is a *pointed* modular tensor category [17, Chapter 8.4] with the set of isomorphism classes of simple objects of \mathcal{C} forming a finite abelian group G , then indecomposable module categories over \mathcal{C} correspond to subgroups of G along with additional cohomological data [34, Theorem 3.1]; this example provides some precedence to title connected étale algebras as *quantum subgroups*. For a non-modular example, module categories over the even parts of the Haagerup subfactors have been classified by Grossman and Snyder [23]. More

classically, module categories over $\mathcal{C}(\mathfrak{sl}_2, k)$ are classified by simply-laced Dynkin diagrams [7, 27] but this characterization scheme has not immediately lent itself to classifying module categories over $\mathcal{C}(\mathfrak{g}, k)$ for other simple Lie algebras \mathfrak{g} . The language and tools of tensor categories which have solidified in recent years provide a novel approach to this dated problem.

There is a long-standing belief that the modular tensor categories $\mathcal{C}(\mathfrak{g}, k)$ contain *exceptional* (see Section 5.2.) connected étale algebras at only finitely many levels k . Here in Theorem 5 we confirm this conjecture when $\mathfrak{g} = \mathfrak{so}_5, \mathfrak{g}_2$, contributing a proof and explicit bounds, adding to the previously known positive results for \mathfrak{sl}_2 [27] and \mathfrak{sl}_3 [22]. The explicit level-bound provided optimistically allows for a complete classification of connected étale algebras in $\mathcal{C}(\mathfrak{so}_5, k)$ and $\mathcal{C}(\mathfrak{g}_2, k)$ by strictly computational methods.

CHAPTER II

PRELIMINARIES

Chapter II appeared in [41] (the final publication is available at Springer via <http://dx.doi.org/10.1007/s00220-017-2831-z>).

We assume familiarity with the basic definitions and results found for example in [17], but will give a brief recollection at this point. In the remainder of this section \mathbb{k} will be an algebraically closed field of characteristic zero.

A *fusion category* over \mathbb{k} is a \mathbb{k} -linear semisimple rigid tensor category with finitely many isomorphism classes of simple objects, finite dimensional spaces of morphisms, and a simple unit object $\mathbf{1}$. For brevity, the set of isomorphism classes of simple objects of a fusion category \mathcal{C} will be denoted $\mathcal{O}(\mathcal{C})$. We will identify the unique (up to tensor equivalence) fusion category with one simple object with Vec , the category of finite dimensional vector spaces over \mathbb{k} . Given two braided fusion categories \mathcal{C} and \mathcal{D} , *Deligne's tensor product* $\mathcal{C} \boxtimes \mathcal{D}$ is a new braided fusion category which can be realized as the completion of the \mathbb{k} -linear direct product $\mathcal{C} \otimes_{\mathbb{k}} \mathcal{D}$ under direct sums and subobjects under our current assumptions [17, Section 4.6].

A set of natural isomorphisms

$$c_{X,Y} : X \otimes Y \xrightarrow{\sim} Y \otimes X \tag{1}$$

satisfying compatibility relations [17, Section 8.1] for all X, Y in a fusion category \mathcal{C} is called a *braiding* on \mathcal{C} and we will therefore refer to \mathcal{C} as a *braided fusion category*. There is an alternative *reverse braiding* for any braided category given by $\tilde{c}_{X,Y} := c_{Y,X}^{-1}$ and the resulting braided category is denoted \mathcal{C}^{rev} .

Example 1 (Pointed fusion categories). Special distinction goes to fusion

categories \mathcal{C} in which every object $X \in \mathcal{O}(\mathcal{C})$ is *invertible*, i.e. the *evaluation* $\text{ev}_X : X^* \otimes X \rightarrow \mathbf{1}$ and *coevaluation* $\text{coev}_X : \mathbf{1} \rightarrow X \otimes X^*$ maps coming from the rigidity of \mathcal{C} are isomorphisms. Categories in which every $X \in \mathcal{O}(\mathcal{C})$ is invertible are called *pointed*, while the maximal pointed subcategory of a braided fusion category \mathcal{C} will be denoted \mathcal{C}_{pt} . Pointed braided fusion categories were classified by Joyal and Street in [26, Section 3] (see also [17, Section 8.4]). If a pointed fusion category is braided, due to (1) the set of isomorphism classes of simple objects forms a finite abelian group under the tensor product, which we will call A . Recall that a quadratic form on A with values in \mathbb{k}^\times is a function $q : A \rightarrow \mathbb{k}^\times$ such that $q(-x) = q(x)$ and $b(x, y) = q(x + y)/(q(x)q(y))$ is bilinear for all $x, y \in A$. To each pair (A, q) there exists a braided fusion category $\mathcal{C}(A, q)$ that is unique up to braided equivalence whose simple objects are labelled by the elements of A .

One might identify symmetric braidings (those for which $c_{Y,X} \circ c_{X,Y} = \text{id}_{X \otimes Y}$) as the most elementary of braidings as Deligne [12][13][17, Section 9.9] proved that all symmetric fusion categories must come from the representation theory of finite groups. In the spirit of gauging how far a braiding is from being symmetric, if $c_{Y,X} \circ c_{X,Y} = \text{id}_{X \otimes Y}$ for any objects $X, Y \in \mathcal{C}$, we say X and Y *centralize* one another [32, Section 2.2].

Definition 1. If \mathcal{D} is a subcategory of a braided fusion category \mathcal{C} that is closed under tensor products then $\mathcal{D}' \subset \mathcal{C}$ the *centralizer of \mathcal{D} in \mathcal{C}* is the full subcategory of objects of \mathcal{C} that centralize each object of \mathcal{D} . A braided fusion category is known as *nondegenerate* if $\mathcal{C}' \simeq \text{Vec}$.

Note 1. One can think of nondegenerate braided fusion categories as those which are furthest from symmetric as possible.

Example 2 (Metric groups). If the symmetric bilinear form $b(-, -)$ associated with a pair (A, q) (as in Example 1) is nondegenerate, then the pair (A, q) is called a *metric group*. It is known [17, Example 8.13.5] that the category $\mathcal{C}(A, q)$ is

nondegenerate if and only if (A, q) is a metric group. For instance let $A := \mathbb{Z}/3\mathbb{Z}$ (considered as the set $\{0, 1, 2\}$ with the operation of addition modulo 3). The following functions are quadratic forms on A with values in \mathbb{C}^\times :

$$\begin{array}{ll} q_\omega : A \longrightarrow \mathbb{C}^\times & q_{\omega^2} : A \longrightarrow \mathbb{C}^\times \\ x \mapsto (\omega)^{x^2} & x \mapsto (\omega^2)^{x^2} \end{array}$$

where $\omega = \exp(2\pi i/3)$. These quadratic forms equip $\mathcal{C}(\mathbb{Z}/3\mathbb{Z}, q_\omega)$ and $\mathcal{C}(\mathbb{Z}/3\mathbb{Z}, q_{\omega^2})$ with the structure of nondegenerate braided fusion categories which are not braided equivalent.

2.1. Fusion Subcategories and Prime Decomposition

The assumptions required of a fusion subcategory are very few in number.

Definition 2. A full subcategory \mathcal{D} of a fusion category \mathcal{C} is a *fusion subcategory* if \mathcal{D} is closed under tensor products.

It would not be unreasonable to assume that rigidity and existence of the unit object of \mathcal{D} be required in the definition above, but both are consequences of closure under tensor products. Specifically Lemma 4.11.3 of [17] gives that for each simple object X there exists $n \in \mathbb{Z}_{>0}$ such that $\text{Hom}(\mathbf{1}, X^{\otimes n}) \neq 0$. And by adjointness of duality [17, Proposition 2.10.8] $\text{Hom}(X^*, X^{\otimes(n-1)}) \neq 0$ as well. Thus $\mathbf{1}, X^* \in \mathcal{C}$ are direct summands of sufficiently large tensor powers of X .

Definition 3. A fusion category with no proper, nontrivial fusion subcategories is called *simple*, while a nondegenerate fusion category with no proper, nontrivial, nondegenerate fusion subcategories is called *prime*.

The existence of a decomposition of a nondegenerate braided fusion category into a product of prime fusion subcategories was given by Müger [32, Section 4.1]

under limited assumptions and proved in the following generality in Theorem 3.13 of [14].

Proposition 1. *Let $\mathcal{C} \neq \text{Vec}$ be a nondegenerate braided fusion category. Then*

$$\mathcal{C} \simeq \mathcal{C}_1 \boxtimes \cdots \boxtimes \mathcal{C}_n,$$

where $\mathcal{C}_1, \dots, \mathcal{C}_n$ are prime nondegenerate subcategories of \mathcal{C} .

To construct such a decomposition one can identify a nontrivial nondegenerate braided fusion subcategory \mathcal{D} inside of a given nondegenerate braided fusion category \mathcal{C} and by Theorem 4.2 of [32], $\mathcal{C} \simeq \mathcal{D} \boxtimes \mathcal{D}'$ is a braided equivalence. In future sections this process will be referred to as *Müger's decomposition*. As noted in [32, Remark 4.6] this decomposition is not necessarily unique which is a significant observation for the discussion in Section 2.4..

2.2. Modular Categories

Recall the natural isomorphisms $a_V : V \xrightarrow{\sim} V^{**}$ for any finite dimensional vector space V over \mathbb{k} from elementary linear algebra. This collection of natural isomorphisms is a *pivotal structure* on Vec , i.e. they satisfy $a_{V \otimes W} = a_V \otimes a_W$ for any finite dimensional vector spaces V and W . A pivotal structure on a general tensor category \mathcal{C} allows us to define a categorical analog of *trace*, $\text{Tr}(f) \in \mathbb{k}$ for any morphism $f \in \text{End}(X)$ [17, Section 4.7] given by

$$\text{Tr}(f) : \mathbf{1} \xrightarrow{\text{coev}_X} X \otimes X^* \xrightarrow{a_X \circ f \otimes \text{id}_{X^*}} X^{**} \otimes X^* \xrightarrow{\text{ev}_{X^*}} \mathbf{1}.$$

Tensor categories with a pivotal structure $a_X : X \xrightarrow{\sim} X^{**}$ for all objects X will be called *pivotal* themselves.

Definition 4. The (categorical or quantum) *dimension* of an object X in a pivotal tensor category \mathcal{C} is $\dim(X) := \text{Tr}(\text{id}_X) \in \mathbb{k}$. A pivotal structure on a tensor

category is called *spherical* if $\dim(X) = \dim(X^*)$ for all $X \in \mathcal{O}(\mathcal{C})$, while spherical braided fusion categories are called *pre-modular*. One can define the dimension of a pre-modular category by

$$\dim(\mathcal{C}) := \sum_{X \in \mathcal{O}(\mathcal{C})} \dim(X)^2.$$

Example 3 (Vector spaces). There is only one simple object in Vec up to isomorphism, the one-dimensional \mathbb{k} -vector space $\mathbf{1}$, and the aforementioned pivotal structure $a_V : V \xrightarrow{\sim} V^{**}$ given by $v \mapsto \{f \mapsto f(v)\}$ is spherical. It is easily verified that $\dim(\mathbf{1}) = 1$ and because the categorical notion of dimension is additive, then in this case the categorical dimension matches the usual notion of the dimension of a \mathbb{k} -vector space.

More generally the categories $\mathcal{C}(A, q)$ are pointed, and so the evaluation, coevaluation, and spherical structure can be realized by identity maps. So $\dim(X) = 1$ for all $X \in \mathcal{O}(\mathcal{C}(A, q))$ and all metric groups (A, q) . Moreover $\dim(\mathcal{C}(A, q)) = |A|$.

There is a second notion of dimension defined in terms of the Grothendieck ring $K(\mathcal{C})$ of a fusion category \mathcal{C} . As noted in Section 3.3 of [17], there exists a unique ring homomorphism $\text{FPdim} : K(\mathcal{C}) \rightarrow \mathbb{R}$ such that $\text{FPdim}(X) > 0$ for any $0 \neq X \in \mathcal{C}$. This *Frobenius-Perron dimension* gives an analog to the dimension of the category \mathcal{C} itself as in Definition 4, given by

$$\text{FPdim}(\mathcal{C}) := \sum_{X \in \mathcal{O}(\mathcal{C})} \text{FPdim}(X)^2.$$

Spherical fusion categories for which $\text{FPdim}(\mathcal{C}) = \dim(\mathcal{C})$ are called *pseudo-unitary* and it is known that for such a category there exists a unique spherical structure with $\text{FPdim}(X) = \dim(X)$ for all $X \in \mathcal{O}(\mathcal{C})$, allowing us to only consider $\dim(X)$ in these cases. It will be important to future computations that $\dim(X) > 0$ for pseudo-unitary fusion categories.

If a braided fusion category is equipped with a spherical structure, there exist

natural isomorphisms $\theta_X : X \xrightarrow{\sim} X$ for all $X \in \mathcal{C}$ known as *twists* (or the ribbon structure) compatible with the braiding isomorphisms found in (1) of Section II [17, Section 8.10]. In the case of pointed fusion categories $\mathcal{C}(A, q)$ (Example 1), for any $x \in A$ the map $\theta_x = b(x, x)\text{id}_x$ defines a ribbon structure. The diagonal matrix consisting of the twists θ_X over all $X \in \mathcal{O}(\mathcal{C})$ is called the T -matrix of \mathcal{C} .

Finally we end this subsection by tying the notions of trace and dimension in spherical categories to the nondegeneracy conditions defined by the centralizer construction (Definition 1).

Definition 5. The S -matrix of a pre-modular category \mathcal{C} is the matrix $(s_{X,Y})_{X,Y \in \mathcal{O}(\mathcal{C})}$ where $s_{X,Y} := \text{Tr}(c_{Y,X} \circ c_{X,Y})$. A pre-modular category is *modular* if the determinant of its S -matrix is nonzero.

Note 2. It is well-known that a pre-modular category \mathcal{C} is modular if and only if it is nondegenerate ($\mathcal{C}' = \text{Vec}$). [14, Proposition 3.7][32]

2.3. Étale Algebras

For this exposition, an *algebra* A in a fusion category \mathcal{C} is an associative algebra with unit which is equipped with a multiplication map $m : A \otimes A \rightarrow A$. If m splits as a morphism of A -bimodules, we refer to A as *separable*. This criterion ensures that \mathcal{C}_A , the category of right A -modules is semisimple, and also ${}_A\mathcal{C}$, ${}_A\mathcal{C}_A$, the categories of left A -modules and A -bimodules respectively [10, Proposition 2.7].

Definition 6. An algebra A in a fusion category \mathcal{C} is *étale* if it is both commutative and separable. This algebra is *connected* if $\dim_{\mathbb{k}} \text{Hom}(\mathbf{1}, A) = 1$.

Note 3. Étale algebras have also been referred to as *condensable* algebras in the physics literature. The following description of the categories \mathcal{C}_A when A is connected étale is summarized from Sections 3.3 and 3.5 of [10].

Braidings on \mathcal{C} give rise to functors $G : \mathcal{C}_A \rightarrow {}_A\mathcal{C}_A$ defined as $M \mapsto M_-$ (the identity map as right A -modules), where the left A -module structure on M_- is

given as composition of the reverse braiding with the right A -module structure map ρ :

$$A \otimes M \xrightarrow{\tilde{c}_{M,A}} M \otimes A \xrightarrow{\rho} M.$$

The commutativity of A implies ${}_A\mathcal{C}_A$ is a tensor category and thus the above functor G provides a tensor structure for \mathcal{C}_A which we denote \otimes_A . One can also define a tensor structure, opposite to the one above, on \mathcal{C}_A by composing the right A -module structure map with the usual braiding. We will denote the resulting left A -module produced from M as M_+ .

With the tensor structure defined on \mathcal{C}_A by the functor G , the free module functor $F : \mathcal{C} \rightarrow \mathcal{C}_A$ is a tensor functor. In particular $F(\mathbf{1}) = A$ is the unit object of \mathcal{C}_A which is simple by the assumption that A is connected. The category \mathcal{C}_A is also rigid since any object $M \in \mathcal{C}_A$ is a direct summand of the rigid object

$$F(M) = M \otimes A = M \otimes_A (A \otimes A).$$

The above discussion implies \mathcal{C}_A is a fusion category when $A \in \mathcal{C}$ is connected étale. Unfortunately the category \mathcal{C}_A is *not* braided in general. The issue lies in the inherent *choice* of a left A -module structure on a given right A -module $M \in \mathcal{C}_A$.

Definition 7. If $\text{id}_M : M_- \rightarrow M_+$ is an isomorphism of A -bimodules for $M \in \mathcal{C}_A$, we say that M is *dyslectic* (also called *local* in the literature).

Pareigis [37] originally studied the full subcategory of \mathcal{C}_A consisting of dyslectic A -modules, denoted by \mathcal{C}_A^0 which is the correct subcategory of \mathcal{C}_A to study to ensure a braiding exists (see also [27]). That is if \mathcal{C} is a braided fusion category and $A \in \mathcal{C}$ a connected étale algebra, then \mathcal{C}_A^0 is a braided fusion category and furthermore if \mathcal{C} is nondegenerate then \mathcal{C}_A^0 is nondegenerate as well.

Definition 8. A braided fusion category \mathcal{C} is *completely anisotropic* if the only connected étale algebra in \mathcal{C} is the unit object $\mathbf{1}$.

2.4. The Witt Group of Nondegenerate Braided Fusion Categories

Tensor categories are often regarded as a categorical analog of rings and there is a categorical construction which (in some ways) mimics the center of a ring. The *Drinfeld center* of a monoidal (tensor, fusion) category \mathcal{C} is the category whose objects are pairs $(X, \{\gamma_{X,Y}\}_{Y \in \mathcal{C}})$ consisting of an object $X \in \mathcal{C}$ and natural isomorphisms

$$\gamma_{X,Y} : X \otimes Y \xrightarrow{\sim} Y \otimes X$$

for all objects $Y \in \mathcal{C}$ that satisfy the same compatibility conditions as braidings found in (1) of Section 2.1; i.e. this definition is imposed so that $Z(\mathcal{C})$ is naturally braided. Where the analogy to the center of a ring falls apart is that in general $Z(\mathcal{C})$ is much *larger* than \mathcal{C} as the same object $X \in \mathcal{C}$ may have many distinct collections of braidings $\{\gamma_{X,Y}\}_{Y \in \mathcal{C}}$ which can be paired with it. If \mathcal{C} is a braided fusion category, the functors $\mathcal{C}, \mathcal{C}^{\text{rev}} \rightarrow Z(\mathcal{C})$ mapping objects X to themselves paired with their inherent braiding isomorphisms in $\mathcal{C}, \mathcal{C}^{\text{rev}}$ are fully faithful and their images centralize one another, giving a braided tensor functor

$$\mathcal{C} \boxtimes \mathcal{C}^{\text{rev}} \rightarrow Z(\mathcal{C}) \tag{2}$$

which has been shown to be an isomorphism if and only if \mathcal{C} is modular [14, Proposition 3.7][31, Theorem 7.10].

It is not obvious whether a given nondegenerate braided fusion category arises as the Drinfeld center of another. The Witt group of nondegenerate braided fusion categories can be seen as a device for organizing nondegenerate braided fusion categories by equating those that differ only by the Drinfeld center of another.

Definition 9. The *Witt group of nondegenerate braided fusion categories* (hereby called *the Witt group*, or simply \mathcal{W}) is the set of equivalence classes of nondegenerate braided fusion categories $[\mathcal{C}]$ where $[\mathcal{C}] = [\mathcal{D}]$ if there exist fusion categories \mathcal{A}_1 and \mathcal{A}_2 such that $\mathcal{C} \boxtimes Z(\mathcal{A}_1) \simeq \mathcal{D} \boxtimes Z(\mathcal{A}_2)$ as braided fusion categories.

The title *group* is justified as the Deligne tensor product equips \mathcal{W} with a commutative monoidal structure (with unit $[\text{Vec}]$) while (2) implies that $[\mathcal{C}]^{-1} = [\mathcal{C}^{\text{rev}}]$ [10, Lemma 5.3].

Completely anisotropic categories (Definition 8) play a special role in the study of \mathcal{W} . As noted in Theorem 5.13 of [10] each Witt equivalence class in \mathcal{W} contains a completely anisotropic category that is unique up to braided equivalence. To produce such a representative one can locate a maximal connected étale algebra $A \in \mathcal{C}$ and the passage to the category of dyslectic A -modules \mathcal{C}_A^0 does not change the Witt equivalency class, i.e. $[\mathcal{C}_A^0] = [\mathcal{C}]$ [10, Proposition 5.4].

One impetus to understanding the structure of \mathcal{W} is that the decomposition of a nondegenerate braided fusion category given in Proposition 1 is not unique in general. The extent of this lack of uniqueness is illustrated in Section 4.2 of [32].

The last tool needed in this section is a numerical invariant that will allow us to quickly prove that Witt equivalence classes of categories are distinct. Assume for the rest of this section that \mathcal{C} is a modular tensor category over \mathbb{C} (Definition 5).

Recall the *multiplicative central charge* $\xi(\mathcal{C}) \in \mathbb{C}$ [17, Section 8.15] which satisfies the following important properties.

Lemma 1. *For any modular tensor categories \mathcal{C} , \mathcal{C}_1 and \mathcal{C}_2*

- (a) $\xi(\mathcal{C})$ is a root of unity,
- (b) $\xi(\mathcal{C}_1 \boxtimes \mathcal{C}_2) = \xi(\mathcal{C}_1)\xi(\mathcal{C}_2)$, and
- (c) $\xi(\mathcal{C}^{\text{rev}}) = \xi(\mathcal{C})^{-1}$.

The equivalence in (2) along with Lemma 1 (b),(c) imply that $\xi(Z(\mathcal{C})) = 1$. Lemma 5.27 of [10] proves further that for pseudo-unitary modular tensor categories, multiplicative central charge is a numerical invariant of Witt equivalency classes. This allows us to predict the possible order of elements in \mathcal{W}_{un} .

CHAPTER III

QUANTUM GROUPS TO MODULAR TENSOR CATEGORIES

Chapter III includes overlapping portions of [41] (the final publication is available at Springer via <http://dx.doi.org/10.1007/s00220-017-2831-z>) and [42].

If \mathfrak{g} is a finite-dimensional simple Lie algebra and $\hat{\mathfrak{g}}$ is the corresponding affine Lie algebra, then for all $k \in \mathbb{Z}_{>0}$ one can associate a pseudo-unitary modular tensor category $\mathcal{C}(\mathfrak{g}, k)$ consisting of highest weight integrable $\hat{\mathfrak{g}}$ -modules of level k . These categories were studied by Andersen and Paradowski [1] and Finkelberg [18] later proved that $\mathcal{C}(\mathfrak{g}, k)$ is equivalent to the semisimple portion of the representation category of Lusztig's quantum group $\mathcal{U}_q(\mathfrak{g})$ when $q = e^{\pi i/(k+h^\vee)}$ (Figure 1.) where h^\vee is the dual coxeter number for \mathfrak{g} [3, Chapter 7].

\mathfrak{g}	q
\mathfrak{sl}_2	$\exp(\pi i/(k+2))$
\mathfrak{sl}_3	$\exp(\pi i/(k+3))$
\mathfrak{so}_5	$\exp((1/2)\pi i/(k+3))$
\mathfrak{g}_2	$\exp((1/3)\pi i/(k+4))$

Figure 1.: Roots of unity q when $\text{rank}(\mathfrak{g}) \leq 2$

Let \mathfrak{h} be a Cartan subalgebra of \mathfrak{g} and $\langle \cdot, \cdot \rangle$ be the invariant form on \mathfrak{h}^* normalized so that $\langle \alpha, \alpha \rangle = 2$ for short roots [25, Section 5]. Simple objects of $\mathcal{C}(\mathfrak{g}, k)$ are labelled by weights $\lambda \in \Lambda_0 \subset \mathfrak{h}^*$, the *Weyl alcove* of \mathfrak{g} at level k . Simple objects and their representative weights will be used interchangeably but can be easily determined by context. Geometrically, Λ_0 can be described as those weights bounded by the *walls* of Λ_0 : the hyperplanes $T_i := \{\lambda \in \mathfrak{h}^* : \langle \lambda + \rho, \alpha_i \rangle = 0\}$ for each simple root $\alpha_i \in \mathfrak{h}^*$ and $T_0 := \{\lambda \in \mathfrak{h}^* : \langle \lambda + \rho, \theta^\vee \rangle < k + h^\vee\}$ where θ is the longest dominant root. Reflections through the hyperplane T_i will be denoted τ_i which generate the *affine Weyl group* \mathfrak{W}_0 .

If ρ is the half-sum of all positive roots of \mathfrak{g} then the dimension of the simple object corresponding to the weight $\lambda \in \Lambda_0$ is given by the *quantum Weyl dimension formula*

$$\dim(\lambda) = \prod_{\alpha > 0} \frac{[\langle \alpha, \lambda + \rho \rangle]}{[\langle \alpha, \rho \rangle]}$$

where $[m]$ is the *q-analog* of $m \in \mathbb{Z}_{\geq 0}$ which for a generic parameter q is

$$[m] = \frac{q^m - q^{-m}}{q - q^{-1}} = q^{m-1} + q^{m-3} + \dots + q^{-(m-3)} + q^{-(m-1)}.$$

Using elementary trigonometry, quantum analogs can be expressed solely in terms of sines or cosines. The argument of q^m is $m\pi/\varepsilon(\mathfrak{g}, k)$ as illustrated in Figure 2. which implies

$$|[m]| = \left| \frac{q^m - q^{-m}}{q - q^{-1}} \right| = \frac{\sin\left(\frac{m\pi}{\varepsilon(\mathfrak{g}, k)}\right)}{\sin\left(\frac{\pi}{\varepsilon(\mathfrak{g}, k)}\right)}.$$

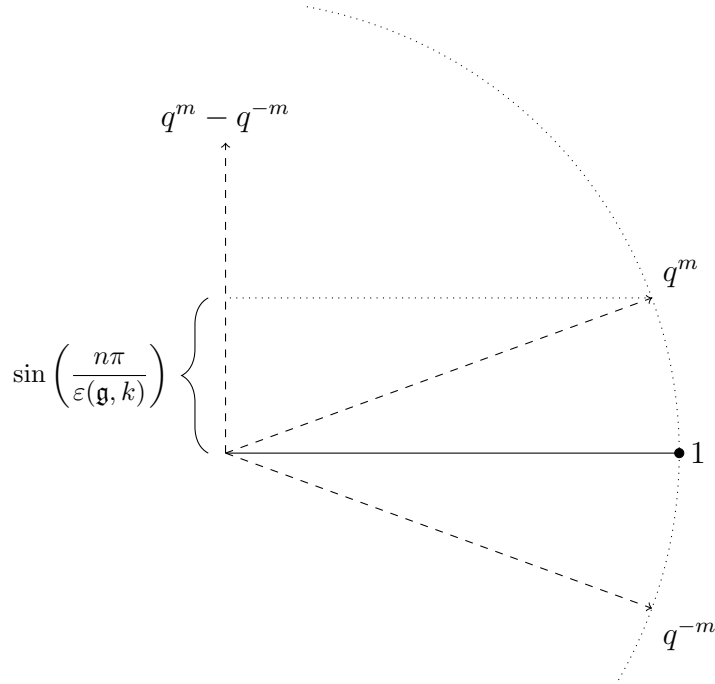

Figure 2.: Modulus of $q^m - q^{-m}$

In what follows the numerator of the quantum Weyl dimension formula will often be all that needs to be considered as only equalities and inequalities of

dimensions with equal denominators appear. We will denote this numerator $\dim'(\lambda)$. With the values of q found in Figure 1., $\dim(\lambda) \in \mathbb{R}_{\geq 1}$ (and in particular $[m] \in \mathbb{R}_{>0}$ for all considered $m \in \mathbb{Z}_{>0}$) for all $\lambda \in \Lambda_0$. The full twist on a simple object $\lambda \in \Lambda_0$ is given by $\theta(\lambda) = q^{(\lambda, \lambda + 2\rho)}$ which is a root of unity depending on \mathfrak{g} , k , and λ .

We refer the reader to [25, Sections 13,21–24] for concepts and results from classical representation theory of Lie algebras.

3.1. Numerical Data and Fusion Rules for $\mathcal{C}(\mathfrak{g}, k)$ when $\text{rank}(\mathfrak{g}) \leq 2$

Simple objects of $\mathcal{C}(\mathfrak{sl}_2, k)$ are enumerated by $s \in \mathbb{Z}_{\geq 0}$ such that $s \leq k$. Each object, denoted by (s) , corresponds to the weight $s\lambda \in \Lambda_0$, where λ is the unique fundamental weight. The dimension of (s) is given by $\dim(s) = [s + 1]$ and the full twist on this object by

$$\theta(s) = \exp\left(\frac{s(s+2)}{4(k+2)} \cdot 2\pi i\right).$$

Figures 3.–6. contain geometric visualizations of the Weyl alcove with respect to the specified Lie algebra and level, with nodes representing weights in Λ_0 and shaded nodes representing those weights which also lie in the root lattice. Walls of Λ_0 are illustrated by dashed lines.

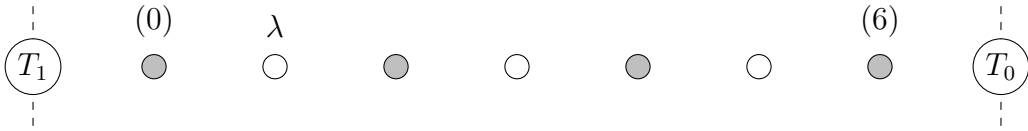

Figure 3.: $\mathcal{C}(\mathfrak{sl}_2, 6)$

Simple objects of $\mathcal{C}(\mathfrak{sl}_3, k)$ are enumerated by nonnegative integer pairs (s, t) , such that $s + t \leq k$. Each (s, t) corresponds to the weight $s\lambda_1 + t\lambda_2 \in \Lambda_0$. The dimension of the simple object (s, t) is given by

$$\dim(s, t) = \frac{1}{[2]}[s + 1][t + 1][s + t + 2],$$

and using the trigonometric identities for quantum analogs, we have the following proposition which will refer back to in future proofs.

Proposition 2. For all $(s, t) \in \Lambda_0$

$$\dim(s, t) = \frac{\sin\left(\frac{(s+1)\pi}{k+3}\right) \sin\left(\frac{(t+1)\pi}{k+3}\right) \sin\left(\frac{(s+t+2)\pi}{k+3}\right)}{\sin\left(\frac{2\pi}{k+3}\right) \sin^2\left(\frac{\pi}{k+3}\right)}.$$

The twist on this object is given by

$$\theta(s, t) = \exp\left(\frac{s^2 + 3s + st + 3t + t^2}{3(k+3)} \cdot 2\pi i\right).$$

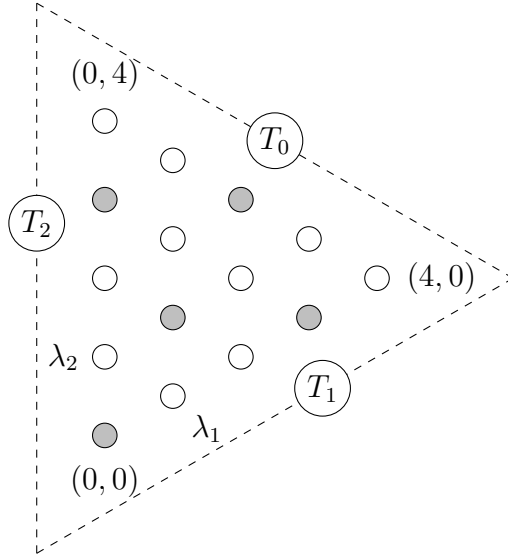

Figure 4.: $\mathcal{C}(\mathfrak{sl}_3, 4)$

Simple objects of $\mathcal{C}(\mathfrak{so}_5, k)$ are enumerated by nonnegative integer pairs (s, t) , such that $s + t \leq k$. Each (s, t) corresponds to the weight $s\lambda_1 + t\lambda_2 \in \Lambda_0$. The dimension of the simple object of $\mathcal{C}(\mathfrak{so}_5, k)$ corresponding to the weight (s, t) is given by

$$\dim(s, t) = \frac{[2(s+1)][t+1][2(s+t+2)][2s+t+3]}{[2][3][4][1]},$$

and the twist on this object by

$$\theta(s, t) = \exp\left(\frac{2s^2 + 2st + 6s + t^2 + 4t}{4(k+3)} \cdot 2\pi i\right).$$

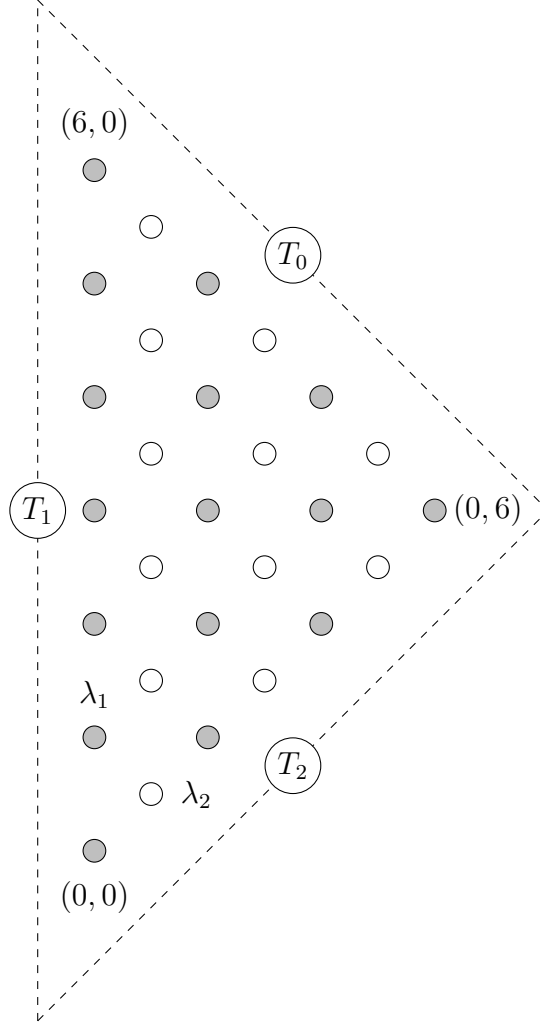

Figure 5.: $\mathcal{C}(\mathfrak{so}_5, 6)$

Simple objects of $\mathcal{C}(\mathfrak{g}_2, k)$ are enumerated by nonnegative integer pairs (s, t) , such that $s + 2t \leq k$. Each (s, t) corresponds to the weight $s\lambda_1 + t\lambda_2 \in \Lambda_0$. The dimension of the simple object (s, t) is given by

$$\dim(s, t) = \frac{[s+1][3(t+1)][3(s+t+2)][3(s+2t+3)][s+3t+4][2s+3t+5]}{[1][3][6][9][4][5]},$$

and the twist on this object by

$$\theta(s, t) = \exp\left(\frac{s^2 + 3st + 5s + 3t^2 + 9t}{3(k+4)} \cdot 2\pi i\right).$$

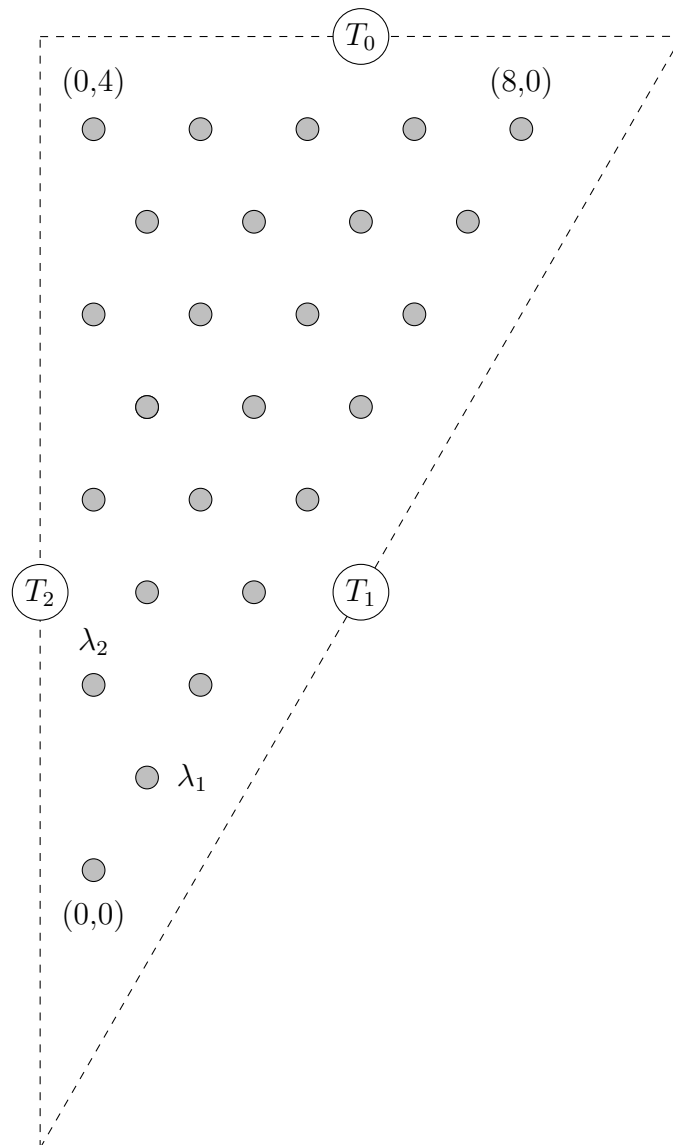

Figure 6.: $\mathcal{C}(\mathfrak{g}_2, 8)$

Lastly we recall a result influenced by Andersen and Paradowski and proven by Sawin as Corollary 8 in [39], giving a formula for the fusion rules in $\mathcal{C}(\mathfrak{g}, k)$.

Proposition 3 (Quantum Racah formula). *If $\lambda, \gamma, \eta \in \Lambda_0$ then*

$N_{\lambda, \gamma}^\eta := \dim_{\mathbb{C}} \text{Hom}(\eta, \lambda \otimes \gamma)$ is given by

$$N_{\lambda, \gamma}^\eta = \sum_{\tau \in \mathfrak{W}_0} (-1)^{\ell(\tau)} m_\gamma(\tau(\eta) - \lambda),$$

where $\ell(\tau)$ is the length of a reduced expression of $\tau \in \mathfrak{W}_0$ in terms of τ_1, τ_2, τ_3 and $m_\lambda(\mu)$ is the dimension of the μ -weight space in the classical representation of highest weight λ .

As in Lemma 1 of [38] this formula can be used to identify particular direct summands of tensor products of simple objects in $\mathcal{C}(\mathfrak{g}, k)$. Based on slight notational discrepancies in the Quantum Racah formula in [38], we provide a proof here based on that of Sawin's.

Lemma 2 (Sawin). *For any σ in the classical Weyl group \mathfrak{W} , and any $\gamma, \lambda \in \Lambda_0$, if $\lambda + \sigma(\gamma) \in \Lambda_0$, then $\lambda \otimes \gamma$ contains $\lambda + \sigma(\gamma)$ as a direct summand with multiplicity one.*

Proof. Assume that $\lambda' \notin \Lambda_0$ is any weight conjugate to $\lambda \in \Lambda_0$ under the action of \mathfrak{W}_0 . Explicitly, there exists $(\tau_{i_1} \tau_{i_2} \cdots \tau_{i_t}) \in \mathfrak{W}_0$ (written as a reduced expression in the generating simple reflections) such that

$$(\tau_{i_1} \tau_{i_2} \cdots \tau_{i_t})(\lambda') = \lambda. \quad (3)$$

Now let $\eta \in \Lambda_0$ be arbitrary. The hyperplane of reflection corresponding to τ_{i_t} lies between λ' and η by assumption, so $\|\tau_{i_t}(\lambda') - \eta\| < \|\lambda' - \eta\|$. Repeating this argument over all simple reflections in (3) shows that

$$\|\lambda - \eta\| < \|\lambda' - \eta\|. \quad (4)$$

With reference to the summands appearing in Proposition 3, assume that

$m_\gamma(\tau(\lambda + \sigma(\gamma)) - \lambda) \neq 0$ for some non-trivial $\tau \in \mathfrak{W}_0$. Then

$$\|\tau(\lambda + \sigma(\gamma)) - \lambda\| \leq \|\gamma\| \quad (5)$$

because γ is highest weight. Since $\lambda + \sigma(\gamma) \in \Lambda_0$ and $\tau(\lambda + \sigma(\gamma))$ is not, (4) implies

$$\|\gamma\| = \|\sigma(\gamma)\| = \|(\lambda + \sigma(\gamma)) - \lambda\| < \|\tau(\lambda + \sigma(\gamma)) - \lambda\|$$

contradicting the highest weight inequality in (5). Thus $m_\gamma(\tau(\lambda + \sigma(\gamma)) - \lambda)$ is possibly nonzero if and only if $\tau = \text{id} \in \mathfrak{W}_0$ and thus

$$N_{\lambda,\gamma}^{\lambda+\sigma(\gamma)} = (-1)^0 m_\gamma((\lambda + \sigma(\gamma)) - \lambda) = m_\gamma(\sigma(\gamma)) = 1.$$

□

It is necessary to the proof of future claims to consider the geometric interpretation of the quantum Racah formula specifically for rank 2 Lie algebras [39, Remark 4]. The notation and concepts introduced in this subsection will be used prolifically throughout the proof of Theorem 5 and are illustrated by example in Figure 7. to compute $N_{\lambda,\gamma}^\mu$ for arbitrary $\mu \in \Lambda_0$, $\lambda := (3, 4)$, and $\gamma := (3, 6)$ (white node) in $\mathcal{C}(\mathfrak{so}_5, 12)$.

Given $\lambda, \gamma \in \Lambda_0$, the quantum Racah formula states that to calculate the fusion coefficients $N_{\lambda,\gamma}^\mu$ for any $\mu \in \Lambda_0$ geometrically, one should compute $\Pi(\lambda)$, the classical weight diagram for the finite-dimensional irreducible representation of highest weight λ , and (for visual ease) we illustrate its convex hull, $\bar{\Pi}(\lambda)$. For this purpose reflections in the classical Weyl group are illustrated in Figure 7.a by thin lines. One can then shift $\bar{\Pi}(\lambda)$ and $\Pi(\lambda)$, so they are centered at γ , denoting these shifted sets by $\bar{\Pi}(\lambda : \gamma)$ and $\Pi(\lambda : \gamma)$. Now for a fixed weight $\mu \in \Lambda_0$, $\tau \in \mathfrak{W}_0$ will contribute to the sum $N_{\lambda,\gamma}^\mu$ if and only if there exists $\mu' \in \Pi(\lambda : \gamma)$ such that $\tau(\mu') = \mu$. The walls of Λ_0 are illustrated (and labelled) in Figure 7.b by dashed lines and all contributing $\tau \in \mathfrak{W}_0$ can be visualized by *folding* $\bar{\Pi}(\lambda : \gamma)$ along the

walls of Λ_0 until it lies completely within Λ_0 . To emphasize effect of folding, the folded portions of $\bar{\Pi}(\lambda : \gamma)$ are illustrated in Figure 7.b with emphasized shading, while regions of $\bar{\Pi}(\lambda : \gamma)$ unaffected by folding are given a crosshatch pattern.

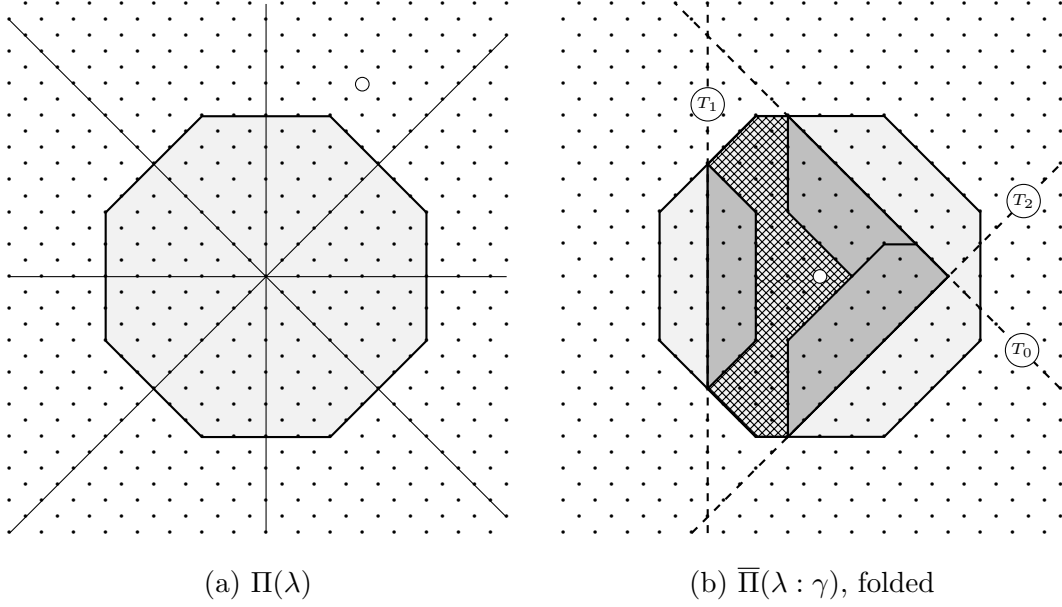

Figure 7.: $\lambda \otimes \gamma \in \mathcal{C}(\mathfrak{so}_5, 12)$

For arbitrary $\lambda, \gamma, \mu \in \Lambda_0$ there may be several $\tau \in \mathfrak{W}_0$ which contribute (positively or negatively) to the sum $N_{\lambda, \gamma}^\mu$ in the quantum Racah formula, but for many fusion coefficients the only contribution comes from the identity of \mathfrak{W}_0 and are therefore easily determined to be zero or positive. In Figure 7.b, these coefficients correspond to weights in $\Pi(\lambda : \gamma)$ which also lie in the crosshatched region.

Lemma 3. Fix $\lambda, \gamma, \mu \in \Lambda_0$. If

(1) $\mu \in \Pi(\lambda : \gamma)$, and

(2) $\tau_i(\mu') \neq \mu$ for any $\mu' \in \Pi(\lambda : \gamma)$ and $i = 0, 1, 2$,

then $N_{\lambda, \gamma}^\mu > 0$.

Proof. By assumption (1), $m_\lambda(\mu - \gamma) > 0$ is one term in the quantum Racah formula for $N_{\lambda, \gamma}^\mu$. Any nontrivial τ contributing to $N_{\lambda, \gamma}^\mu$, does so via $\mu' \in \Pi(\lambda : \gamma)$ conjugate to μ . But one can verify using elementary plane geometry that

$\tau_i(\overline{\Pi}(\lambda : \gamma)) \subset \overline{\Pi}(\lambda : \gamma)$ for each generating reflection $i = 0, 1, 2$. This observation along with assumption (2) implies no reflections of length greater than or equal to one may contribute to the desired fusion coefficient and moreover $N_{\lambda, \gamma}^{\mu}$ is equal to $m_{\lambda}(\mu - \gamma) > 0$. \square

3.2. $\mathcal{C}(\mathfrak{sl}_3, k)$

Even though the duality in $\mathcal{C}(\mathfrak{sl}_3, k)$ is clear for other reasons, its computation is straightforward from Lemma 2.

Corollary 1. *If $(m_1, m_2) \in \Lambda_0$, then $(m_1, m_2)^* = (m_2, m_1)$.*

Proof. Note that if \mathcal{C} is a fusion category and $X, Y \in \mathcal{C}$ are simple, then by adjointness of duality $Y^* \simeq X$ if and only if

$$1 = \dim_{\mathbb{k}} \text{Hom}(Y^*, X) = \dim_{\mathbb{k}} \text{Hom}(\mathbf{1}, X \otimes Y).$$

Now if we denote the generating reflections $\sigma_1, \sigma_2 \in \mathfrak{W}$, then

$$(\sigma_2 \sigma_1 \sigma_2)(m_2, m_1) = -(m_1, m_2).$$

Thus $(m_1, m_2) + (\sigma_2 \sigma_1 \sigma_2)(m_2, m_1) = (0, 0)$ and by Lemma 2, $(m_1, m_2) \otimes (m_2, m_1)$ contains $(0, 0)$ with multiplicity one. \square

We also collect a formula for the multiplicative central charge of $\mathcal{C}(\mathfrak{g}, k)$ [10, Section 6.2] for future use.

Lemma 4. *The multiplicative central charge of $\mathcal{C} := \mathcal{C}(\mathfrak{g}, k)$ is given by*

$$\xi(\mathcal{C}) = \exp\left(\frac{2\pi i}{8} \cdot \frac{k \dim \mathfrak{g}}{k + h^{\vee}}\right)$$

where $\dim \mathfrak{g}$ is the dimension of \mathfrak{g} as a \mathbb{C} -vector space and h^{\vee} is the dual Coxeter number of \mathfrak{g} .

Note 4. Refer to the introduction in [39] for a complete list of dual Coxeter numbers.

3.2.1. Fusion Subcategories of $\mathcal{C}(\mathfrak{sl}_3, k)$. All fusion subcategories of $\mathcal{C}(\mathfrak{g}, k)$ were classified by Sawin in Theorem 1 of [38]. For each level $k \in \mathbb{Z}_{>0}$, $\mathcal{C}(\mathfrak{sl}_3, k)$ has four fusion subcategories:

- the trivial fusion subcategory consisting of $(0, 0)$;
- the entire category $\mathcal{C}(\mathfrak{sl}_3, k)$;
- the subcategory consisting of weights $(m_1, m_2) \in \Lambda_0$ also in the root lattice. The collection of such weights will be denoted R_0 ;
- the subcategory consisting of the weights $(0, 0)$, $(k, 0)$, and $(0, k)$, hereby called *corner weights*.

The proof of this classification relies on two facts that will be used in the sequel. We provide proofs here based on the original arguments found in [38], specialized to the case when $\mathfrak{g} = \mathfrak{sl}_3$ for clarity and instructive purposes.

Lemma 5 (Sawin). *If a fusion subcategory $\mathcal{D} \subset \mathcal{C}(\mathfrak{sl}_3, k)$ for $k \geq 2$ contains weight λ that is not a corner weight then $\lambda \otimes \lambda^*$ contains θ as a direct summand.*

Proof. Note that θ is self-dual by Corollary 1, hence $N_{\lambda, \lambda^*}^\theta = N_{\lambda, \theta}^\lambda$ and by Proposition 3

$$N_{\lambda, \theta}^\lambda = \sum_{\tau \in \mathfrak{W}_0} (-1)^{\ell(\tau)} m_\theta(\tau(\lambda) - \lambda). \quad (6)$$

If $\tau = \text{id}$ then the corresponding summand in (6) is $m_\theta(0) = 2$, the rank of \mathfrak{sl}_3 . Now if the simple reflections τ_1, τ_2, τ_3 are the generators of \mathfrak{W}_0 , the reasoning leading to inequality (4) in the proof of Lemma 2 implies if $i \neq j$

$$\|(\tau_i \tau_j)(\lambda) - \lambda\| > \|\tau_j(\lambda) - \lambda\| > 0 \quad (7)$$

for $i, j = 1, 2, 3$. If $\tau_j(\lambda) - \lambda$ contributes to the sum in (6), then $\tau_j(\lambda) - \lambda$ must be a nonzero root. But inequality (7) implies that any $\tau \in \mathfrak{W}_0$ whose reduced

expression in terms of simple reflections has length greater than 1 causes $\tau(\lambda) - \lambda$ to be longer than any root, and hence does not contribute to the sum in (6). Moreover, the only negative contributions to (6) come from simple reflections.

If a weight $\mu \in \Lambda_0$ is adjacent to any generating hyperplane T_i for some $i = 1, 2, 3$ (see Figure 8.), then $\|\tau_i(\mu) - \mu\|^2 \leq 2$ otherwise $\|\tau_i(\mu) - \mu\|^2 > 2$. Thus $\tau_i(\mu) - \mu$ can contribute -1 to the sum in (6) if and only if μ is adjacent to the hyperplane T_i . For $\mu \in \Lambda_0$ which are not corners, the number of adjacent generating hyperplanes adjacent to μ is at most 1, proving $N_{\lambda, \theta}^\lambda > 0$. \square

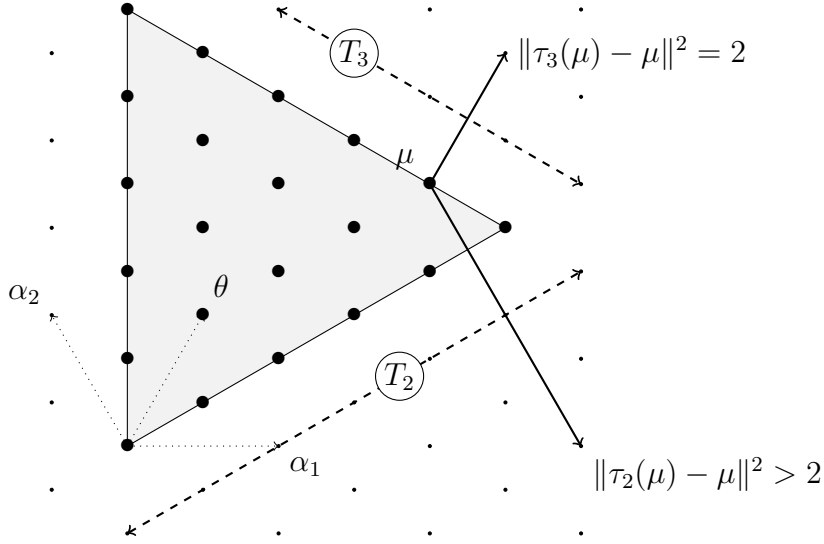

Figure 8.: Adjacent vs. nonadjacent to T_i (level $k = 5$)

Lemma 6 (Sawin). *If a fusion subcategory $\mathcal{D} \subset \mathcal{C}(\mathfrak{sl}_3, k)$ contains weight θ then \mathcal{D} contains the entire root lattice in the Weyl alcove, R_0 .*

Proof. If $\lambda \in R_0$ then there exists a path of length $n \in \mathbb{Z}_{\geq 0}$ of weights $\theta = \lambda_0, \lambda_1, \lambda_2, \dots, \lambda_n = \lambda$ in Λ_0 such that $\lambda_{i+1} - \lambda_i$ is a root for $0 \leq i \leq n - 1$. We now proceed inductively on i to show each λ_i is in \mathcal{D} . Assume λ_i is in \mathcal{D} for some $0 \leq i \leq n - 1$. The Weyl group \mathfrak{W} acts transitively on the roots, so there exists $\sigma_i \in \mathfrak{W}$ such that $\sigma_i(\lambda_0) = \lambda_{i+1} - \lambda_i$. In other words $\lambda_i + \sigma_i(\lambda_0) = \lambda_{i+1} \in \Lambda_0$ and $\lambda_0 \otimes \lambda_i$ contains λ_{i+1} as a direct summand with multiplicity 1 by Lemma 2. \square

3.2.2. Prime Decomposition when $3 \nmid k$. In light of Proposition 1 the categories $\mathcal{C}(\mathfrak{sl}_3, k)$ can be decomposed into a product of prime factors which we will use in the sequel when $3 \nmid k$.

Proposition 4. *The following are decompositions of $\mathcal{C}(\mathfrak{sl}_3, k)$ into prime factors when $3 \nmid k$:*

$$(a) \mathcal{C}(\mathfrak{sl}_3, 1) \simeq \mathcal{C}(\mathbb{Z}/3\mathbb{Z}, q_\omega),$$

$$(b) \mathcal{C}(\mathfrak{sl}_3, 2) \simeq \mathcal{C}(\mathfrak{sl}_3, 2)'_{pt} \boxtimes \mathcal{C}(\mathfrak{sl}_3, 2)_{pt} \simeq (\mathcal{C}(\mathfrak{sl}_2, 3)'_{pt})^{rev} \boxtimes \mathcal{C}(\mathbb{Z}/3\mathbb{Z}, q_{\omega^2}),$$

and for all $m \in \mathbb{Z}_{>0}$

$$(c) \mathcal{C}(\mathfrak{sl}_3, 3m + 1) \simeq \mathcal{C}(\mathfrak{sl}_3, 3m + 1)'_{pt} \boxtimes \mathcal{C}(\mathfrak{sl}_3, 1), \text{ and}$$

$$(d) \mathcal{C}(\mathfrak{sl}_3, 3m + 2) \simeq \mathcal{C}(\mathfrak{sl}_3, 3m + 2)'_{pt} \boxtimes \mathcal{C}(\mathfrak{sl}_3, 2)_{pt}.$$

Note 5. Refer to Example 2 for the definitions of q_ω and q_{ω^2} .

Proof. We begin by computing the twists (Section 3.1.) of the corner weights:

$$\theta(0, k) = \theta(k, 0) = \exp\left(\frac{0^2 + 3(0) + (0)(k) + 3k + k^2}{3(k+3)} \cdot 2\pi i\right) = \exp(2k\pi i/3).$$

Thus if $k \equiv 1 \pmod{3}$ $\theta(0, k) = \theta(k, 0) = \omega$ and if $k \equiv 2 \pmod{3}$ then $\theta(0, k) = \theta(k, 0) = \omega^2$.

The category $\mathcal{C}(\mathfrak{sl}_3, 1)$ is pointed with three simple objects, and so it is determined by its twists found above. This identifies $\mathcal{C}(\mathfrak{sl}_3, 1) \simeq \mathcal{C}(\mathbb{Z}/3\mathbb{Z}, q_\omega)$ which is simple, proving (a).

For level $k = 2$ we first apply Müger's decomposition (Section 2.1.) and notice that $\mathcal{C}(\mathfrak{sl}_3, 2)_{pt} \simeq \mathcal{C}(\mathbb{Z}/3\mathbb{Z}, q_{\omega^2})$ based on the twist computations above. Its centralizer has two simple objects and is not pointed. Thus $\mathcal{C}(\mathfrak{sl}_3, 2)'_{pt}$ is either equivalent to $\mathcal{C}(\mathfrak{sl}_2, 3)'_{pt}$ or $(\mathcal{C}(\mathfrak{sl}_2, 3)'_{pt})^{rev}$ [10, Section 6.4][33]. Using the formula found in Section 6.4 (2) of [10] we see

$$\xi(\mathcal{C}(\mathfrak{sl}_2, 3)'_{pt}) = \exp\left(\frac{2\pi i}{8} \left(\frac{3 \cdot 3}{3+2} + (-1)^{(3+1)/2}\right)\right) = \exp(7\pi i/10),$$

and thus by Lemma 1 (c),

$$\xi((\mathcal{C}(\mathfrak{sl}_2, 3)'_{\text{pt}})^{\text{rev}}) = \exp(13\pi i/10).$$

Using Lemma 1 (b) we have

$$\xi(\mathcal{C}(\mathfrak{sl}_3, 2)'_{\text{pt}}) = \frac{\xi(\mathcal{C}(\mathfrak{sl}_3, 2))}{\xi(\mathcal{C}(\mathfrak{sl}_3, 2)_{\text{pt}})} = \frac{\exp(4\pi i/5)}{\exp(3\pi i/2)} = \exp(13\pi i/10),$$

proving (b) since both of these categories are known to be simple.

The decompositions in parts (c) and (d) follow directly from Müger's decomposition along with parts (a) and (b), and we are left with proving simplicity of the centralizers of the pointed subcategories. For any $k \in \mathbb{Z}_{>0}$ the fusion subcategory of corner weights $((0, 0), (k, 0), \text{ and } (0, k))$ is pointed. Proposition 3 gives

$$\begin{aligned} (0, k) \otimes (m_1, m_2) &= (m_2, k - m_1 - m_2) \quad \text{and} \\ (k, 0) \otimes (m_1, m_2) &= (k - m_1 - m_2, m_1). \end{aligned} \tag{8}$$

Thus using the *balancing equation* [17, Proposition 8.13.8] we have

$$\begin{aligned} s_{(0,k),(m_1,m_2)} &= \exp\left(\frac{1}{3}(k - 2m_1 - m_2) \cdot 2\pi i\right) \dim(m_1, m_2), \quad \text{and} \\ s_{(k,0),(m_1,m_2)} &= \exp\left(\frac{1}{3}(k - m_1 - 2m_2) \cdot 2\pi i\right) \dim(m_1, m_2). \end{aligned}$$

This implies $s_{(0,k),(m_1,m_2)} = s_{(k,0),(m_1,m_2)} = \dim(m_1, m_2)$ if and only if $m_1 \equiv m_2 \pmod{3}$, that is to say $(m_1, m_2) \in R_0$. And from [32, Proposition 2.5] $s_{X,Y} = \dim(X)\dim(Y)$ if and only if X and Y centralize one another. Moreover if $3 \nmid k$ then the corners $(0, k)$ and $(k, 0)$ are not in the root lattice so by Sawin's classification of fusion subcategories (Section 3.2.1.), the centralizers of the pointed subcategories are simple and thus prime. □

We now take a moment to compute the central charge of $\mathcal{C}(\mathfrak{sl}_3, k)'_{\text{pt}}$ for future

use when $k = 3m + 1$ or $k = 3m + 2$ with $m \in \mathbb{Z}_{\geq 0}$ based on (c), (d) of Proposition 4 and the multiplicativity of ξ .

Corollary 2. For $m \in \mathbb{Z}_{\geq 0}$

(a) when $k = 3m + 1$ ($m \neq 0$)

$$\xi(\mathcal{C}(\mathfrak{sl}_3, k)'_{pt}) = \exp\left(\frac{9m}{6m+8}\pi i\right),$$

(b) and when $k = 3m + 2$

$$\xi(\mathcal{C}(\mathfrak{sl}_3, k)'_{pt}) = \exp\left(\frac{3m-7}{6m+10}\pi i\right).$$

3.2.3. Simplicity of $\mathcal{C}(\mathfrak{sl}_3, k)_A^0$ when $3 \mid k$. When $k = 3m$ for some $m \in \mathbb{Z}_{>0}$, the object $A = (0, 0) \oplus (3m, 0) \oplus (0, 3m)$ has the structure of a connected étale algebra and we can consider the nondegenerate braided fusion category consisting of dyslectic A -modules $\mathcal{C}_A^0 := \mathcal{C}(\mathfrak{sl}_3, 3m)_A^0$ (Section 2.3.). The act of tensoring with $(3m, 0)$ or $(0, 3m)$ geometrically results in a rotation of Λ_0 by 120 degrees counter-clockwise or clockwise, respectively, as illustrated in Figure 9..

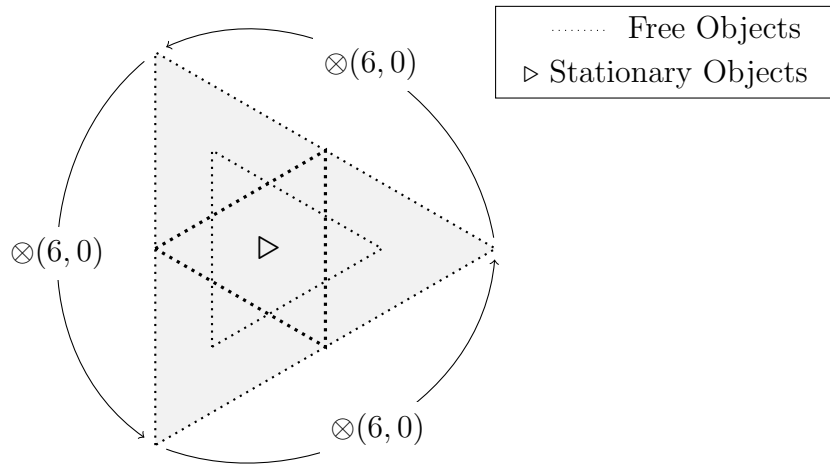

Figure 9.: \mathcal{C}_A^0 at level $k = 6$ and the action of a corner weight

There are two types of simple objects in \mathcal{C}_A^0 :

- *Free* objects (Section 2.3.) are of the form $F(\lambda) = \lambda \otimes A$ for $\lambda \in R_0$ not equal to (m, m) . These objects are the sum of the objects in orbits of size three under the 120 degree rotations described above.
- Three *stationary* objects are isomorphic to (m, m) as objects of $\mathcal{C}(\mathfrak{sl}_3, 3m)$, but non-isomorphic as A -modules. If $\rho_1 : (m, m) \otimes A \rightarrow (m, m)$ is the action on one of these A -modules then the others have actions given by $\rho_\omega = \omega\rho_1$ and $\rho_{\omega^2} = \omega^2\rho_1$ where $\omega = \exp(2\pi i/3)$.

Denote any of these three stationary objects as $X \in \mathcal{C}_A^0$ or collectively as $X_1, X_2, X_3 \in \mathcal{C}_A^0$. At no point in what follows will it become important to distinguish their A -module structures and in fact doing so can lead to ambiguity in computations as illustrated in the \mathfrak{sl}_2 case described in Section 7 of [27].

Example 4. When $k = 3$ the only free object is the identity $F(0, 0)$ and there are three stationary objects X_1, X_2, X_3 corresponding to the central weight $(1, 1)$. This category is pointed by Theorem 1.18 of [27] which states that for $i = 1, 2, 3$

$$\dim(X_i) = \frac{\dim(1, 1)}{\dim(A)} = \frac{\sin^2\left(\frac{\pi}{3}\right) \sin\left(\frac{2\pi}{3}\right)}{3 \sin\left(\frac{\pi}{3}\right) \sin^2\left(\frac{\pi}{6}\right)} = 1. \quad (9)$$

The simple objects of \mathcal{C}_A^0 form an abelian group of order four, which is either cyclic or the Klein-4 group. But the automorphism of this group given by tensoring with $(0, 3)$ or $(3, 0)$ has order three so we must have $\mathcal{C}_A^0 \simeq \mathcal{C}(\mathbb{Z}/2 \oplus \mathbb{Z}/2\mathbb{Z}, q)$ with quadratic form $q : \mathbb{Z}/2\mathbb{Z} \oplus \mathbb{Z}/2\mathbb{Z} \rightarrow \mathbb{C}^\times$ which is 1 on the unit object and -1 on the stationary objects. This category is evidently not simple as $\mathbb{Z}/2\mathbb{Z} \oplus \mathbb{Z}/2\mathbb{Z}$ has many subgroups.

Example 5. We will also examine the case $k = 6$ as it is of great interest. There are three stationary objects $X_1, X_2,$ and X_3 , and three free objects $Y_1 = F(0, 0)$, $Y_2 = F(1, 1)$, and $Y_3 = F(3, 3)$. The tensor structure of the free module functor

gives the fusion rules between the free objects:

$$Y_2 \otimes_A Y_2 = Y_1 \oplus 2Y_2 \oplus 2Y_3 \oplus X_1 \oplus X_2 \oplus X_3,$$

$$Y_2 \otimes_A Y_3 = 2Y_2 \oplus Y_3 \oplus X_1 \oplus X_2 \oplus X_3, \text{ and}$$

$$Y_3 \otimes_A Y_3 = Y_1 \oplus Y_2 \oplus Y_3 \oplus X_1 \oplus X_2 \oplus X_3.$$

For instance

$$\begin{aligned} Y_2 \otimes_A Y_2 &= F(1, 1) \otimes_A F(1, 1) \\ &= F((1, 1) \otimes (1, 1)) \\ &= F((0, 0) \oplus (0, 3) \oplus (3, 0) \oplus (1, 1) \oplus (1, 1) \oplus (2, 2)) \\ &= Y_1 \oplus Y_3 \oplus Y_3 \oplus Y_2 \oplus Y_2 \oplus F(2, 2) \\ &= Y_1 \oplus 2Y_2 \oplus 2Y_3 \oplus X_1 \oplus X_2 \oplus X_3. \end{aligned}$$

Now to compute the remaining fusion rules note that at least one X_i is self dual, hence all objects in the orbit of this X_i (under tensoring with a corner object) must be self dual as well; i.e. all stationary objects X_i are self dual.

By comparing dimensions we must have that

$$Y_2 \otimes_A X_i = Y_2 \oplus Y_3 \oplus X_j \oplus X_k, \tag{10}$$

$$Y_3 \otimes_A X_i = Y_2 \oplus Y_3 \oplus X_\ell, \tag{11}$$

and

$$X_r \otimes_A X_s = \begin{cases} Y_1 \oplus Y_3 \oplus X_t & \text{if } r = s \\ Y_2 \oplus X_u & \text{if } r \neq s \end{cases} \tag{12}$$

for some $j, k, \ell, t, u = 1, 2, 3$. We will now determine the unknown summands in (10), (11), and (12). For instance the self duality of all objects implies if $i \neq j$, by

(12) we must have

$$1 = \dim_{\mathbb{C}} \text{Hom}(Y_2, X_i \otimes_A X_j) = \dim_{\mathbb{C}} \text{Hom}(X_i, Y_2 \otimes_A X_j).$$

Hence i, j, k are all distinct in (10). Similarly

$$0 = \dim_{\mathbb{C}} \text{Hom}(Y_3, X_i \otimes_A X_j) = \dim_{\mathbb{C}} \text{Hom}(X_i, Y_3 \otimes_A X_j),$$

which implies $i = \ell$ in (11) above. For any $i, j = 1, 2, 3$ denote the unknown summand in $X_i \otimes_A X_j$ by $X_{i,j}$. We will show that if $X_i \neq X_{i,i}$ then the following equality cannot hold:

$$3 = \dim_{\mathbb{C}} \text{Hom}(X_i \otimes_A X_i, X_i \otimes_A X_i) = \dim_{\mathbb{C}} \text{Hom}(Y_1, X_i^{\otimes A 4}). \quad (13)$$

To see the contradiction note that $X_{i,i}^{\otimes A 3} = 2Y_2 \oplus Y_3 \oplus 2X_i \oplus X_{i,ii}$ where $X_{i,ii}$ is the unknown summand in the product $X_i \otimes_A X_{i,i}$. Our initial assumption and the self duality of X_i guarantees $X_i \neq X_{i,i}^*$ and thus $X_i \neq X_{i,ii}$. But this would imply $\dim_{\mathbb{C}} \text{Hom}(X_i \otimes_A X_i, X_i \otimes_A X_i) = 2$ by the above computation of $X_i^{\otimes A 3}$, contradicting (13).

Now to determine the remaining fusion rule in (12), computing $Y_2 \otimes (X_i \otimes X_i)$ and $(Y_2 \otimes X_i) \otimes X_i$ using (10), (11), and the first part of (12) shows that $X_{i,i} = X_i$, $X_{i,j}$ and $X_{j,k}$ are distinct. By symmetry of this computation $X_{j,i}$, $X_{j,j} = X_j$, and $X_{j,k}$ as well as $X_{k,i}$, $X_{k,j}$, and $X_{k,k} = X_k$ are distinct triples as well. This proves that $X_i \otimes X_j = Y_2 \oplus X_k$ where i, j, k are distinct and the fusion rules are completely determined.

Note 6. $\mathcal{C}(\mathfrak{sl}_3, 6)_A^0$ is simple.

The S -matrix is now computed using the *balancing equation* [17, Proposition 8.13.8] which states that for all $X, Y \in \mathcal{O}(\mathcal{C})$ in a pre-modular category \mathcal{C} ,

$$s_{X,Y} = \theta(X)^{-1} \theta(Y)^{-1} \sum_{Z \in \mathcal{O}(\mathcal{C})} N_{X,Y}^Z \theta(Z) \dim(Z).$$

The ribbon structure of $\mathcal{C}(\mathfrak{sl}_3, 6)_A^0$ is identical to that of $\mathcal{C}(\mathfrak{sl}_3, 6)$ by Theorem 1.17 of [27] and the dimensions are computed using Theorem 1.18 of [27] as in Example 4 to yield

$$S = \begin{bmatrix} 1 & \zeta + 1 & \zeta & \epsilon & \epsilon & \epsilon \\ \zeta + 1 & \zeta & -1 & -\epsilon & -\epsilon & -\epsilon \\ \zeta & -1 & -(\zeta + 1) & \epsilon & \epsilon & \epsilon \\ \epsilon & -\epsilon & \epsilon & 2\epsilon & -\epsilon & -\epsilon \\ \epsilon & -\epsilon & \epsilon & -\epsilon & 2\epsilon & -\epsilon \\ \epsilon & -\epsilon & \epsilon & -\epsilon & -\epsilon & 2\epsilon \end{bmatrix},$$

where ζ is the positive root of $x^3 - 3x^2 - 6x - 1$ and ϵ is the greatest positive root of $x^3 - 3x^2 + 1$. The T -matrix for \mathcal{C}_A^0 contains the same twists as the corresponding objects in $\mathcal{C}(\mathfrak{sl}_3, 6)$: $T = \text{diag}(1, \omega, \omega^2, \eta, \eta, \eta)$ where $\omega = \exp(2\pi i/3)$ and $\eta = \exp(2\pi i/9)$.

Note 7. This S -matrix was computed independently for the author by Daniel Creamer applying algebro-geometric methods to the admissability criterion found for example in [6] under the assumption that this category was self dual.

Theorem 1. *The categories $\mathcal{C}_A^0 := \mathcal{C}(\mathfrak{sl}_3, 3m)_A^0$ are simple for $m \geq 2$.*

Proof. Assume that $\mathcal{D} \subset \mathcal{C}_A^0$ is a fusion subcategory containing a non-trivial simple free object $F(\lambda)$ for some $\lambda \in R_0$. As noted in Section 2.1. the fusion subcategory \mathcal{D} must also contain $F(\lambda)^*$. Lemma 5 implies $\lambda \otimes \lambda^*$ contains θ as a summand. So by the tensor structure of F (Section 2.3.),

$$F(\lambda) \otimes_A F(\lambda)^* = F(\lambda) \otimes_A F(\lambda^*) = F(\lambda \otimes \lambda^*)$$

which implies $F(\lambda) \otimes_A F(\lambda)^*$ contains $F(\theta)$ as a summand. Finally Lemma 6 implies that there exists an $n \in \mathbb{Z}_{>0}$ such that θ^n contains μ as a direct summand for any $\mu \in R_0$. Hence by the above argument using the tensor structure of F ,

$F(\theta)^n$ will contain $F(\mu)$ as a direct summand. In this case we have proven $\mathcal{D} = \mathcal{C}_A^0$ since all simple objects are direct summands of free objects (Section 2.3.).

The only case that remains is if the fusion subcategory \mathcal{D} only contains stationary object(s) $X \in \mathcal{C}_A^0$ corresponding to the central weight (m, m) which we will denote as ν for brevity.

Lemma 7. *In $\mathcal{C}(\mathfrak{sl}_3, 3m)$ with $m \in \mathbb{Z}_{>0}$, we have $N_{\nu, \nu}^\nu = m + 1$.*

Proof. Proposition 3 gives

$$N_{\nu, \nu}^\nu = \sum_{\tau \in \mathfrak{W}_0} (-1)^\tau m_\nu(\tau(\nu) - \nu). \quad (14)$$

For the simple reflections $\tau_1, \tau_2, \tau_3 \in \mathfrak{W}_0$, $\|\tau_i(\nu) - \nu\| > \|\nu\|$ and by the reasoning leading to inequality (4) in the proof of Lemma 2 the only nonzero term in (14) comes from the identity in \mathfrak{W}_0 , i.e. $N_{\nu, \nu}^\nu = m_\nu(0)$. If $p(\mu)$ is the number of ways of writing a weight μ as a sum of positive roots, by Kostant's multiplicity formula [25, Chapter 24.2]

$$\begin{aligned} m_\nu(0) &= \sum_{\sigma \in \mathfrak{W}} (-1)^{\ell(\sigma)} p(\sigma((m+1)\alpha_1 + (m+1)\alpha_2) - \alpha_1 - \alpha_2) \\ &= p(m\alpha_1 + m\alpha_2) \end{aligned}$$

because the argument of p is not dominant for any nontrivial elements of the Weyl group. Now it suffices to note that because there are three positive roots, $\alpha_1, \alpha_2, \alpha_1 + \alpha_2$, then $p(m\alpha_1 + m\alpha_2) = m + 1$ because to count the number of ways to write $m\alpha_1 + m\alpha_2$ as a sum of positive roots is the same as choosing how many copies of $\alpha_1 + \alpha_2$ to use (the number of α_1 's and α_2 's are then determined). \square

To finish the proof of Theorem 1, we wish to show that some nontrivial simple free object appears as a summand of $X \otimes_A X$ ($\mathbf{1}$ is a summand of $X \otimes_A X^*$ as $\dim_{\mathbb{C}} \text{Hom}(\mathbf{1}, X \otimes_A X^*) = \dim_{\mathbb{C}} \text{Hom}(X, X) = 1$). We have already shown above that this would imply the nontrivial simple free summand generates the entire

category \mathcal{C}_A^0 .

If $X \otimes_A X^*$ does *not* contain a simple non-trivial summand different from X then we must have

$$X \otimes_A X^* = \mathbf{1} \oplus nX$$

where $n \in \mathbb{Z}_{\geq 0}$ and $n \leq m + 1$ by Lemma 7. Using the additivity and multiplicativity of dimension the above implies

$$\dim(X)^2 - n \dim(X) - 1 = 0,$$

hence

$$\dim(X) = \frac{n + \sqrt{n^2 + 4}}{2} \leq m + 3. \quad (15)$$

By Proposition 2 and Theorem 1.18 of [27],

$$\begin{aligned} \dim(X) &= \frac{\sin^2\left(\frac{(m+1)\pi}{3(m+1)}\right) \sin\left(\frac{(2(m+1)\pi)}{3(m+1)}\right)}{3 \sin\left(\frac{2\pi}{3(m+1)}\right) \sin^2\left(\frac{\pi}{3(m+1)}\right)} \\ &= \frac{\sqrt{3}}{8 \sin\left(\frac{2\pi}{3(m+1)}\right) \sin^2\left(\frac{\pi}{3(m+1)}\right)}. \end{aligned}$$

But for $m \geq 2$ the arguments of the above sines are positive hence $\sin(x) < x$ and we have

$$\dim(X) > \frac{27\sqrt{3}(m+1)^3}{16\pi^3}$$

which is strictly greater than $m + 3$ for $m \geq 3$, contradicting the inequality in (15). The case when $m = 2$ was described explicitly in Example 5. \square

CHAPTER IV

WITT GROUP RELATIONS

Chapter IV appeared in [41] (the final publication is available at Springer via <http://dx.doi.org/10.1007/s00220-017-2831-z>).

4.1. Modular Invariants and Conformal Embeddings

Given a connected étale algebra A in a modular tensor category \mathcal{C} one can construct $Z_A \in \text{Mat}_n(\mathbb{Z}_{\geq 0})$ where $n = |\mathcal{O}(\mathcal{C})|$. The matrix Z_A commutes with the modular group action associated with the modular tensor category \mathcal{C} , i.e. Z_A commutes with the S -matrix and T -matrix of \mathcal{C} [27, Theorem 4.1]. Such matrices have been referred to as (symmetric) *modular invariants* in the mathematical physics literature [22, Definition 1].

Note 8. There is a slight discrepancy in vocabulary needed to use [27, Theorem 4.1] in the case of connected étale algebras in $\mathcal{C}(\mathfrak{g}, k)$. In particular this theorem was proven assuming A is a “rigid \mathcal{C} -algebra with $\theta(A) = \text{id}_A$ ”. The term \mathcal{C} -algebra in [27, Definition 1.1] corresponds to an associative, unital, commutative, connected algebra in \mathcal{C} . Thus connected étale algebras in \mathcal{C} are also \mathcal{C} -algebras. The term rigid [27, Definition 1.11] requires a certain nondegenerate pairing $A \otimes A \rightarrow \mathbf{1}$ which is guaranteed for connected étale algebras as noted in [10, Remark 3.4]. A proof of the fact that $\theta(A) = \text{id}_A$ when A is a connected étale algebra in a *pseudo-unitary* modular tensor category can be derived from paragraph 3 of [36, Remark 2.19], or in Lemma 8.

To explicitly compute Z_A from a connected étale algebra $A \in \mathcal{C}$ one should decompose all dyslectic modules $M \in \mathcal{C}_A^0$ as objects of \mathcal{C} : $M = \bigoplus_{X \in \mathcal{O}(\mathcal{C})} N_M^X X$, with $N_M^X \in \mathbb{Z}_{\geq 0}$ and treating X as a formal symbol representing an object

$X \in \mathcal{O}(\mathcal{C})$, compute

$$\sum_{M \in \mathcal{O}(\mathcal{C}_A^0)} |N_M^X X|^2 = \sum_{X, Y \in \mathcal{O}(\mathcal{C})} Z_{X, Y} X \bar{Y},$$

for some $Z_{X, Y} \in \mathbb{Z}_{\geq 0}$. The coefficient matrix $Z_A := Z_{X, Y}$ is the modular invariant associated to A .

Example 6. For a low-rank example consider $\mathcal{C} := \mathcal{C}(\mathfrak{sl}_2, 4)$ with five simple objects: $(0), (1), (2), (3), (4)$. The object $A := (0) \oplus (4)$ has the structure of a connected étale algebra and \mathcal{C}_A^0 has three simple objects: $(0) \oplus (4)$ and two objects isomorphic to (2) with different A -module structures. We compute

$$\begin{aligned} \sum_{M \in \mathcal{O}(\mathcal{C}_A^0)} |N_M^X X|^2 &= |(0) + (4)|^2 + 2|(2)|^2 \\ &= (0)\overline{(0)} + (0)\overline{(4)} + (4)\overline{(0)} + (4)\overline{(4)} + 2(2)\overline{(2)}, \end{aligned}$$

which yields the following modular invariant. The reader may verify that Z_A commutes with the given S -matrix for $\mathcal{C}(\mathfrak{sl}_2, 4)$.

$$Z_A = \begin{bmatrix} 1 & 0 & 0 & 0 & 1 \\ 0 & 0 & 0 & 0 & 0 \\ 0 & 0 & 2 & 0 & 0 \\ 0 & 0 & 0 & 0 & 0 \\ 1 & 0 & 0 & 0 & 1 \end{bmatrix}$$

$$S = \begin{bmatrix} 1 & \sqrt{3} & 2 & \sqrt{3} & 1 \\ \sqrt{3} & \sqrt{3} & 0 & -\sqrt{3} & -\sqrt{3} \\ 2 & 0 & -2 & 0 & 2 \\ \sqrt{3} & -\sqrt{3} & 0 & \sqrt{3} & -\sqrt{3} \\ 1 & -\sqrt{3} & 2 & -\sqrt{3} & 1 \end{bmatrix}$$

As the rank of \mathfrak{g} and the level k increase without bound across all $\mathcal{C}(\mathfrak{g}, k)$,

computing and classifying these modular invariants from a numerical standpoint becomes an arduous task. A complete and rigorous classification only exists for all levels k in the $\mathfrak{g} = \mathfrak{sl}_2$ [7] and $\mathfrak{g} = \mathfrak{sl}_3$ [22] cases, the latter being of particular interest to our second main result. In particular there is an infinite family of such modular invariants for \mathfrak{sl}_3 occurring at levels $k = 3m$ for some $m \in \mathbb{Z}_{\geq 1}$, arising from the connected étale algebras described in Section 3.2.3. (there is also a trivial modular invariant corresponding to the unit object considered as a connected étale algebra). All other symmetric modular invariants will be labelled *exceptional*. The following is a consequence of the classification of \mathfrak{sl}_3 modular invariants due to Gannon [22, Theorem 1].

Theorem 2 (Gannon). *The only exceptional symmetric modular invariants for \mathfrak{sl}_3 occur at levels $k = 5, 9,$ and 21 .*

Translating this into our discussion of Witt class representatives and the decompositions/reductions found in Sections 3.2.2. and 3.2.3., we have the following corollary.

Corollary 3. *The categories $\mathcal{C}(\mathfrak{sl}_3, 3m + 1)'_{pt}$ and $\mathcal{C}(\mathfrak{sl}_3, 3m + 2)'_{pt}$ are completely anisotropic for $m \in \mathbb{Z}_{>0}$ and $3m + 2 \neq 5$, while $\mathcal{C}(\mathfrak{sl}_3, 3m)_A^0$ is completely anisotropic for $m \in \mathbb{Z}_{\geq 2}$ and $3m \neq 9, 21$.*

Proof. We begin by noting that $A \in \mathcal{C}(\mathfrak{sl}_3, 3m)$ as described in Section 3.2.3. must be a maximal connected étale algebra when $k \neq 9, 21$. If not, by the method described in the introduction to this section, one could create an exceptional modular invariant at this level contradicting Theorem 2. Hence $\mathcal{C}(\mathfrak{sl}_3, 3m)_A^0$ is completely anisotropic when $k \neq 9, 21$.

By this exact argument, no nontrivial connected étale algebra exists in $\mathcal{C}(\mathfrak{sl}_3, 3m + 1)$ or $\mathcal{C}(\mathfrak{sl}_3, 3m + 2)$ when $3m + 2 \neq 5$. Finally if A is a connected étale algebra in a braided fusion category \mathcal{C} , and \mathcal{D} is any other braided fusion category, then $A \boxtimes \mathbf{1}$ is a connected étale algebra in $\mathcal{C} \boxtimes \mathcal{D}$ [11, Section 3.2]. Moreover the lack of connected étale algebras in $\mathcal{C}(\mathfrak{sl}_3, 3m + 1)$ or $\mathcal{C}(\mathfrak{sl}_3, 3m + 2)$ when $3m + 2 \neq 5$

implies that the simple factors of these categories are completely anisotropic as well. \square

In the cases $k = 5, 9, 21$ we will use alternative methods to identify completely anisotropic representatives of the Witt classes of $\mathcal{C}(\mathfrak{sl}_3, k)$. In particular the theory of *conformal embeddings* can be used to construct relations among the classes $[\mathcal{C}(\mathfrak{g}, k)]$ for any finite dimensional simple Lie algebra \mathfrak{g} [10, Section 6.2]. A complete classification of such conformal embeddings is given in [2] and [40].

Each conformal embedding $\mathfrak{g} \subset \mathfrak{g}'$ gives rise to equivalences of the form $[\mathcal{C}(\mathfrak{g}, k)] = [\mathcal{C}(\mathfrak{g}', k')]$ for some levels $k, k' \in \mathbb{Z}_{>0}$. Three conformal embeddings are of interest for the classification of \mathfrak{sl}_3 relations: $A_{2,9} \subseteq E_{6,1}$, $A_{2,21} \subseteq E_{7,1}$, and $A_{2,5} \subseteq A_{5,1}$. These embeddings will be used implicitly in the proof of the following proposition.

Proposition 5. *The following relations hold in the Witt group \mathcal{W} :*

- (a) $[\mathcal{C}(\mathfrak{sl}_3, 9)] = [\mathcal{C}(\mathfrak{sl}_3, 2)_{pt}]$
- (b) $[\mathcal{C}(\mathfrak{sl}_3, 21)] = [(\mathcal{C}(\mathfrak{sl}_2, 1)^{rev})]$, and
- (c) $[\mathcal{C}(\mathfrak{sl}_3, 5)] = [\mathcal{C}(\mathfrak{sl}_5, 1)] = [\mathcal{C}(\mathbb{Z}/5\mathbb{Z}, q)]$.

Proof. The category $\mathcal{C}(E_6, 1)$ is pointed with three simple objects. Using Proposition 4 we compute $\xi(\mathcal{C}(E_6, 1)) = \exp((2\pi i)/8(1 \cdot 78)/(1 + 12)) = -i$. Pointed categories $\mathcal{C}(\mathbb{Z}/3\mathbb{Z}, q)$ are determined by their central charge and thus $\mathcal{C}(E_6, 1) \simeq \mathcal{C}(\mathbb{Z}/3\mathbb{Z}, q_{\omega^2}) \simeq \mathcal{C}(\mathfrak{sl}_3, 2)_{pt}$, which is simple and completely anisotropic implying relation (a). Similarly the category $\mathcal{C}(E_7, 1)$ is pointed with two simple objects. Using Proposition 4 we find $\xi(\mathcal{C}(E_7, 1)) = \exp((2\pi i/8)(1 \cdot 133)/(1 + 18)) = (1 - i)/\sqrt{2}$. Pointed categories $\mathcal{C}(\mathbb{Z}/2\mathbb{Z}, q)$ are also determined by their central charge and thus $\mathcal{C}(E_7, 1) \simeq \mathcal{C}(\mathbb{Z}/2\mathbb{Z}, q_-)$, where $q_-(1) = -i$, which is simple and completely anisotropic. This is a familiar category coming from \mathfrak{sl}_2 . Proposition 4 implies $\xi(\mathcal{C}(\mathfrak{sl}_2, 1)) = \exp((2\pi i/8)(1 \cdot 3)/(1 + 2)) = (1 + i)/\sqrt{2}$. Lemma 1 (c) then implies $\xi(\mathcal{C}(\mathfrak{sl}_2, 1)^{rev}) = (1 - i)/\sqrt{2}$ which gives relation (b). Lastly $\mathcal{C}(\mathfrak{sl}_5, 1)$ is pointed

with five simple objects. As noted in Example 6.2 of [10], $\mathcal{C}(\mathfrak{sl}_n, 1) \simeq \mathcal{C}(\mathbb{Z}/n\mathbb{Z}, q)$ where $q(\ell) = \exp(\pi i \ell^2(n-1)/n)$ and hence relation (c) follows. \square

4.2. A Classification of \mathfrak{sl}_3 Relations

Theorem 3. *The only relations in the Witt group of nondegenerate braided fusion categories \mathcal{W} coming from the subgroup generated by $[\mathcal{C}(\mathfrak{sl}_3, k)]$ are the following:*

$$(3.a) \quad [\mathcal{C}(\mathfrak{sl}_3, 1)]^4 = [\text{Vec}],$$

$$(3.b) \quad [\mathcal{C}(\mathfrak{sl}_3, 3)]^2 = [\text{Vec}],$$

$$(3.c) \quad [\mathcal{C}(\mathfrak{sl}_3, 5)]^2 = [\text{Vec}],$$

$$(3.d) \quad [\mathcal{C}(\mathfrak{sl}_3, 1)]^3 = [\mathcal{C}(\mathfrak{sl}_3, 9)], \text{ and}$$

$$(3.e) \quad [\mathcal{C}(\mathfrak{sl}_3, 21)]^8 = [\text{Vec}].$$

Proof. Our approach to this proof will be to show that the above relations hold, and then prove that these are the only relations which can exist by identifying the unique representatives of each class $[\mathcal{C}(\mathfrak{sl}_3, k)]$ as described in Section 2.4..

Since $\mathcal{C}(\mathfrak{sl}_3, k)$ in equations (3.a)–(3.e) above are all Witt equivalent to a pointed modular tensor category by the computations in Proposition 4 (a), Example 4, and Proposition 5, the relations follow from the exposition in Appendix A.7 of [14] which explicitly describes the pointed subgroup $\mathcal{W}_{\text{pt}} \subset \mathcal{W}$. The remaining question is whether these relations are exhaustive.

By Proposition 4, Theorem 1, and Corollary 3 for $m \in \mathbb{Z}_{\geq 0}$ we have collected simple, completely anisotropic, nondegenerate braided fusion categories

$$\mathcal{C}(\mathfrak{sl}_3, 3m+1)'_{\text{pt}}, \quad \text{for } m \neq 0 \quad (16)$$

$$\mathcal{C}(\mathfrak{sl}_3, 3m+2)'_{\text{pt}}, \quad \text{for } m \neq 1 \quad (17)$$

$$\mathcal{C}(\mathfrak{sl}_3, 3m)_A^0, \quad \text{for } m \neq 0, 1, 3, 7 \quad (18)$$

We claim the categories in the above families are not equivalent and will prove

this by noting their central charges are distinct using Lemma 4 and Lemma 2. For $m = 0, 1, 2$ one can manually verify the proposed central charges are distinct. If $\arg(z)$ is the complex argument of $z \in \mathbb{C}$, for $m \in \mathbb{Z}_{\geq 3}$ we have

$$0 < \arg \xi(\mathcal{C}(\mathfrak{sl}_3, 3m+2)'_{\text{pt}}) < \pi/2 \quad (19)$$

$$\pi < \arg \xi(\mathcal{C}(\mathfrak{sl}_3, 3m+1)'_{\text{pt}}) < 3\pi/2, \text{ and} \quad (20)$$

$$3\pi/2 \leq \arg \xi(\mathcal{C}(\mathfrak{sl}_3, 3m)_A^0) < 2\pi. \quad (21)$$

Recall the *Witt group of slightly degenerate braided fusion categories*, $s\mathcal{W}$, introduced in [11]. Studying this alternate Witt group is advantageous because slightly degenerate braided fusion categories admit a unique decomposition into s -simple components [11, Definition 4.9, Theorem 4.13], and consequentially there are no nontrivial relations in $s\mathcal{W}$ other than relations of the form $[\mathcal{C}] = [\mathcal{C}]^{-1}$ [11, Remark 5.11]. The categories in (16)–(18) are simple and unpointed, hence their image under the group homomorphism $S : \mathcal{W} \rightarrow s\mathcal{W}$ [11, Section 5.3] is s -simple. Their image is also completely anisotropic and slightly degenerate. Hence any nontrivial relation in \mathcal{W} between these categories would pass to a relation in $s\mathcal{W}$ under the map S and this relation is nontrivial provided they are not in the kernel of S , which is $\mathcal{W}_{\text{Ising}}$ consisting of the Witt equivalence classes of the Ising braided categories.

When $[\mathcal{C}] = [\mathcal{C}]^{-1}$ in $s\mathcal{W}$, $\mathcal{C} \simeq \mathcal{C}^{\text{rev}}$ which implies $\xi(\mathcal{C}) = \pm 1$. This cannot be true of the categories in (16)–(18) by the inequalities in (19)–(21) and a manual check in the case $m = 0, 1, 2$. Thus the relations (3.a)–(3.e) are exhaustive. \square

Once relations in the subgroups individually generated by $[\mathcal{C}(\mathfrak{sl}_2, k)]$ and $[\mathcal{C}(\mathfrak{sl}_3, k)]$ are classified one should then classify all relations between the two families.

Theorem 4. *All nontrivial relations between the equivalency classes $[\mathcal{C}(\mathfrak{sl}_2, k)]$ and $[\mathcal{C}(\mathfrak{sl}_3, k)]$ are generated by*

$$\begin{aligned}
(4.a) \quad & [\mathcal{C}(\mathfrak{sl}_3, 3)] = [\mathcal{C}(\mathfrak{sl}_2, 2)]^8, \\
(4.b) \quad & [\mathcal{C}(\mathfrak{sl}_3, 3)][\mathcal{C}(\mathfrak{sl}_2, 2)]^{11} = [\mathcal{C}(\mathfrak{sl}_2, 6)]^2, \\
(4.c) \quad & [\mathcal{C}(\mathfrak{sl}_3, 3)][\mathcal{C}(\mathfrak{sl}_2, 2)]^{15} = [\mathcal{C}(\mathfrak{sl}_2, 10)]^7, \\
(4.d) \quad & [\mathcal{C}(\mathfrak{sl}_3, 21)][\mathcal{C}(\mathfrak{sl}_2, 1)] = [\text{Vec}], \\
(4.e) \quad & [\mathcal{C}(\mathfrak{sl}_3, 2)][\mathcal{C}(\mathfrak{sl}_2, 28)] = [\mathcal{C}(\mathfrak{sl}_3, 9)], \\
(4.f) \quad & [\mathcal{C}(\mathfrak{sl}_2, 4)] = [\mathcal{C}(\mathfrak{sl}_3, 1)], \\
(4.g) \quad & [\mathcal{C}(\mathfrak{sl}_2, 4)]^3 = [\mathcal{C}(\mathfrak{sl}_3, 9)], \\
(4.h) \quad & [\mathcal{C}(\mathfrak{sl}_3, 6)][\mathcal{C}(\mathfrak{sl}_2, 16)] = [\text{Vec}], \text{ and} \\
(4.i) \quad & [\mathcal{C}(\mathfrak{sl}_3, 4)][\mathcal{C}(\mathfrak{sl}_3, 1)] = [\mathcal{C}(\mathfrak{sl}_2, 12)].
\end{aligned}$$

To organize the search for these relations we will proceed in two stages: first we consider coincidences between the \mathfrak{sl}_3 relations from Theorem 3 and those \mathfrak{sl}_2 relations found in [11, Section 5.5]:

$$[\mathcal{C}(\mathfrak{sl}_2, 1)]^8 = [\text{Vec}], \tag{22}$$

$$[\mathcal{C}(\mathfrak{sl}_2, 8)] = [\mathcal{C}(\mathfrak{sl}_2, 3)]^{-2}[\mathcal{C}(\mathfrak{sl}_2, 1)]^2, \tag{23}$$

$$[\mathcal{C}(\mathfrak{sl}_2, 28)] = [\mathcal{C}(\mathfrak{sl}_2, 3)][\mathcal{C}(\mathfrak{sl}_2, 1)]^{-1}, \tag{24}$$

$$[\mathcal{C}(\mathfrak{sl}_2, 4)]^4 = [\text{Vec}], \tag{25}$$

$$[\mathcal{C}(\mathfrak{sl}_2, 2)]^{16} = [\text{Vec}], \tag{26}$$

$$[\mathcal{C}(\mathfrak{sl}_2, 10)] = [\mathcal{C}(\mathfrak{sl}_2, 7)]^7, \text{ and} \tag{27}$$

$$[\mathcal{C}(\mathfrak{sl}_2, 6)]^2 = [\mathcal{C}(\mathfrak{sl}_2, 2)]^3. \tag{28}$$

Secondly we compare the lists of simple completely anisotropic Witt class

representatives for \mathfrak{sl}_3 found in (16)–(18) and those for \mathfrak{sl}_2 found in [11, Section 5.5]:

$$\mathcal{C}(\mathfrak{sl}_2, 2\ell + 1)'_{\text{pt}}, \ell \geq 1, \quad (29)$$

$$\mathcal{C}(\mathfrak{sl}_2, 4\ell)_A^0, \ell \geq 3, \ell \neq 7, \text{ and} \quad (30)$$

$$\mathcal{C}(\mathfrak{sl}_2, 4\ell + 2)'_{\text{pt}}, \ell \geq 3. \quad (31)$$

For the first stage we have $[\mathcal{C}(\mathfrak{sl}_3, 3)] = [\mathcal{C}(\mathfrak{sl}_3, 3)_A^0]$ is in $\mathcal{W}_{\text{Ising}}$. By (26) this is a cyclic group of order 16 which is generated by $[\mathcal{C}(\mathfrak{sl}_2, 2)]$, giving relation (4.a). Multiplying relation (4.a) by $[\mathcal{C}(\mathfrak{sl}_2, 2)]^{11}$ gives relation (4.b) using (28) and multiplying relation (4.a) by $[\mathcal{C}(\mathfrak{sl}_2, 2)]^{15}$ gives relation (4.c) using (27).

Proposition 5 (b) implies relation (4.d). The relation implied by Proposition 4 (b) is $[\mathcal{C}(\mathfrak{sl}_3, 2)][\mathcal{C}(\mathfrak{sl}_2, 3)'_{\text{pt}}] = [\mathcal{C}(\mathfrak{sl}_3, 2)_{\text{pt}}]$. But together with (24) and Proposition 5 (a) we have relation (4.e).

Relation (25) is very similar to relations (3.a) and (3.c), and this is no coincidence since there exists a conformal embedding $A_{1,4} \subset A_{3,1}$, yielding relation (4.f). Lastly cubing relation (4.f) and applying relation (3.d) implies relation (4.g).

For stage 2 of our proof, a first deduction can be made by noting that the categories (29) and (31) are self dual. There are only three self dual categories in (16)–(18): $\mathcal{C}(\mathfrak{sl}_3, 2)'_{\text{pt}}$, $\mathcal{C}(\mathfrak{sl}_3, 3)_A^0$, and $\mathcal{C}(\mathfrak{sl}_3, 6)_A^0$. The first is equivalent to $(\mathcal{C}(\mathfrak{sl}_2, 3)'_{\text{pt}})^{\text{rev}}$ as noted in Proposition 3.2.2. (b) and the implied relations were discussed above, while the Witt equivalence class of the second was previously treated as an element of $\mathcal{W}_{\text{Ising}}$. It remains to show that $\mathcal{C}(\mathfrak{sl}_3, 6)_A^0$ is not equivalent to $\mathcal{C}(\mathfrak{sl}_2, 11)'_{\text{pt}}$ since these categories have the same number of simple objects. To this end the formula in [10, Section 6.4 (1)] and Lemma 4 imply their central charges are not equal.

The last step of stage 2 is to check that none of the categories $\mathcal{C}(\mathfrak{sl}_2, 4\ell)_A^0$ are equivalent to the categories in (16)–(18) (or their reverse categories). We will do

so by comparing central charges. Lemma 4 states for $\ell \in \mathbb{Z}_{\geq 1}$

$$\arg \xi (\mathcal{C}(\mathfrak{sl}_2, 4\ell)_A^0) = \frac{3\ell\pi}{4\ell + 2}$$

and thus $\pi/2 < \arg \xi (\mathcal{C}(\mathfrak{sl}_2, 4\ell)_A^0) < \pi$. There are possible exceptional equivalences of the form $\mathcal{C} \simeq \mathcal{D}^{\text{rev}}$ since $\arg \xi (\mathcal{C}(\mathfrak{sl}_2, 4)_A^0) + \arg \xi (\mathcal{C}(\mathfrak{sl}_3, 9)_A^0) = 2\pi$, $\arg \xi (\mathcal{C}(\mathfrak{sl}_2, 16)_A^0) + \arg \xi (\mathcal{C}(\mathfrak{sl}_3, 6)_A^0) = 2\pi$, $\arg \xi (\mathcal{C}(\mathfrak{sl}_2, 28)_A^0) + \arg \xi (\mathcal{C}(\mathfrak{sl}_3, 2)'_{\text{pt}}) = 0$, and $\arg \xi (\mathcal{C}(\mathfrak{sl}_2, 12)_A^0) = \arg \xi (\mathcal{C}(\mathfrak{sl}_3, 4)'_{\text{pt}})$. The first case was considered in relation (4.g). In the second case not much work is needed since there is a conformal embedding $A_{2,6} \times A_{1,16} \subset E_{8,1}$ which gives relation (4.h). The third case was considered in relation (4.e). The last case is caused from the equivalence $\mathcal{C}(\mathfrak{sl}_3, 4)'_{\text{pt}} \simeq \mathcal{C}(\mathfrak{sl}_2, 12)_A^0$ by the classification of rank 5 modular tensor categories [6], giving relation (4.i).

CHAPTER V

CONNECTED ÉTALE ALGEBRAS IN $\mathcal{C}(\mathfrak{g}, k)$

Chapter V has previously appeared in [42].

The results of Chapter IV relied heavily on Theorem 2. There is no known proof of an analogous statement for Lie algebras other than \mathfrak{sl}_2 and \mathfrak{sl}_3 . In Theorem 5 we provide a bound on levels k for which exceptional symmetric modular invariants can exist in $\mathcal{C}(\mathfrak{so}_5, k)$ and $\mathcal{C}(\mathfrak{g}_2, k)$, reproving this known result for $\mathcal{C}(\mathfrak{sl}_2, k)$ and $\mathcal{C}(\mathfrak{sl}_3, k)$ to demonstrate the generality of the argument.

5.1. Technical Machinery

The numerical conditions for an algebra in a pseudo-unitary pre-modular category to be connected étale are quite restrictive. In particular the full twist on such an algebra is trivial as we will prove below. This result is due to Victor Ostrik, although a proof does not appear in the literature to our knowledge. The full twist need not be trivial if the assumption of pseudo-unitary is removed as the following example illustrates.

Example 7. The fusion category of complex $\mathbb{Z}/2\mathbb{Z}$ -graded vector spaces has two possible (symmetric) pre-modular structures, distinguished by the full twist on the non-trivial simple object $\theta(X) = \pm 1$. The trivial twist corresponds to the pseudo-unitary category $\text{Rep}(\mathbb{Z}/2\mathbb{Z})$, while the nontrivial twist corresponds to sVec , the category of complex super vector spaces [17, Example 8.2.2]. The object $A := \mathbf{1} \oplus X$ has a unique structure of a connected étale algebra in both cases, but $\theta(A) \neq \text{id}_A$ in sVec , which is *not* pseudo-unitary (i.e. $\dim(X) = -1$).

Lemma 8. *If \mathcal{C} is a pseudo-unitary premodular category and A is a connected étale algebra in \mathcal{C} , then $\theta(A) = \text{id}_A$.*

Proof. The composition $\varphi : A \otimes A \xrightarrow{m} A \xrightarrow{\varepsilon_A} \mathbf{1}$ is non-degenerate [10, Remark 3.4], where ε_A arises from A being connected (and is unique up to scalar multiple). Note that the commutativity of A implies $\varphi s_{X^*, X} s_{X, X^*} = \varphi$. We can then rewrite $s_{X^*, X} s_{X, X^*}$ using the balancing axiom [3, Equation 2.2.8] to yield $\theta(X)\theta(X^*)\theta(\mathbf{1})^{-1} = 1$ because φ is nondegenerate. Moreover $\theta(X) = \pm 1$. So we may now decompose $A = A^+ \oplus A^-$ where A^\pm is the sum of simple summands of A with twist ± 1 , respectively. We will deduce that A^- is empty in the remainder of the proof.

The commutativity of $A = A^+ \oplus A^-$ implies this decomposition is a $\mathbb{Z}/2\mathbb{Z}$ -grading again by the balancing axiom, i.e. $\theta(X \otimes Y) = \theta(X)\theta(Y)$ for all simple $X, Y \subset A$. Thus m restricts to a multiplication morphism $A^+ \otimes A^+ \rightarrow A^+$. We now aim to prove that A^+ is a connected étale algebra. The commutativity of A^+ is clear from the commutativity of A and $\theta(\mathbf{1}) = 1$ by the balancing axiom [3, Equation 2.2.9] so A^+ is connected. It remains to show that A^+ is separable, i.e. \mathcal{C}_{A^+} is semisimple. This follows from [27, Theorem 3.3] by recalling that A^+ is *rigid* (in the sense of Kirillov and Ostrik) because $A^+ \otimes A^+ \xrightarrow{m} A^+ \xrightarrow{\varepsilon_A} \mathbf{1}$ is non-degenerate, and $\dim(A) \neq 0$ since \mathcal{C} is pseudo-unitary.

In the language of [10, Section 3.6], A with the inclusion $A^+ \rightarrow A$ is known as a commutative algebra *over* A^+ and thus A can be considered as a commutative algebra in $\mathcal{D} := \mathcal{C}_{A^+}^0$. Proposition 3.16 of [10] then implies A (as an algebra in \mathcal{D}) is connected étale as well. We also note that $\theta(A^+) = \text{id}_{A^+}$ along with Theorem 1.18 of [27], implies $\dim(\mathcal{D}) = \sum_{X \in \mathcal{O}(\mathcal{D})} \dim_{\mathcal{D}}(X)^2$ is equal to

$$\sum_{X \in \mathcal{O}(\mathcal{D})} \left(\frac{\dim_{\mathcal{C}}(X)}{\dim_{\mathcal{C}}(A)} \right)^2 = \text{FPdim}_{\mathcal{C}}(A)^{-2} \sum_{X \in \mathcal{O}(\mathcal{D})} \text{FPdim}_{\mathcal{C}}(X)^2 \quad (32)$$

$$\begin{aligned} &= \text{FPdim}_{\mathcal{C}}(A)^{-2} \text{FPdim}(\mathcal{C}) \\ &= \text{FPdim}(\mathcal{D}). \end{aligned} \quad (33)$$

where (32) follows from \mathcal{C} being pseudo-unitary and [10, Corollary 3.32] implies (33). Moreover we have shown \mathcal{D} is pseudo-unitary by Proposition 8.23 of [16].

Now assume $X \subset A$ is a simple summand of A (as an object of \mathcal{D}) which is *distinct* from $A^+ = \mathbf{1}_{\mathcal{D}}$. An immediate consequence is that $X \subset A^-$, should such an object exist. But $X \otimes_{\mathcal{D}} X$ is a quotient of $X \otimes X$ [27, Theorem 1.5] which, by the $\mathbb{Z}/2\mathbb{Z}$ -grading of A , implies $X \otimes_{\mathcal{D}} X \subset A^+ = \mathbf{1}_{\mathcal{D}}$. The simplicity of the unit object $\mathbf{1}_{\mathcal{D}} = A^+$ then implies $X \otimes_{\mathcal{D}} X = \mathbf{1}_{\mathcal{D}}$.

Lastly we consider the fusion subcategory $\mathcal{E} \subset \mathcal{D}$ generated by X , which by the above reasoning is equivalent to the category of $\mathbb{Z}/2\mathbb{Z}$ -graded vector spaces (as a fusion category). The spherical structure of \mathcal{E} which is inherited from \mathcal{D} , must be the nontrivial one since $\theta(X) = -1$ (see Example 7) and thus $\mathcal{E} = \text{sVec}$, a contradiction to \mathcal{D} being pseudo-unitary. Moreover no such X can exist and $A = A^+$. \square

Now let A be a connected étale algebra in $\mathcal{C} := \mathcal{C}(\mathfrak{g}, k)$ where \mathfrak{g} is \mathfrak{sl}_3 , \mathfrak{so}_5 , or \mathfrak{g}_2 and $(\ell, m) \subset A$ be a nontrivial summand of A which is minimal in the sense that $\ell + m$ is minimal in the case of \mathfrak{sl}_3 and \mathfrak{so}_5 , and $\ell + (3/2)m$ is minimal in the case of \mathfrak{g}_2 . The reasons for this distinction will be explained in the proof of Lemma 9.

Note 9. Our goal is not to reprove Theorem 5 in the rank 1 case so it will be satisfactory to point out the following lemmas can be restated for $\mathcal{C}(\mathfrak{sl}_2, k)$ where (ℓ) is the analogous minimal nontrivial summand of $A \in \mathcal{C}(\mathfrak{sl}_2, k)$.

Lemma 9. *If $(s, t) \in \Lambda_0$ and $2(s + t) < \ell + m$ in the case $\mathfrak{g} = \mathfrak{sl}_3, \mathfrak{so}_5$, or $2(s + (3/2)t) < \ell + (3/2)m$ in the case $\mathfrak{g} = \mathfrak{g}_2$, then $(s, t) \otimes A$ is a simple right A -module.*

Proof. Label $\lambda := (s, t)$. Then we have by [35, Lemma 2, Lemma 4]

$$\text{Hom}_{\mathcal{C}_A}(\lambda \otimes A, \lambda \otimes A) = \text{Hom}_{\mathcal{C}}(\lambda, \lambda \otimes A) = \text{Hom}_{\mathcal{C}}(\lambda \otimes \lambda^*, A). \quad (34)$$

The highest weight in $\Pi(\lambda : \lambda^*)$ is $\gamma := (s + t, s + t)$ when $\mathfrak{g} = \mathfrak{sl}_3$ and $\gamma := (2s, 2t)$ when $\mathfrak{g} = \mathfrak{so}_5, \mathfrak{g}_2$. The respective assumptions on (s, t) relative to (ℓ, m) in our hypotheses imply $\gamma \neq (\ell, m)$ and it remains to check no other weights

$(s', t') \in \Pi(\lambda : \lambda^*)$ are equal to (ℓ, m) either. To this end it will suffice to check $\gamma - \alpha \neq (\ell, m)$ for each simple root α since our claim follows inductively on dominance ordering. If $\mathfrak{g} = \mathfrak{sl}_3$, $\gamma - \alpha_1 = (s + t - 2, s + t + 1)$ which is not equal to (ℓ, m) since $s + t - 2 + s + t + 1 = 2(s + t) - 1 < \ell + m$ and symmetrically for α_2 . If $\mathfrak{g} = \mathfrak{so}_5$, $\gamma - \alpha_1 = (2s - 2, 2t + 2)$ which is not equal to (ℓ, m) since $2s - 2 + 2t + 2 = 2(s + t) < \ell + m$ and $\gamma - \alpha_2 = (2s + 1, 2t - 2)$ which is not equal to (ℓ, m) since $2s + 1 + 2t - 2 = 2(s + t) - 1 < \ell + m$. Lastly if $\mathfrak{g} = \mathfrak{g}_2$, $\gamma - \alpha_1 = (2s - 2, 2t + 1)$ which is not equal to (ℓ, m) since $2s - 2 + (3/2)(2t + 1) = 2(s + (3/2)t) - 1/2 < \ell + (3/2)m$, and $\gamma - \alpha_2 = (2s + 3, 2t - 2)$ which is not equal to (ℓ, m) since $2s + 3 + (3/2)(2t - 2) = 2(s + (3/2)t) < \ell + (3/2)m$. Moreover the right-hand side of (34) is one-dimensional and $\lambda \otimes A$ is a simple object in \mathcal{C}_A . \square

Lemma 10. *If $M \in \mathcal{C}_A$, and $(s, t) \subset M$ satisfies the hypotheses of Lemma 9, then $(s, t) \otimes A$ is a right A -submodule of M .*

Proof. As in the proof of Lemma 9 with $\lambda := (s, t)$, compute $\text{Hom}_{\mathcal{C}_A}(\lambda \otimes A, M) = \text{Hom}_{\mathcal{C}}(\lambda, M)$. By assumption and Lemma 9, $\lambda \otimes A$ is simple, hence the result is proven since the right-hand side is nontrivial. \square

Corollary 4. *For all $(s, t) \in \Lambda_0$ and $\{(s_i, t_i)\}_{i \in I}$, collections of simple summands of $M = (s, t) \otimes A$ satisfying the assumptions of Lemma 9,*

$$\sum_{i \in I} \dim'(s_i, t_i) \leq \dim'(s, t).$$

Proof. Apply Lemma 10 to each element of $\{(s_i, t_i)\}_{i \in I}$. For each (s_i, t_i) we then have $(s_i, t_i) \otimes A \subset (s, t) \otimes A$. Taking dimensions of the containment provides the inequality, then $\dim(A)$ can be divided out and denominators cleared. \square

Exact computations are often intractable with quantum analogs so we now collect a set of results that will be used frequently in the sequel to verify when inequalities of the type in Corollary 4 are true or false. An illustration of the trigonometric formulas for $q^n \pm q^{-n}$ in terms of sine or cosine when q is a root of

unity can be found in [41, Figure 3]. Set $\varepsilon(\mathfrak{g}, k)$ to be the denominator of $\ln q$ (see Figure 1.).

Lemma 11. *If $n, m \in \mathbb{Z}_{\geq 1}$, then $[n + m] \leq [n] + m$.*

Proof. We will present a proof in the case m is even, leaving the near-identical case of odd m to the reader. Carrying out the long division and simplifying yields

$$\begin{aligned}
[n + m] - [n] &= \left(\frac{q^{n+m} - q^{-(n+m)}}{q - q^{-1}} \right) - \left(\frac{q^n - q^{-n}}{q - q^{-1}} \right) \\
&= (q^{n+m-1} + q^{n+m-3} + \dots + q^{-(n+m-3)} + q^{-(n+m-1)}) \\
&\quad - (q^{n-1} + q^{n-3} + \dots + q^{-(n-3)} + q^{-(n-1)}) \\
&= \sum_{i=1}^{m/2} (q^{n-1+2i} + q^{-(n-1+2i)}) \\
&= 2 \sum_{i=1}^{m/2} \cos \left(\frac{(n-1+2i)\pi}{\varepsilon(\mathfrak{g}, k)} \right) \\
&\leq m
\end{aligned}$$

by the triangle inequality. □

Corollary 5. *If $n \in \mathbb{Z}_{\geq 1}$, then $[n] \leq n$.*

Lemma 12. *If $n \in \mathbb{Z}_{\geq 1}$ and $n \leq \frac{1}{2}\varepsilon(\mathfrak{g}, k)$, then $[n] \geq \frac{1}{2}n$.*

Proof. Note that

$$[n] = \sin \left(\frac{n\pi}{\varepsilon(\mathfrak{g}, k)} \right) \left(\sin \left(\frac{\pi}{\varepsilon(\mathfrak{g}, k)} \right) \right)^{-1}.$$

We have $0 \leq n \leq \varepsilon(\mathfrak{g}, k)$ by assumption so we may use the inequalities $\sin(x) \geq x(1 - x/\pi)$ (for $0 \leq x \leq \pi$) and $1/\sin(x) \geq 1/x$ (for $x > 0$) to yield

$$\begin{aligned}
[n] &\geq \left(\frac{\varepsilon(\mathfrak{g}, k)}{\pi} \right) \left(\frac{n\pi}{\varepsilon(\mathfrak{g}, k)} \right) \left(1 - \frac{n}{\varepsilon(\mathfrak{g}, k)} \right) \\
&= n \left(1 - \frac{n}{\varepsilon(\mathfrak{g}, k)} \right) \\
&\geq \frac{1}{2}n.
\end{aligned}$$

□

5.2. Exceptional Algebras

In [27], connected étale algebras in $\mathcal{C}(\mathfrak{sl}_2, k)$ are organized into an ADE classification scheme paralleling the classification of simply-laced Dynkin diagrams. The connected étale algebra of type A is the trivial one given by the unit object $\mathbf{1} \in \mathcal{C}(\mathfrak{sl}_2, k)$. Those connected étale algebras of type D arise at even levels in the following manner. The fusion subcategory $\mathcal{C}(\mathfrak{sl}_2, 2k)_{\text{pt}} \subset \mathcal{C}(\mathfrak{sl}_2, 2k)$ generated by invertible objects is equivalent to $\text{Rep}(\mathbb{Z}/2\mathbb{Z})$ and all connected étale algebras in $\text{Rep}(\mathbb{Z}/2\mathbb{Z})$ are in one-to-one correspondence with subgroups of $\mathbb{Z}/2\mathbb{Z}$ as the additional cohomological data from [34, Theorem 3.1] is trivial for cyclic groups. Type A algebras correspond to the trivial subgroup in the type D construction, so we will refer to both types as *standard* in this exposition, and any algebra that does not arise from this construction as *exceptional*.

Example 8. Extending the notation from Section 3.1., simple objects of $\mathcal{C}(\mathfrak{sl}_n, nk)$ for $k \in \mathbb{Z}_{\geq 1}$ are enumerated by positive integer $(n-1)$ -tuples $(s_1, s_2, \dots, s_{n-1})$ such that $s_1 + s_2 + \dots + s_{n-1} \leq nk$. The fusion subcategory $\mathcal{C}(\mathfrak{sl}_n, nk)_{\text{pt}} \simeq \text{Rep}(\mathbb{Z}/n\mathbb{Z})$ has simple objects $(s_1, s_2, \dots, s_{n-1})$ such that $s_i = nk$ and $s_j = 0$ for all $j \neq i$, along with the trivial object. Standard connected étale algebras in $\mathcal{C}(\mathfrak{sl}_n, nk)$ are again in one-to-one correspondence with subgroups of $\mathbb{Z}/n\mathbb{Z}$. All exceptional connected étale algebras in $\mathcal{C}(\mathfrak{sl}_2, k)$ are succinctly listed in [27, Table 1], while all exceptional connected étale algebras in $\mathcal{C}(\mathfrak{sl}_3, k)$ are listed using modular invariants [22, Equations 2.7d, 2.7e, 2.7g] at levels $k = 5, 9, 21$. The theory of conformal embeddings provides examples of exceptional connected étale algebras in $\mathcal{C}(\mathfrak{sl}_4, k)$ at levels $k = 4, 6, 8$, which are described in detail in [9].

Example 9. There are no nontrivial standard connected étale algebras in $\mathcal{C}(\mathfrak{g}_2, k)$ since $\mathcal{C}(\mathfrak{g}_2, k)_{\text{pt}} \simeq \text{Vec}$, but there are two standard connected étale algebras in $\mathcal{C}(\mathfrak{so}_5, 2k)$ since $\mathcal{C}(\mathfrak{so}_5, 2k)_{\text{pt}} \simeq \text{Rep}(\mathbb{Z}/2\mathbb{Z})$ corresponding to $(0, 0)$ and $(0, 0) \oplus (k, 0)$. For odd levels k , $\theta(k, 0) = -1$ and so by Lemma 8, $(0, 0) \oplus (k, 0)$ does not have the structure of a connected étale algebra. As in Example 8, the theory of

conformal embeddings provides examples of exceptional connected étale algebras in $\mathcal{C}(\mathfrak{g}_2, k)$ at levels $k = 3, 4$ and $\mathcal{C}(\mathfrak{so}_5, k)$ at levels $k = 2, 3, 7, 12$, which are described in detail in [8].

Theorem 5. *There exist finitely many levels $k \in \mathbb{Z}_{\geq 1}$ such that $\mathcal{C}(\mathfrak{so}_5, k)$ or $\mathcal{C}(\mathfrak{g}_2, k)$ contains an exceptional connected étale algebra.*

The proof of this result is contained in Section 5.3. but illustrated below in the following example for \mathfrak{sl}_2 and \mathfrak{sl}_3 .

Example 10 ($\mathcal{C}(\mathfrak{sl}_2, k)$). If A is an exceptional connected étale algebra in $\mathcal{C}(\mathfrak{sl}_2, k)$ with minimal nontrivial summand (ℓ) , Lemma 8 applied to the full twist formula in Section 3.1. implies (ℓ) is in the root lattice, i.e. ℓ is even, say $\ell = 2m$ for some $m \in \mathbb{Z}_{\geq 1}$ and $2m < k$. Explicit fusion rules for $\mathcal{C}(\mathfrak{sl}_2, k)$ are well-known [10, Section 2.8], and we see that $(m+3) \otimes (2m)$ contains summands $(m-1)$ and $(m-3)$ provided $3 \leq m < k$. Moreover Corollary 4 then implies

$$[m] + [m-2] < [m+4] \tag{35}$$

$$< [m] + 4 \tag{36}$$

$$\Rightarrow \frac{1}{2}(m-2) < 4 \tag{37}$$

where (36) results from applying Corollary 5 to the right-hand side of (35) and (37) results from applying Lemma 12 to the left-hand side of (36) which is justified because $2m < k$ implies $m-2 \leq (1/2)(k+2)$. The inequality in (37) is false for $m > 9$. Moreover $\theta(\ell) = 1$ by Lemma 8 and so $m(m+1) - 2 \geq k$ which implies $k \leq 88$ if $m \leq 9$.

Note 10. It is possible to show from the definition of $[n]$ that the inequality in (35) is false in a more restricted setting: $m > 5$, which then implies $k \leq 28$. But there exists an exceptional connected étale algebra in $\mathcal{C}(\mathfrak{sl}_2, 28)$ corresponding to the object $(0) \oplus (10) \oplus (18) \oplus (28)$ (type E_8 in the ADE classification [27, Section 6]) and so this bound is tight. Even for Lie algebras of rank 2, computing precisely

when such an inequality is true becomes unrealistically complex. For the purposes of Theorem 5 *any* bound will suffice.

Now let A be an exceptional connected étale algebra in $\mathcal{C}(\mathfrak{sl}_3, k)$ with minimal nontrivial summand (ℓ, m) (i.e. $\ell + m$ is minimal). Using duality $((\ell, m)^* = (m, \ell))$ and rotation of Λ_0 by 120 degrees (tensoring with $(0, k)$), every $(\ell, m) \in \Lambda_0$ is conjugate to one (ℓ', m') such that $m' \leq \ell' \leq k/2$. In what follows, the summands of $(\ell, m)^* \otimes (\ell, m)$ will be computed and these summands are invariant under duality and rotation. We will show $\ell' + m'$ is bounded for such a conjugate. To do so we claim if $m \leq \ell \leq k/2$, then

$$\bigoplus_{i=0}^{\lfloor x/2 \rfloor} (i, i) \subset (m, \ell) \otimes (\ell, m). \quad (38)$$

The set $\bar{\Pi}(m, \ell : \ell, m)$ illustrated in Figure 10. (refer to Section 3.1. for descriptions of the notation and visualization used) is a hexagon (triangle in the degenerate case $m = 0$) with vertex $(0, 0)$ and circumcenter (ℓ, m) . In particular $(i, i) \in \bar{\Pi}(m, \ell : \ell, m)$ for $0 \leq i \leq \lfloor x/2 \rfloor$ (black nodes in Figure 10.). The angles formed between $\bar{\Pi}(m, \ell : \ell, m)$ and T_1, T_2 are 30 degrees when they exist. Therefore, when folded over T_1, T_2 , the edges of $\bar{\Pi}(m, \ell : \ell, m)$ containing $(0, 0)$ are parallel to the line formed by the weights $0 \leq i \leq \lfloor x/2 \rfloor$, implying $\tau_j(\mu) \neq (i, i)$ for any $i \geq 0$ and $j = 1, 2$. Furthermore $m \leq \ell \leq k/2$ ensures there is no contribution from τ_0 to $N_{(m, \ell), (\ell, m)}^{(i, i)}$ for any of the desired summands. Lemma 3 then implies containment (38).

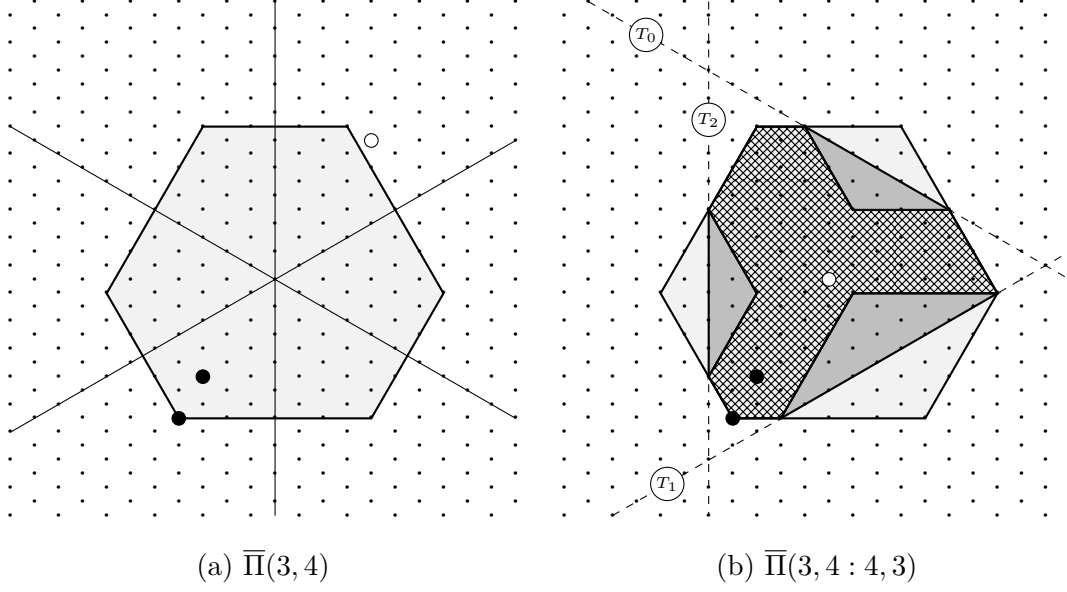

Figure 10.: $(3, 4) \otimes (4, 3) \in \mathcal{C}(\mathfrak{sl}_3, 12)$

By Corollary 4, containment (38) implies

$$\sum_{i=0}^{\lfloor x/2 \rfloor} [i+1]^2 [2(i+1)] < [\ell+1][m+1][\ell+m+2], \quad (39)$$

while applying Corollary 5 to the right-hand side of (39) and Lemma 12 to the left-hand side of (39) (which is applicable since $i \leq x/2$ implies $2(i+1) \leq x+2 < k+3$) yields

$$\sum_{i=0}^{\lfloor x/2 \rfloor} \left(\frac{1}{4}\right) (i+1)^2 \left(\frac{1}{2}\right) 2(i+1) < (\ell+1)(m+1)(\ell+m+2). \quad (40)$$

Furthermore we re-index the left-hand side of (40), and bound each of the factors on the right-hand side of (40) in terms of x to produce

$$\frac{1}{4} \sum_{i=1}^{\lfloor x/2 \rfloor + 1} i^3 < (2x+2)(x+2)(2x+4). \quad (41)$$

Now to eliminate the sum we proceed by parity: if x is even $\lfloor x/2 \rfloor + 1 = x/2 + 1$ and if x is odd $\lfloor x/2 \rfloor + 1 = x/2 + 1/2$. Then using Faulhaber's formula (refer to the introduction of [28] for a brief history and statement of this formula) on the

left-hand side of (41) implies the inequalities

$$\begin{aligned} (x \text{ even}) \quad & \frac{1}{256}(x+2)^2(x+4)^2 < (2x+2)(x+2)(2x+4), \text{ and} \\ (x \text{ odd}) \quad & \frac{1}{256}(x+1)^2(x+3)^2 < (2x+2)(x+2)(2x+4). \end{aligned}$$

The first inequality is true for even x such that $x < 1017$ while the second is true for odd x such that $x < 1021$.

Lemma 8 implies $\theta(\ell, m) = 1$ for our original minimal nontrivial summand of A . One consequence is that (ℓ, m) is contained in the root lattice inside Λ_0 (i.e. $\ell \equiv m \pmod{3}$). Another consequence is that $\theta(\ell', m')$, the twist of its conjugate, is a third root of unity. To see this note that $\theta(0, k)$ is a third root of unity depending on the level k modulo 3 and (ℓ, m) is in the centralizer of the pointed subcategory generated by the simple object $(0, k)$ (refer to the proof of [41, Proposition 3.4.1]). Our claim then follows from the ribbon axioms $\theta((0, k) \otimes (\ell, m)) = \theta(\ell, m)\theta(0, k)$, and $\theta(\ell, m) = \theta(m, \ell)^{-1}$ [17, Definition 8.10.1].

Furthermore, $\theta(\ell', m')$ being a third root of unity forces $(\ell' + 3\ell' + \ell'm' + 3m' + m'^2)/(k+3) \in \mathbb{Z}$ and moreover $(\ell'^2 + 3\ell' + \ell'm' + 3m' + m'^2) - 3 \geq k$. The left-hand side of this inequality is maximized (as a real symmetric function of $\ell', m' \geq 0$) when $\ell' = m'$, which by the above argument can be no larger than $x \leq 1019$. Hence we have $k \leq 3121194$. In summary any exceptional connected étale algebra in $\mathcal{C}(\mathfrak{sl}_3, k)$ must have a minimal summand which is conjugate to (ℓ', m') such that $\ell' + m' \leq 2038$ and must occur at a level $k \leq 3121194$, proving Theorem 5 for $\mathcal{C}(\mathfrak{sl}_3, k)$.

5.3. Proof of Theorem 5: $\mathcal{C}(\mathfrak{so}_5, k)$

Let A be a connected étale algebra in $\mathcal{C}(\mathfrak{so}_5, k)$ with minimal nontrivial summand (ℓ, m) (i.e. $\ell + m$ is minimal) and let $x := \lceil (1/2)(\ell + m) \rceil - 1$, the greatest integer strictly less than the average of ℓ and m . The quantity x is crucial in the remainder of Section 5.3. as summands (s, t) such that $s + t \leq x$ are precisely

those which will satisfy the hypotheses of Lemma 9. We aim to provide an explicit bound on x to subsequently produce a bound on the level k for which such a connected étale algebra can exist.

Lemma 8 implies that (ℓ, m) lies in the root lattice (i.e. m is even). Our proof will be split into four cases (three of the four cases have an argument based on the parity of ℓ), illustrated in Figure 11., based on the relative size of m versus x : $m = 0$ and $\ell < k - 1$, $0 \leq m - 2 \leq x$, $0 \neq \ell \leq x < m - 2$, and $\ell = 0$ with $m < k$. The case $(\ell, m) = (k, 0)$ corresponds to either the standard connected étale algebra $(0, 0) \oplus (k, 0)$ (if k is even; see Example 9) or A has a nontrivial minimal summand covered by another case. In the case $(\ell, m) = (k - 1, 0)$, $\theta(k - 1, 0) = 1$ if and only if $(k + 2)(k - 1)/(2(k + 3))$ is an integer. It can be easily verified that for $k \in \mathbb{Z}_{\geq 1}$, $(k + 2)(k - 1)/(2(k + 3))$ is an integer if and only if $k = 1$. Similarly $\theta(0, k) = 1$ if and only if $k(k + 4)/(k + 3)$ is an integer which is likewise only the case when this integer is zero. Moreover all possible (ℓ, m) will be discussed through these four cases.

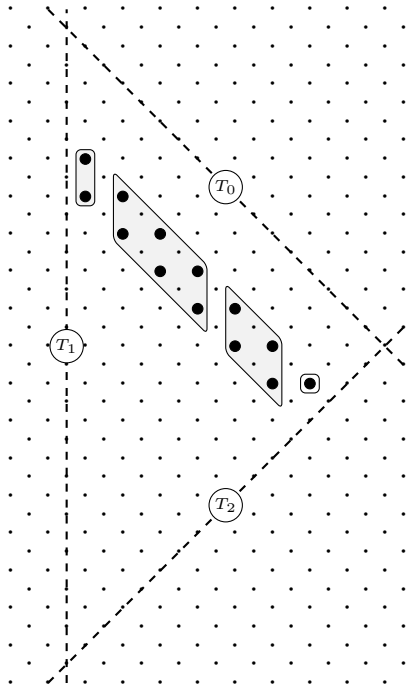

Figure 11.: Possible (ℓ, m) when $k = 14$ and $x = 5$

5.3.1. The Case $m = 0$ and $0 < \ell < k - 1$. Set $\lambda := \ell - x + 2$ so we have $\lambda = x + 4$ if ℓ is even and $\lambda = x + 3$ if ℓ is odd. We claim that if $5 \leq \ell < k - 1$, then

$$(\ell - \lambda, 0) \oplus (\ell - \lambda, 2) \subset (\lambda, 0) \otimes (\ell, 0). \quad (42)$$

The set $\bar{\Pi}(\lambda, 0)$ is a square with vertex $(-\lambda, 0)$ and its three conjugates under the Weyl group. In particular $\Pi(\lambda, 0 : \ell, 0)$ contains $(\ell - \lambda, 0)$ and $(\ell - \lambda, 2)$ provided $\ell \geq 5$. The reflection τ_1 cannot contribute to $N_{(\lambda, 0), (\ell, 0)}^{(\ell - \lambda, 2)}$ or $N_{(\lambda, 0), (\ell, 0)}^{(\ell - \lambda, 0)}$ as $(\lambda, 0)$ does not lie on T_1 , nor does τ_0 contribute by the assumption $\ell < k - 1$. There can be no contribution from τ_2 as $\bar{\Pi}(\lambda, 0 : \ell, 0)$ does not intersect T_2 . Lemma 3 then implies containment (42).

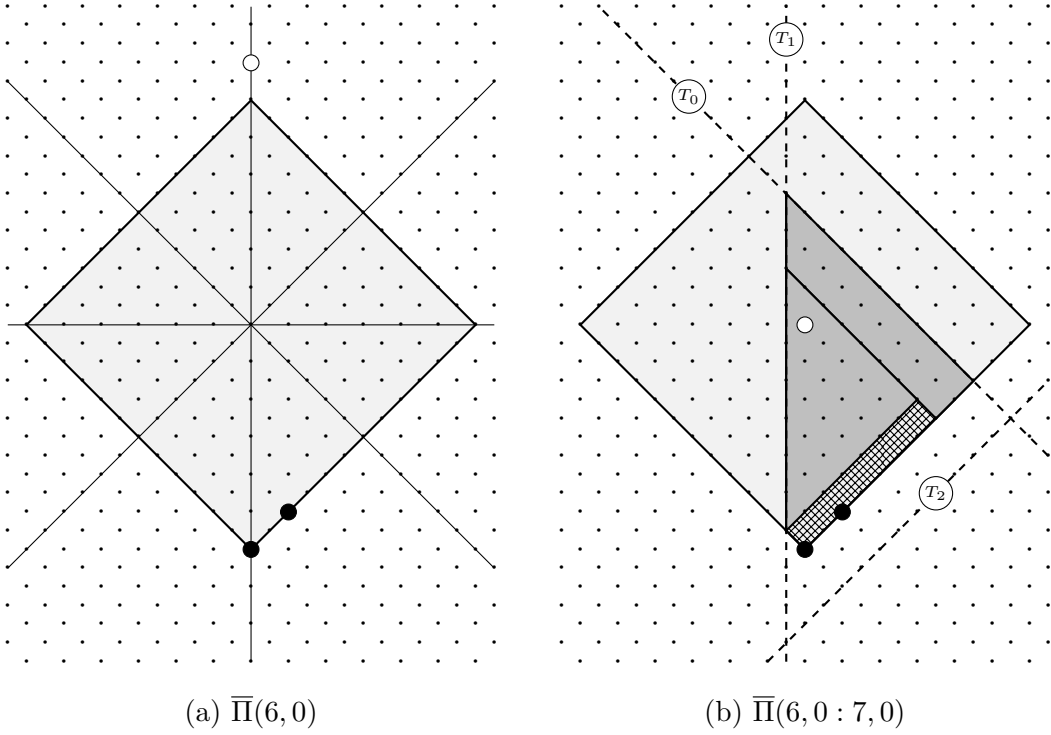

Figure 12.: $(6, 0) \otimes (7, 0) \in \mathcal{C}(\mathfrak{so}_5, 9)$

If ℓ is even, Corollary 4 applied to (42) gives

$$\dim'(x - 2, 0) + \dim'(x - 2, 2) < [2x + 10][2x + 11][2x + 12] \quad (43)$$

$$< ([2x - 2] + 12)([2x - 1] + 12)([2x] + 12) \quad (44)$$

by applying Lemma 11 to the right-hand side of (43). Then expanding the product on the right-hand side of (44) and subtracting the leading term (which is equal to $\dim'(x - 2, 0)$) from both sides yields

$$[3][2x - 2][2x + 4][2x + 1] < 24(6x^2 + 30x + 55) \quad (45)$$

using Corollary 5 on the right-hand side to eliminate the quantum analogs. Moreover, applying Lemma 12 to the left-hand side of (45) (which is justified since $x = (1/2)\ell - 1$ implies $2(2x + 4) \leq 2(k + 3)$) leaves the inequalities

$$(\ell \text{ even}) \quad \frac{3}{4}(x - 1)(2x + 1)(x + 2) < 24(6x^2 + 30x + 55), \text{ and} \quad (46)$$

$$(\ell \text{ odd}) \quad \frac{3}{4}(x - 1)(2x + 1)(x + 2) < 120(x^2 + 4x + 6) \quad (47)$$

repeating the same process for ℓ odd. Inequality (46) is true for even ℓ with $x \leq 98$ and inequality (47) is true for odd ℓ with $x \leq 81$. The former is a weaker bound on $\ell = 2x + 2 \leq 198$, which using $\theta(\ell, 0) = 1$ by Lemma 8 implies $(2\ell^2 + 6\ell)/(4(k + 3)) \in \mathbb{Z}$ and thus $k < (2(198)^2 + 6(198))/4 - 3 = 19896$.

5.3.2. The Case $2 \leq m \leq x + 2$. Set $\lambda := \ell + m - x$ so that $\lambda = x + 1$ when ℓ is odd and $\lambda = x + 2$ if ℓ is even. We claim that for $2 \leq m \leq x + 2$,

$$(x, 0) \oplus (x - 2, 2) \subset (\lambda, 0) \otimes (\ell, m). \quad (48)$$

The set $\bar{\Pi}(\lambda, 0)$ is a square with vertex $(-\lambda, 0)$ and its three conjugates under the Weyl group. From the fact $m \geq 2$ is even, the set $\Pi(\lambda, 0 : \ell, m)$ contains $(x, 0)$ and $(x - 2, 2)$. The square $\bar{\Pi}(\lambda, 0 : \ell, m)$ intersects T_1 at 45 degree angles, thus $(x, 0)$ and $(x - 2, 2)$ lying on this intersecting edge implies there is no contribution to the desired fusion coefficients from τ_1 . Reflection τ_0 could only contribute if (ℓ, m) lies on T_0 , and the assumption $m \leq x + 2$ ensures there is no contribution from τ_2 as well. Lemma 3 then implies containment (48).

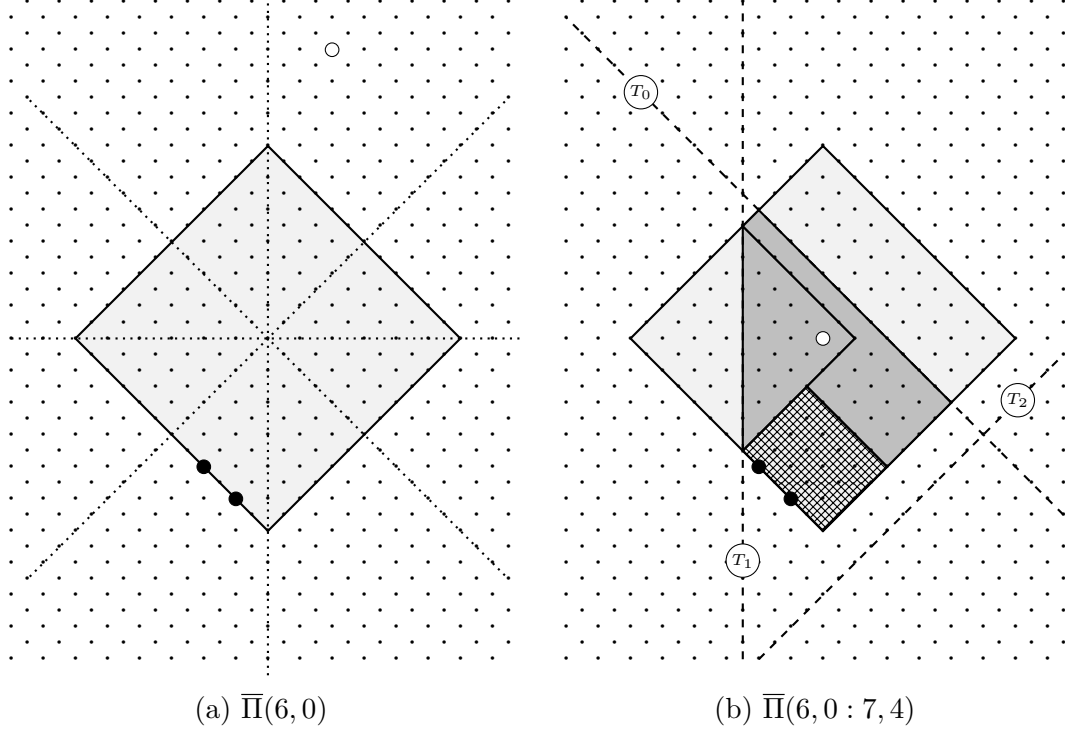

Figure 13.: $(6, 0) \otimes (7, 4) \in \mathcal{C}(\mathfrak{so}_5, 12)$

If ℓ is odd, Corollary 4 applied to (48) gives

$$\dim'(x, 0) + \dim'(x - 2, 2) < [2(x + 2)][2(x + 3)][2x + 5] \quad (49)$$

$$< ([2x + 2] + 2)([2x + 3] + 2)([2x + 4] + 2) \quad (50)$$

using Lemma 11 on the right-hand side of (49). Expanding the product on the right-hand side of (50) and subtracting the leading term (which is equal to $\dim'(x, 0)$) yields

$$[3][2(x - 1)][2x + 1][2(x + 2)] < 24(x + 2)^2 \quad (51)$$

using Corollary 5 on the right-hand side. Applying Lemma 12 to the left-hand side of (51) is justified since $2(2x + 4) = 2(\ell + m + 3) \leq 2(k + 3)$ and thus

$$(\ell \text{ odd}) \quad \frac{3}{4}(x - 1)(2x + 1)(x + 2) < 24(x + 2)^2, \text{ and} \quad (52)$$

$$(\ell \text{ even}) \quad \frac{3}{4}(x - 1)(2x + 1)(x + 2) < 24(2x^2 + 10x + 13). \quad (53)$$

The inequality in (52) is true for odd ℓ with $x \leq 18$ while the inequality in (53) is true for even ℓ with $x \leq 35$. Moreover $2 \leq m \leq 37$, $\ell + m \leq 72$, and therefore $k < 2625$ from Lemma 8 by maximizing $(2\ell^2 + 2\ell m + 6\ell + m^2 + 4m)/4 - 3$ subject to these constraints.

5.3.3. The Case $\ell = 0$ and $m < k$. We claim for $m \geq 4$,

$$\bigoplus_{i=0}^{x-1} (i, 0) \subset (0, m) \otimes (0, m). \quad (54)$$

The set $\bar{\Pi}(0, m)$ is a square with vertex $(0, -m)$ and its three conjugates under the Weyl group. In particular $\Pi(0, m : 0, m)$ contains $(i, 0)$ for $0 \leq i \leq x - 1$. The angles formed between T_0, T_2 and $\bar{\Pi}(0, m : 0, m)$ are 45 degrees, ensuring there is no contribution to the desired fusion coefficients from τ_0, τ_2 ; $\bar{\Pi}(0, m : 0, m)$ does not intersect T_1 so there is no contribution from τ_1 either. Lemma 3 then implies containment (54).

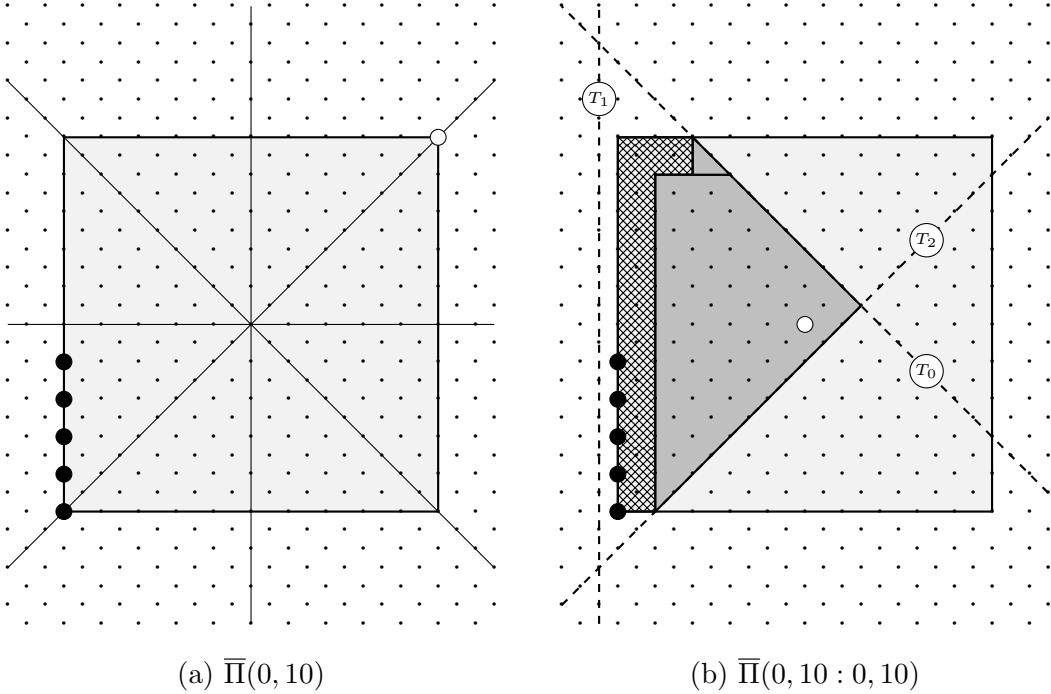

Figure 14.: $(0, 10) \otimes (0, 10) \in \mathcal{C}(\mathfrak{so}_5, 11)$

Corollary 4 applied to (54) gives

$$\sum_{i=0}^{x-1} [2(i+1)][2(i+2)][2i+3] < [2][m+1][2(m+2)][m+3] \quad (55)$$

$$\Rightarrow \sum_{i=0}^{x-1} (i+1)(i+2)(i+3/2) < 4(m+1)(m+2)(m+3) \quad (56)$$

by applying Corollary 5 to the right-hand side of (55) and Lemma 12 to the left-hand side of (55). Lemma 12 applies since m even implies $2(2x+2) = 2(m+4) < 2(k+3)$. Now we rewrite the right-hand side of (56) in terms of x and re-index the left-hand sum, observing each factor on the left-hand side of (56) is greater than i to yield

$$\sum_{i=1}^x i^3 < 4(2x+3)(2x+4)(2x+5). \quad (57)$$

Using Faulhaber's formula [28] on the left-hand side of (57) produces

$$\frac{1}{4}x^2(x+1)^2 < 4(2x+3)(2x+4)(2x+5)$$

which is true for $x \leq 131$, and thus $2x+2 = m \leq 264$. From Lemma 8 we have $\theta(0, m) = 1$, which implies $(m^2 + 4m)/(4(k+3)) \in \mathbb{Z}$ and thus $k < (264^2 + 4 \cdot 264)/4 - 3 = 17685$.

5.3.4. The Case $0 \neq \ell \leq x < m - 2$. Set $\lambda := \ell + m - x + 1$ so that $\lambda = x + 3$ if ℓ is even, and $\lambda = x + 2$ if ℓ is odd. We claim if $0 \neq \ell \leq x < m - 2$, then

$$(\ell + 1, m - \lambda) \oplus (\ell - 1, m - \lambda + 2) \subset (0, \lambda) \otimes (\ell, m). \quad (58)$$

The set $\overline{\Pi}(0, \lambda)$ is a square with vertex $(0, -\lambda)$ and its seven conjugates under the Weyl group. In particular $\Pi(0, \lambda : \ell, m)$ contains $(\ell + 1, m - \lambda)$ and $(\ell - 1, m - \lambda + 2)$ since $x + 2 < m$. The angles formed by $\overline{\Pi}(0, \lambda : \ell, m)$ and T_2 are 45 degrees when they exist which implies there is no contribution to the desired fusion coefficients from τ_2 , while τ_0 cannot contribute because (ℓ, m) does not lie on T_0 . Lastly note

that $\bar{\Pi}(0, \lambda : \ell, m)$ does not intersect T_1 since $x + 2 < m$ so there can be no contribution from τ_1 either. Lemma 3 then implies containment (58).

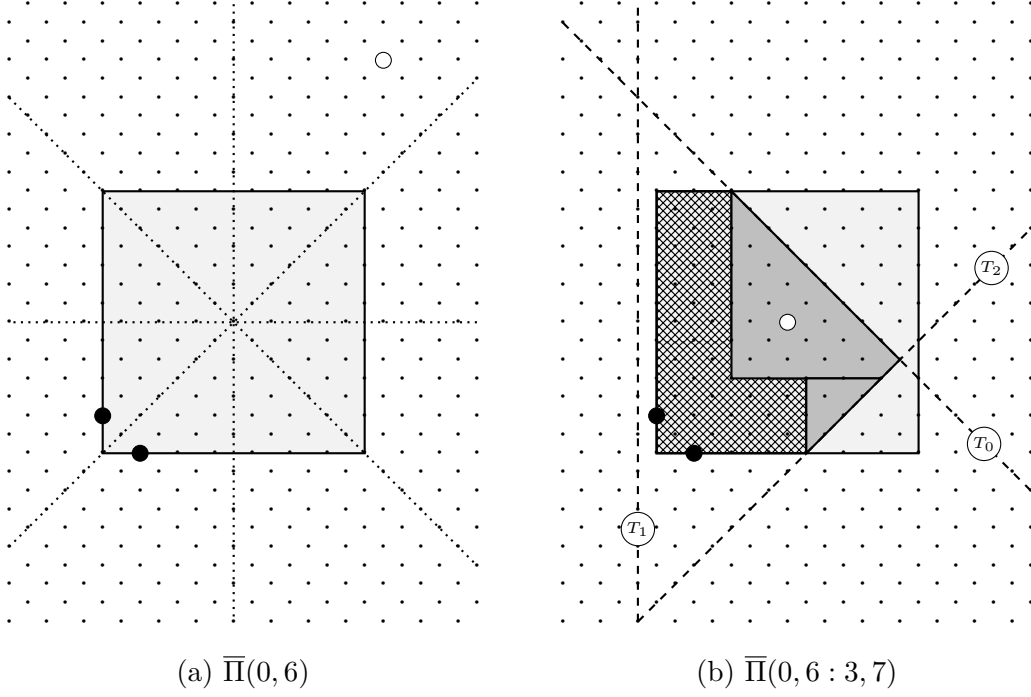

Figure 15.: $(0, 6) \otimes (3, 7) \in \mathcal{C}(\mathfrak{so}_5, 10)$

Now notice that $(\ell + 1, m - \lambda)$ and $(\ell - 1, m - \lambda + 2)$ are contained in the set of weights $(s, t) \in \Lambda_0$ such that $s + t = x$.

Lemma 13. *If $0 \leq x < k/2$, $\dim'(0, x) \leq \dim'(s, x - s)$ for all $0 \leq s \leq x$.*

Proof. With $\kappa := \pi/(2(k + 3))$, define $f(s) := \sin((x - s + 1)\kappa) \sin((x + s + 3)\kappa)$ and $g(s) := \sin((2s + 2)\kappa)$ so that

$$\dim'(s, x - s) = \sin^{-4}(\kappa) \sin(2(x + 2)\kappa) f(s)g(s)$$

as a real function of $s \in [0, x]$ with the constant $\sin^{-4}(\kappa) \sin(2(x + 2)\kappa) > 0$ since κ and $2(x + 2)\kappa$ are in the interval $(0, \pi/2)$ for $0 \leq x < k/2$. We will prove our claim by showing that $(d^2/ds^2) \dim'(s, x - s) < 0$ on $[0, x]$ and $\dim'(0, x) \leq \dim'(x, 0)$. It can be easily verified that $f(s) > 0$, $g(s) > 0$, $g'(s) > 0$ and $g''(s) < 0$ for $s \in [0, x]$, so we will explicitly compute with $\alpha := x - s + 1$ and $\beta := x + s + 3$ for

brevity:

$$\begin{aligned}
f'(s) &= \kappa(\sin(\alpha\kappa) \cos(\beta\kappa) - \cos(\alpha\kappa) \sin(\beta\kappa)) \\
&= -\kappa \sin(2(s+2)\kappa) \\
\Rightarrow f''(s) &= -2\kappa^2 \cos(2(s+2)\kappa).
\end{aligned}$$

The above computations imply $f'(s) < 0$ and $f''(s) < 0$ for $s \in [0, x]$. Using the product rule twice implies $(fg)''(s) < 0$ and moreover $(d^2/ds^2) \dim'(s, x-s) < 0$ since these functions differ by a positive constant factor.

Lastly we need to verify $\dim'(0, x) \leq \dim'(x, 0)$, or that

$$\begin{aligned}
[2][x+1][x+3] &\leq [2x+2][2x+3] \\
\Leftrightarrow [x+1][x+3] &\leq \frac{[2x+2]}{[2]}[2x+3].
\end{aligned}$$

Note that

$$\begin{aligned}
\frac{[2x+2]}{[2]} &= \frac{q^{x+1} + q^{-(x+1)}}{q + q^{-1}} [x+1] \\
&= \frac{\cos\left(\frac{(x+1)\pi}{2(k+3)}\right)}{\cos\left(\frac{\pi}{2(k+3)}\right)} [x+1] \\
&\geq \frac{\sqrt{2}}{2} [x+1],
\end{aligned}$$

because $x+1 < (1/2)(k+3)$. Moreover we need only prove $[x+3] \leq (\sqrt{2}/2)[2x+3]$. This inequality is always true because $x+3$ and $2x+3$ are in the interval $(0, k+3)$ and the function $[n] = \sin(n\pi/(2(k+3)))/\sin(\pi/(2(k+3)))$ is strictly increasing for $n \in (0, k+3)$. \square

Hence when ℓ is even, Lemma 13 and Corollary 4 applied to (58) implies

$$\begin{aligned} \dim'(0, x) + \dim'(0, x) &\leq \dim'(\ell + 1, m - \lambda) + \dim'(\ell - 1, m - \lambda + 2) \\ &\leq \dim'(0, x + 3) \\ \Rightarrow \dim'(0, x) + \dim'(0, x) &< [2]([x + 1] + 3)([2x + 4] + 6)([x + 3] + 3) \end{aligned} \quad (59)$$

by applying Lemma 11 to the right-hand side of (59). All terms in the inequality in (59) have a factor of $[2]$ which we divide out before expanding the product on the right-hand side of (59) and subtracting the leading term (equal to $\dim'(0, x)$) to yield

$$\frac{1}{4}(x + 1)(x + 2)(x + 3) < 6(3x^2 + 21x + 38). \quad (60)$$

Corollary 5 was applied eliminate the quantum analogs on the right-hand side of (60) and Lemma 12 was applied to eliminate the quantum analogs on the left-hand side, which is applicable since $4(x + 2) < 4(k + 3)$ since $x < k/2$. Inequality (60) is true for $x \leq 72$, which implies $0 < \ell \leq 72$ and $74 < m \leq 145$. Moreover Lemma 8 implies $k < 13319$ by maximizing $(2\ell^2 + 2\ell m + 6\ell + m^2 + 4m)/4 - 3$ subject to these constraints. Repeating the above with ℓ odd only changes the right-hand side of (60) to $12(x + 3)^2$, which clearly produces a more restrictive bound on x .

5.4. Proof of Theorem 5: $\mathcal{C}(\mathfrak{g}_2, k)$

Let A be a connected étale algebra in $\mathcal{C}(\mathfrak{g}_2, k)$ with minimal nontrivial summand (ℓ, m) (i.e. $\ell + (3/2)m$ is minimal) and fix $x := \lceil (1/2)(\ell + (3/2)m) \rceil - 1$; the value x is the greatest integer n such that $(n, 0)$ satisfies the hypotheses of Lemma 9. Similarly one can set $y := \lceil (1/2)((2/3)\ell + m) \rceil - 1$; the value y is the greatest integer n such that $(0, n)$ satisfies the hypotheses of Lemma 9. The proof of Theorem 5 will be split into four (clearly exhaustive) cases, illustrated by example in Figure 16., with varying numbers of subcases for a fixed x : $0 \leq \ell \leq 2$, $3 \leq \ell \leq x + 3$, $x + 3 < \ell$ with $m \neq 0$, and $m = 0$.

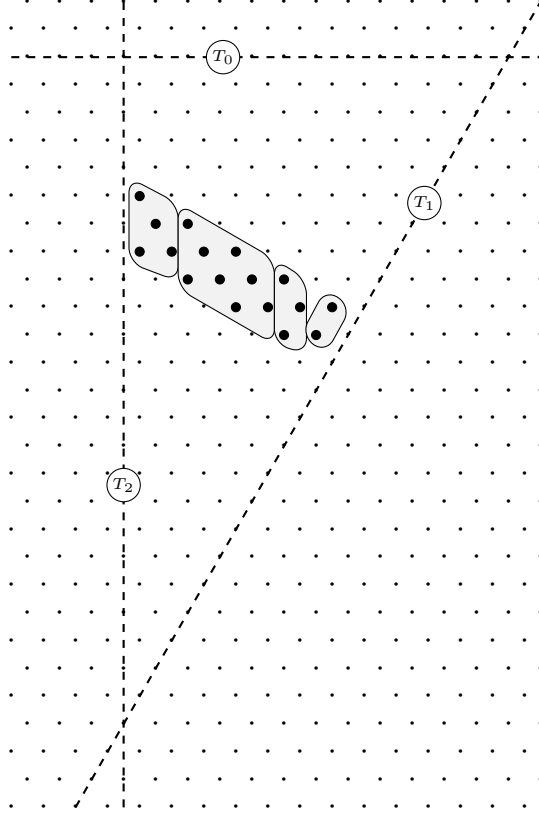

Figure 16.: Possible (ℓ, m) when $k = 20$ and $x = 5$

5.4.1. The Case $0 \leq \ell \leq 2$.

The Subcase $\ell = 0$. We will employ the same strategy as Section 5.3.1.. Recall $y = \lceil m/2 \rceil - 1$ if $\ell = 0$ and set $\lambda := m - y + 1$ so that $\lambda = y + 3$ if m is even, and $\lambda = y + 2$ if m is odd. We claim for $4 < m \leq k/2$,

$$(0, y - 1) \oplus (3, y - 2) \subset (0, \lambda) \otimes (0, m). \quad (61)$$

The set $\bar{\Pi}(0, \lambda)$, illustrated by example in Figure 17., (refer to Section 3.1. for descriptions of the notation and visualization used), is a hexagon with vertex $(0, -\lambda)$ and its five conjugates under the Weyl group. In particular $\Pi(0, \lambda : 0, m)$ contains $(0, y - 1)$ and $(3, y - 2)$ since $m > 4$. There is no contribution to $N_{(0, \lambda), (0, m)}^{(0, y - 1)}$ or $N_{(0, \lambda), (0, m)}^{(3, y - 2)}$ from τ_2 because the angles formed by $\bar{\Pi}(0, \lambda : 0, m)$ and T_2 are 60 degrees and there is no contribution from τ_1 because the angles formed by $\bar{\Pi}(0, \lambda : 0, m)$ and T_1 (when they exist) are 30 degrees. There is no contribution

from τ_0 because $(0, m)$ does not lie on T_0 . Lemma 3 then implies containment (61).

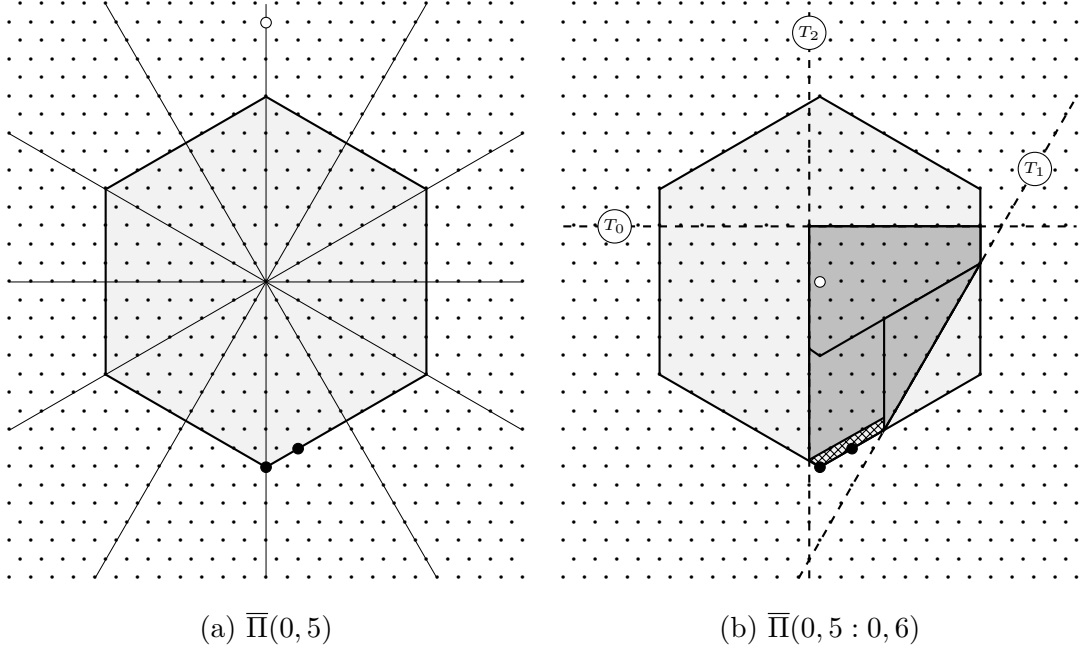

Figure 17.: $(0, 5) \otimes (0, 6) \in \mathcal{C}(\mathfrak{g}_2, 18)$

If m is even, Corollary 4 applied to (61) gives

$$\dim'(0, y - 1) + \dim'(3, y - 2) \tag{62}$$

$$\leq [3y + 12][3y + 15][6y + 27][3y + 13][3y + 14] \tag{63}$$

$$\leq ([3y] + 12)([3y + 3] + 12)([6y + 3] + 24)([3y + 1] + 12)([3y + 2] + 12) \tag{64}$$

where (64) is gained by applying Corollary 5 to (63). Expanding the product in (64) and subtracting the leading term (equal to $\dim'(0, y - 1)$) yields

$$\frac{27}{8}(y - 1)(y + 3)(y + 1)(3y + 1)(3y + 5) \leq 3240(3y^4 + 30y^3 + 136y^2 + 305y + 273)$$

by applying Lemma 12 to the factors of $\dim'(3, y - 2)$ in (62), which is true for even m with $y \leq 324$ or likewise $m \leq 650$. From Lemma 8, $\theta(0, m) = 1$ which implies $(3m^2 + 9m)/(3(k + 4)) \in \mathbb{Z}$ and moreover $k \leq (1/3)(3(650)^2 + 9(650)) - 4 = 424446$.

By repeating the above argument with m odd we obtain the inequality

$$\frac{27}{8}(y-1)(y+3)(y+1)(3y+1)(3y+5) < 810(9y^4 + 72y^3 + 255y^2 + 444y + 308)$$

which is true for $y \leq 242$ which evidently yields a stricter bound on k .

The Subcase $\ell = 1$. The strategy is identical to Section 5.4.1., except with $\lambda := m - y + 1$ we claim

$$(0, y-1) \oplus (3, y-2) \subset (1, \lambda) \otimes (0, m),$$

and we omit the redundant arguments for both this containment and to produce the following inequalities, based on m being even or odd, respectively:

$$\begin{aligned} \frac{27}{32}y(y+1)(2y+1)(3y+1)(3y+2) &\leq 324(54y^4 + 613y^3 + 2861y^2 + \beta_1y + \beta_2) \\ \frac{27}{32}y(y+1)(2y+1)(3y+1)(3y+2) &\leq 1620(y+3)(9y^3 + 65y^2 + 183y + 191) \end{aligned}$$

where $\beta_1 = 6427$ and $\beta_2 = 5725$ for display purposes. The first inequality is true for even m with $y \leq 1160$ and the second for odd m with $y \leq 967$, hence $m \leq 2322$ and moreover $k \leq (1^2 + 3(1)(2322) + 5(1) + 3(2322)^2 + 9(2322))/3 - 4 = 5400970$.

The Subcase $\ell = 2$. The strategy is identical to Section 5.4.1., except with $\lambda := m - y + 1$ we claim

$$(0, y-1) \oplus (3, y-2) \subset (2, \lambda) \otimes (0, m),$$

and so we omit the redundant argument to produce the following inequalities, based on m being even or odd, respectively:

$$\begin{aligned} \frac{27}{32}y(y+1)(2y+1)(3y+1)(3y+2) &\leq 81(399y^4 + 5171y^3 + \beta_1y^2 + \beta_2y + \beta_3) \\ \frac{27}{32}y(y+1)(2y+1)(3y+1)(3y+2) &\leq 2835(y+3)(9y^3 + 73y^2 + 234y + 278) \end{aligned}$$

where $\beta_1 = 28239$, $\beta_2 = 74821$, and $\beta_3 = 78570$ for display purposes. The first inequality is true for even m with $y \leq 2138$ and the second for odd m with $y \leq 1688$, hence $m \leq 4272$ and moreover $k \leq (2^2 + 3(2)(4272) + 5(2) + 3(4272)^2 + 9(4272))/3 - 4 < 18271135$.

5.4.2. The Case $m = 0$. Recall $x = \lceil \ell/2 \rceil - 1$ if $m = 0$. Set $\lambda := \ell - x + 1$ so that $\lambda = x + 3$ if ℓ is even and $\lambda = x + 2$ if ℓ is odd. We claim that for $4 < \ell \leq k$,

$$(x - 1, 0) \oplus (x - 2, 1) \subset (\lambda, 0) \otimes (\ell, 0). \quad (65)$$

The set $\bar{\Pi}(\lambda, 0)$, illustrated by example in Figure 18., is a hexagon with vertex $(-\lambda, 0)$ and its five conjugates under the Weyl group. In particular $\bar{\Pi}(\lambda, 0 : \ell, 0)$ contains $(x - 1, 0)$ and $(x - 2, 1)$ provided $\ell > 4$. The angles formed by $\bar{\Pi}(\lambda, 0 : \ell, 0)$ and T_1 are 30 degrees and the angles formed by $\bar{\Pi}(\lambda, 0 : \ell, 0)$ and T_0, T_2 are 60 degrees, ensuring there can be no contribution from τ_0, τ_1, τ_2 . Lemma 3 then implies containment (65).

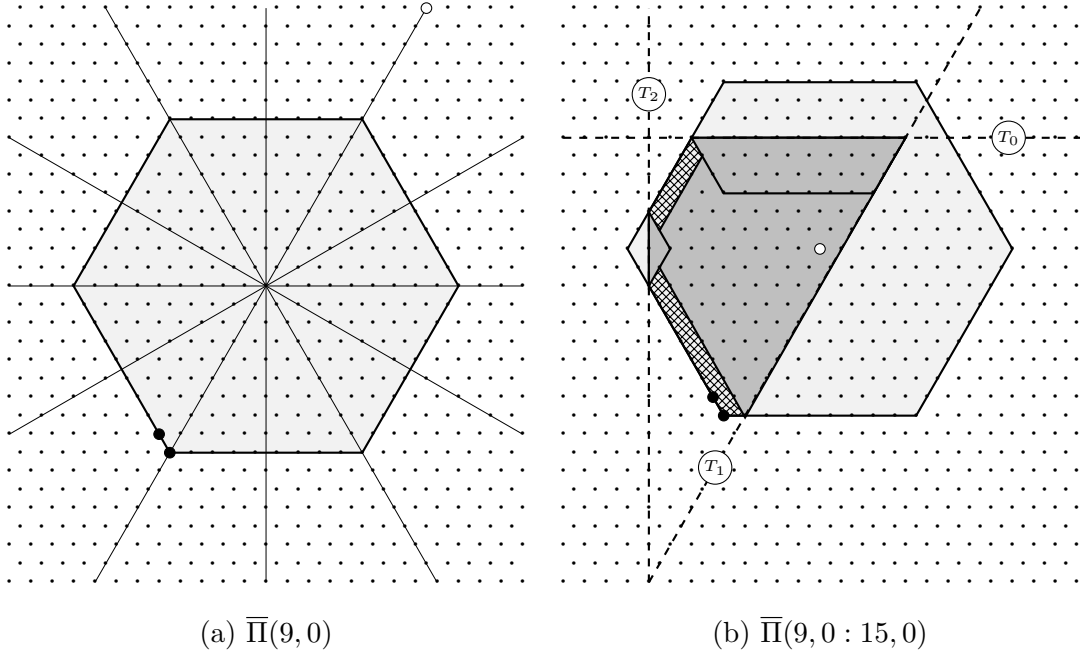

Figure 18.: $(9, 0) \otimes (15, 0) \in \mathcal{C}(\mathfrak{g}_2, 20)$

If m is even, Corollary 4 applied to (65) gives

$$\dim'(x-1, 0) + \dim'(x-2, 1) \tag{66}$$

$$\leq [x+4][3][3x+15][3x+18][x+7][2x+11] \tag{67}$$

$$\leq ([x]+4)[3]([3x+3]+12)([3x+6]+12)([x+3]+4)([2x+3]+8) \tag{68}$$

where (68) is gained by applying Corollary 5 to (67). Expanding the product in (68) and subtracting the leading term (which is equal to $\dim'(x-1, 0)$) yields

$$\frac{27}{16}(x-1)(x+2)(x+3)(x+5)(x+2) \leq 1080(x^4 + 14x^3 + 80x^2 + 217x + 231) \tag{69}$$

by applying Lemma 12 to the factors of $\dim'(x-2, 1)$ in (66), which is true for even $x \leq 642$ or likewise $\ell \leq 1286$. From Lemma 8 we know $\theta(\ell, 0) = 1$ which implies $(\ell^2 + 5\ell)/(3(k+4)) \in \mathbb{Z}$ and with the proven bound on ℓ , $k \leq (1/3)((1286)^2 + 5(1286)) - 4 = 1660214/3 < 553405$.

If m is odd, the above process yields the inequality

$$\frac{27}{16}(x-1)(x+2)(x+3)(x+5)(x+2) \leq 810(x+3)^2(x^2 + 6x + 12)$$

which is true for $x \leq 481$ which evidently yields a stricter bound on k .

5.4.3. The Case $3 \leq \ell \leq x+3$. We will employ the same strategy as Section 5.3.2. but the proof is necessarily split based on ℓ modulo 3.

The Subcase $\ell \equiv 0 \pmod{3}$. Recall $y = \lceil (1/2)((2/3)\ell + m) \rceil - 1$ and set $\lambda := (2/3)\ell + m - y$ so that $\lambda = y+2$ if m is even and $\lambda = y+1$ if m is odd. We claim

$$(0, y) \oplus (3, y-2) \subset (0, \lambda) \otimes (\ell, m). \tag{70}$$

The set $\overline{\Pi}(0, \lambda)$, illustrated by example in Figure 19., is a hexagon with vertex $(0, -\lambda)$ and its five conjugates under the Weyl group. In particular $\Pi(0, \lambda : \ell, m)$

contains $(0, y)$ and $(3, y - 2)$. To see this, $\Pi(0, \lambda : \ell, m)$ contains more generally all $(\ell - 3i, m - \lambda + 2i)$ for all $0 \leq i \leq (1/3)\ell$. The angles formed by $\bar{\Pi}(0, \lambda : \ell, m)$ and T_1 are 30 degrees and the angles formed by $\bar{\Pi}(0, \lambda : \ell, m)$ and T_2 are 60 degrees, implying there are no contributions from τ_1, τ_2 . The angles formed by $\bar{\Pi}(0, \lambda : \ell, m)$ and T_0 are 90 (or 30) degrees when they exist, but since $(0, m)$ does not lie on T_0 there is no contribution from τ_0 . Lemma 3 then implies containment (70).

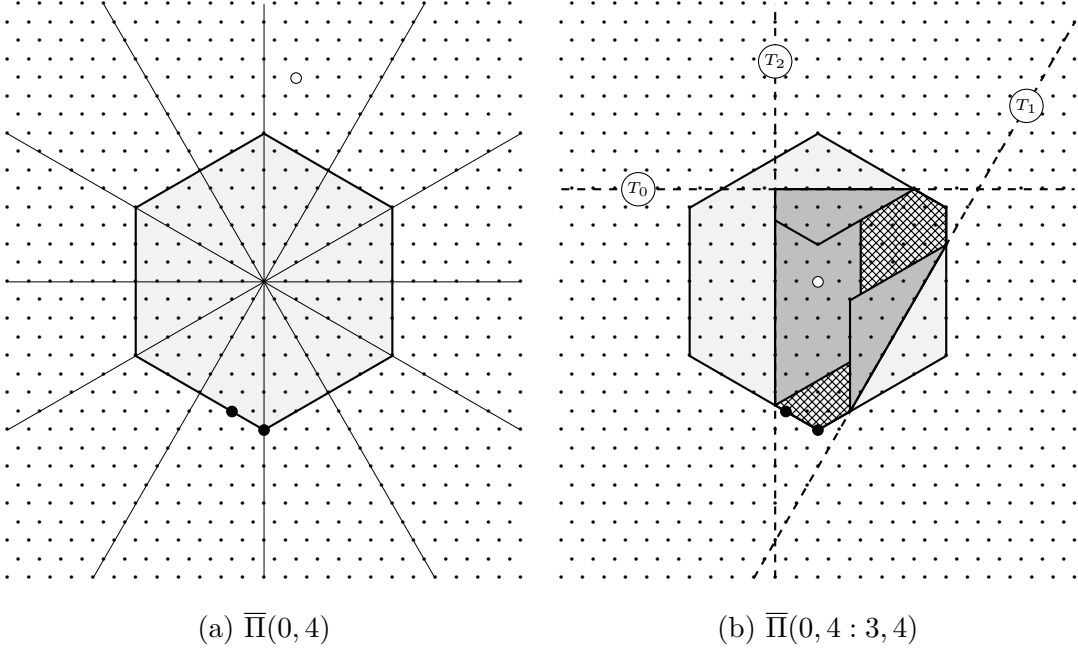

Figure 19.: $(0, 4) \otimes (3, 4) \in \mathcal{C}(\mathfrak{g}_2, 15)$

If m is even, Corollary 4 applied to (70) gives

$$\dim'(0, y) + \dim'(3, y - 2) \tag{71}$$

$$\leq [3y + 9][3y + 12][6y + 21][3y + 10][3y + 11] \tag{72}$$

$$\leq ([3y + 3] + 6)([3y + 6] + 6)([6y + 9] + 18)([3y + 4] + 6)([3y + 5] + 6) \tag{73}$$

by applying Corollary 5 to (72). Expanding the product in (73) and subtracting the leading term (equal to $\dim'(0, y)$) yields

$$\frac{27}{8}(y - 1)(y + 3)(y + 1)(3y + 1)(3y + 5) \leq 1620(y^2 + 5y + 8)(3y^2 + 15y + 19) \tag{74}$$

which is true for even $(2/3)\ell + m$ with $y \leq 164$. This bound implies $\ell + (3/2)m \leq 495$. From Lemma 8 we know $\theta(\ell, m) = 1$ which implies $k \leq (1/3)(\ell^2 + 3\ell m + 5\ell + 3m^2 + 9m) - 4$; and for $\ell + (3/2)m \leq 495$ we have $k \leq 109886$. As in Sections 5.4.1. and 5.4.2., the case in which $\ell + (3/2)m$ is odd leads to a stricter bound on k by this method.

The Subcase $\ell \equiv 1 \pmod{3}$. With $y = \lceil (1/2)((2/3)\ell + m) \rceil - 1$, we set $\lambda := (2/3)(\ell - 1) + m - y$. This implies $\lambda = y$ if m is even and $\lambda = y + 1$ if m is odd. We claim

$$(0, y) \oplus (3, y - 2) \subset (1, \lambda) \otimes (\ell, m) \quad (75)$$

and we omit the argument for this containment as it is identical to that of Section 5.4.3..

If m is odd, Corollary 4 applied to (75) gives

$$\dim'(0, y) + \dim'(3, y - 2) \quad (76)$$

$$\leq [2][3y + 6][3y + 12][6y + 18][3y + 8][3y + 10] \quad (77)$$

$$\leq [4]([3y - 3] + 9)([3y + 9] + 3)([6y + 6] + 12)([3y + 1] + 7)([3y + 5] + 5) \quad (78)$$

by applying Corollary 5 to the right-hand side of (77). Expanding the product on the right-hand side of (78) and subtracting the leading term (equal to $\dim'(0, y)$) yields

$$\frac{27}{8}(y-1)(y+3)(y+1)(3y+1)(3y+5) \leq 648(y+3)(12y^3 - 20y^2 - 282y - 425) \quad (79)$$

which is true for $y \leq 252$. Hence we have $(2/3)\ell + m \leq 1288$ and furthermore $\ell + (3/2)m \leq 1933$. The level k is bounded under these constraints by $k \leq 1664094$. As in Sections 5.4.1. and 5.4.2., the case in which m is even leads to a stricter bound on k by this method.

The Subcase $\ell \equiv 2 \pmod{3}$. With $y = \lceil (1/2)((2/3)\ell + m) \rceil - 1$, we set $\lambda := (2/3)(\ell - 2) + m - y$. This implies $\lambda = y$ if m is even and $\lambda = y - 1$ if m is odd. We claim

$$(0, y) \oplus (3, y) \subset (2, \lambda) \otimes (\ell, m) \quad (80)$$

and we omit the argument for this containment as it is identical to that of Section 5.4.3..

If m is even, Corollary 4 applied to (80) gives

$$\dim'(0, y) + \dim'(3, y - 2) \quad (81)$$

$$\leq [3][3y + 3][3y + 12][6y + 15][3y + 6][3y + 9] \quad (82)$$

$$\leq [4]([3y - 3] + 6)([3y + 9] + 3)([6y + 6] + 9)([3y + 1] + 5)([3y + 5] + 4) \quad (83)$$

by applying Corollary 5 to (77). Expanding the product in (78) and subtracting the leading term (which is equal to $\dim(0, x)$) yields

$$\frac{27}{8}(y - 1)(y + 3)(y + 1)(3y + 1)(3y + 5) \leq 540(y + 3)(y + 1)(27y^2 + 88y + 74) \quad (84)$$

which is true for $y \leq 962$, hence $(2/3)\ell + m \leq 1926$ and moreover $\ell + (3/2)m \leq 2889$. This produces a bound of $k \leq 3715250$. As in Sections 5.4.1. and 5.4.2., the case in which m is odd leads to a stricter bound on k by this method.

5.4.4. The Case $x + 3 < \ell$ and $m \neq 0$. We will employ a similar strategy to Section 5.3.4.. We first claim that if $x + 3 < \ell$, then for some $x + 1 \leq \lambda \leq x + 3$, $(\lambda, 0) \otimes (\ell, m)$ contains two summands (s, t) such that $s + (3/2)t = x$, depending on the parity of ℓ and remainder of m modulo 4. We will provide proof of this claim in the most extreme case ℓ is even and $4 \mid m$, using $\lambda = x + 3$, leaving the other near identical cases to the reader. The only changes in each case are due to the slight differences caused by the ceiling function in the definition of x . Note that under our current assumptions $x = (1/2)\ell + (3/4)m - 1$.

The set $\bar{\Pi}(\lambda, 0)$, illustrated by example in Figure 20., is a hexagon with vertex

$(-\lambda, 0)$ and its five conjugates under the Weyl group. In particular $\Pi(\lambda, 0 : \ell, m)$ contains $(\ell - \lambda - 2, m + 2)$ and $(\ell - \lambda + 4, m - 2)$. The angles formed by $\bar{\Pi}(\lambda, 0 : \ell, m)$ and T_1 are 30 degrees and the angles formed by $\bar{\Pi}(\lambda, 0 : \ell, 0)$ and T_0, T_2 are 60 degrees, ensuring there can be no contribution from τ_0, τ_1, τ_2 . Lemma 3 then implies the fusion coefficients $N_{(\lambda, 0), (\ell, m)}^{(\ell - \lambda - 2, m + 2)}$ and $N_{(\lambda, 0), (\ell, m)}^{(\ell - \lambda + 4, m - 2)}$ are nonzero as desired, provided $(\ell - \lambda + 2, m - 2)$ and $(\ell - \lambda - 2, m + 2)$ are in Λ_0 which is assured since $\ell > x + 3$ and $m \geq 4$ under our current assumptions. It remains to note that since ℓ is even and $4 \mid m$, then

$$\begin{aligned} (\ell - \lambda + 4) + \frac{3}{2}(m - 2) &= 2 \left(\frac{1}{2}\ell + \frac{3}{4}m - 1 \right) + 3 - \lambda \\ &= 2x + 3 - (x + 3) = x \end{aligned}$$

as desired; similarly $(\ell - \lambda - 2) + (3/2)(m + 2) = x$.

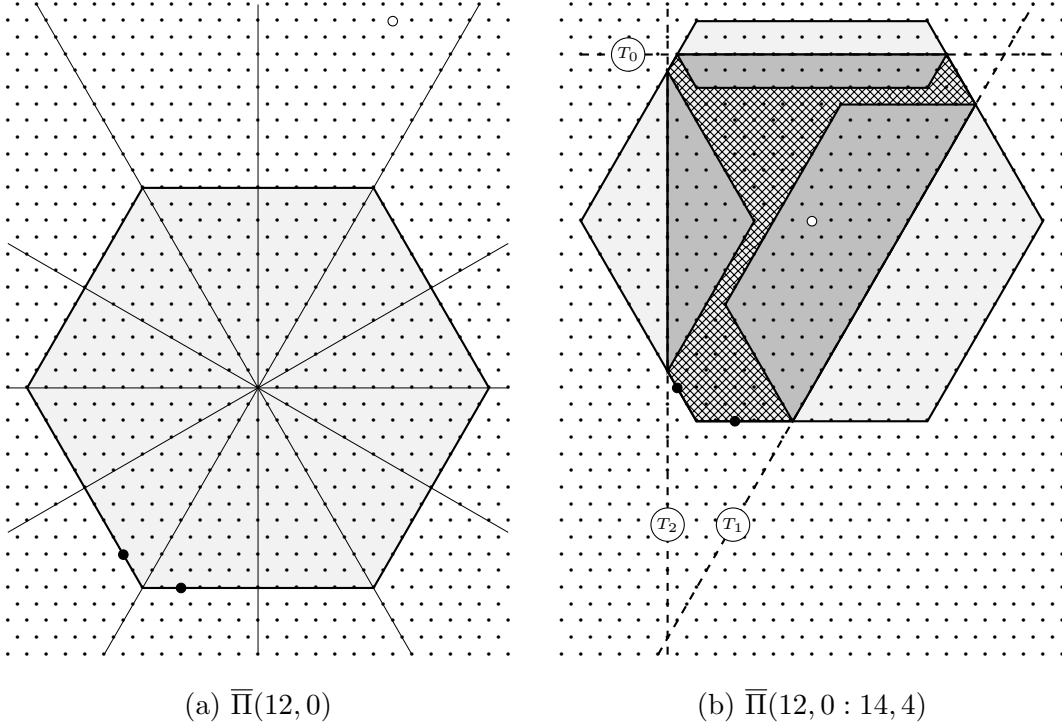

Figure 20.: $(12, 0) \otimes (14, 4) \in \mathcal{C}(\mathfrak{g}_2, 24)$

Now because $\dim'(x, 0) \leq \dim'(s, t)$ over all (s, t) such that $s + (3/2)t = x$ by

the same reasoning that lead to Lemma 13, Corollary 4 implies

$$\dim'(x, 0) + \dim'(x, 0) \tag{85}$$

$$\leq [x + 4][3][3x + 15][3x + 18][x + 7][2x + 11] \tag{86}$$

$$< ([x + 1] + 3)[3]([3x + 6] + 9)([3x + 9] + 9)([x + 4] + 3)([2x + 5] + 6) \tag{87}$$

by applying Corollary 5 to (86). Expanding the product in (87) and subtracting the leading term (equal to $\dim'(x, 0)$) from both sides of this equality yields

$$\frac{27}{64}(x + 1)(x + 2)(x + 3)(x + 4)(2x + 5) < 810(x + 4)^2(x^2 + 8x + 19) \tag{88}$$

by applying Lemma 12 to the factors on the left-hand side of (88) and Corollary 5 to the factors on the right-hand side of (88). The inequality in (88) is true for $x \leq 963$. Moreover $\ell \leq 1926$ and $m \leq 963$, therefore $k \leq (1/3)(\ell^2 + 3\ell m + 5\ell + 3m^2 + 9m) - 4$ is maximized within these bounds at $k \leq 4023089$.

REFERENCES CITED

- [1] Henning Haahr Andersen and Jan Paradowski. Fusion categories arising from semisimple Lie algebras. *Communications in Mathematical Physics*, (169):563–588, 1995.
- [2] F. A. Bais and Peter Bouwknegt. A classification of subgroup truncations of the bosonic string. *Nuclear Physics*, 279:561–570, 1987.
- [3] Bojko Bakalov and Jr. Alexander Kirillov. *Lectures on Tensor Categories and Modular Functors*, volume 21 of *University Lecture Series*. American Mathematical Society, 2001.
- [4] Jens Böckenhauer, David E. Evans, and Yasuyuki Kawahigashi. On α -induction, chiral generators and modular invariants for subfactors. *Communications in Mathematical Physics*, 208(2):429–487, 1999.
- [5] Jens Böckenhauer, David E. Evans, and Yasuyuki Kawahigashi. Chiral structure of modular invariants for subfactors. *Communications in Mathematical Physics*, 210(3):733–784, 2000.
- [6] Paul Bruillard, Siu-Hung Ng, Eric C. Rowell, and Zhenghan Wang. On classification of modular categories by rank. *International Mathematics Research Notices*, 2016.
- [7] Alfredo Cappelli, Claude Itzykson, and J. B. Zuber. The A-D-E classification of minimal and $A_1^{(1)}$ conformal invariant theories. *Communications in Mathematical Physics*, 113(1):1–26, 1987.
- [8] Robert Coquereaux, Rochdi Rais, and El Hassan Tahri. Exceptional quantum subgroups for the rank two Lie algebras B_2 and G_2 . *Journal of Mathematical Physics*, 51(092302), 2010.
- [9] Robert Coquereaux and Gil Schieber. Quantum symmetries for exceptional $SU(4)$ modular invariants associated with conformal embeddings. *Symmetry, Integrability and Geometry: Methods and Applications*, 5(044), 2009.
- [10] Alexei Davydov, Michael Müger, Dmitri Nikshych, and Victor Ostrik. The Witt group of nondegenerate braided fusion categories. *Journal für die reine und angewandte Mathematik (Crelles Journal)*, (677):135–177, 2013.
- [11] Alexei Davydov, Dmitri Nikshych, and Victor Ostrik. On the structure of the Witt group of braided fusion categories. *Selecta Mathematica*, (19):237–269, 2013.
- [12] Pierre Deligne. Catégories tannakiennes. *Progressions in Mathematics*, (87):111–195, 1990.
- [13] Pierre Deligne. Catégories tensorielles. *Moscow Mathematics Journal*, (2):227–248, 2002.

- [14] Vladimir Drinfeld, Shlomo Gelaki, Dmitri Nikshych, and Victor Ostrik. On braided fusion categories I. *Selecta Mathematica*, (16):1–119, 2010.
- [15] Sebas Eliëns. Anyon condensation: Topological symmetry breaking phase transitions and commutative algebra objects in braided tensor categories. Master’s thesis, Universiteit van Amsterdam, Netherlands, 2010.
- [16] Nikshych Dmitri Etingof, Pavel and Victor Ostrik. On fusion categories. *Annals of Mathematics*, 162(2):581–642, 2005.
- [17] Pavel Etingof, Shlomo Gelaki, Dmitri Nikshych, and Victor Ostrik. *Tensor Categories*. Mathematical Surveys and Monographs. American Mathematical Society, 2015.
- [18] Mikhail Finkelberg. An equivalence of fusion categories. *Geometric Functional Analysis*, 6:249–267, 1996.
- [19] Jürgen Fuchs, Ingo Runkel, and Christoph Schweigert. TFT construction of RCFT correlators I: partition functions. *Nuclear Physics B*, 646(3):353 – 497, 2002.
- [20] Jürgen Fuchs and Christoph Schweigert. Consistent systems of correlators in non-semisimple conformal field theory. *Advances in Mathematics*, 307:598 – 639, 2017.
- [21] Jürgen Fuchs, Christoph Schweigert, and Alessandro Valentino. Bicategories for boundary conditions and for surface defects in 3-D TFT. *Communications in Mathematical Physics*, 321(2):543–575, 2013.
- [22] Terry Gannon. The classification of $SU(3)$ modular invariants revisited. *Annales de l’institut Henri Poincaré (A) Physique théorique*, 65(1):15–55, 1996.
- [23] Pinhas Grossman and Noah Snyder. Quantum subgroups of the Haagerup fusion categories. *Communications in Mathematical Physics*, 311(3):617–643, 2012.
- [24] Yi-Zhi Huang, Alexander Kirillov, and James Lepowsky. Braided tensor categories and extensions of vertex operator algebras. *Communications in Mathematical Physics*, 337(3):1143–1159, 2015.
- [25] James E. Humphreys. *Introduction to Lie Algebras and Representation Theory*. Graduate Texts in Mathematics. Springer, 1972.
- [26] André Joyal and Ross Street. Braided tensor categories. *Advances in Mathematics*, 102:20–78, 1993.
- [27] Alexandre Kirillov and Victor Ostrik. On a q -analogue of the McKay correspondence and the ADE classification of \mathfrak{sl}_2 conformal field theories. *Advances in Mathematics*, 171:183–227, 2002.
- [28] Donald E. Knuth. Johann Faulhaber and sums of powers. *Mathematics of Computation*, 61(203):277–294, 1993.

- [29] Liang Kong. Anyon condensation and tensor categories. *Nuclear Physics B*, 886:436–482, 2014.
- [30] Gregory Moore and Nathan Seiberg. Lectures on RCFT. *Superstrings '89*, 1:1–129, 1989.
- [31] Michael Müger. From subfactors to categories and topology II: The quantum double of tensor categories and subfactors. *Journal of Pure and Applied Algebra*, 180(1-2):159–219, 2003.
- [32] Michael Müger. On the structure of modular categories. *Proceedings of the London Mathematical Society*, (87):291–308, 2003.
- [33] Victor Ostrik. Fusion categories of rank 2. *Mathematical Research Letters*, 10:177–183, 2003.
- [34] Victor Ostrik. Module categories over the drinfeld double of a finite group. *International Mathematics Research Notices*, 2003(27):1507–1520, 2003.
- [35] Victor Ostrik. Module categories, weak Hopf algebras and modular invariants. *Transformation Groups*, 8(2):177–206, 2003.
- [36] Victor Ostrik. Pivotal fusion categories of rank 3. *Moscow Mathematical Journal*, 15(2):373–396, 2015.
- [37] Bodo Pareigis. On braiding and dyslexia. *Journal of Algebra*, (171):413–425, 1995.
- [38] Stephen Sawin. Closed subsets of the Weyl alcove and TQFTs. *Pacific Journal of Mathematics*, 228(2):305–324, 2006.
- [39] Stephen Sawin. Quantum groups at roots of unity and modularity. *Journal of Knot Theory and Its Ramifications*, (15):1245–1277, 2006.
- [40] André Schellekens and N. Warner. Conformal subalgebras of Kac-Moody algebras. *Physical Review D*, 34:3092–3096, 1986.
- [41] Andrew Schopieray. Classification of \mathfrak{sl}_3 relations in the Witt group of nondegenerate braided fusion categories. *Communications in Mathematical Physics*, 353(3):1103–1127, 2017.
- [42] Andrew Schopieray. Level bounds for exceptional quantum subgroups in rank two. *submitted for publication*, 2017.