

**FINAL**

# **City of Ontario Transportation System Plan**

Prepared for

**City of Ontario, Oregon and  
Oregon Department of Transportation**



Prepared by



**H. Lee & Associates**

**February 2006**

*This project was funded by a grant from the Transportation and Growth Management Program (TGM), a joint program of the Oregon Department of Transportation and the Department of Land Conservation and Development. TGM grants rely on federal Intermodal Surface Transportation Efficiency Act and Oregon Lottery Funds.*

*The contents of this document do not necessarily reflect the views or policies of the State of Oregon.*

**CITY OF ONTARIO**

**FINAL**

**TRANSPORTATION SYSTEM PLAN**

Prepared for:

City of Ontario and  
Oregon Department of Transportation

Prepared by:

**H. Lee & Associates**  
**P.O. Box 1849**  
**Vancouver, WA 98668**  
**(360) 567-3002**

February 2006

## TABLE OF CONTENTS

SECTION 1 - INTRODUCTION .....	1-1
1.1 Requirements .....	1-1
1.2 Planning Area .....	1-4
1.3 Planning Process.....	1-8
1.4 Other Planning Considerations .....	1-10
SECTION 2 - TRANSPORTATION GOALS AND POLICIES .....	2-1
2.1 Goal 1 - Mobility .....	2-1
2.2 Goal 2 - Efficiency .....	2-2
2.3 Goal 3 - Safety .....	2-2
2.4 Goal 4 - Equity .....	2-3
2.5 Goal 5 - Environmental.....	2-3
2.6 Goal 6 - Alternative Modes of Transportation.....	2-4
2.7 Goal 7 - Maintain Multi-Jurisdictional Coordination.....	2-5
2.8 Goal 8 - Roadway Functional Classification .....	2-6
2.9 Goal 9 - Truck Route.....	2-6
2.10 Goal 10 - Transportation Financing.....	2-6
2.11 Goal 11 - Development of Refinement Plans .....	2-7
SECTION 3 - EXISTING CONDITIONS .....	3-1
3.1 Introduction.....	3-1
3.2 Study Area .....	3-1
3.3 General Street Characteristics.....	3-1
3.4 Road Classification.....	3-2
3.5 Bridges .....	3-8
3.6 Intersection Traffic Control and Lane Channelization .....	3-9
3.7 P.M. Peak Hour Traffic Volumes.....	3-9
3.8 Pedestrian and Bicycle Facilities .....	3-16
3.9 Rail Service.....	3-22
3.10 Truck Freight Service.....	3-23
3.11 Public Transportation .....	3-23
3.12 Air Transportation .....	3-24
3.13 Water Transportation.....	3-24
3.14 Pipeline Facilities .....	3-25
SECTION 4 - EXISTING CONDITIONS AND DEFICIENCIES .....	4-1
4.1 Introduction.....	4-1
4.2 Intersection Levels of Service and v/c Ratio Analysis .....	4-1
4.3 High Crash Locations.....	4-5
4.4 Existing Intersection Capacity Improvement Needs .....	4-6
4.5 Safety Improvement Needs.....	4-6
4.6 Bridges .....	4-7
4.7 Pedestrian and Bicycle Facilities .....	4-7

SECTION 5 - 2025 TRAVEL FORECAST AND FUTURE DEFICIENCIES.....	5-1
5.1 Travel Demand Forecast Methodology.....	5-1
5.2 Travel Demand Forecast Employed for City of Ontario.....	5-2
5.3 2025 Traffic Volume Projections.....	5-2
5.4 Future Intersection and Roadway Capacity Deficiencies.....	5-7
 SECTION 6 - TRANSPORTATION SYSTEM ALTERNATIVES ANALYSIS.....	 6-1
6.1 ODOT STIP Projects.....	6-1
6.2 Other Improvements.....	6-4
6.3 Intersection Improvements.....	6-9
 SECTION 7 - TRANSPORTATION MODAL PLANS.....	 7-1
7.1 Road Plan.....	7-1
7.2 Pedestrian and Bicycle System Plan.....	7-20
7.3 Public Transportation Plan.....	7-29
7.4 Air, Rail, Water, Pipeline Plan.....	7-31
 SECTION 8 - FINANCE PLAN.....	 8-1
8.1 Transportation Improvement Revenue Needs.....	8-1
8.2 Historical Street Improvement Funding Sources.....	8-1
8.3 Transportation Revenue Outlook.....	8-4
8.4 Revenue Sources and Financing Options.....	8-6

APPENDIX

## LIST OF TABLES

Table 3-1. ODOT Bridge Ratings .....	3-9
Table 4-1. Maximum Volume-to-Capacity Ratios for Peak Hour Operating Conditions Through A Planning Horizon for State Highway Sections Located Outside the Portland Metropolitan Area Urban Growth Boundary .....	4-2
Table 4-2. Existing Levels of Service .....	4-4
Table 4-3. Intersection Crash Summary .....	4-5
Table 5-1. Year 2025 Levels of Service – No Build Alternative.....	5-6
Table 6-1. Transportation Project List Still Relevant from Previous TSP .....	6-6
Table 7-1. Street Standards .....	7-4
Table 7-2. Local Street Network Improvement Projects.....	7-17
Table 7-3. Bicycle and Pedestrian Capital Improvement List and Cost.....	7-25
Table 8-1. Sources of Road Revenues by Jurisdiction Level.....	8-2
Table 8-2. City of Ontario Street Fund Revenues .....	8-3
Table 8-3. City of Ontario Street Fund Expenditures.....	8-3
Table 8-4. Estimated Resources Available to City of Ontario from State Highway Fund.....	8-6

## LIST OF FIGURES

Figure 1-1a. Study Area Map .....	1-5
Figure 1-1b. Study Area Map .....	1-6
Figure 3-1a. Existing Roadway Classification.....	3-3
Figure 3-1b. Existing Roadway Classification .....	3-4
Figure 3-2a. Bridge Locations .....	3-10
Figure 3-2b. Bridge Locations .....	3-11
Figure 3-3a. Location of Study Area Intersections .....	3-12
Figure 3-3b. Location of Study Area Intersections.....	3-13
Figure 3-4. Existing Lane Configuration and Traffic Control .....	3-14
Figure 3-5. Existing Weekday P.M. Peak Hour Traffic Volumes .....	3-15
Figure 3-6a Existing Sidewalk Inventory.....	3-18
Figure 3-6b Existing Sidewalk Inventory .....	3-19
Figure 3-7a. Bike Facility Inventory .....	3-20
Figure 3-7b. Bike Facility Inventory .....	3-21
Figure 5-1a. Location of Study Area Intersections .....	5-3
Figure 5-1b. Location of Study Area Intersections.....	5-4
Figure 5-2. 2025 Weekday P.M. Peak Hour Traffic Volumes .....	5-5
Figure 6-1a. Location Map of Transportation Projects Still Relevant from Previous TSP .....	6-7
Figure 6-1b. Location Map of Transportation Projects Still Relevant from Previous TSP .....	6-8
Figure 7-1a. Roadway Classification .....	7-2
Figure 7-1b. Roadway Classification .....	7-3
Figure 7-2. Typical Roadway Cross Section Standards – Principal Arterial .....	7-5
Figure 7-3. Typical Roadway Cross Section Standards – Minor Arterial.....	7-6
Figure 7-4. Typical Roadway Cross Section Standards – Collector.....	7-7
Figure 7-5a. Typical Roadway Cross Section Standards – Neighborhood Collector Greater Than 2%.....	7-8
Figure 7-5b. Typical Roadway Cross Section Standards – Neighborhood Collector Equal to or Less Than 2% .....	7-9
Figure 7-6a. Typical Roadway Cross Section Standards – Local Street Greater Than 2% .....	7-10
Figure 7-6b. Typical Roadway Cross Section Standards – Local Street Equal to or Less Than 2%.....	7-11
Figure 7-7a. Typical Roadway Cross Section Standards – Skinny Local Street Greater Than 2% .....	7-12
Figure 7-7b. Typical Roadway Cross Section Standards – Skinny Local Street Equal to or Less Than 2% .....	7-13
Figure 7-8. Typical Roadway Cross Section Standards – Cul de Sac Turn Around .....	7-14
Figure 7-9a. Local Street Network Plan.....	7-18
Figure 7-9b. Local Street Network Plan.....	7-19
Figure 7-10. Shared Roadway Bike Facility .....	7-21
Figure 7-11. Shoulder Bikeway Facility .....	7-22
Figure 7-12. Bike Lane Facility.....	7-23
Figure 7-13. Multi-Use Path Facility.....	7-24
Figure 7-14a. Bicycle and Pedestrian Improvement Project Locations.....	7-27
Figure 7-14b. Bicycle and Pedestrian Improvement Project Locations .....	7-28
Figure 8-1. State Highway Fund (in Millions of Dollars) .....	8-5

**SECTION 1.0**  
**INTRODUCTION**



## **Section 1.0 Introduction**

The City of Ontario Transportation System Plan (TSP) addresses the city's anticipated transportation needs through the year 2025. It has been prepared to meet state and federal regulations that require urban areas to conduct long-range planning. Specifically, the TSP was developed in compliance with requirements of the Transportation Equity Act for the 21<sup>st</sup> Century (TEA-21), Statewide Planning Goal 12, the Transportation Planning Rule (TPR – Oregon Administrative Rule (OAR) Chapter 660, Division 12), and Oregon Highway Plan (1999). The long-range planning is intended to serve as a guide for the City of Ontario in managing their existing transportation facilities and developing future transportation facilities.

### **1.1. REQUIREMENTS**

The TEA-21, Statewide Planning Goal 12, the Transportation Planning Rule, and Oregon Highway Plan (OHP) requirements guiding the development of the City of Ontario TSP are discussed below.

#### **1.1.1. TEA-21**

TEA-21 is federal legislation that was passed in 1998. It specifies requirements for statewide and metropolitan area planning. Although TEA-21 does not specify requirements for areas less than a population of 50,000, it is still relevant to the City of Ontario's TSP planning since it defines how federal aid is dispersed for highway and transit projects. The planning requirements under TEA-21 parallel the requirements under the TPR.

#### **1.1.2. Goal 12**

Oregon adopted 19 Statewide Planning Goals in the mid-1970s. These goals were to be implemented in each local jurisdiction's comprehensive plan. Goal 12 of the statewide planning goals related to transportation. The intent of Goal 12 is to "provide and encourage a safe, convenient, and economic transportation system." It provides the following guidelines in creating a transportation element of a local jurisdiction's comprehensive plan:

"A transportation plan shall (1) consider all modes of transportation including mass transit, air, water, pipeline, rail, highway, bicycle and pedestrians; (2) be based upon an inventory of local, regional and state transportation needs; (3) consider the differences in social consequences that would result from utilizing differing combinations of transportation modes; (4) avoid principal reliance upon any one mode of transportation; (5) minimize adverse social, economic and environmental impacts and costs; (6) conserve energy; (7) meet

the needs of the transportation disadvantaged by improving transportation services; (8) facilitate the flow of goods and services so as to strengthen the local and regional economy; and (9) conform to local and regional comprehensive land use plans.”

### **1.1.3. Transportation Planning Rule (TPR)**

The Transportation Planning Rule (TPR) was developed by the Department of Land Conservation and Development (DLCD) and Oregon Department of Transportation (ODOT). It was adopted originally in April 1991 to implement Goal 12 of the Statewide Planning Goals.

The TPR requires that cities, counties, Metropolitan Planning Organizations (MPOs), and state agencies prepare and adopt transportation system plans. A transportation system plan is defined in the TPR as: “a plan for one or more transportation facilities that are planned, developed, operated and maintained in a coordinated manner to supply continuity of movement between modes, and within and between geographic and jurisdictional areas.” The TPR encourages multi-modal transportation systems to reduce the dependence on auto traffic.

The transportation system plan elements produced included the following:

- Street system plan for a network of arterials, collectors, and local streets
- Bicycle and pedestrian plan and integrate with the parks plan/dream trails map and the Parks Master Plan
- Public transportation plan
- Air, rail, water, and gas pipeline plan
- Policies and land use regulations for implementing the TSP
- Transportation system and demand management plan
- Transportation financing plan

### **1.1.4. Oregon Highway Plan (1999)**

The 1999 Oregon Highway Plan (OHP) was adopted by the Oregon Transportation Commission on March 18, 1999. It applies the general directives specified in the 1992 Oregon Transportation Plan. The general directives of the 1992 Oregon Transportation Plan called for a transportation system marked by modal balance, efficiency, accessibility, environmental responsibility, connectivity among places, connectivity among modes and carriers, safety, and financial stability. The 1999 OHP applies the 1992 Oregon Transportation Plan general directives by emphasis on:

- Efficient management of the system to increase safety, preserve the system and extend its capacity;
- Increased partnerships, particularly with regional and local governments;
- Links between land use and transportation;
- Access management;

- Links with other transportation modes; and
- Environmental and scenic resources

There are several policies within the 1999 OHP that local jurisdictions are required to be consistent with in their transportation system plans. Specifically, the OHP states:

“Local and regional jurisdictions must be consistent with Policies 1A, State Highway Classification System; 1B, Land Use and Transportation; 1C, State Highway Freight System; 1D, Scenic Byways; 1F, Highway Mobility Standards; 1G, Major Investments; 2G, Rail and Highway Compatibility; 3A-E, Access Management; 4A, Efficiency of Freight Movement; 4D, Transportation and Demand Management; and the Investment Policy in their local and regional plans when planning for state highway facilities within their jurisdiction.”

On January 14, 2004 the Oregon Transportation Commission approved amendments to Policy 1B of the 1999 Oregon Highway Plan. Policy 1B, the land use and transportation policy of the Highway Plan, furthers the goal of efficient management by working with local governments to coordinate land use and transportation planning. The amended policy clarifies the process and requirements for highway segment designations.

Since the original adoption of the Oregon Highway Plan, other amendments have also been made. These amendments include:

- 99-01: Highway Reclassification (9 November 1999)
- 00-02: Expressway Classification (11 May 2000)
- 00-03: Expressway Classifications and Technical Corrections (7 June 2000)
- 00-04: Alternate Mobility Standards for Rogue Valley MPO and Metro (13 December 2000)
- 01-05: Expressway Classifications (11 April 2001)
- 01-06: Conditional Designation of STAs and Designation of UBAs (9 August 2001)
- 02-07: Jurisdictional Transfers (November 2002)
- 03-08: Bypass Policy (16 April 2003)
- 03-09: Amendment of Appendix E: National Highway System Intermodal Connectors (18 June 2003)
- 04-11: Highway Segment Designations (14 January 2004)
- 04-11: Highway Segment Designation Maps (14 January 2004)
- 04-12: Technical Corrections to the Oregon Highway Plan (2 July 2004)
- 04-13: Technical Corrections to the Oregon Highway Plan (20 December 2004)

### **1.1.5. Other State Plans**

In addition to those specific requirements described above, coordination with other specific state plans is also required. These plans include:

- Oregon Bicycle and Pedestrian Plan, ODOT, June 14, 1995
- Oregon Rail Plan, ODOT, November 8, 2001

- Oregon's Mobility Needs, Final Report, June 1999
- 1997 Oregon Public Transportation Plan, ODOT
- Freight Moves the Oregon Economy, ODOT, July 1999

## **1.2. PLANNING AREA**

The City of Ontario Transportation System Plan covers both the incorporated area of the city as well as the urban growth boundary (UGB). The planning area for the City of Ontario TSP is shown in Figures 1-1a and 1b. Roadways included in the Transportation System Plan fall under several jurisdictions: the City of Ontario, the Oregon Department of Transportation, and Malheur County.

Ontario is the largest urban area in Malheur County and accounts for almost 40 percent of the county's population. In 1998, Ontario's population was 10,680 having grown 13.7 percent from 9,394 in 1990.

Ontario and the surrounding area constitute a small but rapidly growing community. Ontario's location along the I-84 corridor in the far eastern portion of Oregon, and its desirable climate, outstanding scenery, and proximity to recreation assure that growth will continue at a strong pace. The area is economically vital, supported by agriculture and food processing, retailing, medical services, and an increasingly important tourist trade. Ontario serves as a regional service center drawing from a large geographic area comprising portions of Oregon and Idaho. Employment and services in Ontario exceed those typical of a town of its size. In addition, Ontario is attractive to retired people because of its relatively inexpensive housing, availability of medical services, and numerous amenities.

Initially, Ontario developed parallel to the railroad tracks, resulting in a slightly skewed alignment from a true north-south and east-west orientation. The newer portions of the town have developed with a north-south and east-west orientation.

The railroad tracks are the most significant disruption to the continuity of the grid street pattern. Only three railroad crossings are present; one is an underpass (E. Idaho Avenue), one is an overpass (SE 18th Avenue) and two are at-grade crossings (SE 5<sup>th</sup> Avenue and SE 6<sup>th</sup> Avenue). Other features which disrupt the uniformity of the grid street pattern include several schools, parks, the fairgrounds, and the community college. The grid system west of Park Boulevard and 10<sup>th</sup> Street is somewhat less uniform than the portions of the city to the east. The western portion of the city tends to be newer and features longer blocks, more curvilinear streets and cul-de-sacs.

The majority of the city's land area, residents, businesses (including the downtown area), fire station, and schools lie to the west of the railroad tracks. The city's principal interchange for I-84 and its more recently developed, highway-oriented businesses are on the east side of the railroad tracks.

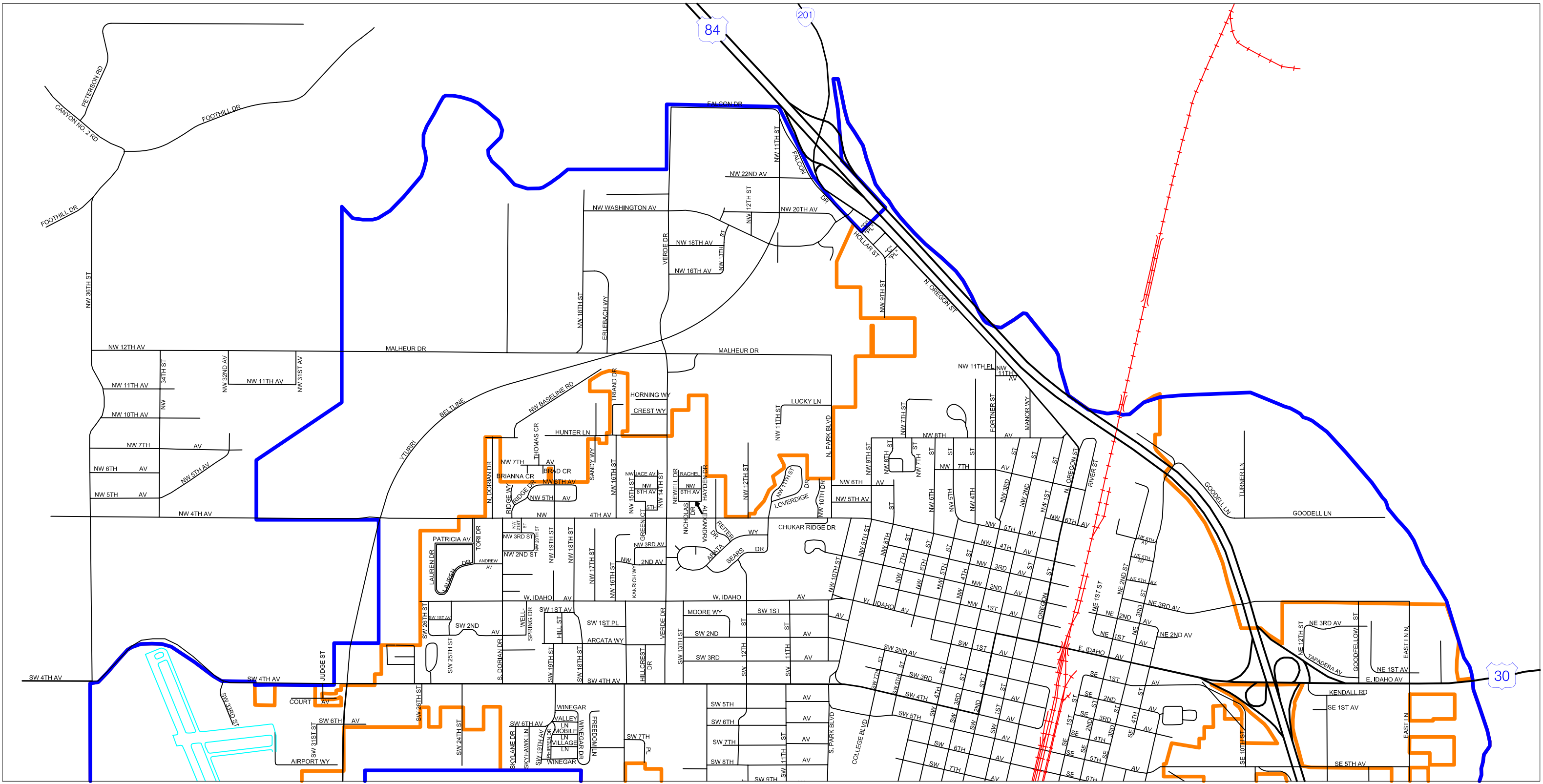

# City of Ontario Transportation System Plan

## LEGEND

- City Limits
- Urban Growth Boundary



**Figure 1-1a**  
Study Area Map

NOT TO SCALE

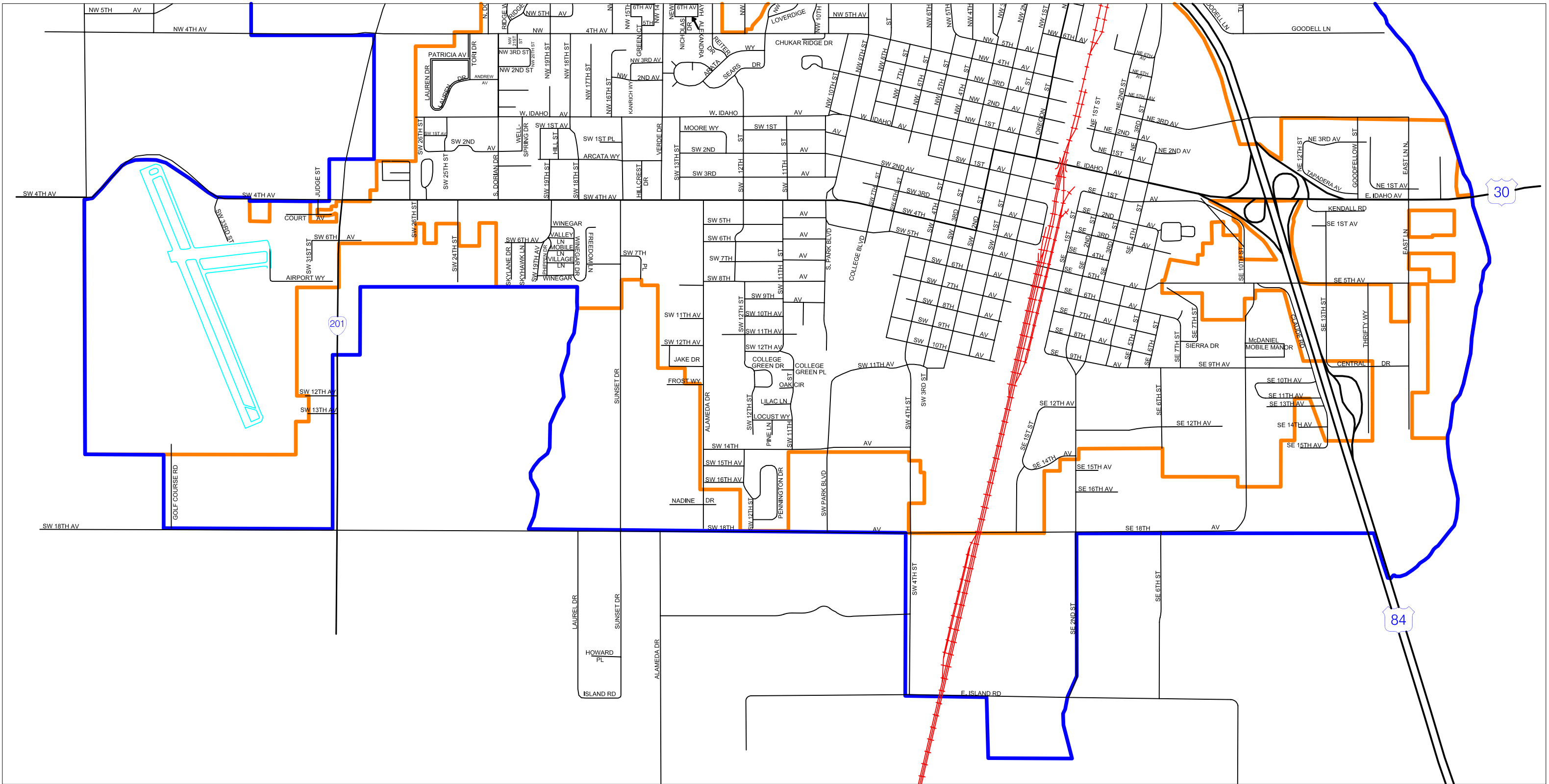

# City of Ontario Transportation System Plan

**Figure 1-1b**  
Study Area Map

**LEGEND**  
 City Limits  
 Urban Growth Boundary

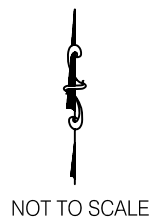

NOT TO SCALE

I-84 is the principal highway in Ontario. By virtue of its limited-access design, it provides little in the way of internal transportation. Other principal highways in the Ontario region include the Olds Ferry-Ontario Highway (OR 201) and the Ontario Spur (OR 201 and Business US 30, and US 30) which connects to Idaho. The southerly section of OR 201 between Ontario and Cairo Junction, which serves as a connection to US 26 westerly to Redmond and Madras, is part of the Access Oregon Highway (AOH) system.

The city is served by two I-84 interchanges. The northern interchange provides access to the Yturri Beltline which allows motorists to circumvent Ontario when headed to Vale and Malheur County.

Much of the city's commercial property has developed along the state highway corridors. These formerly included Oregon Street, Idaho Street, and SW 4<sup>th</sup> Avenue; however, much of these streets have been transferred to the City's jurisdiction. Highway accesses to businesses in the past were allowed to proliferate; this pattern, typical of cities located along highway corridors, encourages automobile traffic to the exclusion of other forms of transportation. Without access management, as the area grows, the conflicts of extensive access and highway traffic increase.

Idaho Avenue on either side of I-84 has major highway-oriented businesses. These include truck stops, motels, fast food restaurants, and major retail establishments. Idaho Avenue is a significant concern because of the combination of high volumes of through traffic, turning movements and the volumes of trucks.

Much of the community's industrial land uses are adjacent to the railroad tracks. The industrial uses include a variety of agricultural and food processing facilities. Truck traffic destined for these sites is a particular concern and high volumes of truck traffic are especially prevalent during harvest season.

Local streets in Ontario are generally very wide. The streets are largely paved with an oil mat surface over native materials. On the average, streets are in fairly good condition; however, lack of an adequate base coupled with insufficient funding for surfacing and maintenance is contributing to a decline in condition. Sidewalks are provided in scattered locations and, in some cases, pedestrians must share the streets with cars and trucks. The low traffic volumes and width of local streets has minimized conflicts between pedestrians and motorists; however, conflicts will grow as volumes increase. The lack of continuous walkways discourages some individuals from walking as a form of transportation.

Public services for the elderly and handicapped include vans operated by senior centers.

Intercity public transportation includes Amtrak and Greyhound bus. Amtrak currently offers only bus service. Greyhound offers daily service along I-84 in both directions with two to four buses depending the time of year.

The challenge for the future of the Ontario area is to provide a transportation system that will accommodate growth without the traffic problems that often accompany rapid growth. Appropriate planning while Ontario is still relatively small will provide the opportunity to avoid the transportation problems that plague many cities.

### **1.3. PLANNING PROCESS**

The transportation system plan (TSP) was developed through a series of technical exercises and input from the public, citizen advisory committee, and technical advisory committee. The key elements of the process to develop the TSP are listed below.

- Define goals and objectives
- Review of existing plans and policies
- Solicit public involvement and input
- Conduct an existing inventory and condition analysis
- Project future traffic volumes
- Define deficiencies and needs
- Develop transportation improvement projects for all modes
- Define transportation facility standards and requirements
- Develop recommended policies and ordinances
- Develop modal plans for each mode of transportation
- Develop a finance plan

#### **1.3.1. Define Transportation Policies and Implementing Strategies**

Transportation policies and implementing strategies were developed based on input from City of Ontario staff and requirements of the TPR. The transportation policies and implementing strategies were used later to guide the development of transportation system plan, to make decisions regarding various transportation improvement projects, developing new standards and requirements, and to provide a direction for making transportation-related decisions for the county.

#### **1.3.2. Review of Existing Plans and Policies**

To begin the transportation planning process, all applicable City of Ontario transportation and land use plans and policies were reviewed. The purpose of this review was to develop an understanding of how the City of Ontario was managing its transportation infrastructure. Also, the plan and policy review defined where the county is compliant and deficient in meeting the Transportation Planning Rule (TPR) requirements. Where deficiencies exist in meeting the TPR requirements, recommendations will be made that will comply with the TPR requirements.



### **1.3.3. Solicit Public Involvement and Input**

Community involvement is an integral component in the development of a TSP for the City of Ontario. Several different techniques were utilized to involve the general public.

An advisory committee (AC) provided guidance on technical issues and direction regarding policy issues to the consultant team; Staff members, planning commissioners, local stakeholders, and ODOT served on this committee, and the group met several times during the course of the project.

The second part of the community involvement effort consisted of a public open house and a series of joint Planning Commission/City Council workshops, Planning Commission public hearings, and a City Council public hearings. The public was notified of the public meetings through public announcements in the local newspapers and on the local radio stations.

### **1.3.4 Conduct an Existing Inventory and Condition Analysis**

The purpose of the existing inventory and conditions analysis was to catalog all the existing transportation facilities and services to determine its operating condition. This information provides the baseline from which the plan can be developed.

### **1.3.5. Define Deficiencies and Needs**

Based on the existing inventory and conditions analysis, a transportation deficiencies list was developed. The inventory and existing conditions analysis forms the technical basis for the deficiencies list.

The future transportation deficiencies were identified from the Year 2025 future traffic projections. The traffic forecast was used to calculate level of service and volume-to -capacity (v/c) ratios. Based on these results, the locations of future traffic deficiencies were identified. The combination of existing and future deficiencies defines the need to develop improvement alternatives.

### **1.3.6. Develop Transportation Improvements**

Based on the deficiencies and needs list, a transportation improvement plan was developed with alternatives. These improvements and alternatives were developed in conjunction with attempting to meet the transportation policies and strategies. Based on an evaluation process, a preferred alternative was selected and individual improvements were prioritized into high, medium, and low priorities.

### **1.3.7. Define Transportation Facility Standards and Requirements**

Transportation facility standards were developed to guide the City of Ontario in managing its roadways as well as a guideline in developing new infrastructure. These standards include access management requirements, road standards for a variety of street classifications, sidewalk width standard, bicycle facility standards, bicycle parking requirements, access-way requirements, internal pedestrian connection requirements, and block and street spacing requirements. The various standards will be documented in the relevant modal plans.

### **1.3.8. Develop Recommended Policies and Ordinances**

The development of the transportation system within the City of Ontario requires that policies in the Comprehensive Plan support its implementation. Also requirements adopted by ordinance(s) are necessary for transportation facilities to develop with new development. This section evaluates the existing policies, standards, and requirements and makes recommendations to enhance policies, standards, and requirements that would support the further development of the transportation system within the City of Ontario.

### **1.3.9. Develop a Modal Plan for Each Mode of Transportation**

Modal plans for each mode of transportation within the City of Ontario were developed. The modal plans were developed from all of the sections described above. The intent of each modal plan was to develop improvement projects that meet the 2025 year need, establish and update standards and requirements complying with the Transportation Planning Rule, and creating and updating comprehensive plan policies that guide the development of the transportation system within the City of Ontario.

### **1.3.10. Develop a Finance Plan**

A finance plan was developed to identify a strategy to fund all of the transportation improvement projects developed. The finance plan starts with existing transportation funding levels. The existing revenues were then compared with the costs of the proposed improvements. Based on a revenue shortfall for funding future projects, a series of funding options was discussed and a strategy proposed.

## **1.4. OTHER PLANNING CONSIDERATIONS**

Environmental conditions have a potentially significant impact to the development of new transportation infrastructure. TPR requirement OAR 660-012-0035 (3) (c) states that “the transportation system shall minimize adverse economic, social, environmental and energy consequences.” In the development of transportation improvements, a cursory look at environmental impacts was conducted from existing sources and known environmental issues by

the City of Ontario staff. The goal in the cursory environmental analysis was to minimize environmental impacts by any proposed transportation improvement.

Another consideration in the development of transportation improvement projects was to be consistent and support the transportation policies and implementing strategies to guide the development of the alternative proposals.

**SECTION 2.0**  
**TRANSPORTATION GOALS AND POLICIES**

## **Section 2.0**

### **Transportation Goals and Policies**

This section establishes broad policy objectives that provide the context to make transportation investment decisions and to develop the existing and future transportation system within the City of Ontario urban growth boundary.

#### **2.1. GOAL 1 – MOBILITY**

**It is the goal of the City of Ontario to provide a multi-modal transportation system that maximizes the mobility of Ontario residents and businesses.**

The policies to be used to implement Goal 1 – Mobility are as follows:

- 1.1. Establish a transportation system that can accommodate a wide variety of travel modes and minimizes the reliance on any one single mode of travel.
- 1.2. Properly plan transportation infrastructure to meet the level of service set for each type of facility.
- 1.3. Maintain a level of service standard of LOS D or better for signalized intersections and a level of service of LOS E at unsignalized intersections if the intersection does not meet the most current Manual of Uniform Traffic Control Devices (MUTCD) signal warrants. If the intersection meets signal warrants, then the level of service standard for the unsignalized intersection shall be LOS D. At least two MUTCD signal warrants shall be met prior to consideration of signalization. A traffic study shall be conducted to analyze the potential installation of a signal that includes average daily traffic counts by hour on all intersection approaches, a signal warrant analysis based on the most recent MUTCD, and any other factors identified by a traffic engineer deemed as a factor for signalization such as poor sight distance, vehicle travel speed, and intersection geometric conditions.

For Oregon Department of Transportation (ODOT) facilities, the City of Ontario shall defer to ODOT mobility standards described in the most recent version of the *Oregon Highway Plan*.

- 1.4. Develop a local street plan to preserve future rights-of-way for future streets and to maintain adequate local circulation in a manner consistent with Ontario's existing street grid system.
- 1.5. Require developments to construct their accesses consistent with the local street plan.

- 1.6. Develop an access management policy for the local arterial system and direct commercial development access to local streets wherever possible.
- 1.7. Encourage development to occur near existing community centers where services are presently available to minimize the need for expanding services and to more efficiently utilize existing resources.
- 1.8. Identify local traffic problems and recommend solutions.
- 1.9. Review and revise, if necessary, street cross section standards for local, collector, and arterial streets to enhance safety and mobility.
- 1.10. Develop and adhere to a capital improvement program implementing the improvement recommendations of the TSP as funding is identified.

## **2.2. GOAL 2 – EFFICIENCY**

**It is the goal of the City of Ontario to create and maintain a multi-modal transportation system with the greatest efficiency of movement possible for Ontario residents and businesses in terms of travel time, travel distance, and efficient management of the transportation system.**

The policies to be used to implement Goal 2– Efficiency are as follows:

- 2.1. Develop the City of Ontario’s transportation system with alternative parallel corridors to reduce reliance on any one corridor and improve local access through a local street plan that preserves future rights-of-way for future streets that develops Ontario’s local street system consistent with a grid pattern.
- 2.2. Plan and improve routes to facilitate the movement of goods and services.
- 2.3. Manage the City of Ontario’s resources to improve the transportation system through an up-to-date Capital improvement program reflecting the transportation needs of the city.

## **2.3. GOAL 3 – SAFETY**

**It is the goal of the City of Ontario to maintain and improve transportation system safety.**

The policies to be used to implement Goal 3 – Safety are as follows:

- 3.1. Examine the need for speed reduction in specific areas such as adjacent to local schools.

- 3.2. Ensure that the multi-modal transportation system within Ontario is structurally and operationally safe.
- 3.3. Periodically review crash records in an effort to systematically identify and remedy unsafe intersection and roadway locations.
- 3.4. Develop a traffic calming program to implement in areas with vehicle speeding issues.
- 3.5. Ensure adequate access for emergency services vehicles throughout the city's transportation system.

## **2.4. GOAL 4 – EQUITY**

**It is the goal of the City of Ontario to ensure the cost of transportation infrastructure and services are borne by those who benefit from them.**

The policies to be used to implement Goal 4 - Equity are as follows:

- 4.1. System Development Charges (SDCs) shall be considered to be implemented and it should accurately reflect a nexus between the traffic impact of development and the fees assessed to the development.
- 4.2. The City of Ontario shall seek equitable funding mechanisms to maintain transportation infrastructure and services to an acceptable level.
- 4.3. Developments shall be responsible for mitigating their direct traffic impacts. These impacts shall be determined through a traffic study requirement to the developer.

## **2.5. GOAL 5 – ENVIRONMENTAL**

**It is the goal of the City of Ontario to limit and mitigate adverse environmental impacts associated with traffic and transportation system development.**

The policies to be used to implement Goal 5 – Environmental are as follows:

- 5.1. Transportation project related environmental impacts shall be identified at the earliest opportunity to ensure compliance with all federal and state environmental standards.
- 5.2. Transportation project environmental impacts shall be mitigated to state and federal standards as appropriate.

## 2.6. GOAL 6 – ALTERNATIVE MODES OF TRANSPORTATION

**Increase the use of alternative modes of transportation (walking, bicycling, rideshare/carpooling, and transit) through improved access, safety, and service. Increasing the use of alternative transportation modes includes maximizing the level of access to all social, work, and welfare resources for the transportation disadvantaged. The City of Ontario seeks for its transportation disadvantaged citizens the creation of a customer-oriented regionally coordinated public transit system that is efficient, effective, and founded on present and future needs.**

The policies to be used to implement Goal 6 – Alternative Modes of Transportation are as follows:

- 6.1. Develop a citywide pedestrian and bicycle plan providing for sidewalks, bikeways, and safe crossings.
- 6.2. Promote alternative modes and rideshare/carpool programs through community awareness and education.
- 6.3. Coordinate with regional transit service efforts.
- 6.4. Seek Transportation and Growth Management (TGM) and other funding for projects evaluating and improving the environment for alternative modes of transportation.
- 6.5. Seek improvements of mass transit services to the City of Ontario.
- 6.6. Transportation Disadvantaged
  - a. Continue to support programs for the transportation disadvantaged where such programs are needed and are economically feasible.
  - b. Increase all citizens' transportation choices.
  - c. Identify and retain community identity and autonomy.
  - d. Create a customer-oriented focus in the provision of transportation services.
  - e. Hold any regional system accountable for levels and quality of service.
  - f. Enhance public transportation sustainability.
  - g. Promote regional planning of transportation services.
  - h. Use innovative technology to maximize efficiency of operation, planning, and administration of public transportation.



- i. Promote both inter-community and intra-community transportation services for the transportation disadvantaged.

## **2.7. GOAL 7 – MAINTAIN MULTI-JURISDICTION COORDINATION**

### **Maintain coordination between the City of Ontario, Malheur County, and the Oregon Department of Transportation (ODOT).**

The policies to be used to implement Goal 7 – Maintain Multi-Jurisdictional Coordination are as follows:

- 7.1 Cooperate with ODOT in the implementation of the Statewide Transportation Improvement Program (STIP).
- 7.2 Encourage improvement of state highways.
- 7.3 Work with ODOT and Malheur County in establishing cooperative road improvement programs and schedules.
- 7.4 Work to establish the right-of-way needed for new roads identified in the TSP.
- 7.5 Take advantage of federal and state highway funding programs.
- 7.6 The City of Ontario shall maintain an urban growth boundary (UGB) management agreement with the Malheur County. This agreement shall be the basis to manage facilities outside the city limits of the City of Ontario but within the UGB as well as to eventually transfer facilities from Malheur County to the City of Ontario when annexations occur.
- 7.7 Jurisdictional transfers between the City of Ontario and the Oregon Department of Transportation (ODOT) shall be conducted through a management agreement between the two agencies. The conditions of a jurisdictional transfer of facilities shall be negotiated on a case by case basis.
- 7.8 The City of Ontario shall coordinate with Malheur County to update its transportation system plan (TSP). Consistency between the City of Ontario and Malheur County's TSPs shall be sought.
- 7.9 For Oregon Department of Transportation facilities, the City of Ontario shall defer to ODOT access management standards described in Division 51 and/or the most recent ODOT adopted access management standards and regulations.

## **2.8. GOAL 8 – ROADWAY FUNCTIONAL CLASSIFICATION**

**It is the goal of the City of Ontario to properly plan and maintain its transportation system based on a roadway functional classification system. The street and access standards are based on this roadway functional classification system.**

The policies to be used to implement Goal 8 – Roadway Functional Classification are as follows:

- 8.1. The transportation system plan (TSP) shall classify roadways throughout the city's transportation system. Arterial, collector and local street classifications shall be identified in the TSP.
- 8.2. The street and access standards shall employ the roadway functional classification system.
- 8.3. Encourage use of alternative methods, such as alleys, shared driveways, etc., i.e. smart development techniques, to provide property access.
- 8.4. The roadway functional classification system represents a continuum in which through traffic increases and access provisions decrease in the higher classification categories. The street and access standards shall reflect this principal.

## **2.9. GOAL 9 – TRUCK ROUTE**

**It is the goal of the City of Ontario to identify and designate a through truck route system utilizing arterial and major collector roads and to minimize impacts to residential areas.**

The policies to be used to implement Goal 9 – Truck Route are as follows:

- 9.1. The City of Ontario shall designate a through truck route along its arterials and major collectors. The truck route shall be defined in the TSP.
- 9.2. Minimize use of other city roadways by truck traffic except by truck traffic for local deliveries and pickups.

## **2.10. GOAL 10 – TRANSPORTATION FINANCING**

**It is the goal of the City of Ontario to seek adequate financial revenues to fund its Capital Improvement Program and maintenance needs.**

The policies to be used to implement Goal 10 – Transportation Financing are as follows:

- 10.1. The City of Ontario shall aggressively seek state and federal funding for relevant transportation projects.
- 10.2. The City of Ontario shall proactively seek new local and regional funding sources for its Capital Improvement Program.

## **2.11. GOAL 11 – DEVELOPMENT OF REFINEMENT PLANS**

**It is the goal of the City of Ontario to develop refinement plans to the Transportation System Plan that more specifically address corridors, problems/issues, and sub-areas. These refinement plans shall supersede the TSP if they are formally adopted by the Ontario City Council.**

The policies to be used to implement Goal 11 – Development of Refinement Plans are as follows:

- 11.1 The City of Ontario has formally adopted the following refinement plans; East Ontario Traffic Study; East Ontario Commercial Area Traffic Study; Oregon 201 Corridor Refinement Plan; and, the North Ontario Interchange Management Area Plan. These Plans shall supersede the TSP in their specific defined areas as applicable.
- 11.2 The City of Ontario shall proactively seek funding to develop further refinement plans as necessary to address specific transportation issues.
- 11.3 Refinement plans to the TSP shall be formally adopted by the Ontario City Council prior to officially superseding the TSP.

**SECTION 3.0**  
**EXISTING INVENTORY**

## **Section 3.0 Existing Inventory**

### **3.1. INTRODUCTION**

This section of the City of Ontario Transportation System Plan describes the existing transportation inventory within the city's urban growth boundary (UGB). The section reviews past plans and studies and inventories the existing transportation conditions. This information will be used as a foundation for identifying short-term transportation improvement needs and developing and evaluating longer-term transportation system alternatives.

### **3.2. STUDY AREA**

The planning area for the City of Ontario Transportation System Plan is the UGB. This has been previously defined in Section 1.

The northern study area boundary generally follows the Malheur River and Falcon Drive. The southern boundary follows 18<sup>th</sup> Avenue, 4<sup>th</sup> Street, south of Island Road (25<sup>th</sup> Avenue), and 18<sup>th</sup> Avenue. I-84 and the Snake River make up the eastern boundary of the study area. The western boundary is the Ontario Municipal Airport.

### **3.3. GENERAL STREET CHARACTERISTICS<sup>1</sup>**

There are approximately 60 miles of public roads in the City of Ontario street system. About 56 miles are paved streets and approximately four miles are unpaved. The totals for the Ontario area include a north-south section of I-84 which runs for about two and a half miles through the city. Other key elements of the city street system are made-up of approximately six miles of principal arterial streets, 11 miles of minor arterial streets, nine miles of collector streets, and the rest comprised of local streets.

The street widths vary from 18 feet to 72 feet. The majority of the streets in the downtown core area of the city vary from 40 feet wide to 54 feet wide. These unusually wide streets within the city promote or provide for high traffic volumes, and encourage increased speeds. A 54-foot-wide street could easily accommodate four lanes of traffic without curbside parking. Such streets may be appropriate for major traffic routes, but are less desirable in a local neighborhood. Extra width may contribute to excessive heat during the summer and increased storm water runoff during rain storms. The greater width of the City of Ontario streets does allow the storage of snow in the center of the street rather than along the sides where it can block driveways and storm sewers.

Most of the principal arterials in downtown have five-foot sidewalks. Along principal arterials, about 58 percent of the roadways have sidewalks and only seven percent of these sidewalks are

---

<sup>1</sup> Ontario Transportation System Plan, DEA, November 12, 1999.  
*City of Ontario Transportation System Plan*

buffered by planting strips. Along all minor arterials, only 17 percent of the roadways have sidewalks. About 27 percent of the collectors have sidewalks. About 45 percent of the local streets have sidewalks. In summary, only 39 percent of the entire street system, excluding I-84 in the City of Ontario, have sidewalks (15.09 miles out of 38.40 miles).

While there is a good grid of connecting streets in the core of the City of Ontario, no city streets run the entire length of the city from north to south. This feature encourages traffic to use the state highways (I-84, US 30, and OR 201) since these are among the only roads that connect the City of Ontario from one end to the other.

### **3.4. ROAD CLASSIFICATION**

#### **3.4.1. Road Classification System**

The roadway functional classifications were obtained from ODOT's Oregon Transportation Map for the City of Ontario. This map is typically coordinated between the State of Oregon and the City of Ontario to coordinate classifications of roadways between jurisdictions. The map was last updated in 2005 and reflects current coordinated roadway classification efforts between ODOT and the City of Ontario. This roadway functional classification is shown in Figures 3-1a and 3-1b.

The existing roadway functional classification system is made up of the following five classifications:

- principal arterial,
- minor arterial,
- major collector,
- minor collector, and
- local road.

Of these five roadway functional classifications, all of them exist in the City of Ontario study area.

Typically, a principal/minor arterial is designated as a road which carries the highest volume of traffic within the city. It is primarily intended to provide access across and through the city rather than provide access to abutting properties. A collector road typically provides access between arterials, to abutting properties, and from neighborhoods onto arterials. A local road is intended to solely serve abutting properties.

#### **3.4.2. State Facilities**

State highways traversing through Ontario creates the backbone of the city's road system. Although the City of Ontario has no direct control over the use of the state highways, the traffic pattern in Ontario is heavily influenced by the state highways. The City of Ontario is served by an interstate highway, I-84, and by two state highways, OR 201 and US 30 (US 30 and business route US 30).

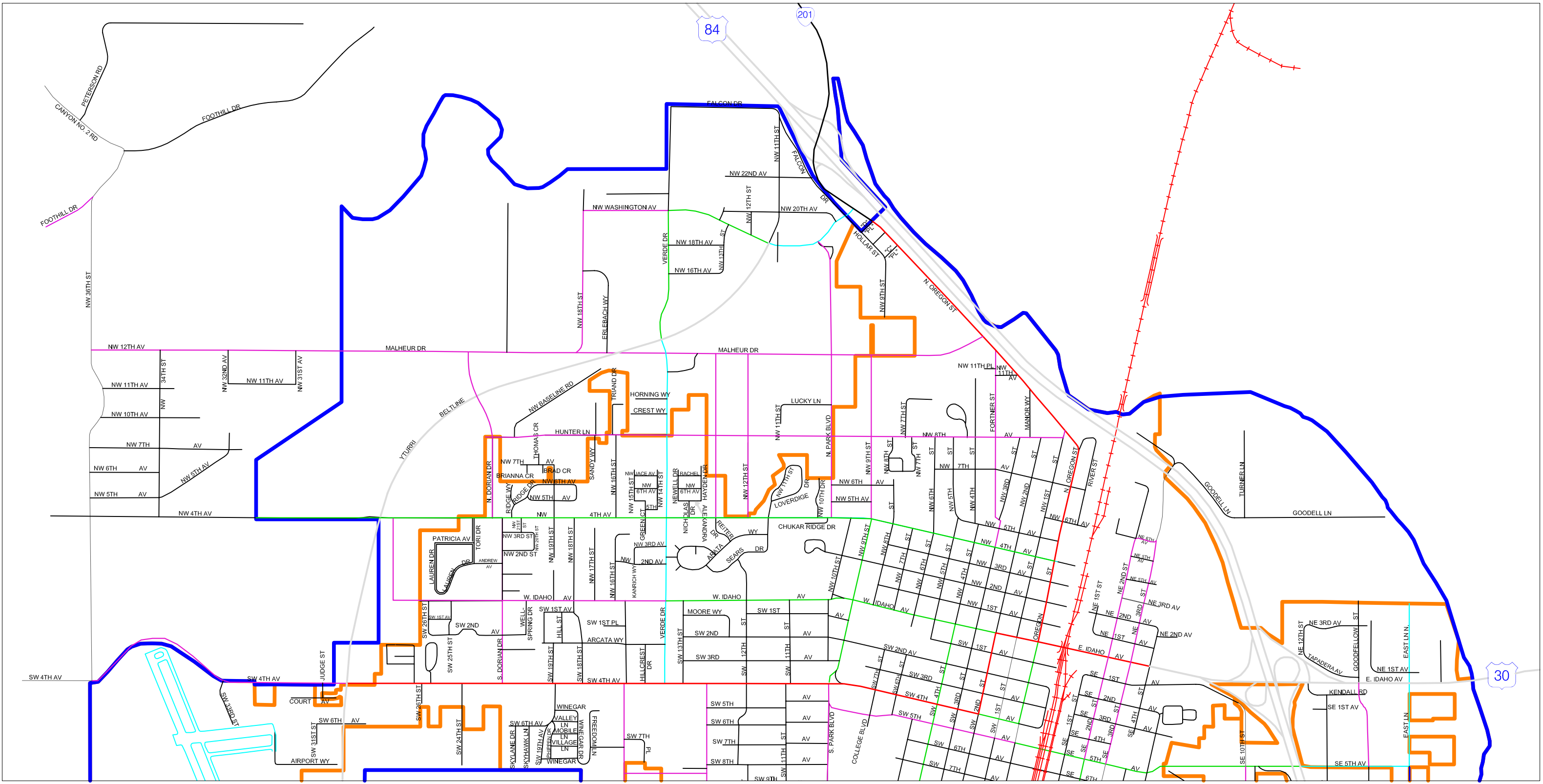

# City of Ontario Transportation System Plan

## LEGEND

- |                    |   |                 |   |
|--------------------|---|-----------------|---|
| State Highway      | — | Major Collector | — |
| Principal Arterial | — | Minor Collector | — |
| Minor Arterial     | — | Local Road      | — |



NOT TO SCALE

**Figure 3-1a**  
Existing Roadway Classification

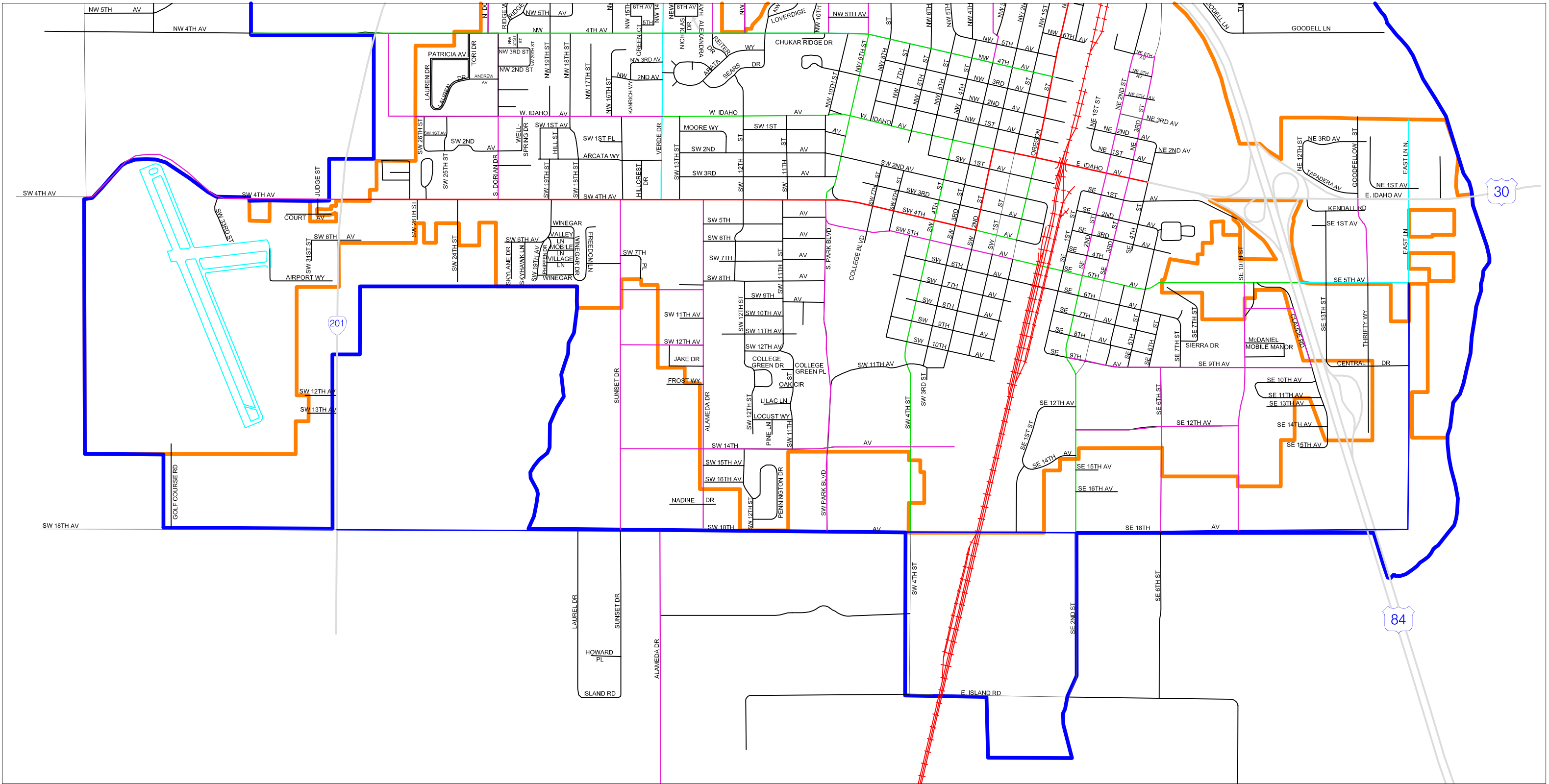

# City of Ontario Transportation System Plan

**LEGEND**

- |                    |  |                 |  |
|--------------------|--|-----------------|--|
| State Highway      |  | Major Collector |  |
| Principal Arterial |  | Minor Collector |  |
| Minor Arterial     |  | Local Road      |  |

NOT TO SCALE

**Figure 3-1b**  
Existing Roadway Classification



The state highways are known by their highway description name, route number, and state highway number. This information for the state highways in Ontario are listed below:

- I-84 – Old Oregon Trail, Oregon Highway Number 6
- US 30 – Ontario Spur, Oregon Highway Number 455
- OR 201 – Olds Ferry-Ontario Highway, Oregon Highway Number 455

The *1999 Oregon Highway Plan*<sup>2</sup> defines a state highway classification system in Policy 1A. The categories of highways defined in Policy 1A are summarized and defined below.

- Interstate Highways (NHS) provide connections to major cities, regions of the state, and other states. A secondary function in urban area is to provide connections for regional trips within the metropolitan area. The Interstate Highways are major freight routes and their objective is to provide mobility. The management objective is to provide for safe and efficient high-speed continuous-flow operation in urban and rural areas.
- Statewide Highways (NHS) typically provide inter-urban and inter-regional mobility and provide connections to larger urban areas, ports, and major recreation areas that are not directly served by Interstate Highways. A secondary function is to provide connections for intra-urban and intra-regional trips. The management objectives is to provide safe and efficient, high-speed, continuous-flow operation. In constrained and urban areas, interruptions to flow should be minimal. Inside Special Transportation Areas (STAs), local access may also be a priority.
- Regional Highways typically provide connections and links to regional centers, Statewide or Interstate Highways, or economic or activity centers of regional significance. The management objective is to provide safe and efficient, high-speed, continuous-flow operation in rural areas and moderate to high-speed operations in urban and urbanizing areas. A secondary function is to serve land uses in the vicinity of these highways. Inside STAs, local access is also a priority. Inside Urban Business Areas, mobility is balanced with local access.
- District Highways are facilities of county-wide significance and function largely as county and city arterials or collectors. They provide connections and links between small urbanized areas, rural centers and urban hubs, and also serve local access and traffic. The management objective is to provide for safe and efficient, moderate to high-speed continuous-flow operation in rural areas reflecting the surrounding environment and moderate to low-speed operation in urban and urbanizing areas for traffic flow and for pedestrian and bicycle movements. Inside STAs, local access is a priority. Inside Urban Business Areas, mobility is balanced with local access.
- Local Interest Roads function as local roads or arterials and serve little or no purpose for through traffic mobility. Some are frontage roads; some are not eligible for federal funding. Currently, these roads are District Highways or unclassified and will be identified through a

---

<sup>2</sup> 1999 Oregon Highway Plan, Oregon Department of Transportation, March 1999, pages 37 and 38.  
*City of Ontario Transportation System Plan*

process delineated according to Policy 2C. The management objective is to provide for safe and efficient, low to moderate speed traffic flow and for pedestrian and bicycle movements. Inside STAs, local access is a priority. ODOT will seek opportunities to transfer these roads to local jurisdictions.

### ***I-84 – Old Oregon Trail***

Interstate Highway 84 (Old Oregon Trail) is an Interstate Highway and Freight Route. I-84 runs diagonally through Ontario from northwest to southeast, approximately parallel to the Snake River. It has two interchanges providing access to the city. I-84 provides the fastest and most direct route to major metropolitan areas such as Portland, Oregon, and Boise, Idaho.

The northern interchange, Exit 374, lies along the north limits of Ontario. It connects with OR 201, the Yturri Beltline, around the west side of Ontario. The northern Interchange also provides access to downtown Ontario via Oregon Street.

The southern interchange, Exit 376, is Ontario's principal interchange. This interchange provides access to the heart of Ontario. It provides additional access to downtown Ontario as well as access across the Snake River into Idaho.

### ***US 30 – Ontario Spur***

US 30 overlaps I-84 from the northern study area limits (Exit 374) to the south interchange at (Exit 376). US 30 continues eastward on East Idaho Avenue into Idaho. This segment, a little over one half mile in length, is five lanes wide. US 30 is currently classified as a principal arterial in the Ontario classification system.

### ***Oregon 201 – Olds Ferry-Ontario Highway***

OR 201 is a district highway. Prior to the construction of the Yturri Beltline OR 201 used to zigzag through Ontario. From its southern entry into the study area, OR 201 runs northward along Cairo Boulevard. At Airport corner it used to turn eastward onto SW 4<sup>th</sup> Avenue (four lanes), northward onto SW 2<sup>nd</sup> Avenue (four lanes), eastward onto W Idaho Avenue (five lanes), and northward onto N Oregon Street (four lanes). With the construction of the Yturri Beltline, the alignment of OR 201 now runs along the Yturri Beltline from Cairo Boulevard to the northern I-84 interchange at Exit 374. The old OR 201 alignment now belongs to the City of Ontario.

OR 201 is classified as a principal arterial. It provides north-south access to communities in Oregon. South of the City it connects with Highways 26 and 20 that provide east-west access through Eastern and Central Oregon.

OR 201/Yturri Beltline has between two and four lanes in the study area with additional turn lanes at major intersections. Several sections of this highway have a center left turn lane. The posted speed limit ranges from 45 mph to 55 mph.

### **3.4.3. Non-Highway Principal and Minor Arterials**

The following is a list of non-highway principal arterials in the City of Ontario:

- Oregon Street from Dork Canal to East Idaho Avenue
- W. Idaho Avenue / E. Idaho Avenue from SW 2<sup>nd</sup> Street to SE 4<sup>th</sup> Street
- SW 2<sup>nd</sup> Street from W. Idaho Avenue to SW 4<sup>th</sup> Avenue
- SW 4<sup>th</sup> Avenue from SW 2<sup>nd</sup> Street to Highway 201

There are a number of minor arterials within the City of Ontario as listed below:

- SW 18th Avenue from West UGB to East Lane
- NW Washington Avenue from Yturri Beltline to N Oregon Street
- East Lane from East Idaho Avenue to SE 18<sup>th</sup> Avenue
- SE 5<sup>th</sup> Avenue from I-84 to East Lane
- Verde drive from SW 4<sup>th</sup> Avenue to Yturri Beltline

### **3.4.4. Major and Minor Non-Highway Collectors**

The remainder of Ontario's non-highway arterial system is made up of major and minor collectors as listed below:

- NE 2nd Street from NE 6<sup>th</sup> Avenue to Idaho Avenue
- NE 3rd Street from NE 6<sup>th</sup> Avenue to Idaho Avenue
- NW 4th Avenue from West UGB to North Oregon Street
- Idaho Avenue from West of SW 26<sup>th</sup> Street to SW 2<sup>nd</sup> Street
- SE / SW 5th Avenue from I-84 to South Park Boulevard
- NE 6th Avenue from NE 2nd Street to NE 3rd Street
- NW 8th Avenue from West of Dorian Drive to Oregon Street
- SW Alameda Drive from SW 4th Avenue to South UGB
- Dorian Drive from SW 4<sup>th</sup> Avenue to Malheur Drive
- Fortner Street from Oregon Street to NW 4th Avenue
- Malheur Drive from West UGB to North Oregon Street
- Park Boulevard from NW Washington Avenue to NW 4<sup>th</sup> Avenue
- SW 4th Street from West Idaho Avenue to SW 18<sup>th</sup> Avenue
- SE 2nd Street from East Idaho Avenue to SE 18<sup>th</sup> Avenue
- Park Boulevard from SW 4th Avenue to SW 18<sup>th</sup> Avenue
- NW 9th Street from West Idaho Avenue to NW 8th Avenue
- SW 9th Street from SW 4th Avenue to Idaho Avenue

- Oregon Street from Idaho Avenue to SW 4th Avenue
- Sunset Drive from SW 4th Avenue to SW 18th Avenue
- Verde Drive from NW Washington Avenue to SW 4th Avenue
- SE 10th Street from SE 5<sup>th</sup> Avenue to SE 18th Avenue
- SE 3rd Street from East Idaho Avenue to SE 5<sup>th</sup> Avenue
- Goodfellow from East Idaho Avenue to SE 5<sup>th</sup> Avenue
- SE 9<sup>th</sup> Avenue from SE 2<sup>nd</sup> Street to Claude Road
- Claude Road from SE 9<sup>th</sup> Avenue to SE 6<sup>th</sup> Avenue
- SE 6<sup>th</sup> Avenue from Claude Road to SE 10<sup>th</sup> Street (future street)
- SE 12<sup>th</sup> Avenue from SE 10<sup>th</sup> Street to SE 2<sup>nd</sup> Street
- SE 6<sup>th</sup> Street from SE 9<sup>th</sup> Avenue to SE 18<sup>th</sup> Avenue
- SW 14<sup>th</sup> Avenue from Alameda Drive to East of SW 4<sup>th</sup> Street
- SW 14<sup>th</sup> Avenue from Alameda Drive to Sunset Drive (future street)
- Reiter drive from NW 4<sup>th</sup> Avenue to Malheur Drive
- NW 12<sup>th</sup> Street from NW 4<sup>th</sup> Avenue to Malheur Drive (future street)
- NW 18<sup>th</sup> Street from Malheur Drive to NW Washington Avenue
- NW Washington Avenue from NW 18<sup>th</sup> Street to Yturri Beltline
- Future Street West of SW 26<sup>th</sup> Street from West Idaho Avenue to NW 4<sup>th</sup> Avenue
- SW 4<sup>th</sup> Avenue from Highway 201 to West UGB
- SW 4<sup>th</sup> Avenue from South Oregon Street to SW 2<sup>nd</sup> Street
- Local Collector system between Alameda and Sunset

### **3.5. BRIDGES**

The Oregon Department of Transportation maintains an up to date inventory and appraisal of Oregon bridges. Part of this inventory involves the evaluation of three mutually exclusive elements of bridges. One element identifies which bridges are structurally deficient. This is determined based on the condition rating for the deck, superstructure, substructure, or culvert and retaining walls. It may also be based on the appraisal rating of the structural condition or waterway adequacy. Another element identifies which bridges are functionally obsolete. This element is determined based on the appraisal rating for the deck geometry, underclearances, approach roadway alignment, structural condition, or waterway adequacy. The third element summarizes the sufficiency ratings for all bridges. The sufficiency rating is a complex formula which takes into account four separate factors to obtain a numeric value rating the ability of a bridge to service demand. The scale ranges from 0 to 100 with higher ratings indicating optimal conditions and lower ratings indicating insufficiency. Bridges with ratings under 55 may be nearing a structurally deficient condition. In more general terms, a rating under 55 may indicate that significant maintenance is needed or that replacement should be planned. The exception to this are bridges that were built to a much older standard that are in good condition but do not meet today's design standards. These types of bridges can rate fairly low and under 55. The important factor here is that there are no structural integrity issues and loading problems that limit the type of vehicle and weight that can cross the structure.

There are 9 bridges within the Ontario planning area that are rated by ODOT. Of these 9 bridges, 8 are maintained by ODOT, and the remaining one by Malheur County.

Table 1 summarizes the ratings of the nine bridges rated by ODOT within the City of Ontario UGA. As shown in Table 3-1, only one bridge is classified as functionally obsolete with a sufficiency rating of 53.5. The functionally obsolete bridge is located along SE 5<sup>th</sup> Avenue at I-84. Figures 3-2a and 3-2b show the locations of the bridges within the study area.

**Table 3-1. ODOT Bridge Ratings**

Map No.	Nimbus Number	Road	Waterway/Roadway Crossed	Maintenance Responsibility	ODOT Sufficiency
1	08395	I-84	Dork Canal	ODOT	83
2	08396A	I-84	Drainage Ditch	ODOT	83
3	08397E	I-84 Eastbound	UPRR	ODOT	85.6
4	08397W	I-84 Westbound	UPRR	ODOT	85.6
5	18097	US 30	Idaho Avenue Interchange	ODOT	100
6	18724	SW 18 <sup>th</sup> Avenue	UPRR	Malheur County	99.9
7	08398E	I-84 Eastbound	Grigg Road	ODOT	94.8
8	08398W	I-84 Westbound	Grigg Road	ODOT	94.8
9	08400	SE 5 <sup>th</sup> Avenue	I-84	ODOT	53.5

### **3.6. INTERSECTION TRAFFIC CONTROL AND LANE CHANNELIZATION**

Figures 3-3a and 3-3b show the locations of the study area intersections. Figure 3-4 shows the existing intersection traffic control and lane geometry for each of the study area intersections.

### **3.7. P.M. PEAK HOUR TRAFFIC VOLUMES**

P.M. peak hour turning movement counts at the study area intersections were collected by H. Lee & Associates in August and September 2004. These traffic counts were adjusted to represent the 30<sup>th</sup> highest hour traffic volumes. Figure 3-5 shows the 2004 Existing P.M. peak hour traffic volumes at the study area intersections.

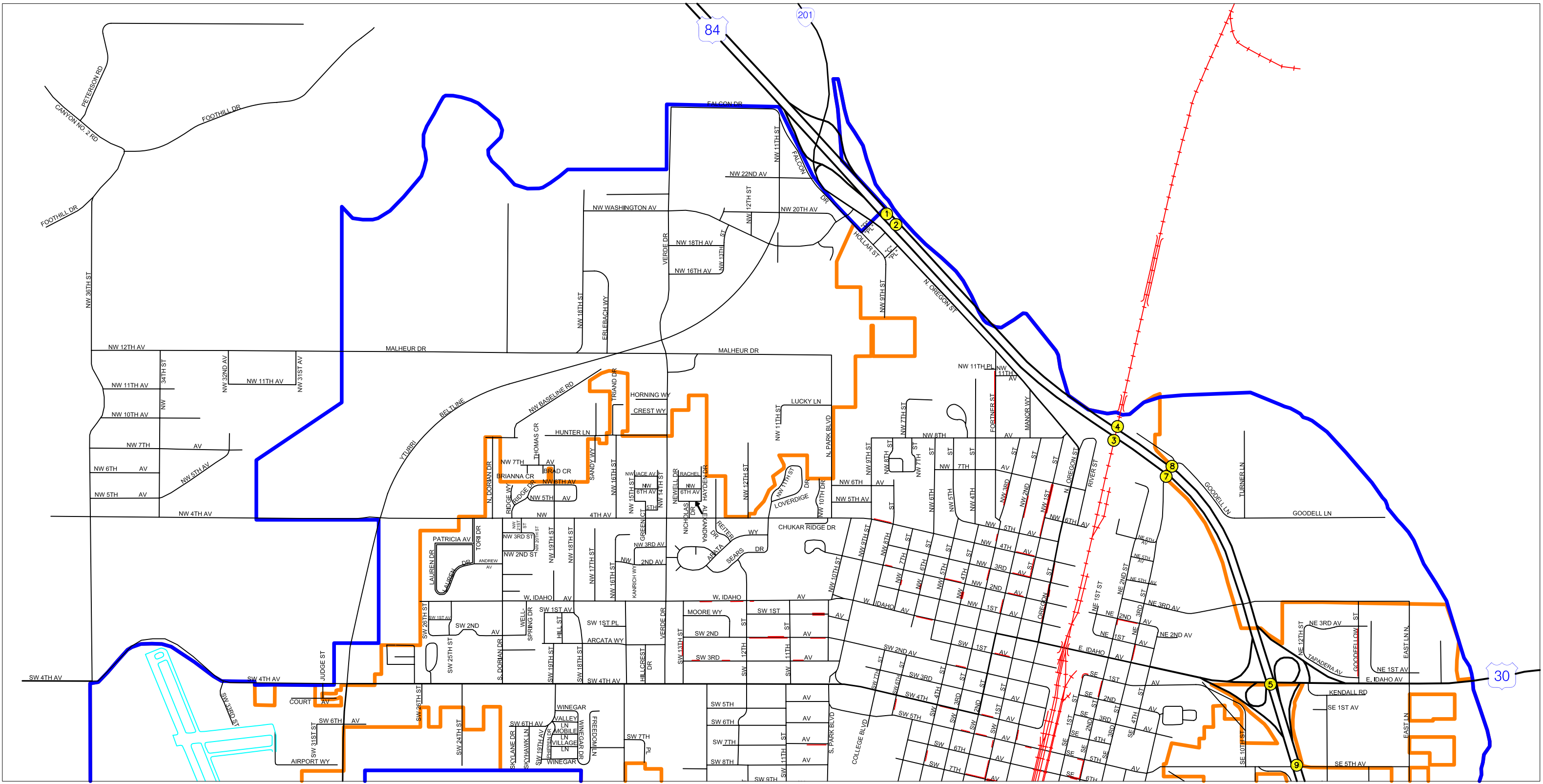

# City of Ontario Transportation System Plan

**LEGEND**  
 Bridge Locations



**Figure 3-2a**  
 Bridge Locations

NOT TO SCALE

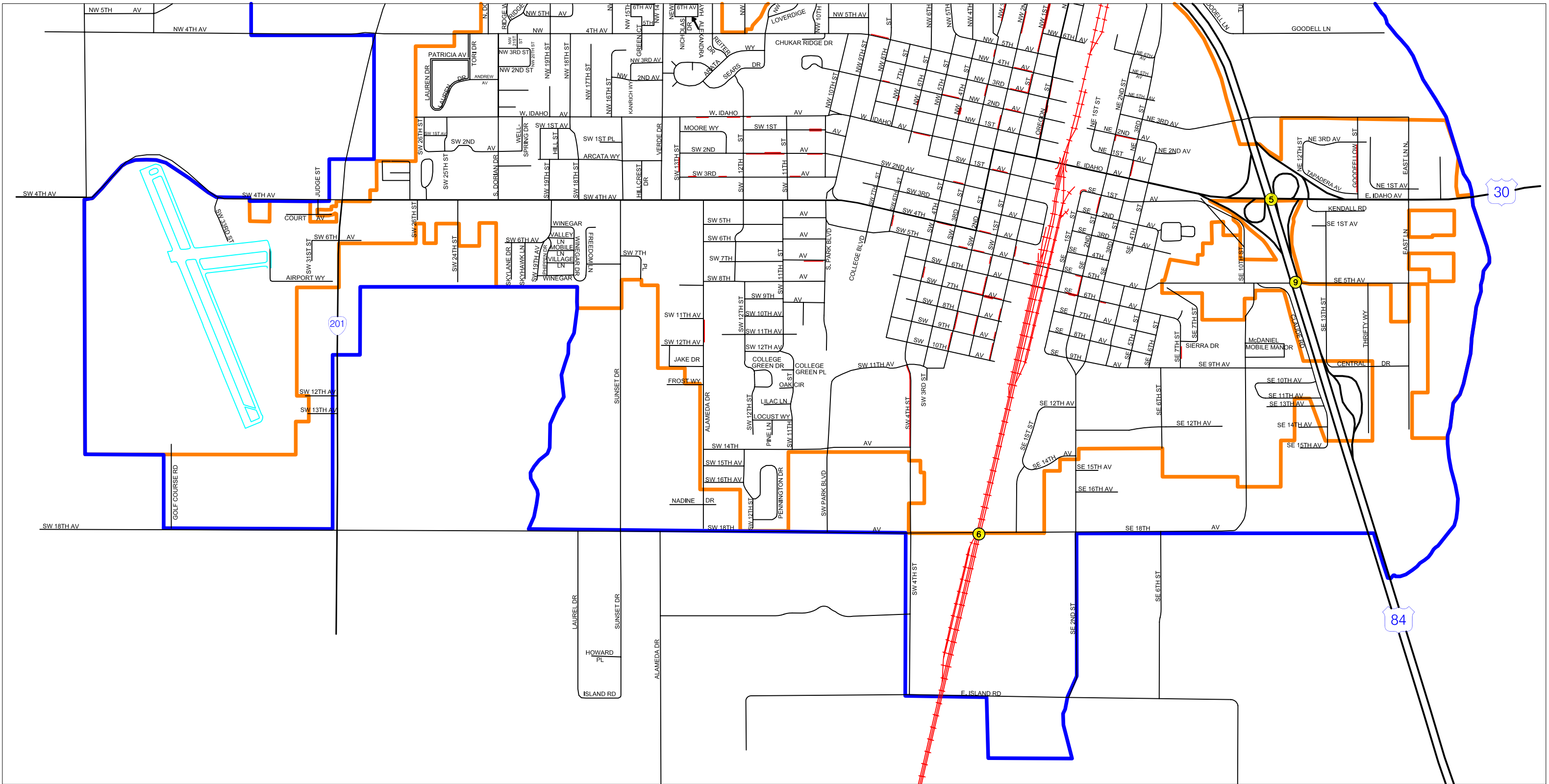

# City of Ontario Transportation System Plan

**LEGEND**  
 Bridge Locations ①

**Figure 3-2b**  
 Bride Locations

NOT TO SCALE

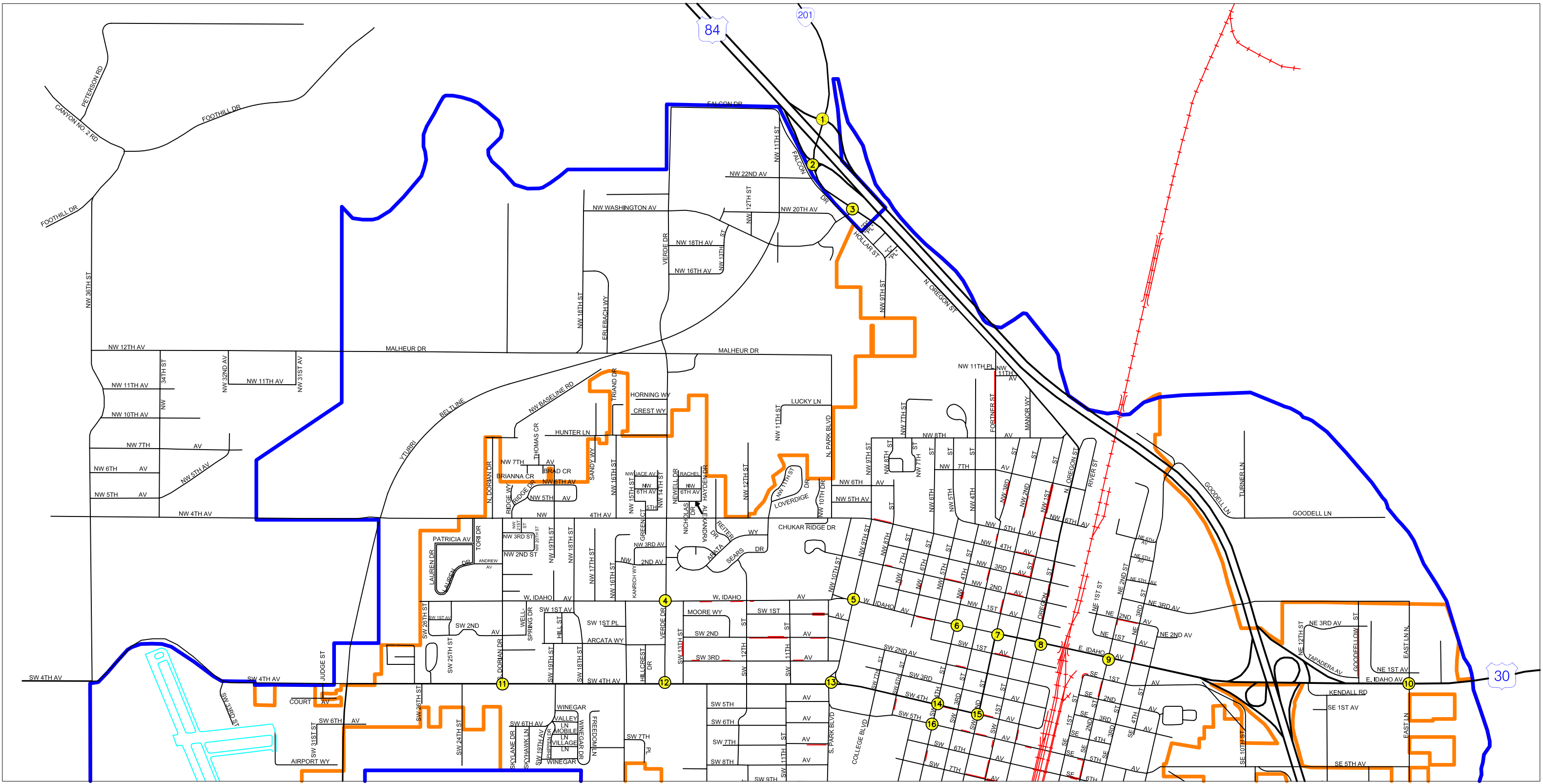

# City of Ontario Transportation System Plan

**LEGEND**  
 Study Area Intersection ①

**Figure 3-3a**  
 Location of Study Area Intersections



NOT TO SCALE



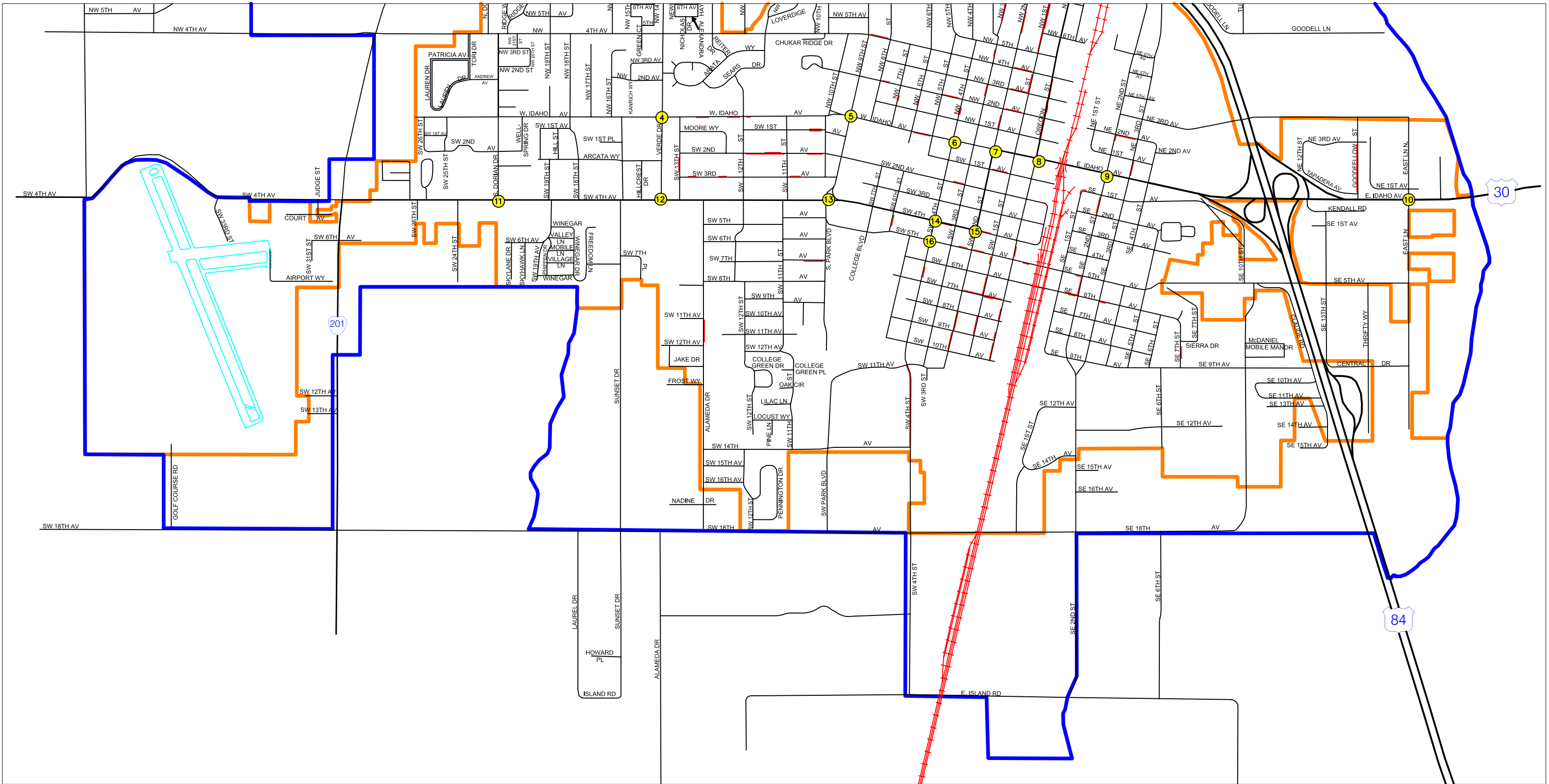

# City of Ontario Transportation System Plan

**LEGEND**  
 Study Area Intersection ●

**Figure 3-3b**  
 Location of Study Area Intersections

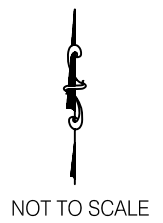

NOT TO SCALE

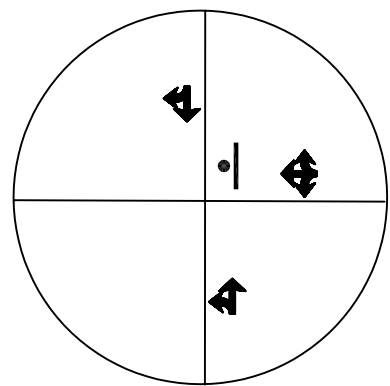

Intersection 1  
OR 201/I-84 WB Ramps

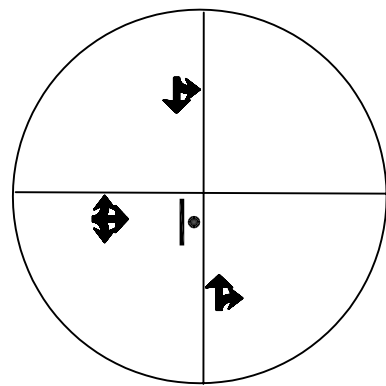

Intersection 2  
OR 201/I-84 EB Ramps

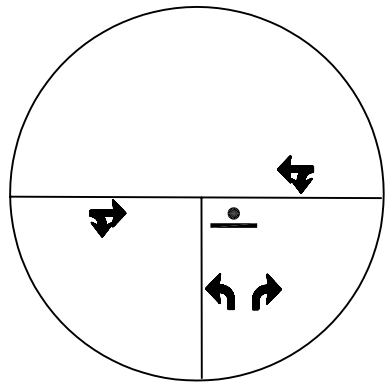

Intersection 3  
Oregon St/Washington Av

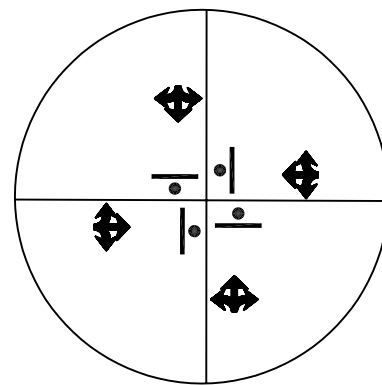

Intersection 4  
West Idaho Av/Verde Dr

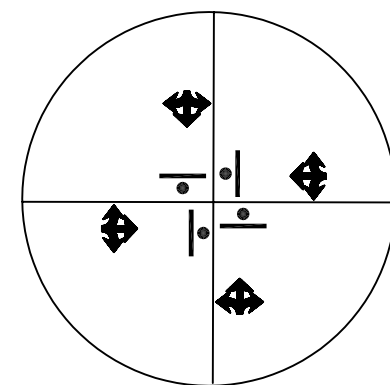

Intersection 5  
West Idaho Av/SW 9th St

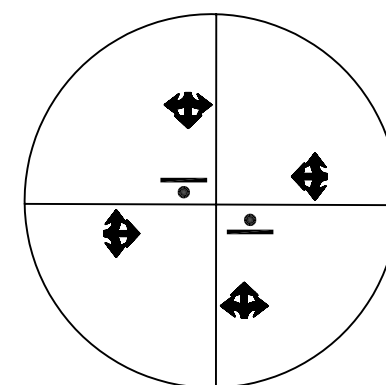

Intersection 6  
West Idaho Av/SW 4th St

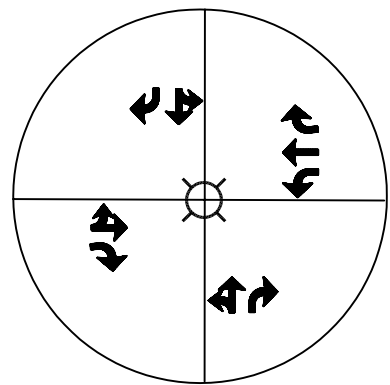

Intersection 7  
West Idaho Av/SW 2nd St

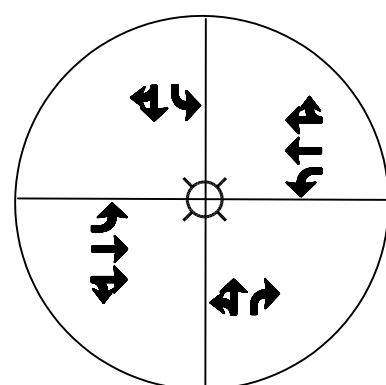

Intersection 8  
West Idaho Av/Oregon St

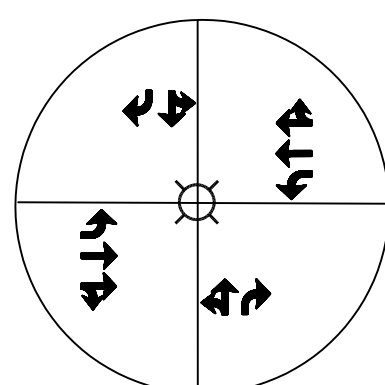

Intersection 9  
East Idaho Av/East 2nd St

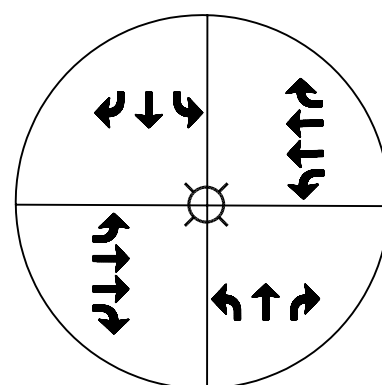

Intersection 10  
East Idaho Av/East Lane

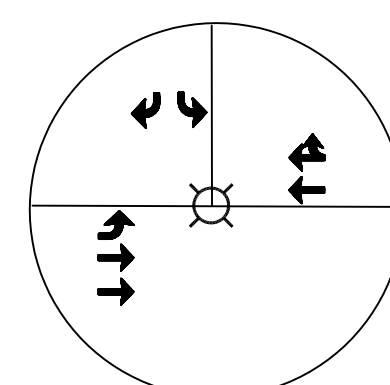

Intersection 11  
SW 4th Av/Dorian Dr

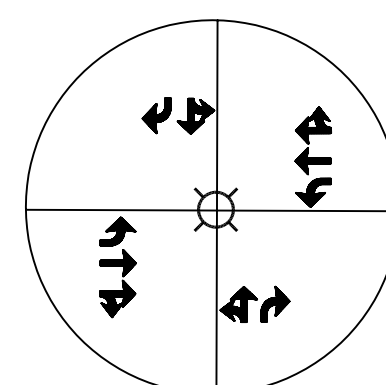

Intersection 12  
SW 4th Av/Verde Dr

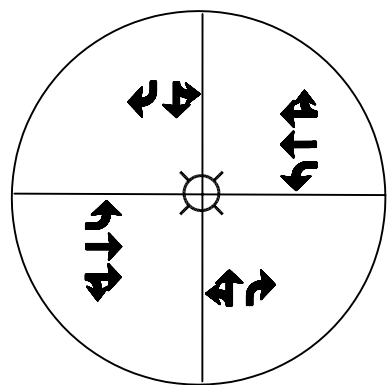

Intersection 13  
SW 4th Av/SW 9th St

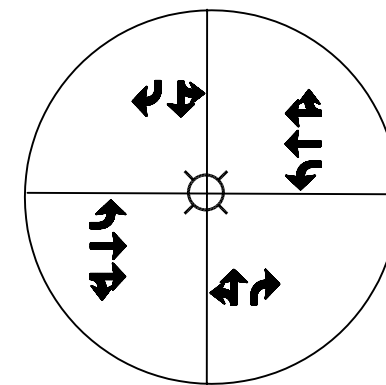

Intersection 14  
SW 4th Av/SW 4th St

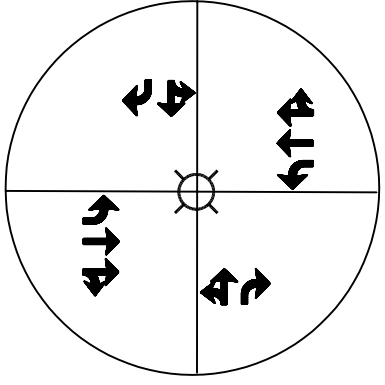

Intersection 15  
SW 4th Av/SW 2nd St

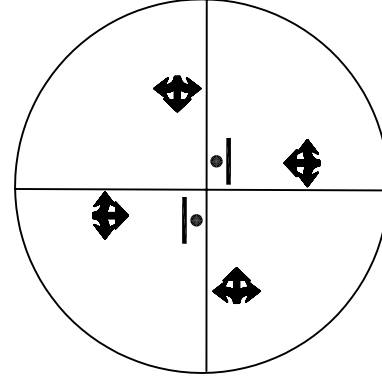

Intersection 16  
SW 5th Av/SW 4th St

# City of Ontario Transportation System Plan

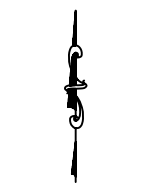

NOT TO SCALE

## LEGEND

Lane Usage

Stop Sign

Traffic Signal



**Figure 3-4**  
Existing Lane Configuration  
and Traffic Control

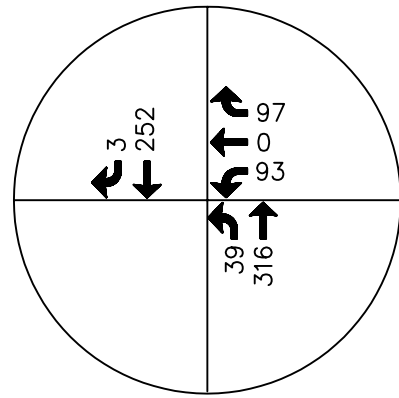

Intersection 1  
OR 201/I-84 WB Ramps

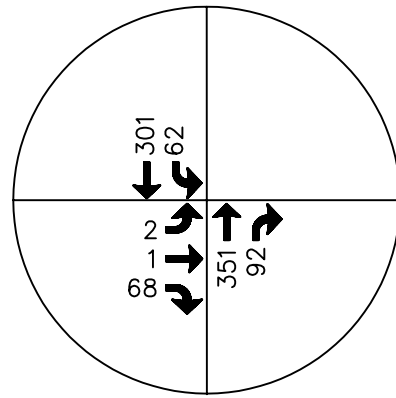

Intersection 2  
OR 201/I-84 EB Ramps

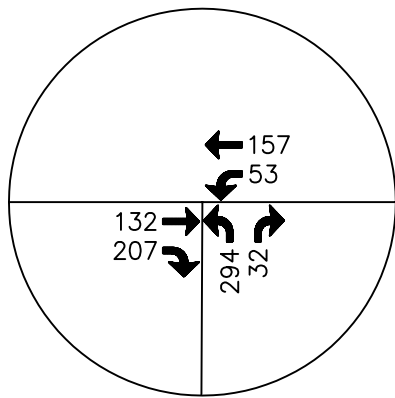

Intersection 3  
Oregon St/Washington Av

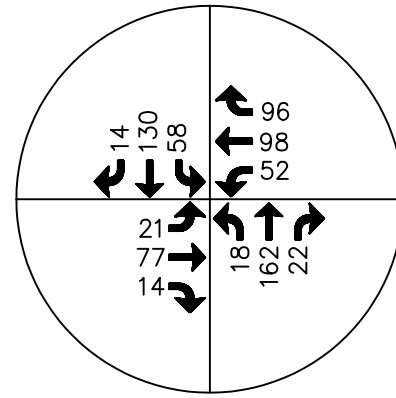

Intersection 4  
West Idaho Av/Verde Dr

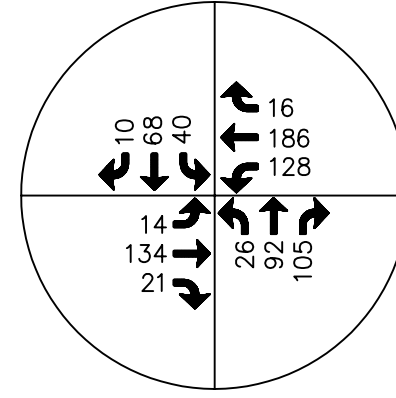

Intersection 5  
West Idaho Av/SW 9th St

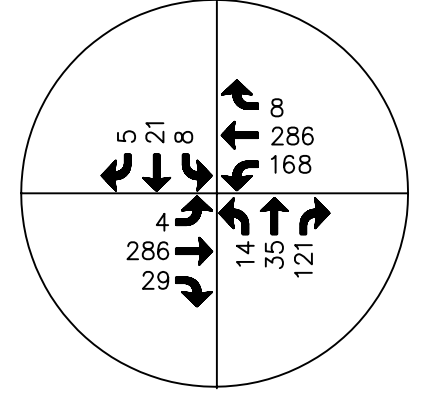

Intersection 6  
West Idaho Av/SW 4th St

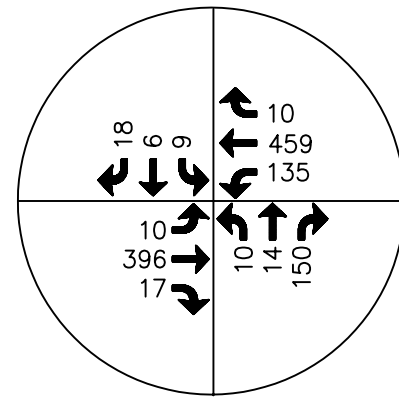

Intersection 7  
West Idaho Av/SW 2nd St

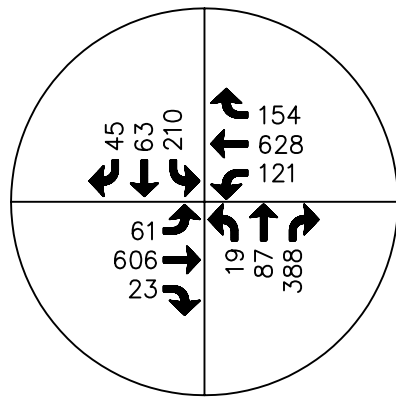

Intersection 8  
West Idaho Av/Oregon St

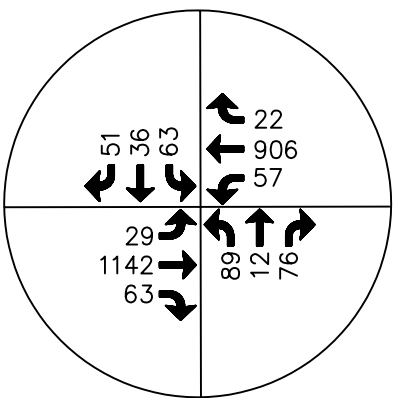

Intersection 9  
East Idaho Av/East 2nd St

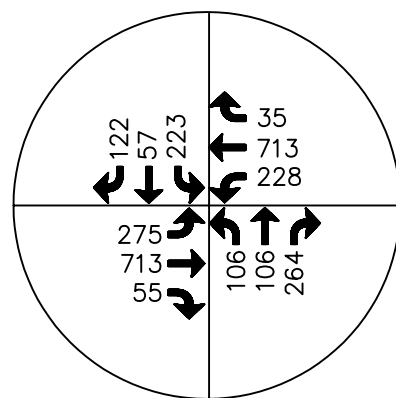

Intersection 10  
East Idaho Av/East Lane

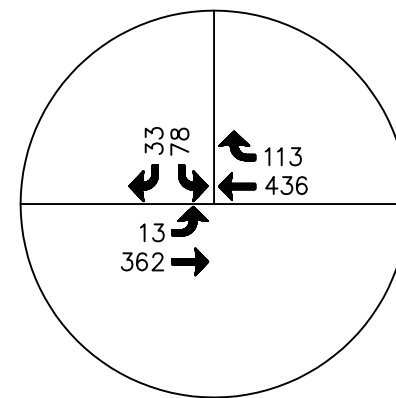

Intersection 11  
SW 4th Av/S. Dorian Dr

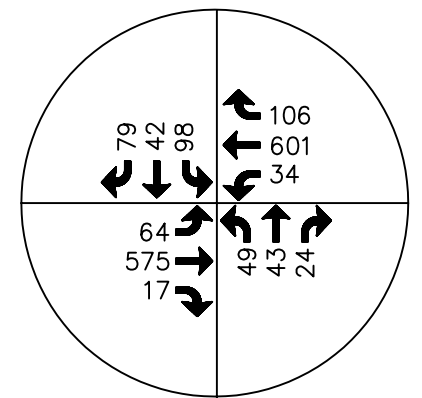

Intersection 12  
SW 4th Av/Verde Dr

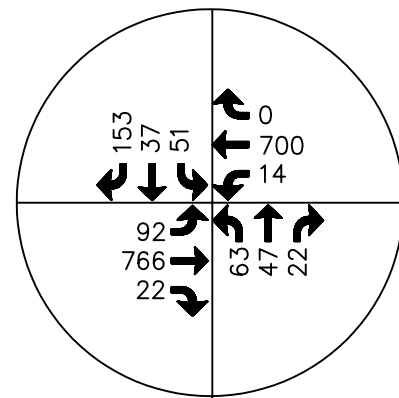

Intersection 13  
SW 4th Av/SW 9th St

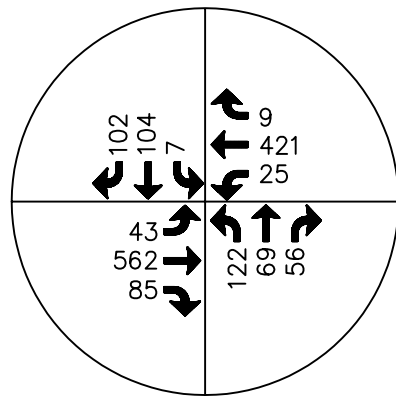

Intersection 14  
SW 4th Av/SW 4th St

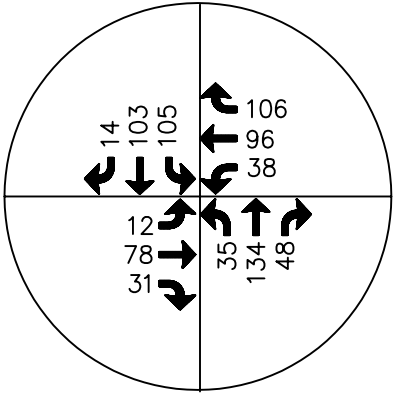

Intersection 15  
SW 4th Av/SW 2nd St

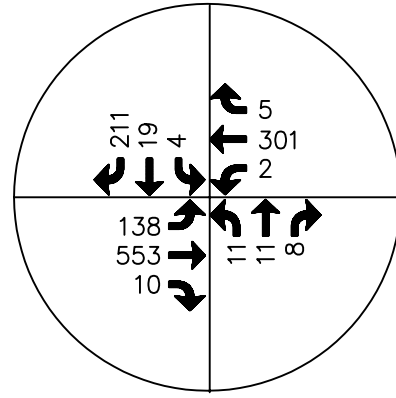

Intersection 16  
SW 5th Av/SW 4th St

# City of Ontario Transportation System Plan



NOT TO SCALE

## LEGEND

PM Peak Hour  
Traffic Volume

**Figure 3-5**  
Existing Weekday P.M.  
Peak Hour Traffic Volumes

## **3.8. PEDESTRIAN AND BICYCLE FACILITIES**

### **3.8.1. Pedestrian System**

The most basic transportation option is walking. Walking is the most popular form of exercise in the United States and can be performed by people of all ages and all income levels; however, it is not often considered as a means of travel. This is mainly because pedestrian facilities are generally an afterthought and not planned as an essential component of the transportation system.

The relatively small size of the City of Ontario indicates that walking could be employed regularly to reach a variety of destinations. The City of Ontario is a compact city with most destinations within two miles; and on foot, the distance commonly walked is around one-half mile. Encouraging pedestrian activities may not only decrease the use of the personal automobile, but may also provide benefits for retail businesses.

Developed facilities for pedestrian travel are not complete in the City of Ontario planning area. Figures 3-6a and 3.6b show the existing walkway inventory. As shown in Figures 3-6a and 3-6b, sidewalks exist in most areas of Ontario; however, a common condition is that both local roads and arterials have many missing sections of sidewalks. Due to these missing sections, the pedestrian facilities in Ontario are incomplete and somewhat disjointed.

In Ontario, the sidewalks are often five feet wide with concrete. Walking is inhibited by a few physical barriers: the state highways, the railroads, missing links in sidewalks, dispersed developments, and poor sidewalk maintenance. Where sidewalks have been provided, many of the older sections of sidewalk are in a state of disrepair due to excessive weathering; and most of the intersections do not have wheelchair ramps.

A unique opportunity exists along many of the City of Ontario roads. The unusual width of the road may allow the placement of new sidewalks within the paved roadway. This would accomplish several goals: slow excessive motorist speeds through neighborhoods, reduce the amount of asphalt needed for construction or maintenance of the street, and provide needed sidewalks in areas where pedestrians currently walk unprotected within the street.

### **3.8.2. Bike System**

Like pedestrians, bicyclists are often overlooked when considering transportation facilities. People have been slow to consider cycling as a serious form of transportation. However, cycling is a very efficient mode of travel. Bicycles take up little space on the road and parking space, do not contribute to air or noise pollution, and offer relatively higher speeds than walking. Because of the small size of the City of Ontario, a cyclist can travel to any destination in town within a matter of minutes.

Bicycling should be encouraged to reduce the use of automobiles for short trips and, as a result, diminish some of the negative aspects of urban growth. Noise, air pollution, and traffic congestion

could be mitigated if more short trips were taken by bicycle or on foot. Typically, a short trip that would be taken by bicycle is around two miles, and most of the destinations in the City of Ontario fall within two miles of one another.

The width of many of the City of Ontario local streets easily accommodates bicycle traffic, as well as motor vehicle traffic on shared roadways. Figures 3-7a and 3-7b show the existing bikeway inventory. Most of these local streets are residential and have low traffic volumes. The major limitation to bicycle travel in the City of Ontario is the same as one of the most significant problems for motorists: the lack of connecting streets for through travel. Another impediment to bicycle use is the lack of parking and storage facilities for bikes throughout the City of Ontario area.

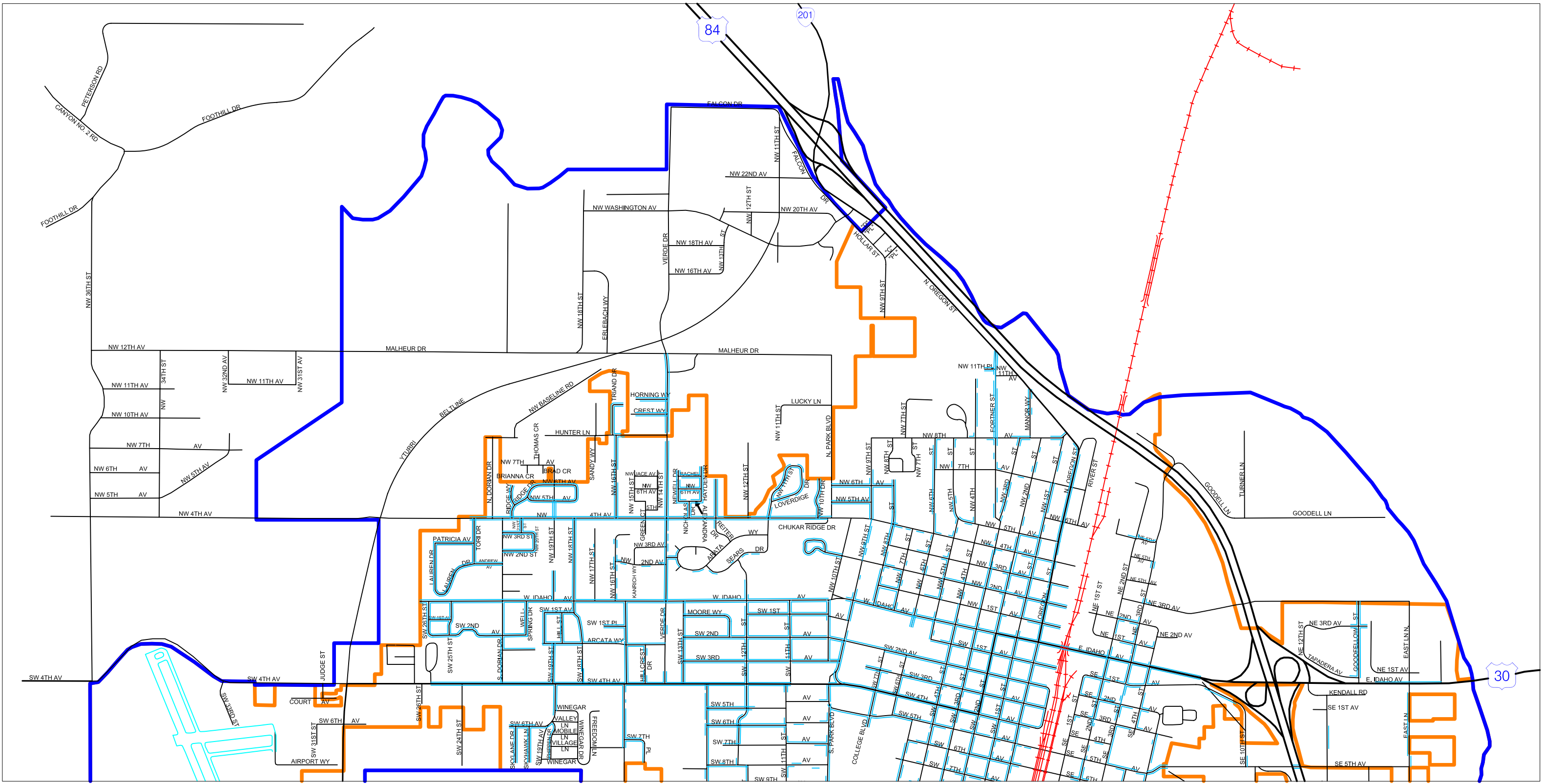

# City of Ontario Transportation System Plan

**LEGEND**  
 Sidewalk 

**Figure 3-6a**  
 Existing Sidewalk Inventory

NOT TO SCALE

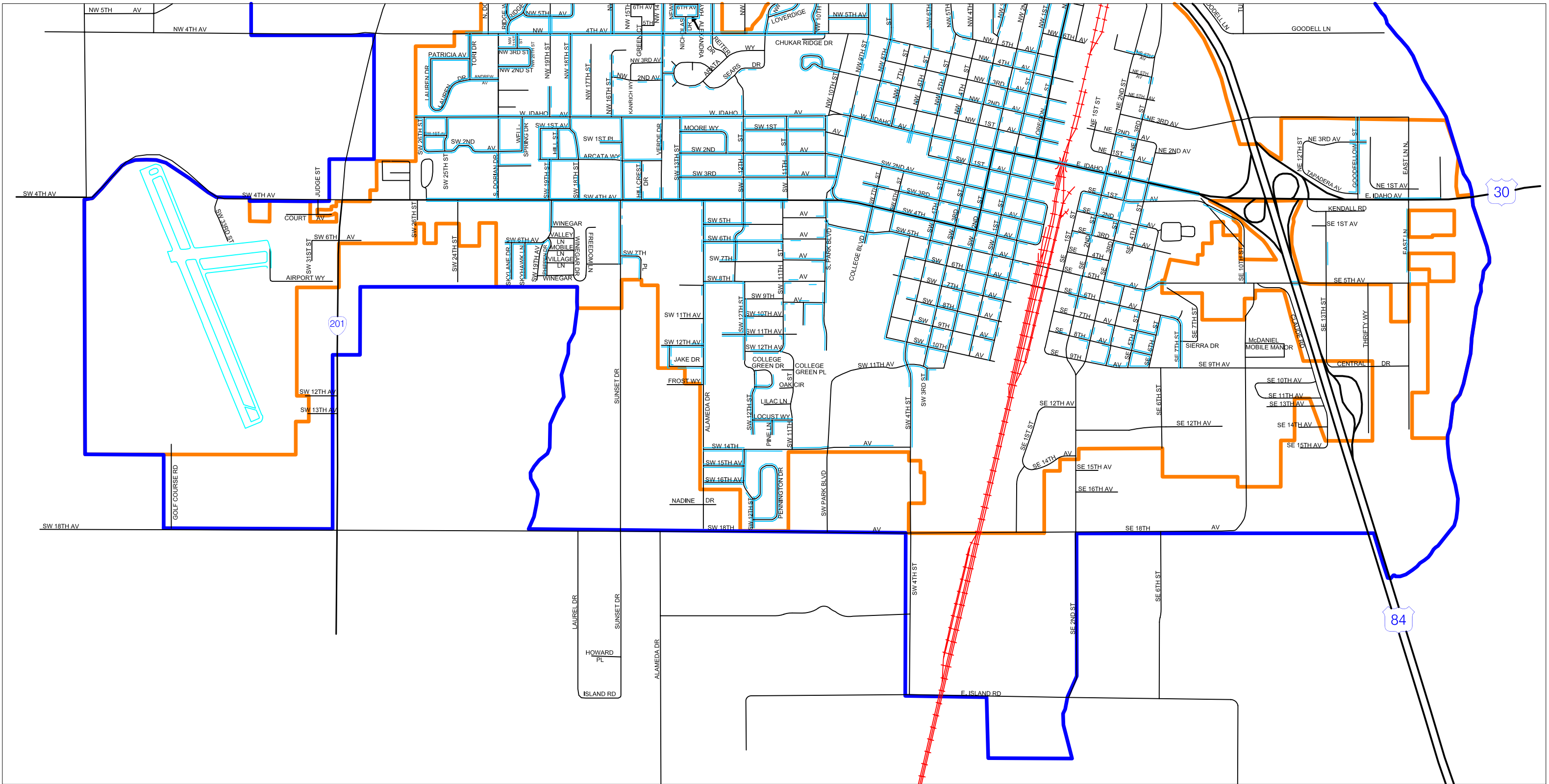

# City of Ontario Transportation System Plan

**LEGEND**  
 Sidewalk ———

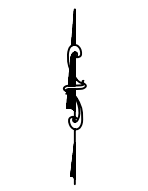

NOT TO SCALE

**Figure 3-6b**  
 Existing Sidewalk Inventory

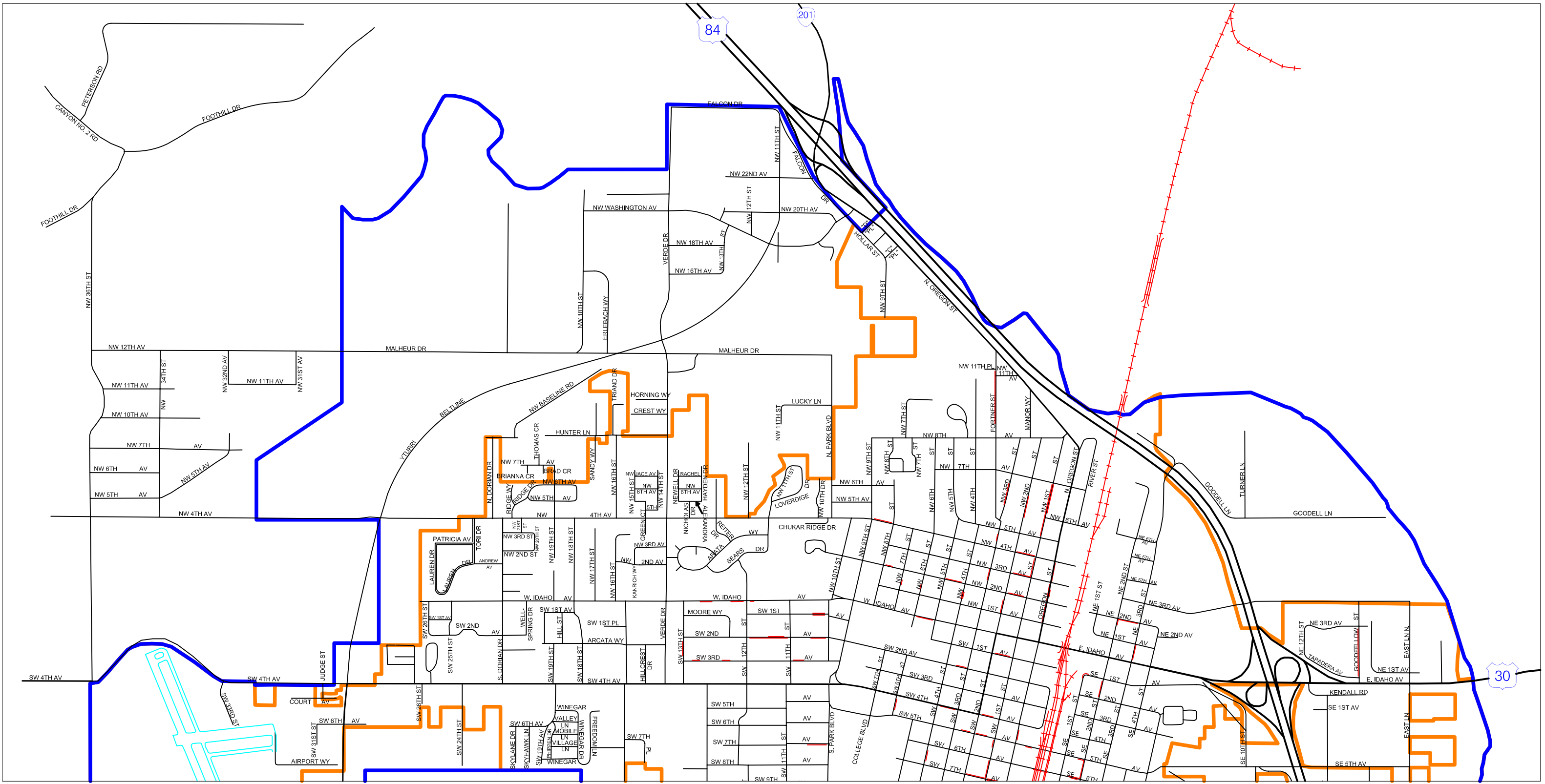

# City of Ontario Transportation System Plan

**LEGEND**  
Bike Lane



**Figure 3-7a**

Bike Facility Inventory



NOT TO SCALE



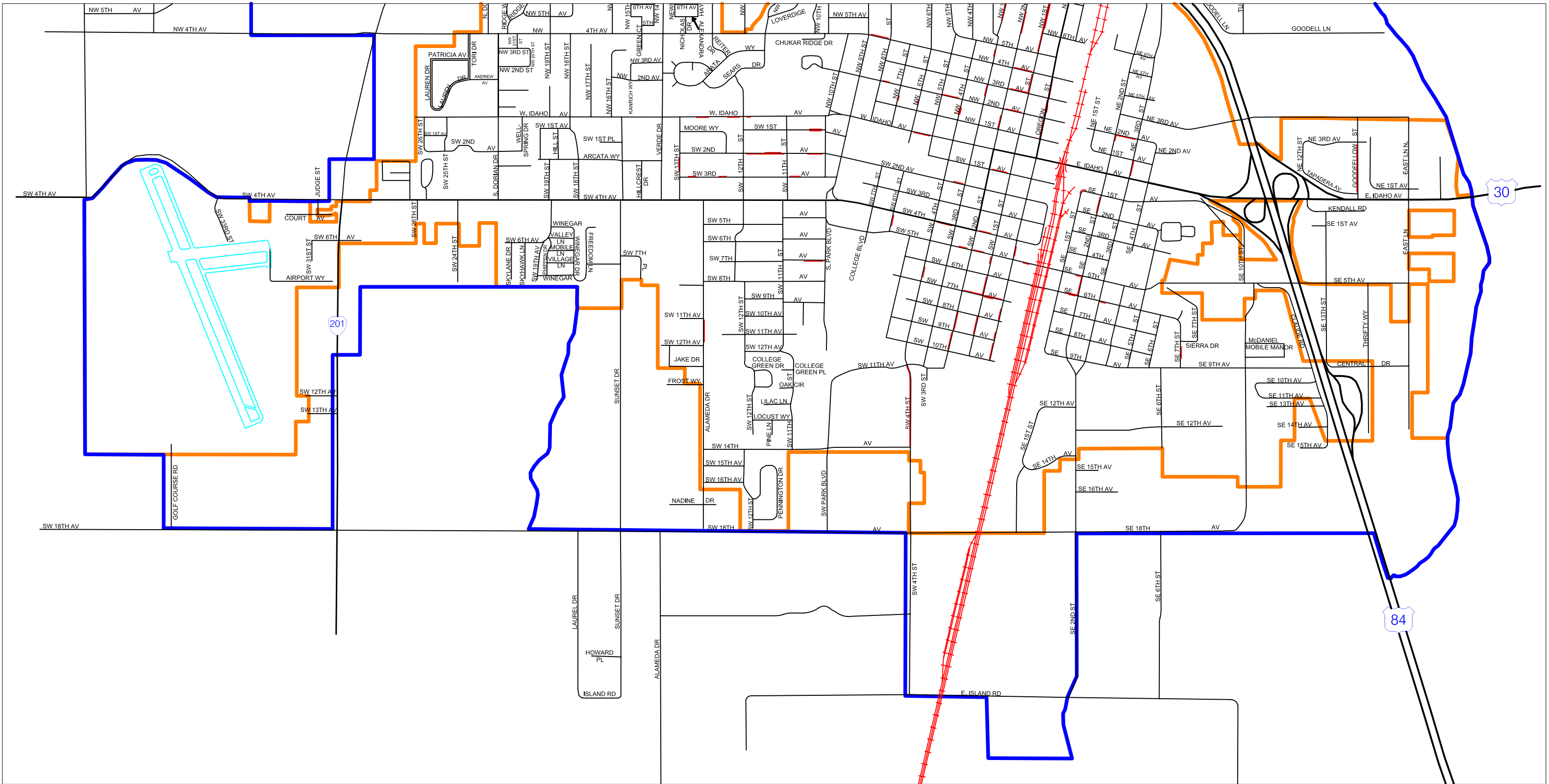

# City of Ontario Transportation System Plan

**LEGEND**  
 Bike Lane ———

**Figure 3-7b**  
 Bike Facility Inventory

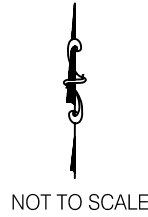

NOT TO SCALE

### **3.9. RAIL SERVICE**

#### **3.9.1. Railroad Passenger Service**

Amtrak rail passenger service in Ontario was discontinued in 1997. Originally, Amtrak offered daily service, but reduced that to three times per week, and eventually eliminated service completely. Amtrak now offers bus service as part of its Thruway Motor Coach. Amtrak's current schedule shows that the Thruway Motor Coach operates three times a day from Portland to Ontario and twice a day for the westbound direction from Ontario to Portland.

During its final years, Amtrak's Pioneer offered service at Ontario three times a week with trains in each direction. The Pioneer, which ran from Seattle to Denver, previously operated daily in both directions. With the reduction in service to three times per week, passenger boarding in Ontario fell from approximately 4,600 (1985) to an average of approximately 3,000 since the early 1990s.

#### **3.9.2. Rail Freight Service**

Rail freight service in Ontario is provided by the Union Pacific Railroad (UP). The UP's system extends from Washington to California to Illinois to Louisiana. The UP's mainline connecting Washington and Oregon with the remainder of its system runs through Ontario. Even freight originating in Portland and destined for California travel runs through Ontario.

The UP mainline through Ontario is one of the more intensely used rail lines in Oregon. In 1990, the line carried over 44 million tons (24.62 million tons westbound and 19.61 million tons eastbound). Estimates by ODOT indicate this volume could increase by four to five percent annually.

The recent merger of the UP and the Southern Pacific Lines (SP) may have an impact on the volumes through Ontario on the UP mainline. The merger could be significant because it provides new routing options for SP's Oregon and Washington customers. At present, SP freight originating in Oregon and Washington goes south through Eugene and Klamath Falls before continuing east through Salt Lake City and the eastern portions of the SP system.

Malheur County produces relatively modest amounts of rail freight traffic in comparison to the volume of rail freight traffic passing through Ontario. The *Oregon Rail Freight Plan* indicates less than one-half million tons annually is destined for, or originates in, Malheur County. Most of Malheur County's rail freight traffic originates in Ontario, although other shippers are present at Vale and Nyssa. Agricultural commodities, such as grain and onions, represent the bulk of the freight tonnage.

Mainline speed limits on the UP line through Ontario are 79 miles per hour for passenger trains and 70 miles per hour for freight trains. ODOT records indicate an average of about 36 trains per day for the year.

The railway runs northwest–southeast through Ontario, cutting the city in half. Sidings are located along the rail line adjacent to the major agricultural companies in the city. There are only four crossings: Idaho Avenue (US 30), SE 18<sup>th</sup> Avenue, SE 5<sup>th</sup> Avenue, and SE 6<sup>th</sup> Avenue. Of these, the Idaho Avenue and SE 18<sup>th</sup> Avenue crossings are grade-separated. Consequently, train traffic can block east-west access creating significant congestion.

### **3.10. TRUCK FREIGHT SERVICE**

Almost all of the goods purchased by Ontario residents are transported into the city as truck freight. Truck freight plays a major role in the local economy, not only for local consumption, but also for the export of commodities to markets elsewhere. Many of the city’s largest employers rely heavily on trucks to ship their products. At the same time, a key concern in Ontario is the high volume of truck traffic on the major corridors through town. Increasing truck traffic, both within and through the city of Ontario, has added to significant congestion along primary routes in the city. To alleviate some of this truck traffic, the Yturri Beltline was constructed around the west end of the City. It provides truck access from I-84 around the west end of Ontario to the south along OR 201.

As part of the June 1998 Ontario Transportation Solutions Project, a survey of several agricultural and industrial interests was conducted to help determine truck volumes, origins, and destinations. The six companies located in Ontario or nearby communities included: the Northwest Agricultural Coop Association (NACA), Abbot Transportation, Simplot Fertilizer Company, Americold Corporation, Ore-Ida Foods, Inc., and Woodgrain Millwork. Most of the Ontario companies are located in the industrial portion of the city along the railway and the highways. These businesses generate significant traffic with five major agricultural processors reporting movements that can combine to more than 325 trucks per day. Seasonally, Ontario experiences significant additional truck traffic as produce trucks from area farms access the storage sheds, packing plants, and food processing facilities located within the city. The Yturri Beltline has helped alleviate some of the truck traffic through the City; however, truck traffic destined to and from the agricultural and industrial business along the railway must still come through town.

Of the companies surveyed, the lowest number of trucks were run through Abbot Transportation (a truck way station) with repairs to about one truck a day. Woodgrain Millwork of Fruitland, Idaho was the next lowest with 25 truckloads per week. The other businesses ranged from 30 to 90 truck runs a day. Much of the truck traffic in Ontario is cyclical, coinciding with the farming season.

Truck cargo originating in the city consists of mostly agricultural products, such as beets, onions, potatoes, cereal grains, and wood products.

### **3.11. PUBLIC TRANSPORTATION**

Malheur Transportation Service, a private non-profit organization, helps coordinate transportation providers within the county. It coordinates city bus, senior center van service, and volunteer services which provide rides for medical purposes and transportation for developmentally disabled

people commuting to a worksite. Malheur Transportation Service works to maximize the use of all vans and provides backup dispatch.

Greyhound Lines currently provides bus service for Ontario. Greyhound currently operates a summer schedule with three buses traveling daily between Ontario and Portland, one bus daily between Ontario and Seattle, and four buses daily between Ontario and Boise. During other seasons, Greyhound operates two buses daily in each direction on I-84. These runs provide westbound connections to Pendleton, Portland and Seattle, and eastbound connections to Boise.

In past years, Ontario has had service along US 26 to John Day, Mitchell, and other westerly destinations. Prior to 1990, Greyhound provided this service. For about six months during the early 1990s, Porter Stage Lines operated a similar service on US 26.

### **3.12. AIR TRANSPORTATION**

Ontario Municipal Airport, located in the southwest corner of the city, serves the community. No commercial flights are available at the airport at the present time. It is publicly owned and had 47 aircraft based (normally stored) at the facility in 1994. The airport is part of the National Plan of Integrated Airport Systems (NPIAS) with a general aviation service level. It has one 4,531 ft. paved runway, has an approach category of B (planes can fly in at between 91 and 120 knots), and an airplane design group of II (planes with a wingspan of 49 feet to 78 feet can use the facility). In 1994, the airport had 11,000 operations. (An operation refers to a landing or takeoff; both a landing and a takeoff would account for two operations.) The airport has some navigational aids (MIRL, REILs, and VASIs) for approach guidance.

The airport is classified as a Level 3 facility, meaning its primary role is to provide local support and access and second-tier economic development. The airport is useful for corporate flights, general aviation, and air taxi service.

City residents can access commercial air service at the Boise International Airport located approximately 60 miles southeast of the city in Boise, Idaho. This airport is roughly one hour away by car and has flights to larger destinations such as Portland and Salt Lake City.

### **3.13. WATER TRANSPORTATION**

Although the Snake River is adjacent to Ontario, there is no port or marine freight terminal in the area. Barge traffic begins further down stream between Lewiston, Idaho, and Portland, Oregon. In the Ontario area the Snake River is used primarily for recreational purposes.

### **3.14. PIPELINE FACILITIES**

Although not often considered as transportation facilities, pipelines carry liquids and gases very efficiently. The use of pipelines can greatly reduce the number of trucks and rail cars carrying fluids such as natural gas, oil, and gasoline.

Williams Pipeline Company and Chevron Pipeline Company have pipelines crossing the Snake River and OR 201 at the northeast corner outside of the city limits. Williams Pipeline Company provides natural gas to local companies that transport natural gas into the city at various meter stations. Chevron Pipeline Company transports gasoline and other petrofuels through pipelines and does not service the City of Ontario directly.

**SECTION 4.0**  
**EXISTING CONDITIONS AND DEFICIENCIES**

## **Section 4.0**

### **Existing Conditions and Deficiencies**

#### **4.1. INTRODUCTION**

This section of the Ontario Transportation System Plan describes existing transportation conditions and associated deficiencies in the urban growth boundary (UGB) of the city. These conditions and deficiencies will be used as a foundation for identifying short-term transportation improvement needs and developing and evaluating longer-term transportation system alternatives unless superseded by specific studies. Specific studies do exist as of the date of this publication, February, 2005, for certain areas, and shall be used where applicable instead of the data in this section. These studies include the East Idaho Traffic Study; the East Ontario Commercial Area Traffic Study; the Oregon 201 Corridor Refinement Plan; and, the North Ontario Interchange Area Management Plan.

#### **4.2. INTERSECTION LEVELS OF SERVICE AND V/C RATIO ANALYSIS**

Intersection capacity was measured by the following two methodologies: level of service (LOS) and volume to capacity (v/c) ratio. Level of service to measure the performance at an intersection is the standard practice in the transportation planning and traffic engineering profession. This concept was developed by the Transportation Research Board (TRB). The *2000 Highway Capacity Manual*<sup>1</sup> documents the level of service analysis methodology. The Highway Capacity Manual measures level of service on a scale of LOS A to LOS F. LOS A means that drivers experience no delay or relatively low amounts of delay while traveling through an intersection; while LOS F means that drivers experience a great deal of delay while traveling through an intersection. Typically, most jurisdictions set their level of service standard at LOS D since LOS E denotes that the intersection capacity is being met and LOS F means that conditions beyond the existing intersection capacity are occurring. When LOS F conditions occur, they indicate that it would take motorists multiple signal cycles or a great deal of delay to travel through an intersection. In Section 2, Transportation Goals and Policies, the level of service standard for Ontario has been set at LOS D for signalized intersections and LOS E for unsignalized intersections if the intersection does not meet traffic signal warrants.

The Oregon Department of Transportation bases its traffic operation standards based on volume to capacity (v/c) ratio and not level of service. For ODOT facilities, each type of facility has its own standard. Table 4-1 summarizes the v/c standard by ODOT facility type. The standard documented in Table 4-1 is from the *1999 Oregon Highway Plan*.<sup>2</sup>

The v/c ratio is a measure of the percentage of used capacity on the roadway. A value of 0.00 indicates no traffic on the roadway, and a value of 1.00 indicates that the entire capacity of the

---

<sup>1</sup> *2000 Highway Capacity Manual*; Transportation Research Board, National Research Council; Washington, D.C. 2000.

<sup>2</sup> *1999 Oregon Highway Plan*, Oregon Department of Transportation – Transportation Development Division, Planning Section, March 1999.

roadway is being utilized. The *1999 Oregon Highway Plan* indicates that for interstate highways and statewide, freight route highways on the NHS system, the maximum acceptable v/c is 0.70. Statewide, non-freight route highways and regional highways, the maximum acceptable v/c ratio is 0.80 for areas within the UGB and posted speed limits less than 45 mph. This changes to a maximum v/c ratio of 0.80 for speed limits equal or greater than 45 mph.

**Table 4-1  
Maximum Volume-to-Capacity Ratios for Peak Hour Operating Conditions Through a  
Planning Horizon for State Highway Sections Located Outside the Portland Metropolitan  
Area Urban Growth Boundary**

Highway	Land Use Type/Speed Limits					
	Inside Urban Growth Boundary				Outside Urban Growth Boundary	
	STAs	MPO	Non-MPO outside of STAs where non-freeway speed limit <45 mph	Non-MPO where non-freeway speed limit >=45 mph	Unincorporated Communities	Rural Lands
Interstate Highways and Statewide (NHS) Expressways	N/A	0.80	0.70	0.70	0.70	0.70
Statewide (NHS) Freight Routes	0.85	0.80	0.75	0.70	0.70	0.70
Statewide (NHS) Non-Freight Routes and Regional or District Expressways	0.90	0.85	0.80	0.75	0.75	0.70
Regional Highways	0.95	0.85	0.80	0.75	0.75	0.70
District/Local Interest Roads	0.95	0.90	0.85	0.80	0.80	0.75

*Source: 1999 Oregon Highway Plan (OHP)*

Interstates and Expressways shall not be identified as Special Transportation Areas (STAs)

For the purpose of this mobility policy of volume-to-capacity ratio standards, the peak hour shall be the 30<sup>th</sup> highest annual hour. This approximates weekday peak hour traffic in larger urban areas.

For district highways and local interest roadways, the maximum acceptable v/c ratio is 0.80 for areas inside the UGB with speed limits less than 45 mph is 0.85. This changes to a maximum v/c ratio of 0.80 for speed limits equal or greater than 45 mph.

For unsignalized intersections, the *1999 OHP* sets the following standard:

At unsignalized intersections and road approaches, the volume-to-capacity ratios in Table 4-1 shall not be exceeded for either of the state highway approaches that are not stopped. Approaches at which traffic must stop, or otherwise yield the right-of-way, shall be operated to maintain safe operation of the intersection and all of its approaches and shall



not exceed the volume-to-capacity ratios for District/Local Interest Roads standard inside urban growth boundaries.<sup>3</sup>

For signalized intersections, the *1999 OHP* sets the following standard:

At signalized intersections other than crossroads of freeway ramps, the total volume-to-capacity ratio for the intersection considering all critical movements shall not exceed the volume-to-capacity ratios in Table 4-1. Where two state highways of different classifications intersect, the lower of the volume-to-capacity ratios in the table shall apply. Where a state highway intersects with a local road or street, the volume to capacity ratio for the state highway shall apply.<sup>4</sup>

The interchange ramp v/c standard within the *1999 OHP* states:

...The primary cause of traffic queuing at freeway off-ramps is inadequate capacity at the intersections of the freeway ramps with the crossroad. These intersections are referred to as ramp terminals. In many instances where ramp terminals connect with another state highway, the volume to capacity standard for the connecting highway will generally be adequate to avoid traffic backups onto the freeway. However, in some instances where the crossroad is another state highway or a local road, the standards will not be sufficient to avoid this problem. Therefore, the maximum volume to capacity ratio for the ramp terminals of interchange ramps shall be the smaller of the values of the volume to capacity ratio for the crossroad, or 0.85.<sup>5</sup>

The 1999 OHP specifies that the v/c ratio mobility standards shall be used for the following:

- Identifying state highway mobility performance expectations for planning and plan implementation.
- Evaluating the impacts on state highways of amendments to transportation plans, acknowledged comprehensive plans and land use regulations pursuant to the Transportation Planning Rule (OAR 660-12-060); and
- Guiding operations decisions such as managing access and traffic control systems to maintain acceptable highway performance.

---

<sup>3</sup> *1999 Oregon Highway Plan*, Oregon Department of Transportation – Transportation Development Division, Planning Section, March 1999, page 68.

<sup>4</sup> *1999 Oregon Highway Plan*, Oregon Department of Transportation – Transportation Development Division, Planning Section, March 1999, page 68.

<sup>5</sup> *1999 Oregon Highway Plan*, Oregon Department of Transportation – Transportation Development Division, Planning Section, March 1999, page 68.

The levels of service and v/c analysis performed for this study were based on the 30<sup>th</sup> highest hour design volumes. This is equivalent to the weekday P.M. peak hour in August. August is typically the peak traffic month and the 30<sup>th</sup> highest hour design volume occurs in this month. The weekday A.M. peak hour was also analyzed based on seasonal adjustments to August. The analysis revealed that traffic operations at the study area intersections in the Ontario UGB are all acceptable. Table 4-2 summarizes the level of service at the study area intersections.

**Table 4-2. Existing Levels of Service**

	LOS	Average Delay (sec)	Volume to Capacity Ratio	Maximum Allowable Standard
4th Avenue/Verde Drive	B	16.1	0.45	0.85
West Idaho Avenue/SW 2nd Street	B	12.9	0.36	0.85
West Idaho Avenue/Oregon Street	C	24.9	0.54	0.85
East Idaho Avenue/East 2nd Street	B	15.6	0.60	0.85
East Idaho Avenue/East Lane	B	19.7	0.66	0.85
SW 4th Avenue/Dorian Drive	A	6.8	0.26	0.85
SW 4th Avenue/SW 9th Street	B	14.3	0.38	0.85
SW 4th Avenue/SW 4th Street	B	15.9	0.40	0.85
SW 4th Avenue/SW 2nd Street	D	46.3	0.34	0.85
<b>Unsignalized Intersection</b>				
I-84 NB Ramps/Highway 201				
Eastbound Left	A	1.2	0.03	0.85
Northbound Approach	C	20.5	0.48	0.85
I-84 SB Ramps/Highway 201				
Westbound Left	A	2.1	0.07	0.85
Southbound Approach	B	11.4	0.12	0.85
Oregon Street/Washington Avenue				
Eastbound Approach	C	24.9	0.68	0.85
Northbound Left	A	8.2	0.05	0.85
West Idaho Avenue/Verde Drive				
Eastbound Approach	A	10.0	0.20	LOS E
Westbound Approach	B	11.7	0.40	LOS E
Northbound Approach	B	11.2	0.34	LOS E
Southbound Approach	B	11.3	0.35	LOS E
West Idaho Avenue/SW 9th Street				
Eastbound Approach	B	10.9	0.29	LOS E
Westbound Approach	B	14.9	0.55	LOS E
Northbound Approach	B	11.8	0.38	LOS E
Southbound Approach	B	10.6	0.22	LOS E
West Idaho Avenue/SW 4th Street				
Eastbound Left	A	0.1	0.01	LOS E
Westbound Left	A	4.0	0.14	LOS E
Northbound Approach	C	20.3	0.43	LOS E
Southbound Approach	D	27.8	0.19	LOS E
SW 5th Avenue/SW 4th Street				
Eastbound Left	A	2.8	0.12	LOS E
Westbound Left	A	0.1	0.01	LOS E
Northbound Approach	E	44.7	0.26	LOS E
Southbound Approach	C	17.3	0.46	LOS E

Table 4-2 compares the existing levels of service and v/c ratio with the maximum allowable performance standard. As shown in Table 4-2, all of the study area intersections currently operate within the maximum allowable level of service and v/c ratio standards.

### 4.3. HIGH CRASH LOCATIONS

Crash data was obtained from the Oregon Department of Transportation for the period between January 1, 2001 and December 31, 2003. The crash data summarized are only reported crashes and there may be other crashes that occurred that were not reported. The data available includes total crashes, crashes by severity (i.e. fatal, injury or property damage only), and crash collision type. Since there were 534 intersection locations that reported one or more crash per year, only the intersections with two or more crashes per year were summarized in the TSP. The entire crash data summary is included in Appendix C. The intersection crash data is summarized in Table 4-3. The table only contain crashes by severity type and crashes per year. Crash rates (crashes per million vehicle miles traveled and crashes per million entering vehicles) were not calculated due to the unavailability of traffic counts at all of the intersections. Since the crash data is given as an average, the data is shown in fractions of a crash to the nearest tenths. It should be noted that the crash information only showed intersection crashes. Either all of the crashes were reported at the nearest intersection or there were no mid-block crashes.

A measure of five crashes per year was also used in evaluating intersection locations for high crashes. The five crashes per year secondary threshold was used because it is the threshold for one of the traffic signal warrants. If an unsignalized intersection has five or more crashes per year, the Manual on Uniform Traffic Control Devices (MUTCD),<sup>6</sup> allows the intersection for consideration of signalization.

**Table 4-3. Intersection Crash Summary**

Intersection	Severity				Average Crashes Per Year
	PDO	Injury	Fatal	Total	
Idaho Ave/NE 2nd St	3	3	0	6	2
Idaho Ave/SE 3rd St	5	1	0	6	2
SW 4th Ave/SW 1st St	5	1	0	6	2
SW 5th Ave/SW 4th St	6	0	0	6	2
Dorian Dr/SW 4th Ave	5	2	0	7	2.3
Idaho Ave/NW 1st St	4	3	0	7	2.3
SW 4th Ave/SW 9th St	2	5	0	7	2.3
SW 7th St/SW 4th Ave	3	4	0	7	2.3
Alameda Dr/SW 4th Ave	4	4	0	8	2.7
Idaho Ave/NE 4th St	5	3	0	8	2.7

<sup>6</sup> Manual on Uniform Traffic Control Devices (MUTCD), U.S. Department of Transportation, Federal Highway Administration, 2003 Edition, page 4C-8

**Table 4-3. Intersection Crash Summary Continued**

Intersection	Severity				Average Crashes Per Year
	PDO	Injury	Fatal	Total	
Idaho Ave/Goodfellow St	7	2	0	9	3
Idaho Ave/SE 4th St	4	6	0	10	3.3
Park Blvd/SW 4th Ave	6	4	0	10	3.3
SW 4th Ave/SW 12th St	2	8	0	10	3.3
SW 4th Ave/SW 5th St	7	4	0	11	3.7
Oregon St/Idaho Ave	5	9	0	14	4.7
SW 4th Ave/Verde Dr	10	5	0	15	5
SW 4th Ave/SW 4th St	10	16	0	26	8.7
Idaho Ave/East Lane	18	18	0	36	12

As shown in Table 4-3, the following intersections have an average of five or more crashes occurring per year:

- SW 4<sup>th</sup> Avenue/Verde Drive – 5.0 crashes per year
- SW 4<sup>th</sup> Avenue/SW 4<sup>th</sup> Street – 8.7 crashes per year
- Idaho Avenue/East Lane – 12.0 crashes per year

#### **4.4. EXISTING INTERSECTION CAPACITY IMPROVEMENT NEEDS**

All of the major study intersections along ODOT highways operate within the maximum v/c ratio standard. All of the study area intersections along city roadways operate at LOS D or better for signalized intersections and LOS E or better for unsignalized intersections.

#### **4.5. SAFETY IMPROVEMENT NEEDS**

The following locations should be evaluated to see whether any safety measures can be implemented to reduce the crash rate:

- SW 4<sup>th</sup> Avenue/Verde Drive – 5.0 crashes per year
- SW 4<sup>th</sup> Avenue/SW 4<sup>th</sup> Street – 8.7 crashes per year
- Idaho Avenue/East Lane – 12.0 crashes per year

#### **4.6. BRIDGES**

Based on Section 3, Existing Inventory, the following bridge location was identified as functionally obsolete with a sufficiency rating less than 55:

- SE 5<sup>th</sup> Avenue over I-84 – Bridge Nimbus Number 08400

#### **4.7. PEDESTRIAN AND BICYCLE FACILITIES**

Only approximately 39 percent of Ontario's roadways have sidewalks. In many cases these sidewalks are not continuous and may not lead to anywhere or link between uses. For example, the neighborhoods are not well linked to schools and the commercial areas. The future pedestrian plan will identify improvements that better link uses together.

The major limitation to bicycle travel in the City of Ontario is the same as one of the most significant problems for motorists: the lack of connecting streets for through travel. Another impediment to bicycle use is the lack of parking and storage facilities for bikes throughout the City of Ontario area. The future bicycle facilities plan will identify improvements to develop a more functional system to promote bicycle travel. As for bicycle parking, it is addressed in the implementing ordinances and code changes.

**SECTION 5.0**  
**2025 TRAVEL DEMAND FORECAST AND**  
**FUTURE DEFICIENCIES**

## **Section 5.0**

### **2025 Travel Demand Forecast and Future Deficiencies**

#### **5.1. TRAVEL DEMAND FORECAST METHODOLOGY**

Based on ODOT's 2001 Transportation System Planning Guidelines<sup>1</sup>, there are four approved methodologies to forecast future traffic volumes. These methodologies are described below:

- **Level 1 – Trending Forecast**  
The trending forecast is based on historical traffic counts in the study area. The methodology requires existing traffic counts as well as 20-year old historical traffic counts to establish a growth rate. This methodology is typically employed in areas where traffic patterns are simple and that have low to moderate growth. It is the simplest methodology used to project future traffic volumes.
  
- **Level 2 – Cumulative Analysis**  
The cumulative analysis uses historical trending information as well as an examination of future development. This analysis requires a good understanding of development trends in the study area. Based on the understanding of future development, each area of projected development is assigned a trip making characteristic and those trips are manually assigned to the street network. The cumulative analysis methodology is typically used small cities where traffic patterns are not complex. This methodology is also best employed where significant shifting of traffic is not expected between alternatives since the difference in how the traffic patterns would change is to be done manually.
  
- **Level 3 – Transportation Model**  
A transportation model is a very sophisticated methodology in forecasting future traffic volumes. It requires a significant amount of traffic and land use data as well as specialized software. Transportation models are typically developed where there is a need to study complex alternatives that can affect traffic patterns significantly. Transportation models are good to compare alternatives to each other since they effectively show the difference in travel behavior between alternatives. This travel demand forecast methodology is beyond the scope of this study process.
  
- **Level 4 – Regional Transportation Model**  
A regional transportation model is developed in a similar manner as the Level 3, Transportation Model except that it involves a larger study area. The study area in a regional model encompasses several urban areas as well as rural areas. It is typically employed at the Metropolitan Planning Organization (MPO) level. This travel demand forecast methodology is beyond the scope of this study process.

---

<sup>1</sup> 2001 Transportation System Planning Guidelines, Oregon Department of Transportation, Transportation Development Division, May 2001.

## **5.2. TRAVEL DEMAND FORECAST EMPLOYED FOR CITY OF ONTARIO**

In the previous Draft Ontario Transportation System Plan, a Level 3 traffic forecast methodology was utilized using a software called QRS II. At the beginning of this current TSP update process, it was explored whether it was still possible to use the old QRS II model. Based on research, these model files were not available from either ODOT or the consultant that developed the model. The only available information regarding the model is what is already contained in the previous Draft Ontario TSP.

Due to schedule and budget constraints, it was not feasible to reconstruct a Level 3 traffic model for the current TSP update effort. Therefore, the 2025 traffic volumes were forecasted based on utilizing the old QRS II model results to develop growth factors between the existing and future conditions. These growth factors were then applied to the 30<sup>th</sup> highest design hour existing traffic volumes previously developed to yield a 30<sup>th</sup> highest hour, 2025 traffic projection.

## **5.3. 2025 TRAFFIC VOLUME PROJECTIONS**

### **5.3.1. Traffic Volumes**

The 2025 future traffic volumes were developed by first identifying the traffic growth pattern identified by the old QRS II model between the existing and future alternatives. These growth patterns were then applied to new traffic counts (adjusted to account for peak seasonal traffic) taken in 2004 to develop the 2025 traffic volumes.

Traffic forecasts were developed for the 2025 No Build Alternative which assigns future traffic to the unchanged street network. This scenario will determine which portions of the transportation system would be deficient within the next 20 years based upon the anticipated growth in the Ontario area.

Figure 5-1a and 5-1b show the locations of the study area intersections. The 2025 traffic volumes for the No Build Alternative are shown in Figure 5-2.

### **5.3.2. 2025 Level of Service and V/C Ratio Analysis**

Based on the 2025 traffic volumes, levels of service and volume-to-capacity (v/c) ratios were calculated for the study area intersections. The levels of service and v/c ratio analyses are summarized in Table 5-1.

It should be noted that the 2025 level of service and v/c ratio analysis are based on generalized long range traffic projections. These traffic projections use long-range household and employment projections as a major input to develop the 2025 traffic projections. Because this methodology is substantially different than other types of traffic projections associated with development projects, the results will differ and will not necessarily be comparable.



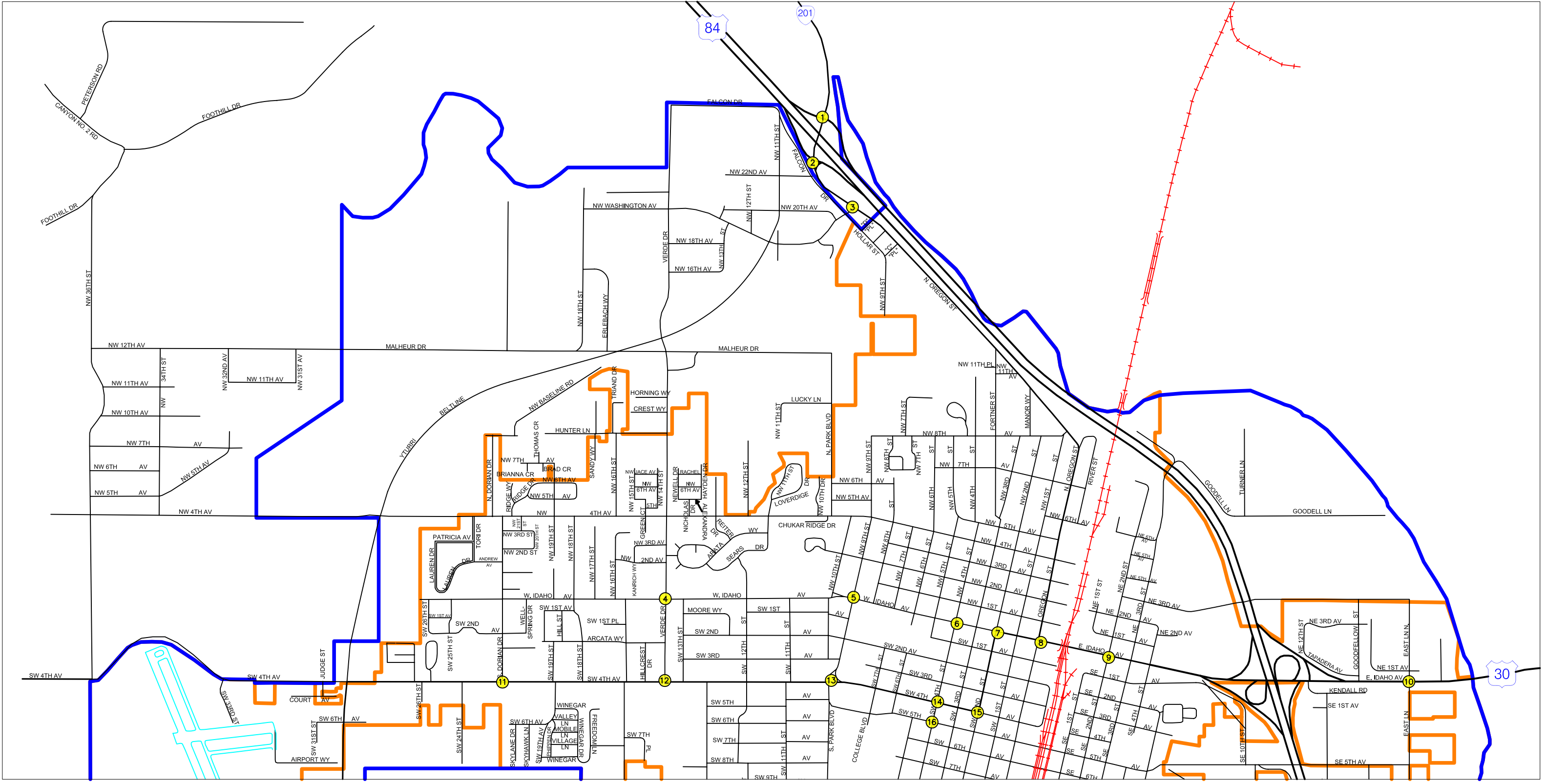

# City of Ontario Transportation System Plan

**LEGEND**  
Study Area Intersection ①

**Figure 5-1a**  
Location of Study Area Intersections

NOT TO SCALE

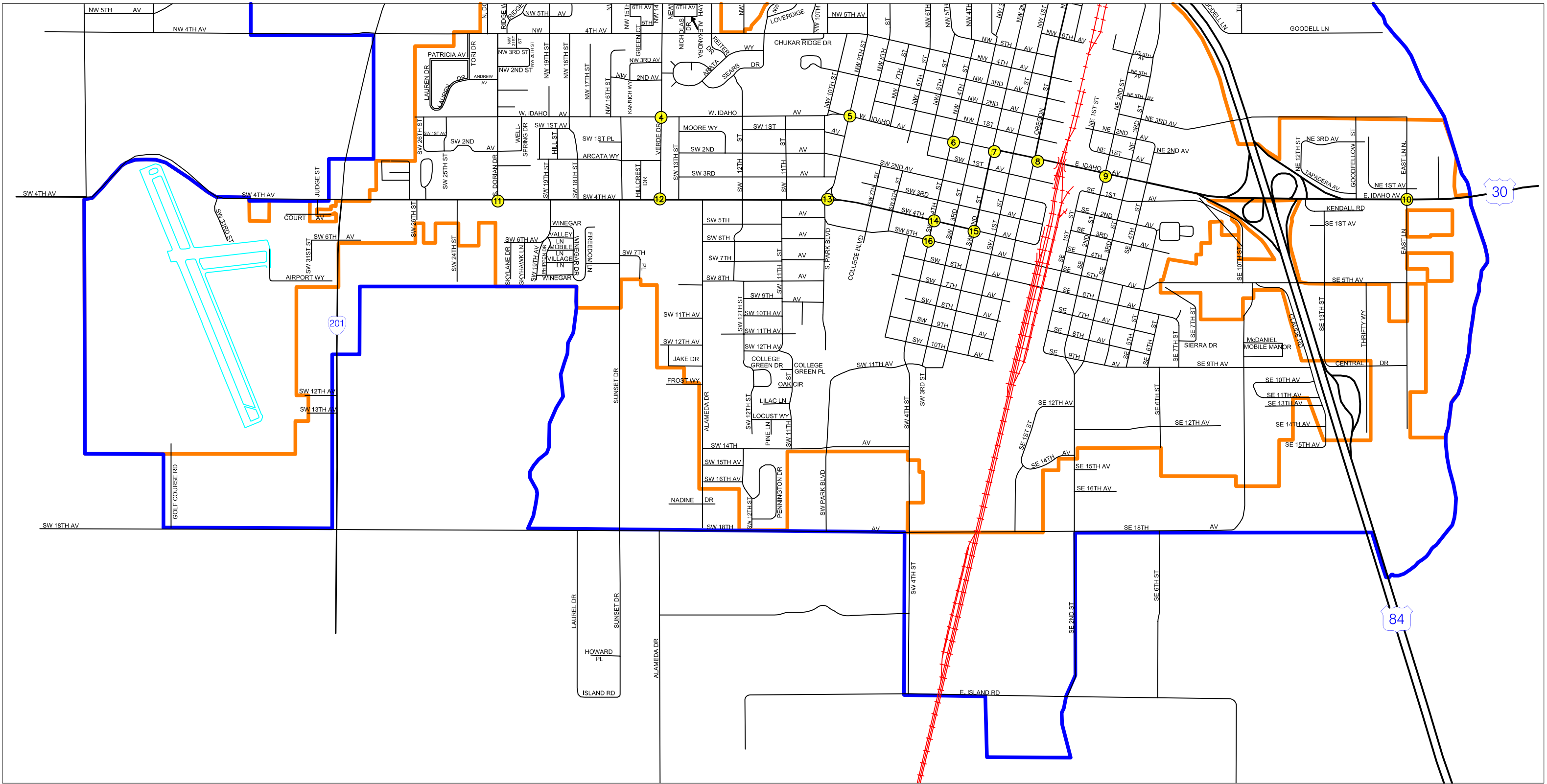

# City of Ontario Transportation System Plan

## LEGEND

Study Area Intersection (1)



NOT TO SCALE

**Figure 5-1b**

Location of Study Area Intersections

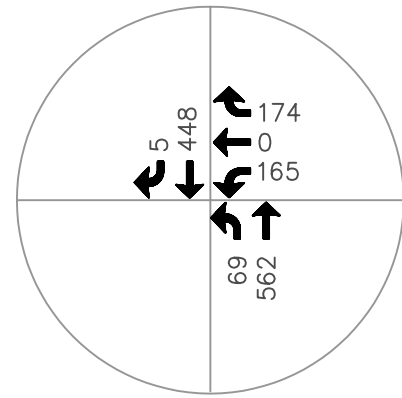

Intersection 1  
OR 201/I-84 WB Ramps

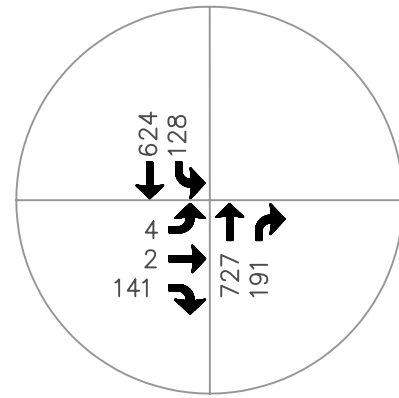

Intersection 2  
OR 201/I-84 EB Ramps

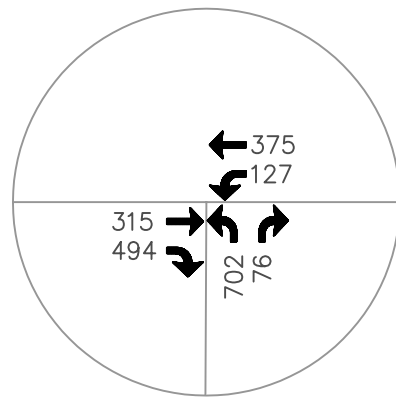

Intersection 3  
Oregon St/Washington Av

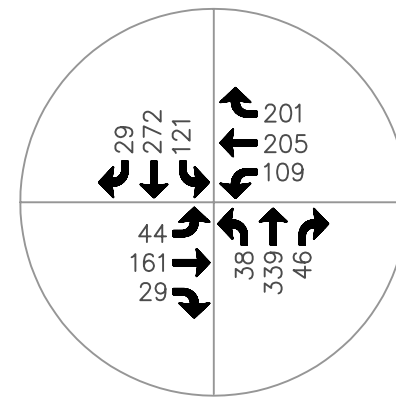

Intersection 4  
West Idaho Av/Verde Dr

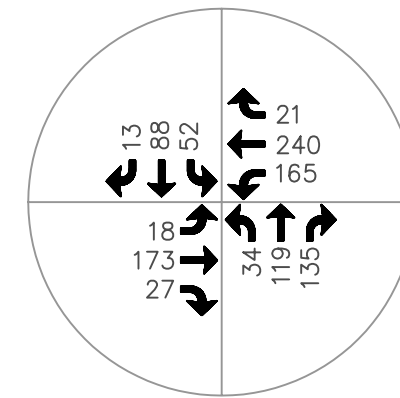

Intersection 5  
West Idaho Av/SW 9th St

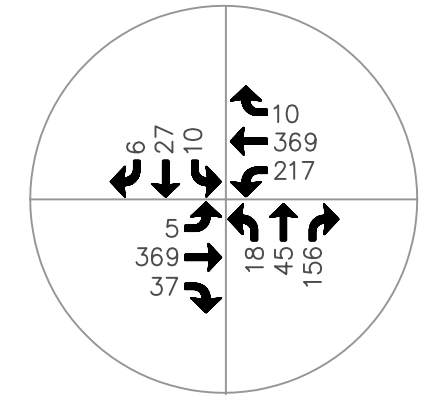

Intersection 6  
West Idaho Av/SW 4th St

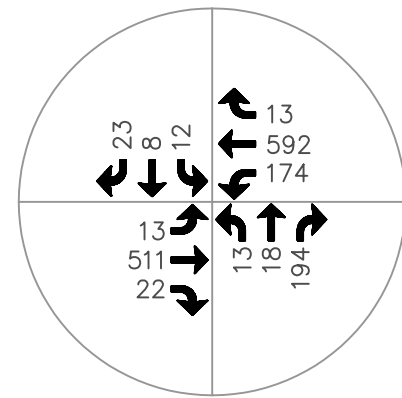

Intersection 7  
West Idaho Av/SW 2nd St

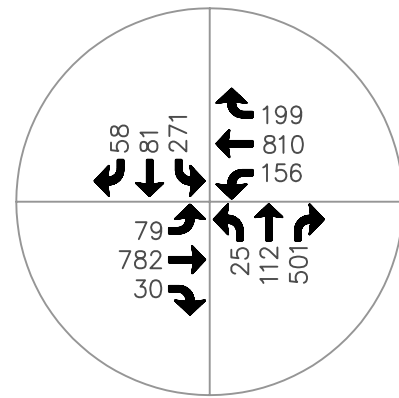

Intersection 8  
West Idaho Av/Oregon St

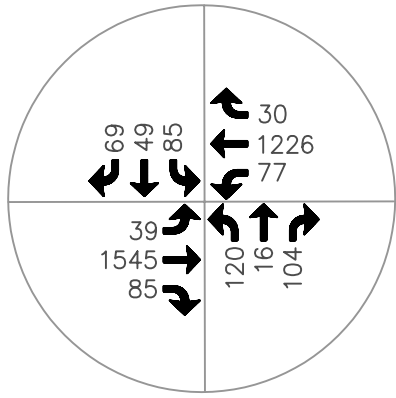

Intersection 9  
East Idaho Av/SW 2nd St

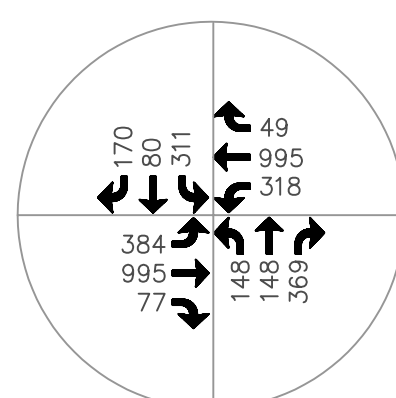

Intersection 10  
East Idaho Av/East Lane

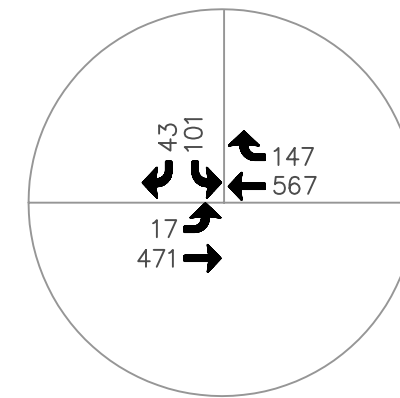

Intersection 11  
SW 4th Av/S. Dorian Dr

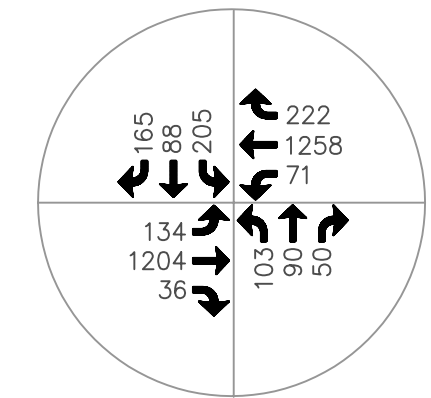

Intersection 12  
SW 4th Av/Verde Dr

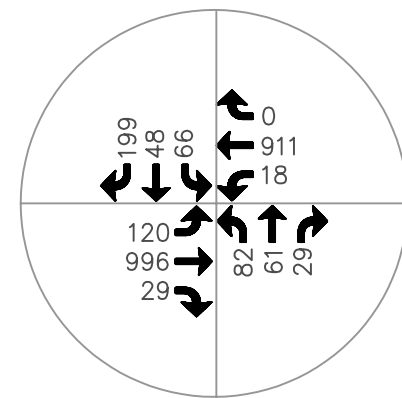

Intersection 13  
SW 4th Av/SW 9th St

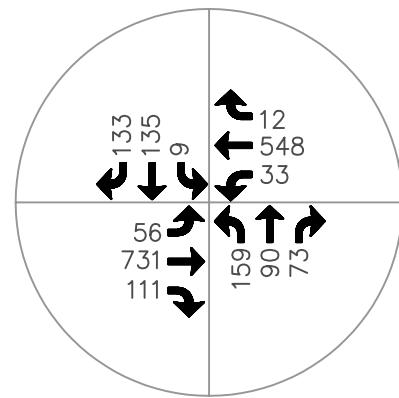

Intersection 14  
SW 4th Av/SW 4th St

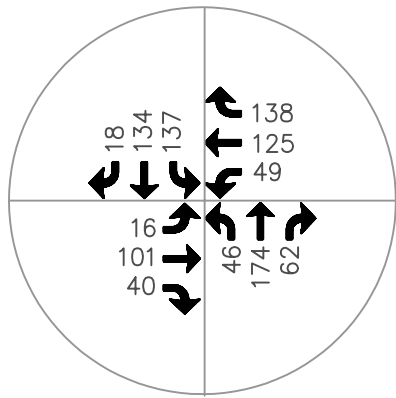

Intersection 15  
SW 4th Av/SW 2nd St

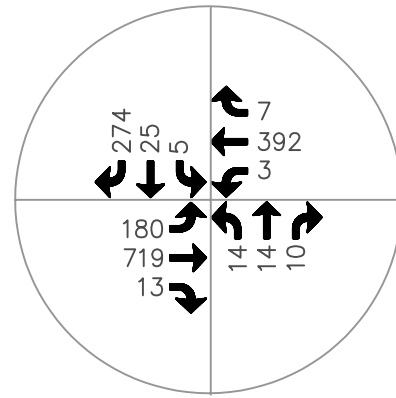

Intersection 16  
SW 5th Av/SW 4th St

# City of Ontario Transportation System Plan



NOT TO SCALE

## LEGEND

PM Peak Hour  
Traffic Volume

550

**Figure 5-2**  
2025 No Build P.M.  
Peak Hour Traffic Volumes

**Table 5-1. Year 2025 Levels of Service – No Build Alternative**

Signalized Intersection	P.M. Peak Hour			
	LOS	Average Delay (sec)	Volume to Capacity Ratio	Maximum Allowable Standard
<b>4th Avenue/Verde Drive</b>	D	41.1	<b>1.03</b>	0.85
West Idaho Avenue/SW 2nd Street	B	13.0	0.46	0.85
West Idaho Avenue/Oregon Street	C	31.9	0.72	0.85
East Idaho Avenue/East 2nd Street	B	17.9	0.76	0.85
<b>East Idaho Avenue/East Lane</b>	C	34.6	<b>0.97</b>	0.85
SW 4th Avenue/Dorian Drive	A	7.6	0.34	0.85
SW 4th Avenue/SW 9th Street	B	16.7	0.50	0.85
SW 4th Avenue/SW 4th Street	B	18.4	0.53	0.85
SW 4th Avenue/SW 2nd Street	D	47.3	0.45	0.85
Unsignalized Intersection				
<b>I-84 NB Ramps/Highway 201</b>				
Eastbound Left	A	1.8	0.07	0.85
<b>Northbound Approach</b>	F	>100	<b>&gt;1.5</b>	0.85
I-84 SB Ramps/Highway 201				
Westbound Left	A	5.7	0.22	0.85
Southbound Approach	D	28.4	0.52	0.85
<b>Oregon Street/Washington Avenue</b>				
<b>Eastbound Approach</b>	F	>100	<b>&gt;1.5</b>	0.85
Northbound Left	B	11.0	0.19	0.85
<b>West Idaho Avenue/Verde Drive</b>				
Eastbound Approach	D	32.2	0.70	LOS E
<b>Westbound Approach</b>	F	>100	1.40	LOS E
<b>Northbound Approach</b>	F	>100	1.17	LOS E
<b>Southbound Approach</b>	F	>100	1.17	LOS E
West Idaho Avenue/SW 9th Street				
Eastbound Approach	B	15.9	0.45	LOS E
Westbound Approach	D	32.1	0.83	LOS E
Northbound Approach	C	17.9	0.58	LOS E
Southbound Approach	B	13.8	0.34	LOS E
<b>West Idaho Avenue/SW 4th Street</b>				
Eastbound Left	A	0.1	0.01	LOS E
Westbound Left	A	4.8	0.20	LOS E
<b>Northbound Approach</b>	F	54.2	0.80	LOS E
<b>Southbound Approach</b>	F	64.4	0.44	LOS E
<b>SW 5th Avenue/SW 4th Street</b>				
Eastbound Left	A	3.8	0.16	LOS E
Westbound Left	A	0.1	0.01	LOS E
<b>Northbound Approach</b>	F	>100	0.81	LOS E
Southbound Approach	E	40.8	0.79	LOS E

#### **5.4. FUTURE INTERSECTION AND ROADWAY CAPACITY DEFICIENCIES**

Of all of the signalized ODOT study area intersections, the following two intersections are projected to exceed the maximum v/c standard of 0.85:

- 4<sup>th</sup> Avenue/Verde Drive
- East Idaho Avenue/East Lane

The following two ODOT unsignalized intersections are projected to exceed the maximum v/c standard of 0.85 in the 2025 No Build condition:

- I-84 NB Ramps/Highway 201
- Oregon Street/Washington Avenue

The following three Ontario unsignalized intersections are projected to exceed the maximum level of service standard of LOS E:

- West Idaho Avenue/Verde Drive
- West Idaho Avenue/SW 4th Street
- SW 5th Avenue/SW 4th Street

Seven of the 16 study area intersections are projected to operate in excess of the maximum adopted transportation performance standards. Improvements will be proposed later in the TSP that mitigate the traffic operations at these intersections to meet the adopted transportation performance standards.

**SECTION 6.0**  
**TRANSPORTATION SYSTEM**  
**ALTERNATIVES ANALYSIS**

## **Section 6.0**

### **Transportation System Alternatives Analysis**

#### **6.1. ODOT STIP PROJECTS**

Oregon's Final 2004-2007 Statewide Transportation Improvement Program (STIP) is the state's transportation preservation and capital improvement program. It covers a four-year period from 2004 to 2007. The STIP includes projects of regional significance and even includes projects in the National Parks, National Forests, and Indian Reservations. Funding sources are from a variety of sources including but not limited to federal, state, and local government transportation funds. It should be noted that the STIP is a project scheduling and funding document. Projects are scheduled and funded based on priorities developed.

The following STIP project types exist:

- Pavement Preservation Program
- Bridge Preservation Program
- Modernization Program
- Safety Program
- Operations Program
- Congestion Mitigation and Air Quality Improvement
- Transportation Enhancement Program
- Public Transportation Programs
- Statewide (Bucketed) Programs including those projects characterized by Special Programs projects

In addition to the project types listed above, STIP projects are also funded by a special program enacted by the 2001, 2002, and 2003 Oregon Transportation Investment Act (OTIA). In 2001 and 2002, the passing of OTIA allowed the Oregon Department of Transportation to sell bonds which brought \$500 million into the State Highway Fund. The following year, 2003, OTIA III was passed by the Oregon State Legislature. OTIA III allowed ODOT to sell bonds to bring an additional \$2.5 billion into the State Highway Fund. The money generated by OTIA has been dedicated to modernization, bridge, and pavement preservation projects.

Based on a review of the 2004-2007 STIP, the following type of STIP projects are currently programmed within the City of Ontario UGB:

- Pavement Preservation
- Operations Program
- Bridge Preservation Program
- Jurisdictional Exchange
- Statewide (Bucketed) Programs including those projects characterized by Special Programs projects
- Modernization

### ***6.1.1. Pavement Preservation Projects***

The purpose of ODOT's pavement preservation project is to keep highways in the best condition at the lowest lifecycle cost. This purpose focuses on taking preventative measures to add useful life to a road before the pavement reaches poor condition. By implementing a preventative pavement preservation program rather than allowing poor pavement condition before any improvements, 75 to 80 percent savings can be achieved. One pavement preservation project is identified in the 2004-2007 STIP. These projects are described below:

- OR 201: Airport Corner – Cairo Junction Pavement Preservation – This project involves pavement preservation along OR 201 from Milepost 29.74 to Milepost 31.81. The total project cost is \$779,000. It is scheduled for construction in 2007.

### ***6.1.2. Bridge Preservation Projects***

Bridge replacement and rehabilitation is a critical component in the STIP to maintain an adequate transportation infrastructure. Although the life expectancy of a bridge is typically between 50 and 80 years, significant changes have occurred that require extensive bridge rehabilitation and/or replacement. These changes include significant increase in traffic volumes, especially truck traffic; heavier truck loads; longer truck loads which affect geometric standards as well as heavier truck weight loads; and higher speeds. All of these changes require upgrades to design standards. Many of the current bridges in operation were not built to current design standards that address the changes to truck freight movement.

A recent report that was made available to the Oregon House Interim Transportation Committee identified the funds needed to address the states bridge replacement and rehabilitation needs. This study identified approximately \$3.1 billion needed to address all of the state's bridge work. In comparison, the 2004-2007 STIP allocates \$342 million for bridges and OTIA III makes available \$1.3 billion. This is still far short of the need.

A bridge replacement and rehabilitation project is developed through the use of the Bridge Management System (BMS) and twelve deficiency parameters. Based on the BMS and deficiency parameters, no bridge projects are currently being funded in the City of Ontario.

### ***6.1.3. Special Programs***

There are no Special Programs projects funded in the City of Ontario in the 2004-2007 STIP.

### ***6.1.4. Operations Program***

An operations project improves the efficiency of the transportation system through the replacement of aging operational infrastructure and the deployment of projects and new technology to meet increased system demand. The Oregon Transportation Commission (OTC)



has approved approximately \$84 million for the funding of operations projects in the 2004-2007 STIP. The Operations Program includes the following four categories of projects: 1) slides and rockfalls; 2) intelligent transportation systems (ITS); 3) signs, signals, and illumination; and 4) transportation demand management. The following operations project is funded by the 2004-2007 STIP in Ontario:

- OR 201: Airport Corner – Cairo Junction – This project involves access management improvements from Milepost 29.74 to Milepost 31.81. The total project cost is \$1,964,000.

#### **6.1.5. Modernization**

Modernization projects are defined by capital construction projects which add capacity to the system, either through adding lanes, or building new facilities, such as bypasses. Oregon State law (ORS 366.507) requires that ODOT dedicate the equivalent of its share of 4¢ of State Highway Fund revenues (roughly \$51 to \$54 million per year) for highway modernization work.

Modernization projects have been a low priority in recent years because of the need to focus funding to the preservation of the state’s existing infrastructure. The Oregon Transportation Commission (OTC) has reduced the spending on modernization projects to the minimum level allowed by law. Consequently, only a few modernization projects have been considered over the last several years. The exception to this is the \$250 million that has been funded in 2002 through the Oregon Transportation Investment Acts, OTIA I and II. In addition, in 2003, an additional \$300 million was made available through OTIA III.

The criteria for selecting modernization projects for funding has been set by the OTC in April 2002. The text below from the 2004-2007 STIP gives the following guidance regarding the selection of modernization projects:

“Modernization projects are typically identified, selected and prioritized according to numerous factors and considerations including safety, potential land use impacts, modal integration, congestion, public support, environmental resources and impacts, cost relative to benefit, and economic impacts. All modernization projects, beginning in 2006, must meet the “Interim Criteria” approved by the OTC in April 2002.”

The following modernization projects are funded by the 2004-2007 STIP and the draft 2006-2009 STIP in Ontario:

- OR 201: North Ontario Interchange and Bridge Number 08635 – This project involves constructing a new overpass structure, ramps, and OR 201 alignment. The project limits are from Milepost 24.70 to Milepost 25.40. The total project cost is \$11,743,151. This project is scheduled for construction in 2006.

- Treasure Valley Biorefinery Access – This project involves reconstructing six local roads to provide biorefinery access. The project is scheduled to begin in 2008. The total project cost is \$4,020,000. Funding for this project will be from OTIA III.

### **6.1.6. Safety**

Section 4.0 of the TSP identified that the East Idaho Avenue/East Lane intersection has an average annual crash rate of 12.0 crashes per year. In recognition of this crash history, ODOT has funded the following project which was recently completed:

- OR 455; East Idaho Avenue Median Improvements – This project improved connectivity and circulation between East 4<sup>th</sup> Street and the I-84 ramps. The project boundaries were from Milepost 27.02 to Milepost 26.77.

## **6.2. OTHER IMPROVEMENTS**

Other improvements that were developed as part of the previous transportation system planning process are summarized in Table 6-1 and located in Figures 6-1a and 6-1b. These projects are primarily modernization projects to upgrade sub-standard arterials and collectors to current standards. It should be noted that the old numbering scheme from the previous TSP of the improvement projects is utilized for consistency. The most significant projects listed in Table 6-1 are briefly described below; some have been completed and specific plans developed as noted in Section 4.1 of this document. These include the East Idaho Traffic Study; the East Ontario Commercial Area Traffic Study; the Oregon 201 Corridor Refinement Plan; and, the North Ontario Interchange Area Management Plan.

**Project 101** - Project 101 is a key component of the Ontario Transportation Solution study that was undertaken during 1997-1998. It was designed to identify a comprehensive solution to several problems including high volumes of traffic in major transportation corridors; high volumes of traffic on the community's collector streets; high volumes of through truck traffic; and lack of good east-west connections across the railroad tracks.

The key components of Project 101 include construction of a new roadway with turn lanes at key intersections; a reconstruction of Airport Corner, including the installation of a traffic signal; and signals at other major intersections. The project details including the number of lanes used at key locations and the alignment is being finalized. This project may be completed in phases.

**Project 103** - Butler Boulevard is under the jurisdiction of Malheur County. Parts of it are within the Ontario urban growth boundary. Project 103 describes construction the road to a higher rural standard with wider pavement. This feature is especially important for truck traffic and the agricultural trucks destined for processors. Ultimately, an urban cross-section may be the appropriate standard for sections of Butler Boulevard.

**Project 104** - A new crossing over the railroad tracks in the Butler Boulevard corridor is another of the major elements of the Ontario Transportation Solution. The study conducted in 1997 and 1998 concluded that no single corridor could meet all the needs of the community. Project 104 and the new railroad overpass are especially important for agricultural truck traffic.

**Project 115** -The intersection of Oregon Street and Idaho Avenue is a key intersection in the City. It is among the most congested. Major improvements will be needed to increase capacity and to allow for turning movements by trucks. The planned improvement is likely to include channelization, increasing the turning radii, and widening W. Idaho Avenue to allow two westbound lanes beyond 4<sup>th</sup> Street and the installation of a traffic signal at W. Idaho Street and 4<sup>th</sup> Street.

**Project 118** - The Downtown Redevelopment project is likely to consist of a variety of improvements designed to implement a “Main Street” environment in the downtown area. It may include feature such as sidewalk extensions at intersections, wider sidewalks, raised crosswalks, street trees. Street furniture, pedestrian-scale street lighting, bike racks, and various traffic control devices to limit vehicle travel speeds. The improvements may be conducted in one or more phases. The planning for the project will need to address the specific features and specific location for each element. A combination of funding sources may be used including federal and state grants, city funds, and private funds.

**Project 119**– This project would involve constructing a new local street, SE 2<sup>nd</sup> Avenue to provide east west circulation between 13<sup>th</sup> Street and Goodfellow Street. The new roadway would replace Kendall Road.

**Project 201** - The North Ontario interchange does not meet current design standards. There are questions about the functional and structure adequacy of the interchange and there are no provisions for bicyclists and pedestrians. The project is needed during the short-range but has not yet been programmed in the State Transportation Improvement Program. Modifications to the interchange will meet the requirements of the *1999 Oregon Highway Plan*.

**Projects 314 - 318** - Five traffic signal projects are listed in anticipation of projected traffic that will lead to warrants being met at these locations. Traffic information, including traffic volumes, pedestrian volumes, and accident history, will need to be reviewed periodically to determine if signal warrants are met. Traffic signals are one method of reducing delay for entering vehicles and addressing various other transportation issues.

**Projects 401 - 405** – These are projects that will be driven by development. As these portions of the community develop through subdivisions or other mechanisms, the need for local and collector street systems will become apparent. Continuity of the street system and multiple options will help to spread traffic and reduce the reliance of the community’s major corridors. The identifications of local collector street systems serves as a guide to help develop multiple connections and avoid cul-de-sac streets. The precise locations and alignments of the local collector streets described in by these projects will need to be refined as developments are proposed.

**Table 6-1  
Transportation Project List Still Relevant from Previous TSP**

Proj No.	Project Location	Impv't. Category	Project Description	Project Improves		Project Justification							Project Phasing	Financial Partners			Project Distance (miles)	Unit Cost (per mile)	Project Cost							
				Travel by mode				Access	Economic	Safety	Operations	Truck Traffic		Urban Upgrade	Rural Upgrade	IDOT				County	Ontario					
				Vehicle	Bicycle	Pedestrian	Freight																			
103	SW 18th Av - Highway 201 to SW 4th Street	upgrade	Upgrade existing rural road to minor arterial standards; tapers provided per AASTO; provide for Pedestrians and bicyclists	■	■	■	■					✓	✓	✓					Short-range	◆	◆	◆	1.8	\$716,000	\$1,288,800	
105	N. Oregon Street - Yturri Beltline	rebuild	Build to minor arterial standards with curb, gutter and sidewalks	■	■	■	■					✓	✓	✓	✓					Short-range	◆	◆	◆	0.4	\$1,584,000	\$633,600
106	Verde Drive - 350 ft south of Hunter Lane to 20 feet north of Hunter Lane	upgrade	Upgrade to urban minor arterial standards; provide 3-lane cross-section or turn lanes at key intersections; provide for pedestrians and bicyclists; reduce sight distance restrictions	■	■	■	■					✓	✓	✓						Short-range	◆	◆	◆	0.5	\$1,552,000	\$776,000
108	NW Park Boulevard - Malheur Drive to NW 4th Avenue	upgrade	Upgrade to minor collector standards; provide turn lanes at key intersections; provide for pedestrians and bicyclists	■	■	■	■					✓	✓	✓						Short-range	◆	◆	◆	0.5	\$1,552,000	\$776,000
109	SE 2nd Street - SE 9th Avenue to SE 18th Av	upgrade	Upgrade to urban major collector standards; upgrade pavement to handle truck traffic; provide 2-lane cross-section with on-street parking; provide for pedestrians and bicyclists	■	■	■	■					✓	✓	✓						Short-range	◆	◆	◆	0.5	\$1,552,000	\$776,000
111	SE 5th Avenue - Bridge over I-84	upgrade	Widen existing bridge to minor arterial standards; improve safety; provide for pedestrians and bicyclists	■	■	■	■					✓	✓	✓						Short-range	◆	◆	◆	0.1	na	\$4,000,000
112	SE 5th Avenue - SE 5th Street to I-84 Bridge	upgrade	Upgrade to major collector standards; provide 3-lane cross-section or turn lanes at key intersections; provide for pedestrians and bicyclists	■	■	■	■					✓	✓	✓						Short-range	◆	◆	◆	0.4	\$1,552,000	\$620,800
113	SE 5th Avenue - I-84 Bridge to East Lane	upgrade	Upgrade to urban minor arterial standards; provide 3-lane cross-section or turn lanes at key intersections; provide for pedestrians and bicyclists	■	■	■	■					✓	✓	✓						Short-range	◆	◆	◆	0.3	\$1,910,000	\$573,000
115	Oregon Street/Idaho Avenue Intersection	intersection	Rebuild intersection, including channelization for right turns from northbound Oregon Street to eastbound Idaho Avenue; widen W Idaho to extend two west-bound thru lanes beyond 5th St; install signal at 4th St.	■	■	■	■					✓	✓	✓						Short-range	◆	◆	◆			\$1,500,000
118	Downtown Redevelopment Project	planning	A variety of pedestrian, bicycle, and traffic improvements to enhance the viability of the of the entire downtown area through traffic management and urban design	■	■	■	■					✓	✓	✓						Short-range	◆	◆	◆	na	na	\$500,000
203	Dorian Drive - SW 4th Avenue to NW 4th Avenue	upgrade	Upgrade to minor collector standards; provide for pedestrians and bicyclists	■	■	■	■					✓	✓	✓						Medium-range	◆	◆	◆	0.5	\$1,552,000	\$776,000
204	SW Alameda Drive - SE 18th Av to SW Frost Way	upgrade	Upgrade to urban minor collector standards; provide for pedestrians and bicyclists	■	■	■	■					✓	✓	✓						Medium-range	◆	◆	◆	0.4	\$1,552,000	\$620,800
205	SW Sunset Drive - SE 18th Av to SW 7th Place	upgrade	Upgrade to minor collector standards; provide for pedestrians and bicyclists	■	■	■	■					✓	✓	✓						Medium-range	◆	◆	◆	0.8	\$1,300,000	\$1,040,000
206	Malheur Drive - Reiter Drive to Park Boulevard	upgrade/ new	Construct new street or upgrade to minor collector standards; provide for pedestrians and bicyclists; connect with extension of Reiter Drive	■	■	■	■					✓	✓	✓						Medium-range	◆	◆	◆	0.3	\$1,552,000	\$465,600
208	SW Park Boulevard - SW 18th Av to SW 11th Avenue	upgrade	Upgrade to urban minor collector standards; provide for pedestrians and bicyclists	■	■	■	■					✓	✓	✓						Medium-range	◆	◆	◆	0.5	\$1,313,000	\$656,500
301	NW Washington Avenue - Verde Dr to Yturri Beltline	upgrade	Upgrade to urban major collector standards; provide for pedestrians and bicyclists; provide turn lanes at Yturri Beltline	■	■	■	■					✓	✓	✓						Medium-range	◆	◆	◆	0.3	\$2,112,000	\$633,600
302	SE 5th Avenue/SP Mainline RR Crossing	upgrade	Upgrade railroad crossing; make improvements for vehicle flow for pedestrians and bicyclists	■	■	■	■					✓	✓	✓						Long-range	◆	◆	◆	na	na	\$300,000
303	SE 18th Av - SE 2nd Street to SE 6th Street	rural	Upgrade existing rural road to minor arterial standards; add wide shoulders; add turn lanes at key intersections	■	■	■	■					✓	✓	✓						Long-range	◆	◆	◆	0.3	\$716,000	\$214,800
306	East Lane - SE 13th Avenue to SE 5th Avenue	upgrade	Upgrade to minor arterial road standard; provide turn lanes at key intersections; provide for pedestrians and bicyclists; provide signal at East Lane/SE 5th Avenue	■	■	■	■					✓	✓	✓						Long-range	◆	◆	◆	0.4	\$1,910,000	\$764,000
310	Verde Drive - Yturri Beltline to NW Washington Ave	upgrade	Upgrade to major collector standards; provide for pedestrians and bicyclists	■	■	■	■					✓	✓	✓						Long-range	◆	◆	◆	0.3	\$1,552,000	\$465,600
312	SW 14th Ave - Park Blvd to east of SW 4th St	upgrade	Upgrade to minor collector standards; provide for pedestrians and bicyclists	■	■	■	■					✓	✓	✓						Long-range	◆	◆	◆	0.3	\$1,313,000	\$393,900
314	Verde Drive / NW 4th Avenue Intersection	intersection	Install traffic signal at intersection	■	■	■	■					✓	✓	✓						Long-range	◆	◆	◆	na	na	\$250,000
315	Verde Drive / Idaho Avenue Intersection	intersection	Install traffic signal at intersection	■	■	■	■					✓	✓	✓						Long-range	◆	◆	◆	na	na	\$250,000
316	SW 4th Avenue / SW 12th Street Intersection	intersection	Install traffic signal at intersection	■	■	■	■					✓	✓	✓						Long-range	◆	◆	◆	na	na	\$250,000
317	SW 4th Avenue / Sunset Drive Intersection	intersection	Install traffic signal at intersection	■	■	■	■					✓	✓	✓						Long-range	◆	◆	◆	na	na	\$250,000
318	West Idaho Avenue / NWSW 9th Street Intersection	intersection	Install traffic signal at intersection	■	■	■	■					✓	✓	✓						Long-range	◆	◆	◆	na	na	\$250,000
319	West Idaho Avenue / NWSW 4th Street Intersection	intersection	Install traffic signal at intersection	■	■	■	■					✓	✓	✓						Long-range	◆	◆	◆	na	na	\$250,000

**Total Cost Short Term \$11,444,200**  
**Total Cost Medium Term \$4,192,500**  
**Total Cost Long Term \$3,388,300**

**Grand Total \$19,025,000**

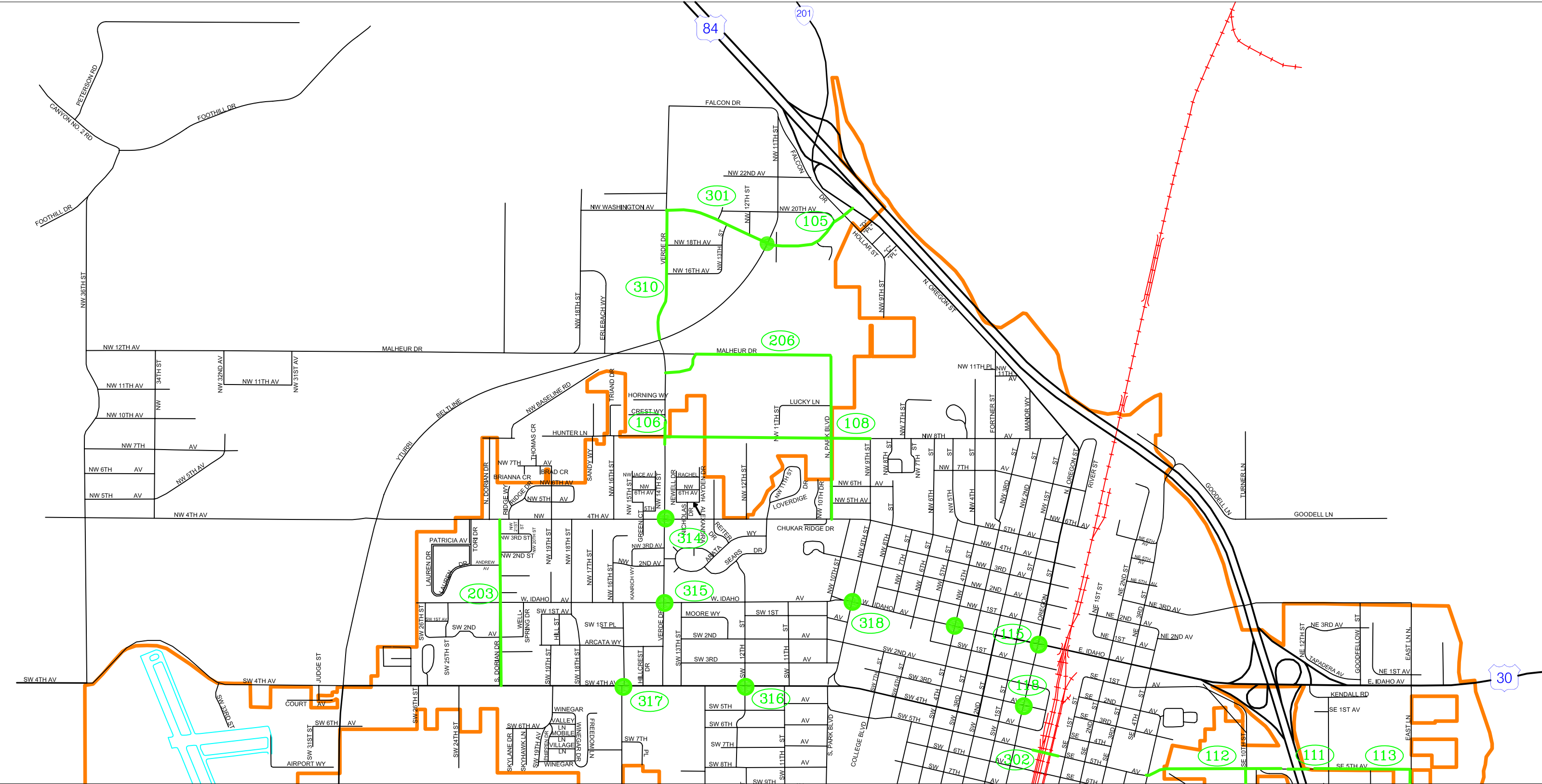

# City of Ontario Transportation System Plan

**LEGEND**  
 Improvement Location ———

NOT TO SCALE

**Figure 6-1a**  
 Location Map of Transportation Projects  
 Still Relevant from Previous TSP

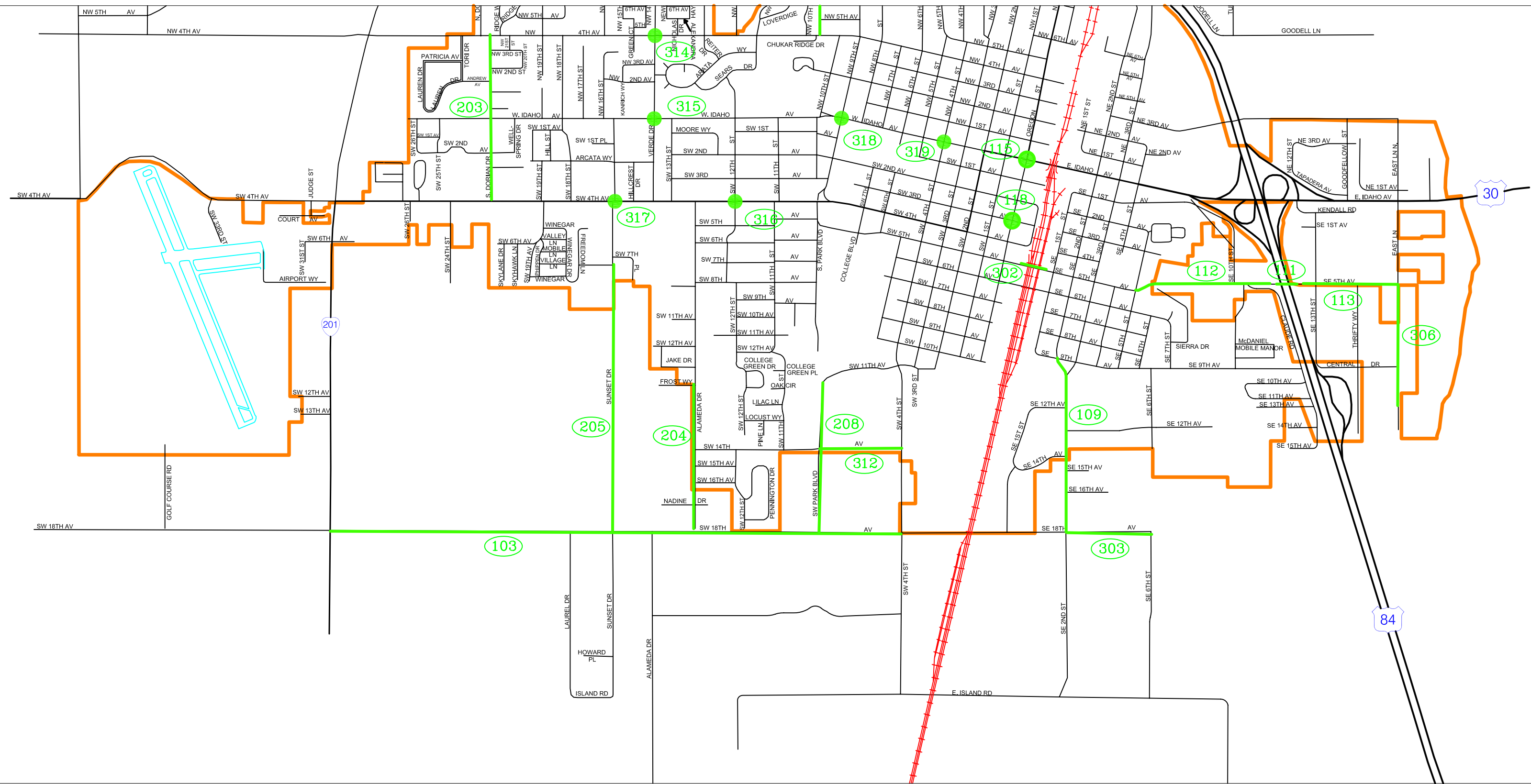

# City of Ontario Transportation System Plan

## LEGEND

Improvement Location ——

NOT TO SCALE

**Figure 6-1b**

Location Map of Transportation Projects  
Still Relevant from Previous TSP

### **6.3. 2025 INTERSECTION IMPROVEMENTS**

The following signalized intersections will need to be improved with additional turn pockets by 2025. These intersections should be monitored periodically to determine when the improvements should take place as well as the exact nature of improvement.

- 4<sup>th</sup> Avenue/Verde Drive
- East Idaho Avenue/East Lane

The following unsignalized intersections will need to be considered for signalization by the Year 2025. These intersections should be monitored periodically to determine when the signalization should take place as well as the exact nature of improvement. These improvements may need to include turn pockets.

- I-84 NB Ramps/Highway 201
- Oregon Street/Washington Avenue
- West Idaho Avenue/Verde Drive
- West Idaho Avenue/SW 4th Street
- SW 5th Avenue/SW 4th Street

**SECTION 7.0**  
**TRANSPORTATION MODAL PLANS**



## **Section 7.0 Transportation Modal Plans**

### **7.1. ROAD PLAN**

#### **7.1.1. Transportation System Plan (TSP) Requirements**

OAR 660-12-020 Elements of Transportation System Plans

(2) (b) A road plan for a system of arterials and collectors and standards for the layout of local roads and other important non-collector road connections. Functional classifications of roads in regional and local TSPs shall be consistent with functional adjacent jurisdictions. The standards for the layout of local roads shall provide for safe and convenient bike and pedestrian circulation necessary to carry out OAR 660-12-045(3)(b). New connections to arterials and state highways shall be consistent with designated access management categories. The intent of this requirement is to provide guidance on the spacing of future extensions and connections along existing and future roads, which are needed to provide reasonably direct routes for bicycle and pedestrian travel. The standards for the layout of local roads shall address:

- (A) Extensions of existing roads;
- (B) Connections to existing or planned roads, including arterials and collectors; and
- (C) Connections to neighborhood destinations.

#### **7.1.2. Functional Classification**

The existing Ontario UGB roadways are classified by the following classifications:

- principal arterial
- minor arterial
- major collector
- minor collector
- local road

These designations will continue to be used for this TSP and future roadway planning by the City of Ontario. Figures 7-1a and 7-1b show the functional classifications for the Ontario UGB roadways.

The state highway system within the Ontario UGB has its own roadway functional classification system. The state highway roadway classification system is previously defined in Section 3.3.2.

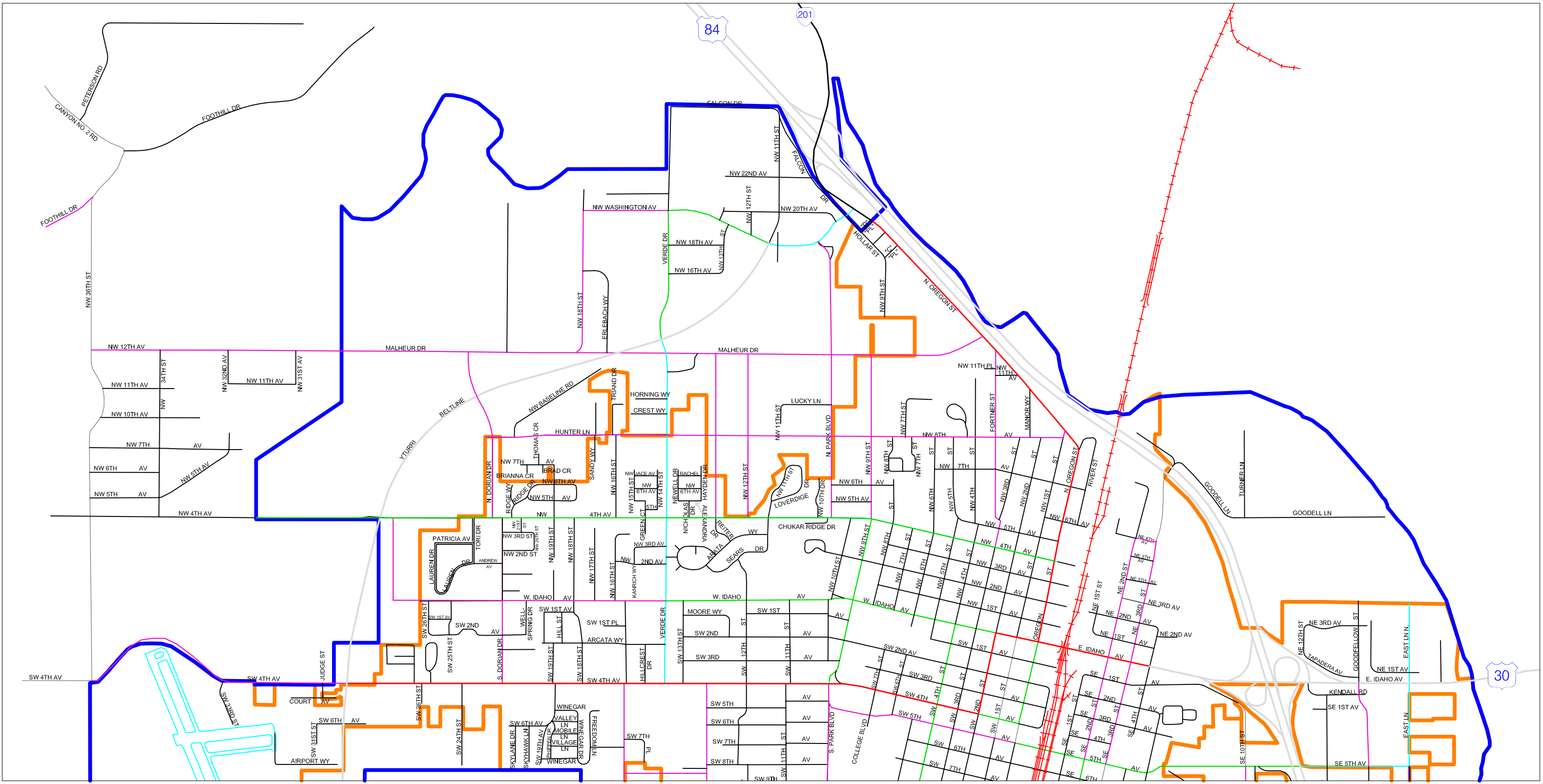

# City of Ontario Transportation System Plan

**Figure 7-1a**  
Roadway Classification

<b>LEGEND</b>			
State Highway		Major Collector	
Principal Arterial		Minor Collector	
Minor Arterial		Local Road	

NOT TO SCALE

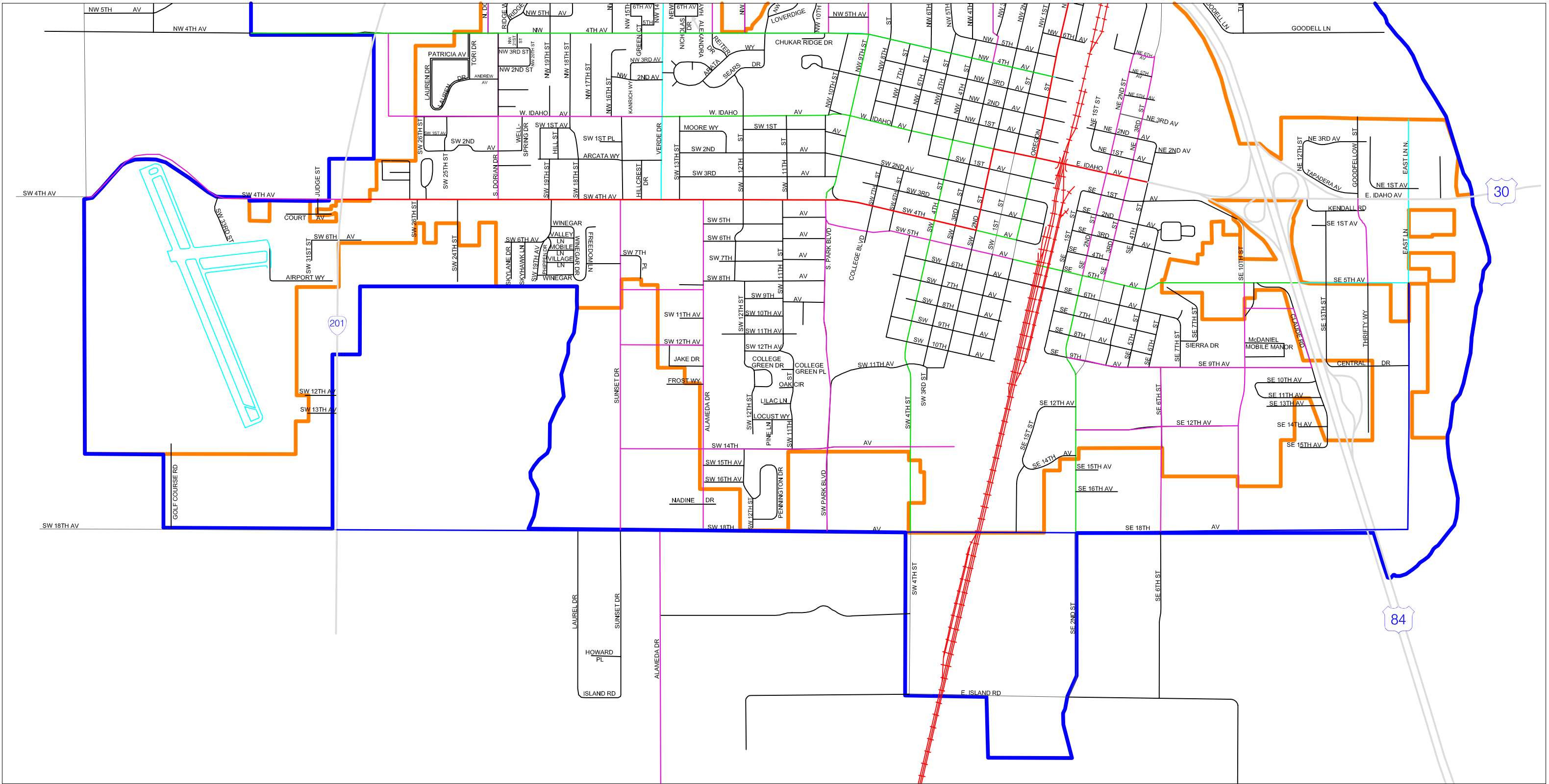

# City of Ontario Transportation System Plan

**Figure 7-1b**  
Roadway Classification

**LEGEND**

- |                    |  |                 |  |
|--------------------|--|-----------------|--|
| State Highway      |  | Major Collector |  |
| Principal Arterial |  | Minor Collector |  |
| Minor Arterial     |  | Local Road      |  |



### 7.1.3. Road Design Standards

Road classification standards relate the design of a roadway to its function. The function is determined by operational characteristics such as traffic volume, operating speed, safety, and capacity. Road standards are necessary to provide a community with roadways which are relatively safe, aesthetic, and easy to administer when new roadways are planned or constructed. They are based on experience, and policies and publications of the profession.

The typical road cross sections by roadway classification are summarized in Table 7-1 and shown in Figures 7-2, 7-3, 7-4, 7-5a, 7-5b, 7-6a, 7-6b, 7-7a, 7-7b and 7-8.

The road and access management design standards for ODOT facilities can be referenced in the 1999 Oregon Highway Plan and Highway Design Manual. Appendix D contains the ODOT access management design standards that can be found in the 1999 Oregon Highway Plan.

**Table 7-1. Street Standards**

Type of Street	Minimum Right of Way Width (feet)	Pavement Width (feet)
Principal Arterial	100'	74'+
Minor Arterial	70'-100'	48'-74'+
Collector	60'-70'	38'-48'
Neighborhood Collector	60'	36
Local Street	50'	32'
Skinny Local Street	50'	28'
Radius For Turn Around at End of Cul-de-Sac	50'	40'

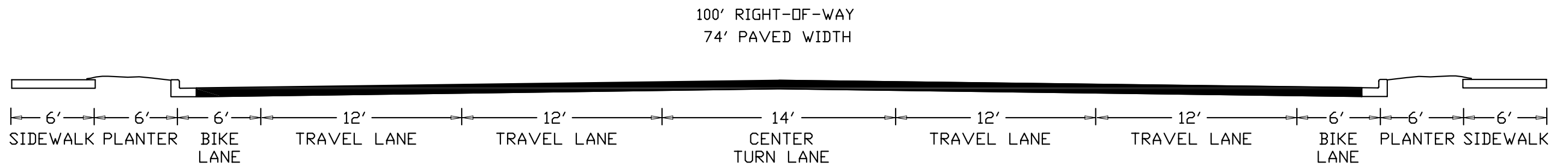

PRINCIPAL ARTERIAL WITH BIKE LANES

**City of Ontario Transportation System Plan**

NOT TO SCALE

**Figure 7-2**  
Typical Roadway Cross Section Standards  
Principal Arterial

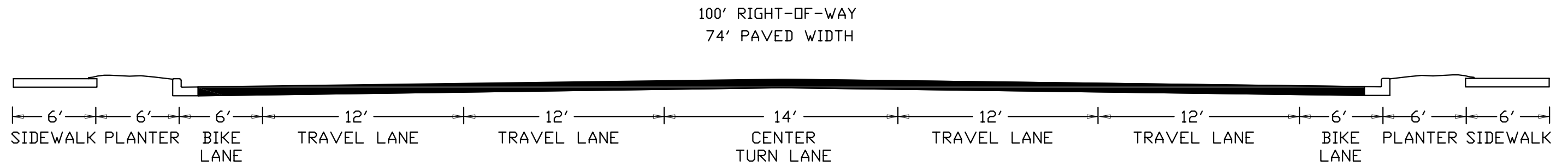

FIVE LANE MINOR ARTERIAL WITH BIKE LANES

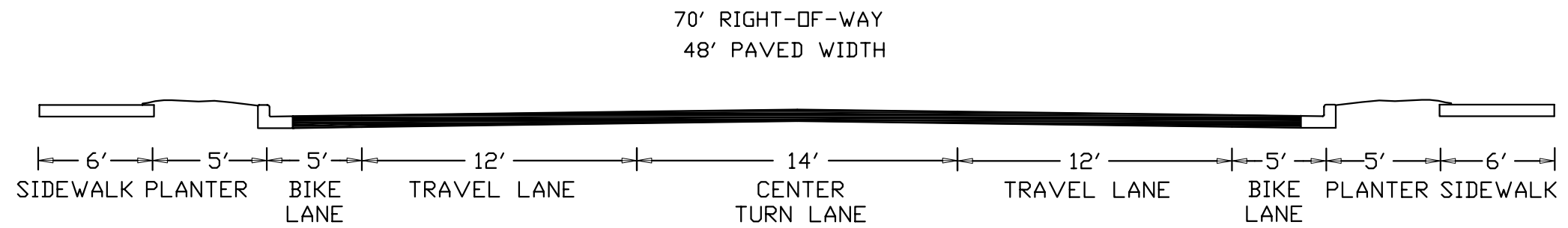

THREE LANE MINOR ARTERIAL WITH BIKE LANES

# City of Ontario Transportation System Plan

**Figure 7-3**  
Typical Roadway Cross Section Standards  
Minor Arterial



NOT TO SCALE

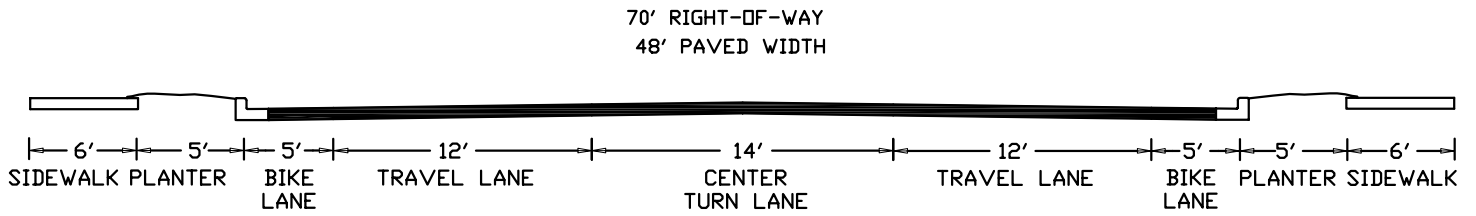

COLLECTOR WITH BIKE LANES

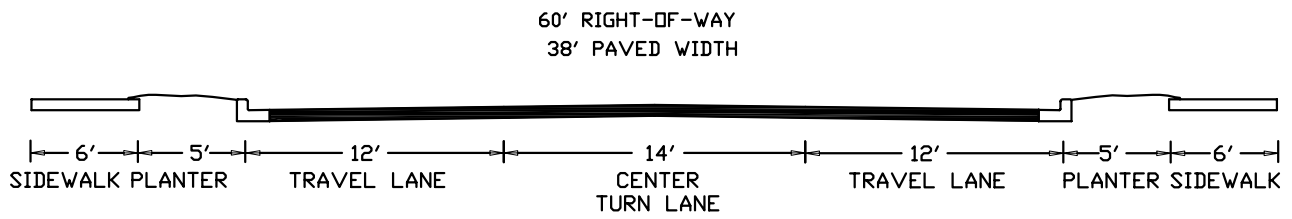

COLLECTOR WITHOUT BIKE LANES

# City of Ontario Transportation System Plan



**Figure 7-4**  
Typical Roadway Cross Section Standards  
Collector

60' RIGHT-OF-WAY

36' PAVED WIDTH



NEIGHBORHOOD COLLECTOR (parking 2 sides)  
FOR STREETS WITH GRADES GREATER THAN 2%

# City of Ontario Transportation System Plan



**Figure 7-5a**  
Typical Roadway Cross Section Standards  
Neighborhood Collector Greater Than 2%



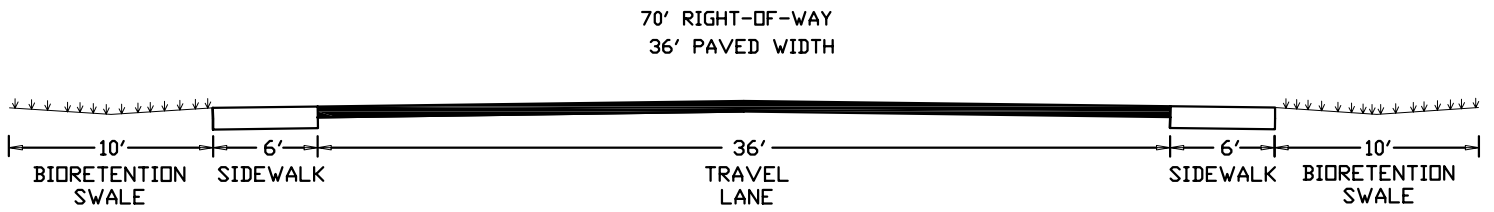

NEIGHBORHOOD COLLECTORS WITH GRADES EQUAL TO OR LESS THAN 2%

## City of Ontario Transportation System Plan



**Figure 7-5b**  
Typical Roadway Cross Section Standards  
Neighborhood Collector Equal to or Less Than 2%

50' RIGHT-OF-WAY  
32' PAVED WIDTH

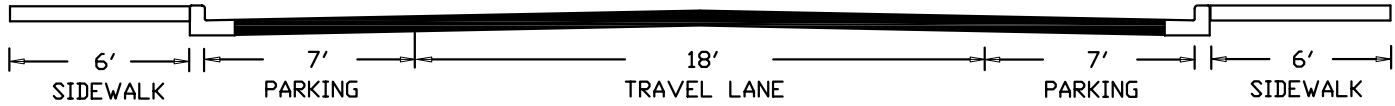

LOCAL STREET (parking 2 sides)  
FOR STREETS WITH GRADES GREATER THAN 2%

# City of Ontario Transportation System Plan



**Figure 7-6a**  
Typical Roadway Cross Section Standards  
Local Street Greater Than 2%

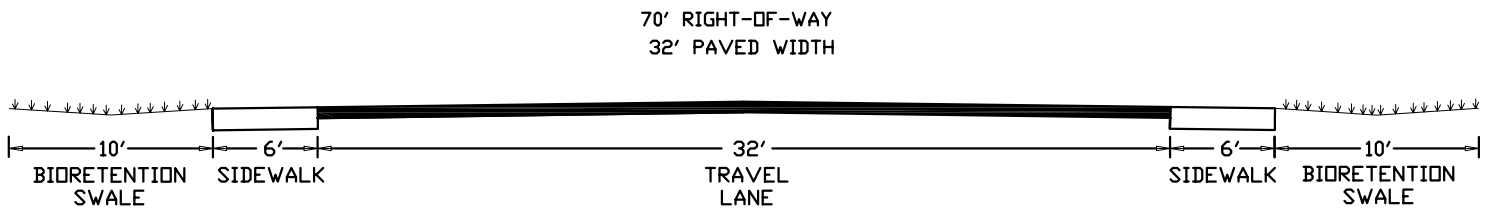

LOCAL STREETS WITH GRADES EQUAL TO OR LESS THAN 2%

## City of Ontario Transportation System Plan



**Figure 7-6b**  
Typical Roadway Cross Section Standards  
Local Street Equal to or Less Than 2%

50' RIGHT-OF-WAY  
28' PAVED WIDTH

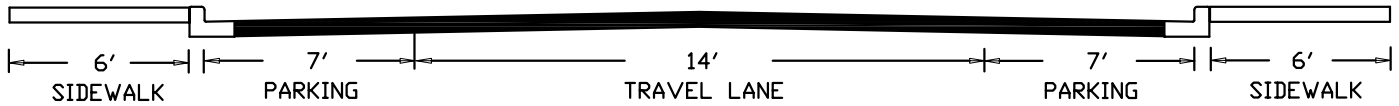

SKINNY LOCAL STREETS (parking 2 sides)  
FOR LOCAL STREETS WITH GRADES GREATER THAN 2%

## City of Ontario Transportation System Plan



**Figure 7-7a**  
Typical Roadway Cross Section Standards  
Skinny Local Street Greater Than 2%

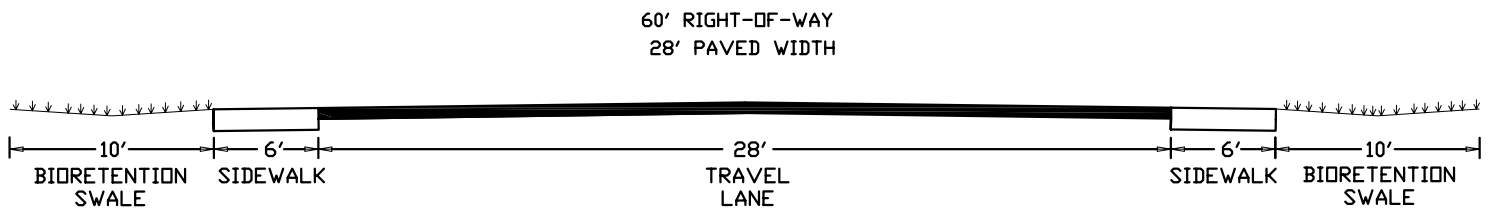

SKINNY LOCAL STREETS WITH GRADES EQUAL TO OR LESS THAN 2%

## City of Ontario Transportation System Plan



**Figure 7-7b**  
Typical Roadway Cross Section Standards  
Skinny Local Street Equal to or Less Than 2%

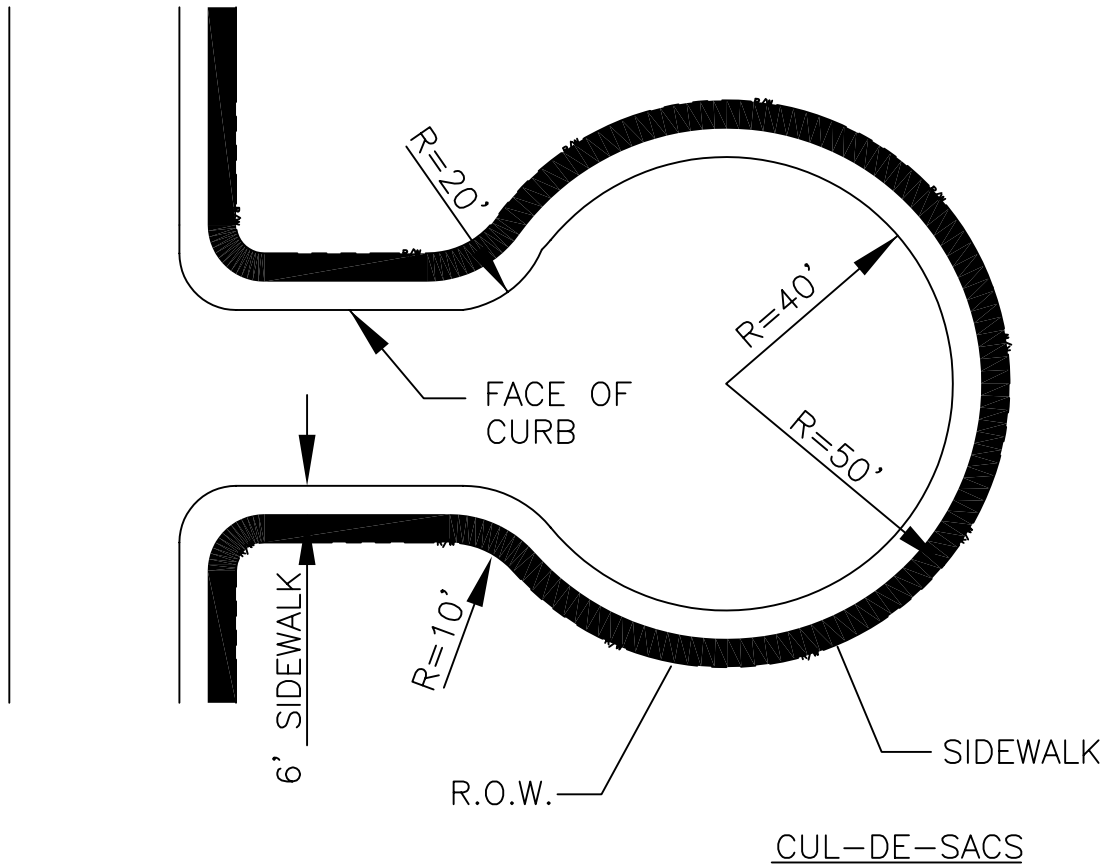

## City of Ontario Transportation System Plan



**Figure 7-8**  
 Typical Roadway Cross Section Standards  
 Cul de Sac Turn Around

#### **7.1.4 Access Management**

Access management is an important tool for maintaining a transportation system. The lack of a prudent access management plan can result in excessive numbers of accesses along arterial roads. Too many access points can diminish the function of an arterial mainly due to delays and safety hazards created by turning movements. Traditionally, the response to this situation is to add lanes to the roadway. The roadway improvements stimulate more business activity and traffic demands. This trend often continues in cyclical fashion and requires significant capital investment. With tightening local, state, and federal funding, there are no longer financial resources to continue this trend. Therefore, the prudent solution is to better manage the roadway through access management to preserve the capacity of the road and balance the need for local access.

The number of access points to a roadway can be restricted and managed by following the techniques described below:

- Restricting spacing between access points (driveways) based on the type of development and speed along the arterial
- Sharing of access points between adjacent properties
- Providing access via the lowest classified road
- Constructing frontage roads to separate local traffic from through traffic
- Providing service drives to prevent spillover of vehicle queues onto the adjoining roadways
- Providing of acceleration, deceleration, and right turn only lanes
- Installing median barriers to control conflicts associated with left turn movements
- Installing side barriers to the property along the arterial to restrict access width to a minimum

Access management is hierarchical, ranging from complete access control on freeways to increasing use of roads for access purposes, parking and loading at the local and collector level. Access management standards are provided in Section 10C-25 in the Ontario City Code.

These access management restrictions are generally not intended to eliminate existing intersections or driveways. Rather, they should be applied as new development occurs. Over time, as land is developed and redeveloped, the access to roadways will meet these guidelines. However, where there is a recognized problem, such as unusual number of collisions, these techniques and standards can be applied to retrofit existing roadways. To summarize, access management strategies consist of managing the number of access points and providing traffic

and facility improvements. The solution is a balanced, comprehensive program that provides reasonable access while maintaining the safety and efficiency of traffic movement.

#### **7.1.5. Local Road Network Plan**

The purpose of the Local Road Network Plan is to identify future right-of-way that the City of Ontario will need in order to have and maintain, as much as possible, a balanced road network in accordance with the Oregon Transportation Rule. The plan designates:

- 1) where existing collector/arterials will be extended or new ones will be added;
- 2) where new local access roads and/or pedestrian ways will be located to provide better connection between existing roads (grid infill); and
- 3) where new local access roads will be located to provide adequate connection to significant local destinations for both automobiles and pedestrians.
- 4) Where rural residential development may occur, local roads will be carried through the full extent of the property and terminate with an emergency turnaround.

Locations for the right-of-way and improvements are designated based on review of the existing road grid, existing parcel boundary locations, physical constraints (such as steep slopes and floodways that might preclude economical road construction) and access management guidelines for access onto major arterials.

Table 7-2 summarizes the local street improvement projects. Figures 7-9a and 7-9b show the locations of these projects. It should be noted that these projects were originally from the 1999 City of Ontario TSP and therefore retain the same numbering system for easy cross-referencing.

#### **7.1.6. Road Improvements**

Please refer to Section 6 for a list and location of the roadway improvement projects.

There are two significant potential projects that should occur within the 20-year planning period of this document. First, adding a third interchange to serve the City at SE 18<sup>th</sup> Avenue. The second project in conjunction with this interchange is to extend SE 18<sup>th</sup> Avenue into Idaho with another Snake River crossing. The rate of future growth will dictate the necessity for these projects; it should be noted that growth in Idaho is creating interest in that State for the extension of SE 18<sup>th</sup> and the new bridge. The City of Ontario is monitoring the situation to determine when these projects will be necessary and is planning accordingly to fund special studies to determine their feasibility. In the next TSP update, these projects will be evaluated and any change in circumstances will be noted.



**Table 7-2  
Local Street Network Improvement Projects**

Proj No.	Project Location	Impvt. Category	Project Description	Project Improves		Project Justification										Project Phasing	Financial Partners			Project Distance (miles)	Unit Cost (per mile)	Project Cost			
				Travel by mode				Access	Economic	Safety	Operations	Truck Traffic	Urban Upgrade	Rural Upgrade	ODOT		County	Ontario							
				Vehicle	Bicycle	Pedestrian	Freight																		
107	NW Park Boulevard - N Oregon Street (relocated) to Malheur Drive	new	Construct new minor collector street; provide turn lanes at key intersections; provide for pedestrians and bicyclists	■	■	■	■	✓					✓								Short-range	◆	0.4	\$1,552,000	\$620,800
114	SW Park Boulevard - SW 11th Avenue to SW 10th Avenue	new	Construct new minor collector street; provide 2-lane cross-section; provide for pedestrians and bicyclists	■	■	■	■	✓		✓											Short-range	◆	0.1	na	\$597,000
117	Goodfellow Street - SE 5th Avenue to Idaho Avenue	new	Construct a new minor collector street; provide 2-lane cross-section, provide for pedestrians and bicyclists	■	■	■	■	✓													Short-range	◆	0.2	\$1,552,000	\$310,400
119	SE 13th Street to Goodfellow Street	New	New local roadway to provide east-west connection in southeast Ontario. Will replace Kendal Street.	■	■	■	■	✓	✓												Short-range	◆	0.1	\$1,552,000	\$155,200
201	North Interchange Project with I-84	rebuild interchange	Upgrade to modern design standards; improve structural standards; improve ramp configuration; signalize ramp terminals; provide for pedestrians and bicyclist	■	■	■	■			✓	✓	✓									Short-range	◆	na	na	\$15,000,000
207	Malheur Drive - Park Boulevard to N Oregon St	new	Construct new minor collector standards; provide for pedestrians and bicyclists; connect with N Oregon St	■	■	■	■	✓					✓								Medium-range	◆	0.4	\$1,910,000	\$764,000
304*	SE 18th Av - SE 6th Street to East Lane (extended)	new	Construct new minor arterial road with new overpass over I-84; provide turn lanes at key intersections; provide for pedestrians and bicyclists *Future studies may warrant an Interchange with I-84	■	■	■	■	✓	✓				✓	✓							Long-range	◆	0.8	na	\$4,776,000
305	East Lane - SE 18th Av to SE 13th Avenue	new	Construct new minor arterial road; provide turn lanes at key intersections; provide for pedestrians and bicyclists	■	■	■	■	✓					✓	✓							Long-range	◆	0.3	\$1,910,000	\$573,000
307	SE 10th Street (extended) - SE 18th Avenue to SE 9th Avenue	new	Construct new minor collector road; provide turn lanes at key intersections; provide for pedestrians and bicyclists	■	■	■	■	✓	✓				✓								Long-range	◆	0.5	\$1,552,000	\$776,000
308	SE 10th Street - SE 9th Avenue to SE 5th Avenue	upgrade	Realign and upgrade to minor collector road standards; improve intersection configuration at SE 5th Avenue; provide for pedestrians and bicyclists; add storm drain improvements	■	■	■	■	✓	✓	✓			✓								Long-range	◆	0.3	na	\$490,000
309	SE Claude Road - SE 9th Avenue to SE 10th Street	upgrade	Realign and upgrade to collector road standards; delete existing intersection with SE 5th Avenue at bridge; provide for pedestrians and bicyclists	■	■	■	■	✓	✓	✓			✓								Long-range	◆	0.3	\$1,910,000	\$573,000
311	Dorian Drive - Hunter Ln to Yturri Beltline to Malheur Dr	new	Construct new street to urban minor collector standards; provide signal and turn lanes at N. Bypass; provide for pedestrians and bicyclists	■	■	■	■	✓		✓			✓								Long-range	◆	0.3	na	\$836,000
313	Hunter Ln - Dorian Drive to NW 19th St	new	Construct new street to urban minor collector standards; provide for pedestrians and bicyclists	■	■	■	■	✓		✓	✓		✓								Long-range	◆	0.3	na	\$836,000
350	SE 18th Avenue Snake River bridge crossing from East Lane to W 1st Street and Highway 95 in Fruitland	new	Construct new minor arterial road with bridge crossing; provide turn lanes at key intersections; provide for pedestrians and bicyclists	■	■	■	■	✓	✓	✓			✓								Long-range	◆	na	na	\$30,000,000
401	Local collector system: connections between Sunset and Alameda	new	Provide new east-west residential collectors (specific locations not yet identified) with through connections; built to new street standards with provisions for pedestrians	■	■	■	■	✓													Development	◆	na		na
402	Local collector system: area between Verde to Park and NW 4th Avenue to Malheur	new	Provide new residential collectors with through connections; built to new street standards with provisions for pedestrians; specific locations not yet determined	■	■	■	■	✓													Development	◆	na		na
403	Local collector system: Fairgrounds area	new	If Fairgrounds relocates, provide new residential collectors with through connections; built to neighborhood collector street standards with provisions for pedestrians; candidate locations include extensions of NW 8th Avenue and NW 9th Street	■	■	■	■	✓													Development	◆	na		na
404	Local collector system: area between SE 2nd Street to SE 10th Street and SE 9th Avenue to SE 18th Avenue	new	Provide new industrial collectors with through connections; built to new street standards with provisions for pedestrians; candidate locations include extensions of SE 12th Avenue and SE 6th Street	■	■	■	■	✓	✓				✓								Development	◆	na		na
405	Local collector system: area between SW 30th Street to SW Dorian and SW 4th Avenue to NW 4th Avenue	new	Provide new residential collectors with through connections; built to new street standards with provisions for pedestrians; candidate locations include extensions of Idaho Ave and a north-south road	■	■	■	■	✓													Development	◆	na		na

Total Cost Short Term      \$16,683,400  
Total Cost Medium Term      \$764,000  
Total Cost Long Term      \$38,860,000

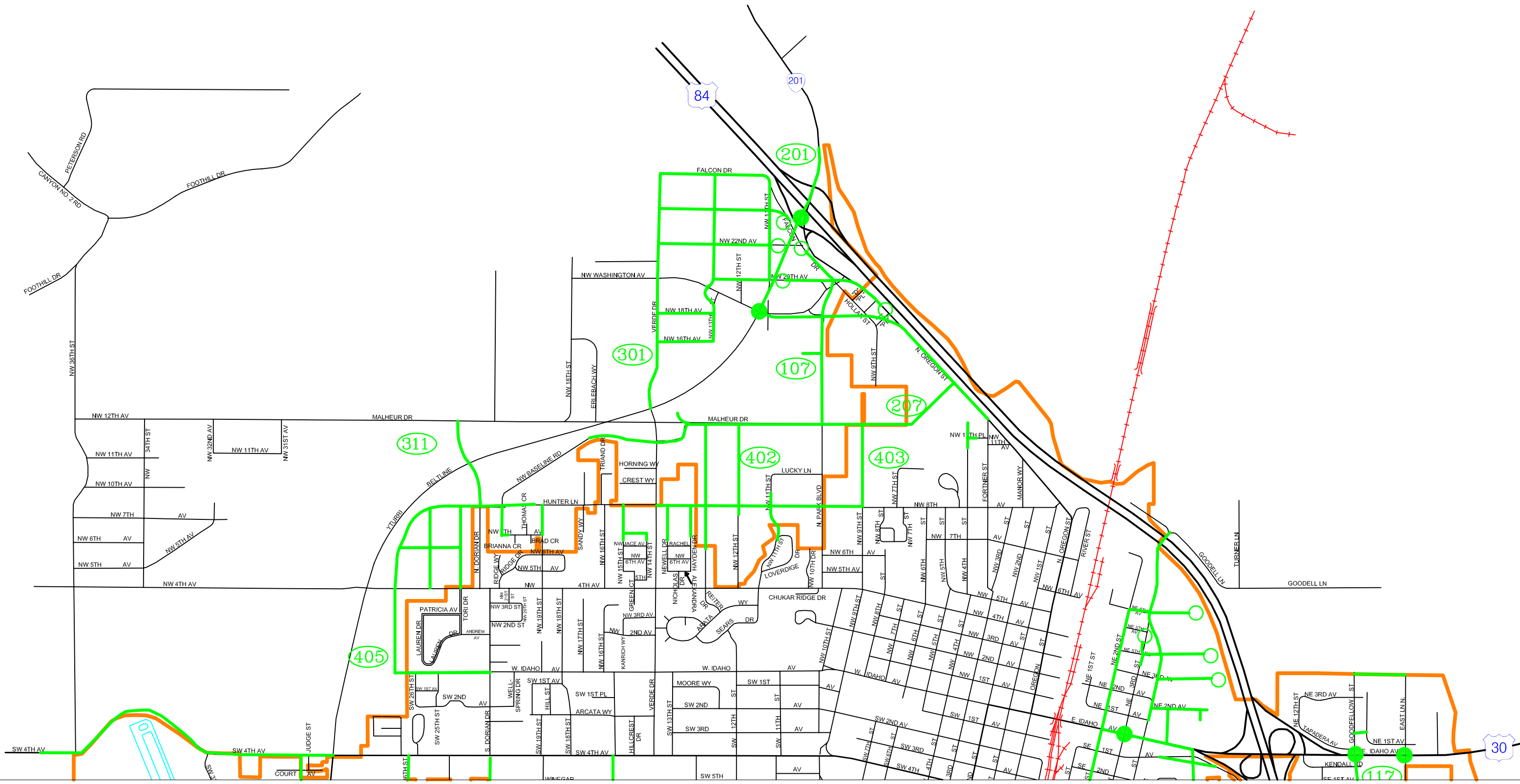

**LEGEND**  
Improvement Location ———

**Figure 7-9a**  
Local Street Network Plan  
EXHIBIT D  
February 21, 2006

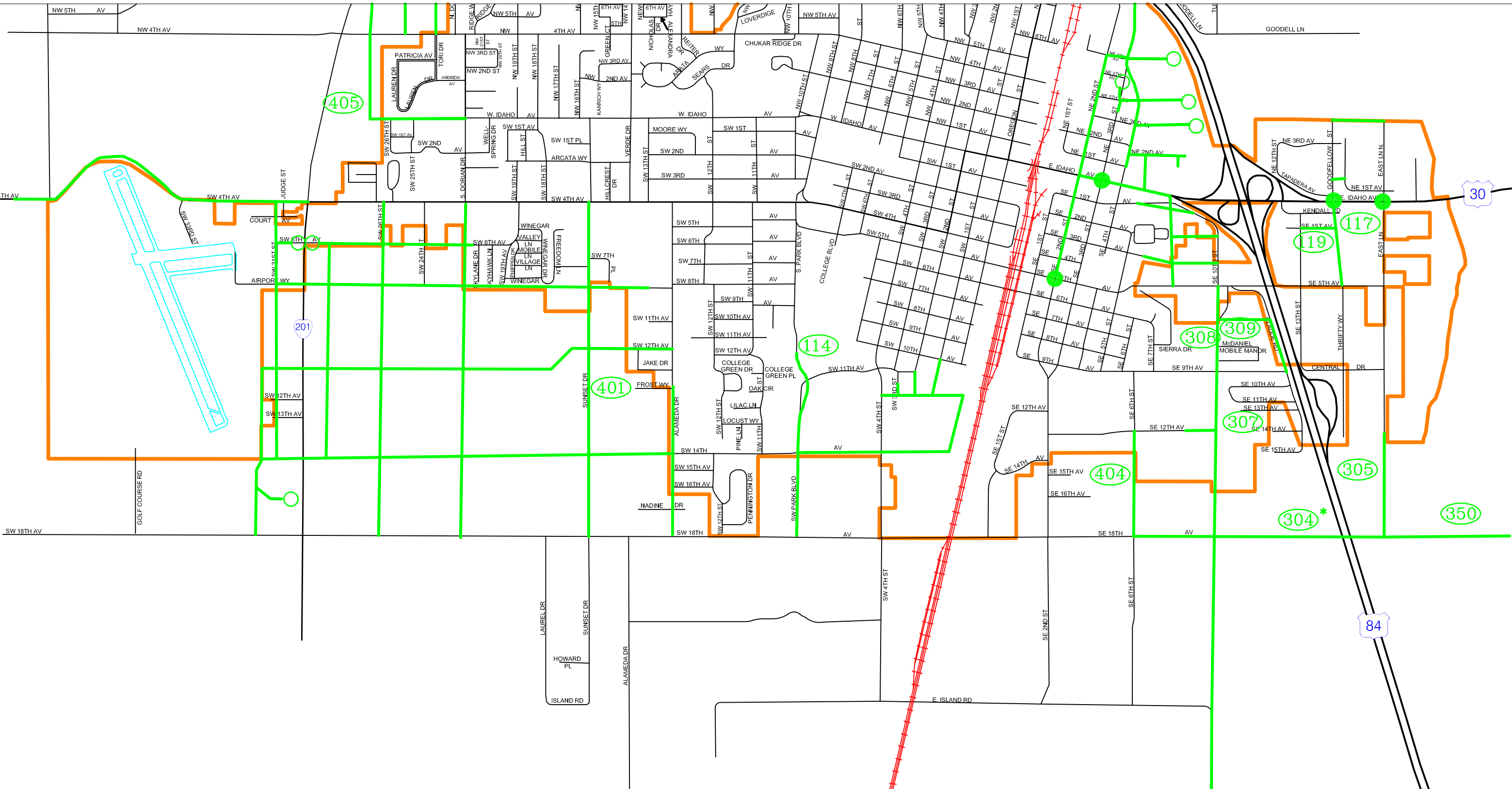

# City of Ontario Transportation System Plan

Figure 7-9b  
Local Street Network Plan  
**EXHIBIT D**  
February 21, 2006

**LEGEND**  
Improvement Location ———

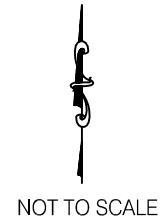

## **7.2. PEDESTRIAN AND BICYCLE SYSTEM PLAN**

### **7.2.1. TPR Requirements**

OAR 660-12-020 Elements of Transportation System Plans

- (2) (d) A bicycle and pedestrian plan for a network of bicycle and pedestrian routes throughout the planning area. The network and list of facility improvements shall be consistent with the requirements of ORS 366.514.

OAS 660-12-045 Implementation of the Transportation System Plan

- (6) In developing a bicycle and pedestrian circulation plan as required by 660-12-020(2)(d), local governments shall identify improvements to facilitate bicycle and pedestrian trips to meet local travel needs in developed areas. Appropriate improvements should provide for more direct, convenient and safer bicycle or pedestrian travel within and between residential areas and neighborhood activity centers (i.e. schools, shopping, transit stops). Specific measures include, for example, constructing walkways between cul-de-sacs and adjacent roads, providing walkways between buildings, and providing direct access between adjacent uses.

### **7.2.2. Non-Motorized Facility Standards**

There are many types of non-motorized facilities. These facilities include but are not limited to:

- Shared roadway
- Shoulder bikeway
- Bike Lane
- Multi-use path
- Sidewalk

The City of Ontario shall use the standards for non-motorized facilities that are contained in the Oregon Bicycle and Pedestrian Plan, ODOT, June 14, 1995. Figure 7-10 shows the shared roadway bike facility. Figure 7-11 shows the shoulder bikeway facility. Figure 7-12 show the bike lane facility. Figure 7-13 shows the multi-use path facility. Figures 7-10 through 7-13 are conceptual in nature. The *Oregon Bicycle and Pedestrian Plan* should be used as a design standard.



## City of Ontario Transportation System Plan

**Figure 7-10**  
Shared Roadway Bike Facility

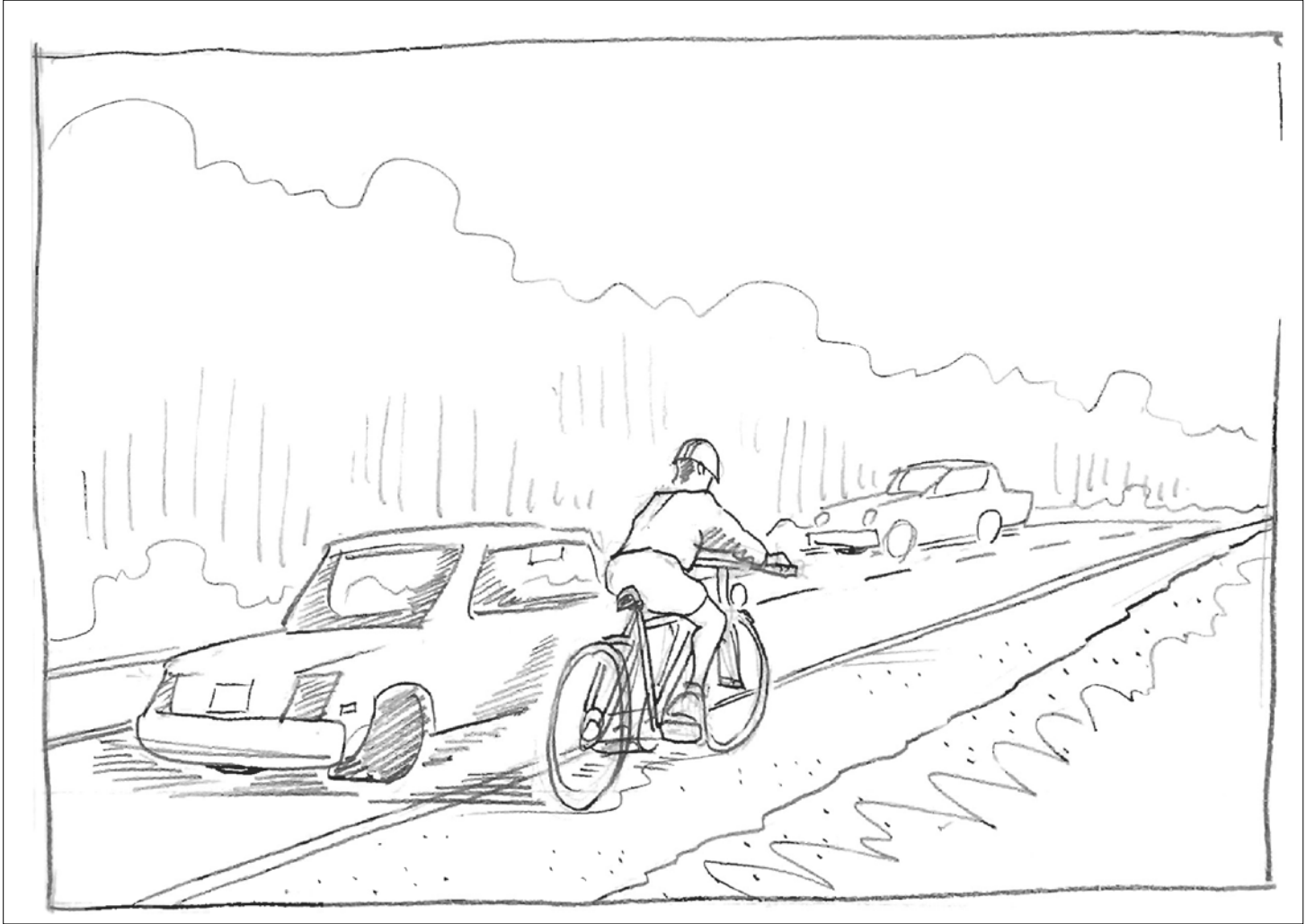

## City of Ontario Transportation System Plan

**Figure 7-11**  
Shoulder Bikeway Facility



NOT TO SCALE

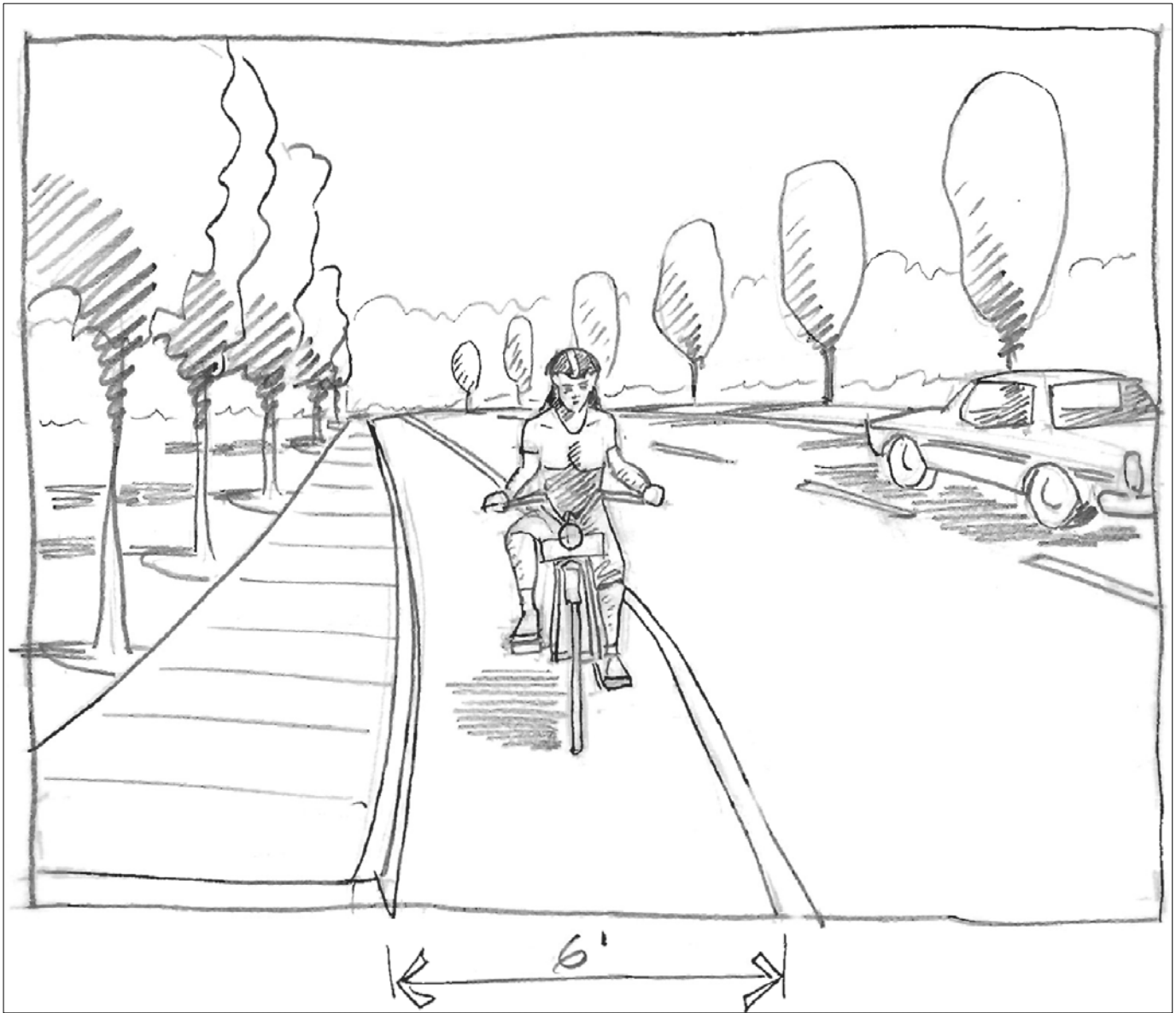

## City of Ontario Transportation System Plan

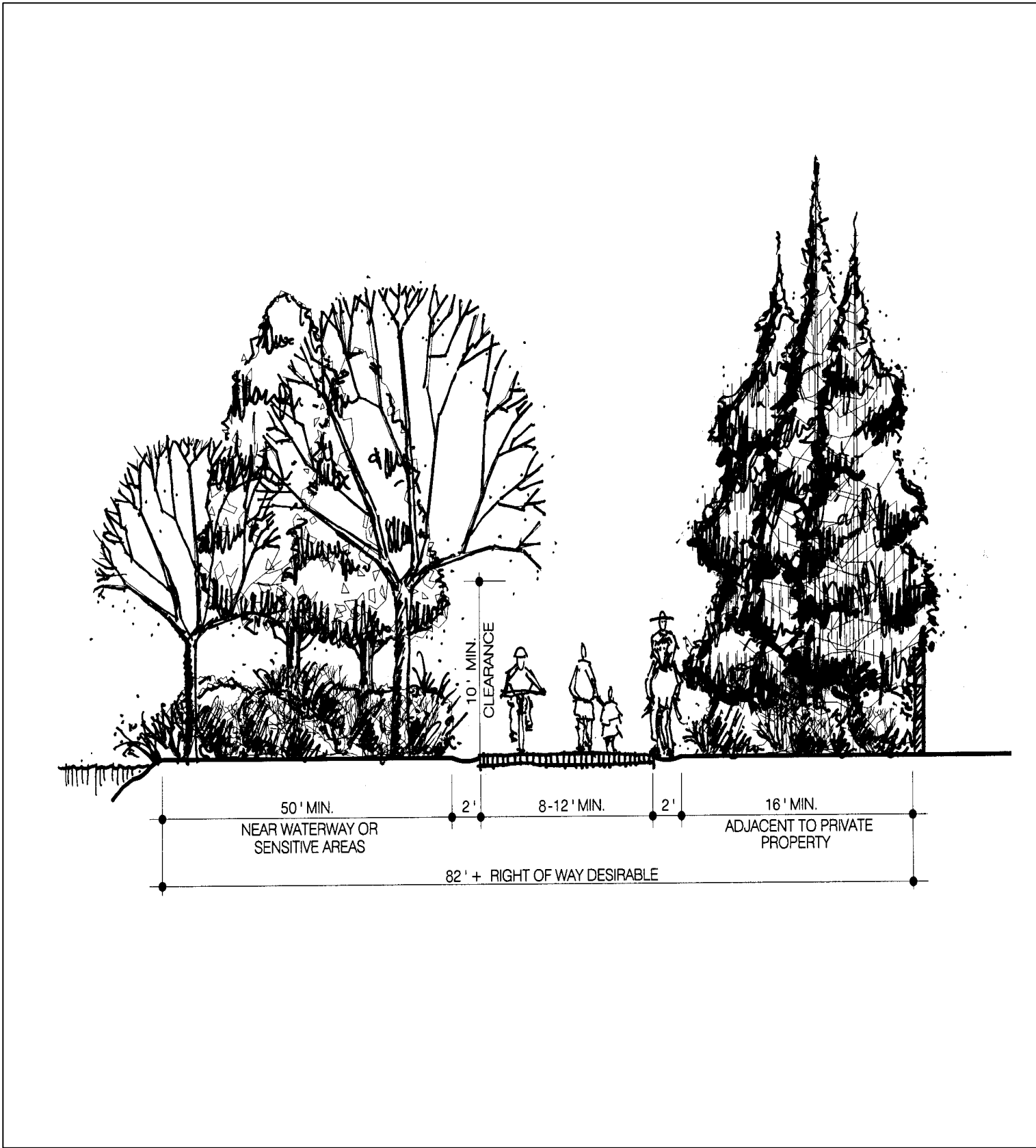

# City of Ontario Transportation System Plan

**Figure 7-13**  
Multi-Purpose Trail



### 7.2.3. Non-Motorized Improvements

The primary focus of the non-motorized improvement plan is three-fold. First, adequate sidewalks and bike lanes should be provided along major travel routes. This means that the non-motorized component of the arterial system, which includes principal arterials, minor arterials, and collectors, should have adequate sidewalks and bike lanes to accommodate pedestrians, bicyclists, and other non-motorized modes of travel. Second, continuity within the non-motorized system is a must. This means that missing sections of sidewalks and bike lanes along major travel routes should be installed so that it is possible to travel along an adequate facility for the duration of a trip. It also means that sidewalks and bike lanes in poor condition should be repaired to encourage non-motorized travel. Facilities in poor condition discourage use of that facility. The third focus of the non-motorized plan is to provide adequate connectivity between major activity centers that generate non-motorized trips. This means that land uses such as schools and neighborhoods need to be connected. Also the downtown core with adjacent neighborhoods should be connected.

Recreational facilities for non-motorized travel could be another focus. However, since the basic need defined above is relatively great, the focus of the non-motorized plan will be to focus on the basic needs.

Table 7-3 contains a list of bicycle and pedestrian projects within the Ontario UGB.

Figures 7-14a and 7-14b show the locations of the bicycle and pedestrian improvement projects.

**Table 7-3  
Bicycle and Pedestrian Capital Improvement List and Cost**

No.	Street	To	From	Length (mi.)	Description (from Bicycle and Pedestrian Plan)	Cost, \$K-Source
<b>High Priority</b>						
1A	E. Idaho Ave.	Oregon St.	NE 2nd St.	0.22	Improve sidewalk access, security and attractiveness.	\$35-State
1B	E. Idaho Ave.	NE 2nd St.	I-84	0.31	Repair pavement and sidewalks, stripe wide outside lanes, manage access.	\$115-State
1C	E. Idaho Ave.	I-84	Snake River Bridge	0.78	Add sidewalks and bike lanes.	\$287-State
2A	SW 4th Ave.	Cairo Blvd.	SW 2nd St.	1.93	Repair sidewalks, stripe bike lanes, manage access.	\$25-State
2B	SW 4th Ave.	SW 2nd St.	Oregon St.	0.11	Repair sidewalks, stripe bike lanes in 3-lane section.	\$7-State
3A	N. Oregon St.	North UGB	NW 8th Ave.	0.93	Restripe with shoulders	\$0
3B	N. Oregon St.	NW 8th Ave.	NW 2nd Ave.	0.53	Repair sidewalks, stripe bike lanes in 3-lane section.	\$46-State
3C	N. Oregon St.	NW 2nd Ave.	Idaho St.	0.12	Repair sidewalks, stripe bike lanes in 3-lane section.	\$25-State

**Table 7-3 Continued  
Bicycle and Pedestrian Capital Improvement List and Cost**

<b>No.</b>	<b>Street</b>	<b>To</b>	<b>From</b>	<b>Length (mi.)</b>	<b>Description (from Bicycle and Pedestrian Plan)</b>	<b>Cost, \$K-Source</b>
<b>Medium Priority</b>						
3D	S. Oregon St.	Idaho St.	SW 4th Ave.	0.25	Improve intersections, repair bike racks.	\$4-State
4A	E. Idaho Ave.	Verde Dr.	NW 9th St.	0.49	Repair sidewalks, stripe bike lanes.	\$38-Local
4B	E. Idaho Ave.	NW 9th St.	NW 4th St.	0.38	Repair sidewalks, stripe bike lanes.	\$31-Local
4C	E. Idaho Ave.	NW 4th St.	NW 2nd St.	0.12	Repair sidewalks, stripe bike lanes.	\$4-Local
4D	E. Idaho Ave.	NW 2nd St.	Oregon St.	0.12	Stripe bike lanes.	0
5	SE 5th Ave.	SE 5th St.	East Ln.	0.8	Widen to 32 ft.	\$125-Local
6	NW 9th St.	NW 8th Ave.	SW 4 <sup>th</sup> St.	0.76	Complete sidewalks, stripe bike lanes.	\$115-Local
7	Park Blvd.	SW 4th Ave.	SW 5 <sup>th</sup> Ave.	0.06	Complete sidewalks, stripe bike lanes.	\$11-Local
8	NW 4th Ave.	Verde Dr.	N. Oregon St.	0.49	Complete sidewalks, stripe bike lanes.	\$187-Local
9	Verde Dr. <sup>1</sup>	NW 20th Ave.	NW 4 <sup>th</sup> Ave.	0.93	Widen to 34 ft.	\$160-Local
10	NW 20th Ave.	Verde Dr.	N. Oregon St.	0.53	Widen to 34 ft.	\$85-Local
11	SW 18th Ave.	West UGB	SW 4 <sup>th</sup> St.	1.74	Widen to 34 ft.	\$330-Local
12	SW 4th St.	SW 10th Ave.	SW 18th Ave.	0.58	Widen to 34 ft.	\$130-Local
13	Dorian Dr.	NW 4th Ave.	SW 4 <sup>th</sup> Ave.	0.5	Widen to 34 ft.	\$80-Local
<b>Low Priority</b>						
14	Fortner St.	N. Oregon St.	NW 4 <sup>th</sup> Ave.	0.6	Complete sidewalks.	\$130-Local
15	SE 2nd St.	E. Idaho Ave.	SE 18 <sup>th</sup> Ave.	1.08	Complete sidewalks north, widen to 34 ft. south.	\$255-Local
16	SE 3rd St.	E. Idaho Ave.	SE 2nd St.	0.59	Complete sidewalks.	\$150-Local
17	SW 4th St.	SW 4th St.	SW 10th Ave.	0.36	Complete sidewalks.	7\$0-Local
18	SW 5th St.	SW 4th St.	SW 10th Ave.	0.36	Complete sidewalks.	\$50-Local
19	SW/SE 6th Ave.	SW 5th St.	SE 7th St.	0.86	Complete sidewalks (+resurface pavement).	\$150-Local
20	SW 12th St.	Sears Dr.	SE 4th Ave.	0.38	Complete sidewalks (+resurface pavement).	\$40-Local

**Table 7-3 Continued  
Bicycle and Pedestrian Capital Improvement List and Cost**

No.	Street	To	From	Length (mi.)	Description (from Bicycle and Pedestrian Plan)	Cost, \$K-Source
<b>Medium Priority</b>						
21	NW 8 <sup>th</sup> Ave.	NW 6 <sup>th</sup> St.	N. Oregon St.	0.42	Complete sidewalks and ADA improvements.	\$125-Local
22	NW 6 <sup>th</sup> St.	SW 1 <sup>st</sup> Ave.	NW 8 <sup>th</sup> Ave.	0.59	Complete sidewalks, ADA improvements and stripe bike lanes.	\$170-Local
23	SW 6 <sup>th</sup> St.	SW 5 <sup>th</sup> Ave.	SW 2 <sup>nd</sup> Ave.	0.20	Complete sidewalks, ADA improvements and stripe bike lanes.	\$50-Local
24	SW 12 <sup>th</sup> St.	Locust Way	SW 4 <sup>th</sup> Ave.	0.25	Complete sidewalks, ADA improvements and stripe bike lanes.	\$150-Local
25	Alameda Drive	SW 8 <sup>th</sup> Ave.	SW 18 <sup>th</sup> Ave.	0.75	Develop to minor collector standards.	\$950-Local
26	SW 8 <sup>th</sup> Ave.	SW 12 <sup>th</sup> St.	Alameda Drive	0.10	Complete sidewalks, ADA improvements and stripe bike lanes.	\$30-Local
27	Locust Way	SW 11 <sup>th</sup> St.	SW 12 <sup>th</sup> St.	0.10	Complete sidewalks, ADA improvements and stripe bike lanes.	\$40-Local
28	SW 11 <sup>th</sup> St.	SW 14 Ave.	Locust Way	0.10	Complete sidewalks, ADA improvements and stripe bike lanes.	\$20-Local
29	SW 14 <sup>th</sup> Ave.	SW 11 <sup>th</sup> St.	Park Blvd.	0.10	Complete sidewalks, ADA improvements and stripe bike lanes.	\$20-Local
30	Park Blvd.	SW 11 <sup>th</sup> Ave.	SW 14 <sup>th</sup> Ave.	0.23	Develop to minor collector standards.	\$500-Local
31	SW 11 <sup>th</sup> Ave.	Park Blvd.	SW 2 <sup>nd</sup> St.	0.34	Complete sidewalks, ADA improvements and stripe bike lanes.	\$500-Local
32	SW 2 <sup>nd</sup> St.	SW 5 <sup>th</sup> Ave.	SW 11 <sup>th</sup> Ave.	0.36	Complete sidewalks, ADA improvements and stripe bike lanes.	\$105-Local
33	Claude Rd.	SE 9 <sup>th</sup> Ave.	SE 11 <sup>th</sup> Ave.	0.10	Complete sidewalks, ADA improvements and stripe bike lanes.	\$160-Local
34	SE 9 <sup>th</sup> Ave.	SE 7 <sup>th</sup> St.	Claude Rd.	0.39	Complete sidewalks, ADA improvements and stripe bike lanes.	\$95-Local
35	SE 7 <sup>th</sup> St.	SE 6 <sup>th</sup> Ave.	SE 9 <sup>th</sup> Ave.	0.14	Complete sidewalks, ADA improvements and stripe bike lanes.	\$20-Local
36	SE 5 <sup>th</sup> St.	SE 5 <sup>th</sup> Ave.	SE 6 <sup>th</sup> Ave.	0.10	Complete sidewalks, ADA improvements and stripe bike lanes.	\$20-Local
37	NW 4 <sup>th</sup> Ave.	West UGB	Verde Dr.	1.00	Develop to major collector standards.	\$600-Local
38	W. Idaho Ave.	Verde Dr.	Dorian Dr.	0.50	Complete sidewalks, ADA improvements and stripe bike lanes.	\$40-Local
39	Verde Dr.	NW 4 <sup>th</sup> Ave.	SW 4 <sup>th</sup> Ave.	0.50	Complete sidewalks, ADA improvements and stripe bike lanes.	\$130-Local
40	NW Washington Ave.	N. Oregon St.	Yturri Beltline	0.30	Develop to major collector standards.	\$650-Local
41	SE / SW 5 <sup>th</sup> Ave.	SW 12 <sup>th</sup> St.	SE 5 <sup>th</sup> St.	1.27	Develop to major/minor collector standards.	\$350-Local

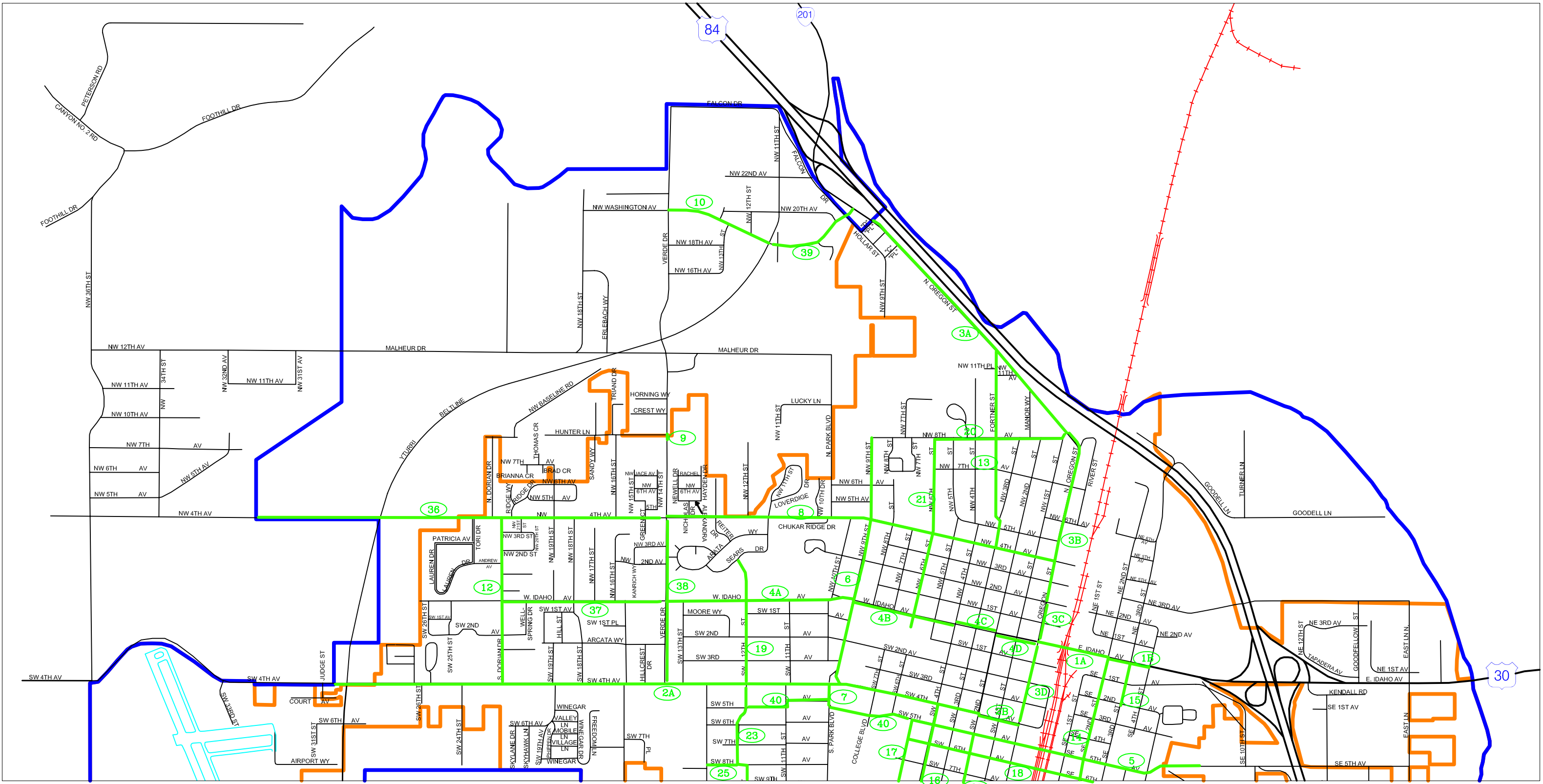

# City of Ontario Transportation System Plan

## LEGEND

Improvement —

NOT TO SCALE

**Figure 7-14a**  
Bicycle and Pedestrian Improvement Project Locations

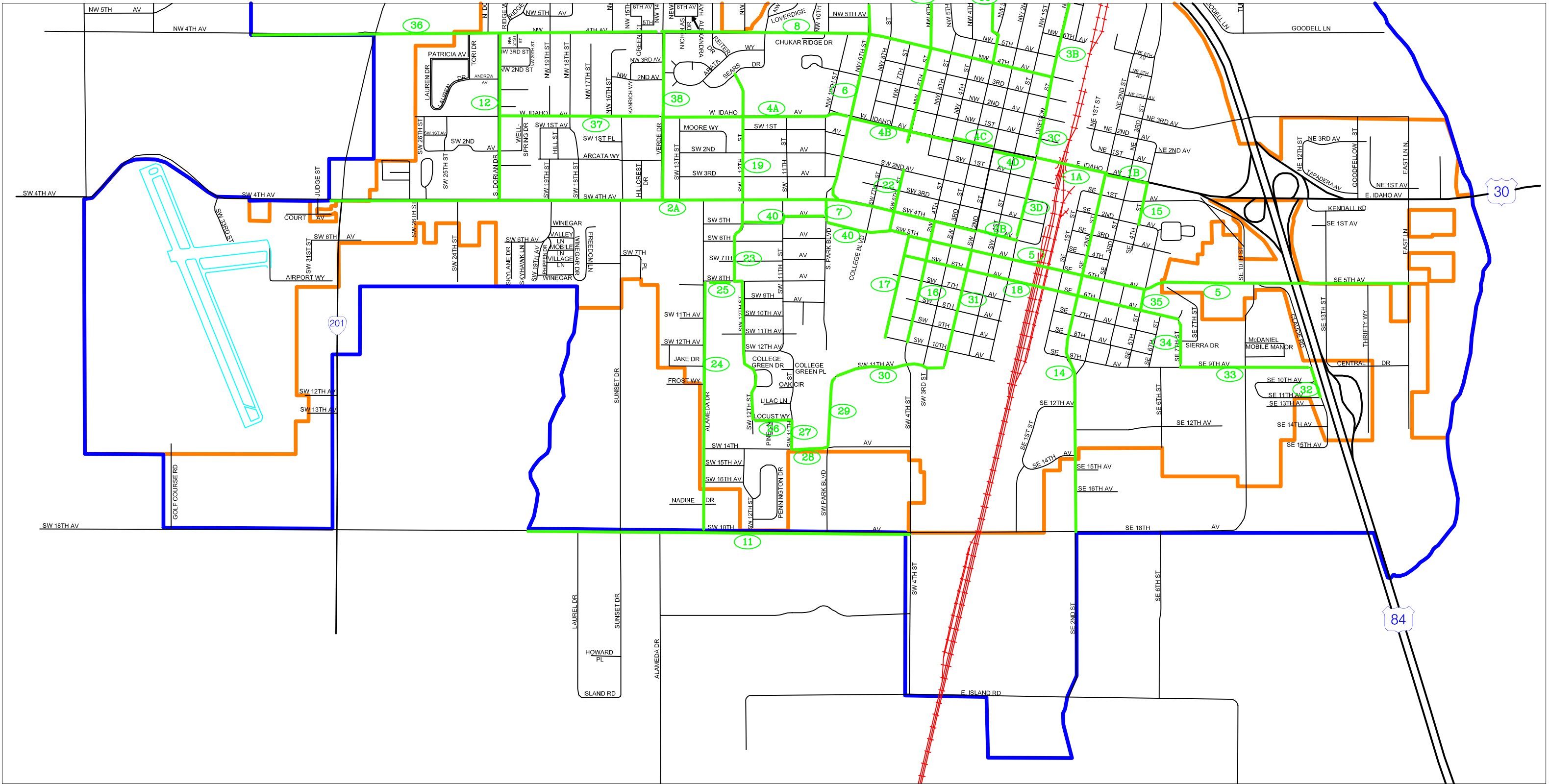

# City of Ontario Transportation System Plan

**LEGEND**  
Improvement —

**Figure 7-14b**  
Bicycle and Pedestrian Improvement Project Locations



NOT TO SCALE

## **7.3. PUBLIC TRANSPORTATION PLAN**

### **7.3.1. Transportation Planning Rule (TPR) Requirements**

#### **OAR 660-12-020 Elements of Transportation System Plans**

(2) (c) A public transportation plan which:

- (A) Describes public transportation services for the transportation disadvantaged and identifies service inadequacies.
- (B) Describes intercity bus and passenger rail service and identifies the location of terminals.
- (C) For areas within an urban growth boundary which have public transit service, identifies existing and planned transit trunk routes, exclusive transit ways, terminals and major transfer stations, major transit stops, and park-and-ride stations. Designation of stop or station locations may allow for minor adjustments in the location of stops to provide for efficient transit or traffic operation or to provide convenient pedestrian access to adjacent or nearby uses.
- (D) For areas within an urban area containing a population of greater than 25,000 persons, not currently served by transit, evaluates the feasibility of developing a public transit system at build out. Where a transit system is determined to be feasible, the plan shall meet the requirements of subsection 2(c)(C) of this section.

### **7.3.2. Types of Public Transportation and Recommended Services**

Public transportation may include the following services and facilities:

- Intra- and inter-city fixed route systems: deviated fixed-route scheduled bus, rail, light rail, and park-and-ride express services.
- Demand response services which primarily serve the disabled, elderly, or other transportation disadvantaged individuals.
- Rideshare/Transportation Demand Management program: carpool, vanpool, bus pool matching services; preferential parking programs; and reduced parking fees.
- Other: taxi services, privately owned inter-city bus lines or shuttle services.

The best mix of services in any community or planning area will depend on the needs of the service population, spatial distribution of the service population, economic factors, and the existing transportation system and policies.

The Malheur Transportation Service, a private non-profit organization, helps coordinate transportation providers within the county. It coordinates city bus, senior center van service, and

volunteer services which provide rides for medical purposes and transportation for developmentally disabled people to a worksite.

There are no plans to expand the public transportation service within Ontario at this time. However, the City of Ontario should support the implementation of public transportation programs when the need arises and encourage people to travel by modes other than the single occupancy vehicle.

Greyhound Lines currently provide bus service for Ontario, Oregon. Greyhound currently operates a summer schedule with three buses traveling daily between Ontario and Portland, one bus daily between Ontario and Seattle, Washington and four buses daily between Ontario and Boise, Idaho. During other seasons, Greyhound operates two buses daily in each direction on I-84. These runs provide westbound connections to Pendleton, Portland, and Seattle, and eastbound connections to Boise.

There are no plans to expand the Greyhound Bus Line service in Ontario at this time. However, the city of Ontario should encourage the use of the bus line for commuting to Pendleton, Portland, Seattle, and Boise.

### **7.3.3. Transportation Demand Management**

Transportation Demand Management (TDM) is a technique applied to peak travel times to help reduce the use of the transportation network system. Through transportation demand management (TDM), peak travel demands can be reduced or spread to more efficiently use the transportation system, rather than building new or wider roadways. Techniques that have been successful and could be initiated to help alleviate some traffic congestion include carpooling and vanpooling, alternative work schedules, bicycle and pedestrian facilities, and programs focused on high-density employment areas.

Implementing TDM strategies include bicycle and sidewalk improvements recommended earlier in this chapter. By providing these facilities, the City of Ontario is encouraging people to travel by modes other than the automobile.

Because intercity commuting is a factor in Malheur County, residents who live in Ontario and work in other cities should be encouraged to carpool with a fellow coworker or someone who works in the same area. Implementing a local carpool program in Ontario alone is not practical; however, a county-wide carpool program is possible. The City of Ontario should support state and county carpooling and vanpooling programs that could further boost carpooling ridership.

No costs have been estimated for the TDM plan. Grants may be available to set up programs; other aspects of transportation demand management can be encouraged through ordinance and policy.

The Snake River Correction Institute is one of the major employers in Ontario that is working towards a TDM program that could establish a standard for other large employers to follow. The *Transportation Demand Management Plan for Snake River Correctional Institution in Ontario, Oregon* conducted by DEA in March 1997, concluded the potential exists for vanpool and carpool services at the SRCI. The study recommended:

- SRCI provide simple carpool matching services supported by preferential parking in-house;
- SRCI should work with Malheur County Transportation System to offer a vanpool program to its employees; and
- SRCI should work with state agencies as employers to investigate the possibility of offering workers that vanpool a subsidy. SRCI should work with the Department of Corrections, the Governor's Office, ODOT and other state agencies to explore ways to provide state employees incentives to use alternatives to driving alone.

The TDM program, if established for SRCI has the potential to provides an example for other large employers in the area to follow. When the program is shown to be effective, the City should encourage other major employers to follow SRCI's lead and establish TDM programs of their own.

## **7.4. AIR, RAIL, WATER AND PIPELINE PLAN**

### **7.4.1. TPR Requirements**

OAR 660-12-020 Elements of Transportation System Plans

(2) (e) An air, rail, water and pipeline transportation plan which identifies where public use airports, mainline and branchline railroads and railroad facilities, port facilities, and major regional pipelines and terminals are located or planned within the planning area. For airports, the planning are shall include all areas within airport imaginary surfaces and other areas covered by state or federal regulations.

### **7.4.2. Air Service**

Scheduled service was discontinued at the Ontario Municipal Airport many years ago. Good service for Ontario residents is available at the Boise International Airport. However, the importance of the Ontario Airport should not be underestimated. It is useful for corporate, general aviation, and air taxi. Precautions should be used to protect the infrastructure and future use of the airport.

The 1997 *Oregon Continuous Aviation Plan* contains projections for the year 2014 for Oregon's airports. Three forecasts were created to determine the number of aircraft that would be based at



the facility in 2014. The forecasts were 50 aircraft (based on historical trends), 59 aircraft (using overall state forecasts and assigning a portion to the facility), and 91 aircraft (extrapolating from the 1992 master plan). A total of 13,750 operations were forecast to take place at the airport in 2014. In addition, the 1992 *Ontario Municipal Airport Master Plan* calls for expanding the length of the runway to 5,000 feet.

### **7.4.3. Rail Service**

#### ***Rail Freight Service***

Rail freight service in Ontario is provided by the Union Pacific Railroad (UP). The UP's system extends from Washington to California to Illinois to Louisiana. The UP mainline through Ontario is one of the more intensely used rail lines in Oregon connecting Washington and Oregon with the remainder of its system. Even freight originating in Portland and destined for California on the UP runs through Ontario.

Malheur County produces relatively modest amounts of rail freight traffic in comparison to the volume of traffic passing through Ontario. The Oregon Rail Freight Plan indicates less than one-half million tons annually is destined for, or originates in, Malheur County. Most of Malheur County's rail freight traffic originates in Ontario, although some other shippers are present at Vale and Nyssa. Agricultural commodities represent the bulk of the freight tonnage.

The pending merger of the UP and the Southern Pacific Lines (SP) might have an impact on the volumes through Ontario on the UP mainline. The merger would provide new routing options for SP's Oregon and Washington customers. There are no other plans for expansion of the rail freight service within the City of Ontario.

#### ***Railroad Passenger Service***

Amtrak Rail Passenger service was discontinued in 1997. Amtrak now offers bus service as part of its Thruway Motor Coach. The Thruway Motor Coach operates three times a day from Portland to Ontario and twice a day for westbound direction from Ontario to Portland.

There are no plans for the implementation of railroad passenger service nor to expand the Thruway Motor Coach program at this time. The City should work with other communities and the states of Oregon and Idaho to seek reestablishing rail passenger service.

### **7.4.4. Water Transportation Service**

There are no water transportation services within the planning area of Ontario.

#### **7.4.5. Pipeline Service**

Northwest Pipeline Company and Chevron Pipeline Company have pipelines that cross the Snake River and OR 201 at the northeast corner outside of the city limits. Northwest Pipeline Company provides natural gas to local companies that transport natural gas in to the city at various meter stations. Chevron Pipeline Company transports gasoline and other related fluids through pipeline and does not service the City of Ontario directly.

There are no plans to expand the pipeline service within the City of Ontario at this time. However, the city should encourage the use of the pipelines to reduce truck traffic through the city.

**SECTION 8.0**  
**FINANCE PLAN**

## **Section 8.0 Finance Plan**

### **8.1. TRANSPORTATION IMPROVEMENT REVENUE NEEDS**

The Transportation Planning Rule requires Transportation System Plans to evaluate the funding environment for recommended improvements. This evaluation must include a listing of all recommended improvements, estimated costs to implement those improvements, a review of potential funding mechanisms, and an analysis of existing sources' ability to fund proposed transportation improvement projects. Ontario's TSP identifies nearly \$42 in 42 specific projects over the next 20 years. This section of the TSP provides an overview of Ontario's revenue outlook and a review of some funding and financing options that may be available to the City of Ontario to fund the improvements.

Pressures from increasing growth throughout much of Oregon have created a disparity between needed projects and available funding. Ontario will need to work with Malheur County and ODOT to finance the potential new transportation projects over the 20-year planning horizon. The actual timing of these projects will be determined by the rate of population and employment growth actually experienced by the community. This TSP assumes Ontario will grow at a rate comparable to past growth, consistent with the county-wide growth forecast. If population growth exceeds this rate, the improvements may need to be accelerated. Slower than expected growth will relax the improvement schedule.

### **8.2. HISTORICAL STREET IMPROVEMENT FUNDING SOURCES**

In Oregon, state, county, and city jurisdictions work together to coordinate transportation improvements. Table 8-1 shows the distribution of road revenues for the different levels of government within the state by jurisdiction level. Although these numbers were collected and tallied in 1991, ODOT estimates that these figures accurately represent the current revenue structure for transportation-related needs.

At the state level, nearly half (48 percent in Fiscal Year 1991) of all road-related revenues are attributable to the State Highway Fund (State Road Trust), whose sources of revenue include fuel taxes, weight-mile taxes on trucks, and vehicle registration fees. As shown in the table, the state road trust is a considerable source of revenue for all levels of government. Federal sources (generally the Federal Highway Trust account and Federal Forest revenues) comprise another 30 percent of all road-related revenue. The remaining sources of road-related revenues are generated locally, including property taxes, LIDs, bonds, traffic impact fees, road user taxes, general fund transfers, receipts from other local governments, and other sources.

As a state, Oregon generates 94 percent of its highway revenues from user fees, compared to an average of 78 percent among all states. This fee system, including fuel taxes, weight distance charges, and registration fees, is regarded as equitable because it places the greatest financial burden upon those who create the greatest need for road maintenance and improvements. Unlike

many states that have indexed user fees to inflation, Oregon has static road-revenue sources. For example, rather than assessing fuel taxes as a *percentage* of price per gallon, Oregon’s fuel tax is a fixed amount (currently 24 cents) per gallon.

**Table 8-1. Sources of Road Revenues by Jurisdiction Level**

Revenue Source	Jurisdiction Level			All Funds
	State	County	City	
State Road Trust	58%	38%	41%	48%
Local	0%	22%	55%	17%
Federal Road	34%	40%	4%	30%
Other	9%	0%	0%	4%
Total	100%	100%	100%	100%

*Source: ODOT 1993 Oregon Road Finance Study.*

### **Historical Revenues and Expenditures in the City of Ontario**

Revenues and expenditures for the City of Ontario’s Street Fund are shown in Table 8-2 and Table 8-3. The Street Fund was established in the 1998-99 budget year. In prior years, street fund revenues and expenditures were captured in the utility fund. Traditional sources of revenue available for street operations and maintenance are comprised primarily of the State Highway Fund and the motel occupancy tax. The previous years’ revenue streams from these larger revenue sources were identified from the reporting of the Utility Fund.

As shown in Table 8-3, revenue from the State Highway Fund (referred to in this fund as the State Agency Fund) provided the majority of revenues available for street operations purposes. The motel occupancy tax has also provided stable revenues of approximately \$230,000 to \$250,000 annually.

As shown in Table 8-3 most of the Street Fund expenditures are for maintenance, with spending disaggregated to the following broad categories: street maintenance, street lighting, street sweeping, and other street department. The largest categories have historically been street maintenance and materials and services relating to “other street department” expenditures. Capital outlay expenditures have been limited in recent years, but have larger amounts budgeted in the 1996-97 (\$238,000 plus \$15,000 under other street expenditures) and 1997-98 (\$136,400) budget years.

**Table 8-2  
City of Ontario Street Fund Revenues**

	<b>1994-1995</b>	<b>1995-1996</b>	<b>1996-1997</b>	<b>1997-1998</b>
	<b>Actual</b>	<b>Actual</b>	<b>Budget</b>	<b>Budget</b>
Cash on Hand				\$179,579
<b>Revenues</b>				
Water License				\$12,000
Motel Occupancy	\$233,130	\$229,334	\$246,000	\$250,000
Sewer License				\$20,507
Storm Sewer Lic				\$1,237
Interest on Deposits				\$3,250
State Agency Fund	\$494,416	\$512,073	\$465,000	\$497,000
SDC Reimbursement				\$3,000
SDC Future Development				\$3,000
Misc Collections				\$500
	\$727,546	\$741,407	\$711,000	\$790,494

*Source: The City of Ontario*

**Table 8-3. City of Ontario Street Fund Expenditures**

	<b>1994-1995</b>	<b>1995-1996</b>	<b>1996-1997</b>	<b>1997-1998</b>
	<b>Actual</b>	<b>Actual</b>	<b>Budget</b>	<b>Budget</b>
<b>Street Maintenance</b>				
Payroll-Related Expenses	\$148,709	\$134,556	\$154,591	\$157,899
Materials and Supplies	\$135,439	\$145,953	\$112,636	\$129,636
Capital Outlay			\$238,065	\$136,398
Street Lighting	\$81,542	\$76,601	\$80,000	\$80,000
<b>Street Sweeping</b>				
Payroll-Related Expenses	\$42,773	\$43,493	\$46,663	\$47,891
Materials and Supplies	\$29,148	\$38,669	\$40,555	\$45,355
<b>Other Street Department</b>				
Payroll-Related Expenses		\$13,806	\$16,750	\$4,750
Materials and Supplies	\$207,973	\$751,828	\$336,902	\$318,502
Capital Outlay			\$15,000	
Operating Contingency			\$420,602	\$51,375
	\$645,584	\$1,204,905	\$1,461,764	\$971,806

*Source: City of Ontario*

### 8.3. TRANSPORTATION REVENUE OUTLOOK

ODOT's policy section recommends certain assumptions in the preparation of transportation plans. In its *Financial Assumptions* document prepared in May 1998, ODOT projected the revenue of the State Highway Fund through year 2020. The estimates are based on not only the political climate, but also the economic structure and conditions, population and demographics, and patterns of land use. The latter is particularly important for state-imposed fees because of the goals in place under Oregon's Transportation Planning Rule (TPR) requiring a 10-percent reduction in per-capita vehicle miles of travel (VMT) in Metropolitan Planning Organizations (MPO) areas by year 2015, and a 20-percent reduction by year 2025. This requirement will affect the 20-year revenue forecast from the fuel tax. ODOT recommends the following assumptions:

- Fuel tax increases of one cent per gallon per year (beginning in year 2002), with an additional one cent per gallon every fourth year;
- Vehicle registration fees would be increased by \$10 per year in 2002, and by \$15 per year in year 2012;
- Revenues will fall halfway between the revenue-level generated without TPR and the revenue level if TPR goals were fully met;
- Revenues will be shared among the state, counties, and cities on a "50-30-20 percent" basis rather than the previous "60.05-24.38-15.17 percent" basis; and
- Inflation occurs at an average annual rate of 3.6 percent (as assumed by ODOT).

Figure 8-1 shows the forecast in both current-dollar and inflation-deflated constant (1998) dollars. As highlighted by the constant-dollar data, the highway fund is expected to grow slower than inflation early in the planning horizon until fuel-tax and vehicle-registration fee increases occur in year 2002, increasing to a rate somewhat faster than inflation through year 2015, continuing a slight decline through the remainder of the planning horizon.

As the State Highway Fund is expected to remain a significant source of funding for Ontario, the City is highly susceptible to changes in the State Highway Fund. As discussed earlier, funds from the State Highway Fund provide a large proportion of the revenues available to the City of Ontario's Street Fund.

To analyze the City's ability to fund the recommended improvements from current sources, the following assumptions were applied:

- ODOT State Highway Fund assumptions as outlined above;
- The State Highway Fund will continue to account for the majority of the City's Street Fund;
- Interest and other local sources continue to provide stable revenue streams; and
- The proportion of revenues available for capital expenditures for street improvements will remain a stable proportion of the state tax resources.

**Figure 8-1. State Highway Fund (in Millions of Dollars)**

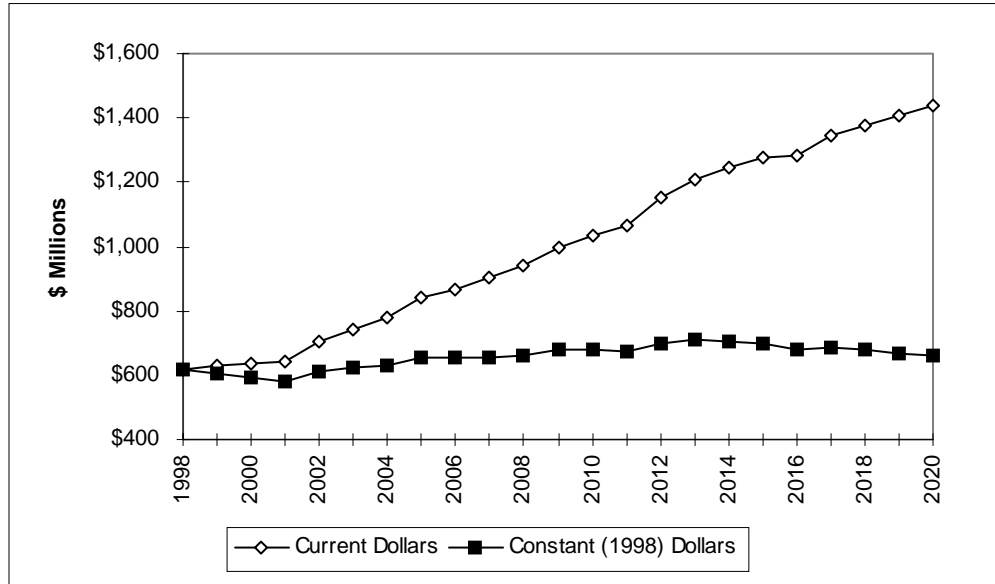

Source: ODOT Financial Assumptions.

These assumptions were applied to the estimated level of the State Highway Fund resources, as recommended by ODOT. Based on this analysis, resources available to the Ontario for all operations, maintenance, and capital outlay purposes are estimated at approximately \$460,000 and \$566,000 annually (in current 1998 dollars), as shown in Table 8-4. Using historical and estimated budget information for 1994-95, 1995-96, 1996-97, and 1997-98, this analysis assumes that approximately 80 percent of the resources from the State Highway Fund are used for operations and maintenance, while 20 percent are available for capital improvements.

The amount actually received from the State Highway Fund will depend on a number of factors, including:

- the actual revenue generated by state gasoline taxes, vehicle registration fees, and other sources; and
- the population growth in Ontario (since the distribution of State Highway Funds is based on an allocation formula which includes population).

Based on the amount of resources historically available to fund capital improvements, this analysis suggests that the City of Ontario will have between \$91,000 and \$112,000 available annually for capital improvements. However, some members of the City of Ontario staff have expressed concerns that current maintenance needs are not being fully addressed. The diversion of additional resources to address maintenance deficiencies may affect the resources available for capital improvements.



**Table 8-4. Estimated resources available to City of Ontario from State Highway Fund, 1998 Dollars**

<b>Year</b>	<b>Total Estimated Resources from State Highway Fund</b>	<b>Estimated Funds Available for Capital Outlay</b>
1999	\$482,600	\$95,500
2000	\$471,600	\$93,300
2001	\$460,800	\$91,200
2002	\$488,200	\$96,600
2003	\$494,800	\$97,900
2004	\$501,400	\$99,200
2005	\$523,300	\$103,600
2006	\$519,000	\$102,700
2007	\$522,000	\$103,300
2008	\$523,900	\$103,700
2009	\$539,100	\$106,700
2010	\$538,700	\$106,600
2011	\$536,400	\$106,200
2012	\$557,500	\$110,300
2013	\$566,500	\$112,100
2014	\$561,800	\$111,200
2015	\$557,000	\$110,200
2016	\$541,100	\$107,100
2017	\$545,900	\$108,100
2018	\$539,400	\$106,800
2019	\$532,800	\$105,500
2020	\$525,800	\$104,100

#### **8.4. REVENUE SOURCES AND FINANCING OPTIONS**

Several possible funding sources exist to implement the recommended transportation improvements. The following pages describe the funding sources that may be available.

##### **Local Sources**

The following options are available on the local level to raise funds for transportation improvements:

##### Local Option Gasoline Tax

Revenues raised from a local option gasoline tax could be used by the City to fund recommended transportation improvements. The monies collected from a local gas tax could generate enough monies to at least generate local matching money for grants.

## Property Taxes

Local property taxes can be used to fund transportation system improvements. A specific allocation of property taxes to transportation improvements could be identified or set at a fixed and predictable level to provide a longer-term stable and predictable source of revenue. This would be important in implementing larger, longer-term projects with a high capital cost. Voter approval is necessary for the use of property taxes to fund roadway improvements and the uncertainty of this approval affects the attractiveness of this revenue choice. Another major disadvantage of using property taxes to support transportation improvements includes the inequity of this tax when compared with the users of the system (a user tax such as the tax on gasoline is more equitable in that persons who drive and use the street system pay for it rather than persons who own property). Additionally, the use of property taxes to fund transportation improvements would be restricted by the limitations of Measure 5.

## Debt Funding

The City could issue municipal bonds to finance improvements. This approach would spread the cost of improvements over the life of the bonds and lower the annual expenses during construction years. If revenue bonds are issued, voter approval might not be necessary, but an identified revenue source (i.e., property taxes) would need to be identified to satisfy the bond underwriter. General obligation bonds would require voter approval. Both bonding approaches would be limited by the restrictions of Measure 5 and the bonding capacity of the local agencies.

## System Development Charges

Oregon law enables communities to fund growth-related transportation improvements by imposing system development charges. These charges apply to newly developed property and can be used to recover the costs of past or future roadway improvement projects necessitated by growth. They may not be used to fund transportation improvements to serve existing residents. Therefore, while it is relatively easy to estimate the system development charges which would be needed to build improvements associated with growth, these charges will not be sufficient to meet all of the infrastructure needs identified in this plan.

The City of Ontario has an SDC implementation plan currently before the governing body for consideration and adoption to address capacity issues; and, is working on establishing a transportation fee, assessable to individual properties, to address maintenance of transportation facilities.

System development charges (SDCs) are considered by many to be an equitable method of funding as they provide for many of the improvements needed because of growth in the community. On the other hand, growth in non-local traffic or traffic attributable to existing residents may also fuel the need for improvements which the system development charges are used to fund. Revenue from SDCs is generally not stable or predictable over time as it is received only when development

occurs. During times of economic downturn, this revenue source may taper off entirely. This makes it difficult to rely on this source of funds for larger, multi-phased or multi-year projects.

It is required by state law for SDCs to finance those transportation improvements that are tied to local growth needs and, if the anticipated growth does not occur when expected or at all, both the improvement costs and the development charge revenue will not be needed.

### Local Improvement Districts

Local improvement districts, known as LIDs, could be formed to finance public transportation improvements. LIDs may be formed by either the City or property owners. Their use and benefit are usually restricted to a specific area. The cost of a project with an LID in place is distributed to each property owner according to the benefit that property receives. With transportation improvements, that benefit may be measured by trips generated by each property. Or, in the example of a sidewalk improvement, the cost could be equitably divided by lineal feet of sidewalk along property frontages. The cost distributed becomes an assessment or lien against the property. It can be paid in cash or through assessment financing.

### **Non-Local Funding Sources**

#### State Gasoline Tax

Gas tax revenues received from the state are used by all counties and cities to fund road construction and maintenance. The revenue share to cities is divided through an allocation formula related to population. The state gas tax received by the City of Ontario will not sufficiently fund the improvements identified in the TSP and may not even cover maintenance needs.

#### Grants and Loans

Most grant and loan programs available through the state are related to economic development and not specifically for construction of new streets. Programs such as the Oregon Special Public Works Fund provides grant and load assistance for construction of public infrastructure that support commercial and industrial development that results in permanent job creation or retention. Another grant program is the Immediate Opportunity Fund (IOP). Again, this grant is tied to local and regional economic development efforts.

### **ODOT Funding Options**

The State of Oregon provides funding for all highway-related transportation projects through the Statewide Transportation Improvement Program (STIP) administered by ODOT. The STIP outlines the schedule for ODOT projects throughout the state. Projects within the STIP are identified for a

four-year funding cycle. In developing this funding program, ODOT must verify that the identified projects comply with the OHP, ODOT modal plans, corridor plans, local comprehensive plans, and TEA-21 planning requirements. The STIP must fulfill TEA-21 planning requirements. Specific transportation projects are prioritized based on a review of the TEA-21 planning requirements and the different state plans. ODOT consults with local jurisdictions before highway related projects are added to the STIP.

ODOT has the option of making some highway improvements as part of their ongoing maintenance program.

# **APPENDIX**

**Appendix A**  
**ODOT Bridge Inventory and Ratings**

Bridge	Maintenance Responsibility	FACILITY_ITEM_7	FEAT_INTER_ITEM_6A	dbo_Structure_Type_name	post	SUFF	origin_date	SR
045R01	City or Municipal Highway Agency	HYLINE B499	HIGHLINE CANAL	Tee Beam	0	NA	1/1/1978	95.9
08395	State Highway Agency	I-84 (HWY 006)	DORK CANAL	Culvert	374.75	NA	1/1/1960	83
08396A	State Highway Agency	I-84 (HWY 006)	DRAINAGE DITCH	Culvert	375.02	NA	1/1/1960	83
08397E	State Highway Agency	I-84 (HWY 006) EB	UPRR	Stringer/Multi-beam or Girder	375.8	NotDef	1/1/1960	85.6
08397W	State Highway Agency	I-84 (HWY 006) WB	UPRR	Stringer/Multi-beam or Girder	375.8	NotDef	1/1/1960	85.6
18097	State Highway Agency	US 30 (HWY 455SP)	IDAHO AVENUE INTERCHANGE	Box Beam or Girders - Multiple	27.73	NotDef	1/1/1998	100
18724	County Highway Agency	SW 18TH AVE	UPRR	Stringer/Multi-beam or Girder	0	NotDef	2/14/2003	99.9
45R08	City or Municipal Highway Agency	GROVE ROAD	LOWER CANAL	Other	0	NA	1/1/1960	91.7
08398E	State Highway Agency	I-84 (HWY 006) EB	GRIGG ROAD	Stringer/Multi-beam or Girder	376	NotDef	1/1/1960	94.8
08398W	State Highway Agency	I-84 (HWY 006) WB	GRIGG ROAD	Stringer/Multi-beam or Girder	376	NotDef	1/1/1960	94.8
08400	State Highway Agency	SE 5TH AVENUE	I-84 (HWY 006)	Stringer/Multi-beam or Girder	376.98	FunObs	1/1/1960	53.5

**Appendix B**

Intersection: I-84 WB Ramps/Hwy 201

PM Peak Hour Turning Movement Volumes

Count Date: September 2, 2004

Time	<u>SB</u>				<u>WB</u>				<u>NB</u>				<u>EB</u>				Total
	SBR	SBT	SBL	Trucks	WBR	WBT	WBL	Trucks	NBR	NBT	NBL	Trucks	EBR	EBT	EBL	Trucks	
<u>15 Minute Totals</u>																	
4:00 - 4:15 PM	0	0	0	0	3	50	0	3	17	0	18	2	0	54	5	3	147
4:15 - 4:30 PM	0	0	0	0	0	52	0	6	23	0	19	4	0	40	7	6	141
4:30 - 4:45 PM	0	0	0	0	2	44	0	2	13	0	17	2	0	68	10	3	154
4:45 - 5:00 PM	0	0	0	0	0	50	0	1	10	0	20	1	0	54	7	0	141
5:00 - 5:15 PM	0	0	0	0	2	44	0	2	21	0	17	7	0	102	5	1	191
5:15 - 5:30 PM	0	0	0	0	0	68	0	0	24	0	29	4	0	70	9	2	200
5:30 - 5:45 PM	0	0	0	0	1	56	0	2	25	0	17	3	0	67	9	1	175
5:45 - 6:00 PM	0	0	0	0	0	59	0	1	17	0	21	4	0	46	12	2	155
<u>Hourly Total by 15 minutes</u>																	
4:00 - 5:00 PM	0	0	0	0	5	196	0	12	63	0	74	9	0	216	29	12	583
4:15 - 5:15 PM	0	0	0	0	4	190	0	11	67	0	73	14	0	264	29	10	627
4:30 - 5:30 PM	0	0	0	0	4	206	0	5	68	0	83	14	0	294	31	6	686
4:45 - 5:45 PM	0	0	0	0	3	218	0	5	80	0	83	15	0	293	30	4	707
5:00 - 6:00 PM	0	0	0	0	3	227	0	5	87	0	84	18	0	285	35	6	721
Peak Hour 5:00 - 6:00 PM	0	0	0	0	3	227	0	5	87	0	84	18	0	285	35	6	721
Peak Hour Factor	0.00				0.85				0.81				0.75			0.90	
Percent Trucks	0%				2%				11%				2%				

**Appendix B**

Intersection: I-84 EB Ramps/Hwy 201

PM Peak Hour Turning Movement Volumes

Count Date: September 2, 2004

Time	<u>SB</u>				<u>WB</u>				<u>NB</u>				<u>EB</u>				Total
	SBR	SBT	SBL	Trucks	WBR	WBT	WBL	Trucks	NBR	NBT	NBL	Trucks	EBR	EBT	EBL	Trucks	
<u>15 Minute Totals</u>																	
4:00 - 4:15 PM	23	0	0	1	0	61	9	4	0	0	0	0	21	66	0	5	180
4:15 - 4:30 PM	10	0	2	1	0	72	3	8	0	0	0	0	23	52	0	12	162
4:30 - 4:45 PM	29	0	1	4	0	54	10	2	0	0	0	0	25	74	0	6	193
4:45 - 5:00 PM	12	0	0	1	0	58	12	2	0	0	0	0	20	64	0	1	166
5:00 - 5:15 PM	18	0	1	1	0	50	15	5	0	0	0	0	19	105	0	5	208
5:15 - 5:30 PM	13	0	0	0	0	83	17	6	0	0	0	0	20	88	0	5	221
5:30 - 5:45 PM	17	0	1	1	0	60	13	4	0	0	0	0	19	72	0	4	182
5:45 - 6:00 PM	13	0	0	1	0	78	11	4	0	0	0	0	25	51	0	9	178
<u>Hourly Total by 15 minutes</u>																	
4:00 - 5:00 PM	74	0	3	7	0	245	34	16	0	0	0	0	89	256	0	24	701
4:15 - 5:15 PM	69	0	4	7	0	234	40	17	0	0	0	0	87	295	0	24	729
4:30 - 5:30 PM	72	0	2	6	0	245	54	15	0	0	0	0	84	331	0	17	788
4:45 - 5:45 PM	60	0	2	3	0	251	57	17	0	0	0	0	78	329	0	15	777
5:00 - 6:00 PM	61	0	2	3	0	271	56	19	0	0	0	0	83	316	0	23	789
Peak Hour 5:00 - 6:00 PM	61	0	2	3	0	271	56	19	0	0	0	0	83	316	0	23	789
Peak Hour Factor		0.83				0.82				0.00				0.80			0.89
Percent Trucks		5%				6%				0%				6%			



**Appendix B**

Intersection: Oregon Street/Washington Avenue  
 PM Peak Hour Turning Movement Volumes

Count Date: September 8, 2004

Time	<u>SB</u>				<u>WB</u>				<u>NB</u>				<u>EB</u>				Total
	SBR	SBT	SBL	Trucks	WBR	WBT	WBL	Trucks	NBR	NBT	NBL	Trucks	EBR	EBT	EBL	Trucks	
<u>15 Minute Totals</u>																	
4:00 - 4:15 PM	44	27	0	8	0	0	0	0	0	34	8	1	12	0	51	8	176
4:15 - 4:30 PM	50	39	0	11	0	0	0	0	0	28	10	1	6	0	62	9	195
4:30 - 4:45 PM	51	30	0	8	0	0	0	0	0	40	14	0	7	0	60	9	202
4:45 - 5:00 PM	41	17	0	4	0	0	0	0	0	29	17	0	8	0	67	5	179
5:00 - 5:15 PM	48	35	0	2	0	0	0	0	0	47	8	0	8	0	81	16	227
5:15 - 5:30 PM	53	24	0	6	0	0	0	0	0	42	12	1	8	0	56	3	195
5:30 - 5:45 PM	49	29	0	6	0	0	0	0	0	37	6	1	11	0	69	6	201
5:45 - 6:00 PM	42	20	0	3	0	0	0	0	0	26	9	0	10	0	45	12	152
<u>Hourly Total by 15 minutes</u>																	
4:00 - 5:00 PM	186	113	0	31	0	0	0	0	0	131	49	2	33	0	240	31	752
4:15 - 5:15 PM	190	121	0	25	0	0	0	0	0	144	49	1	29	0	270	39	803
4:30 - 5:30 PM	193	106	0	20	0	0	0	0	0	158	51	1	31	0	264	33	803
4:45 - 5:45 PM	191	105	0	18	0	0	0	0	0	155	43	2	35	0	273	30	802
5:00 - 6:00 PM	192	108	0	17	0	0	0	0	0	152	35	2	37	0	251	37	775
Peak Hour 4:15 - 5:15 PM	190	121	0	25	0	0	0	0	0	144	49	1	29	0	270	39	803
Peak Hour Factor		0.87				0.00				0.88				0.84			0.88
Percent Trucks		8%				0%				1%				13%			

**Appendix B**

Intersection: West Idaho Avenue/Verde Drive

PM Peak Hour Turning Movement Volumes

Count Date: September 9, 2004

Time	<u>SB</u>				<u>WB</u>				<u>NB</u>				<u>EB</u>				Total
	SBR	SBT	SBL	Trucks	WBR	WBT	WBL	Trucks	NBR	NBT	NBL	Trucks	EBR	EBT	EBL	Trucks	
<u>15 Minute Totals</u>																	
4:00 - 4:15 PM	5	26	18	0	19	22	11	1	7	32	4	0	4	20	2	0	170
4:15 - 4:30 PM	2	34	13	0	11	20	10	0	2	35	3	1	3	17	2	1	152
4:30 - 4:45 PM	5	39	18	1	10	20	16	0	6	29	0	0	8	13	5	0	169
4:45 - 5:00 PM	4	32	17	0	16	25	15	0	4	34	3	0	1	22	4	0	177
5:00 - 5:15 PM	2	27	13	2	23	16	7	2	9	39	6	0	2	18	6	0	168
5:15 - 5:30 PM	2	33	15	1	31	24	13	0	4	46	5	1	5	24	6	0	208
5:30 - 5:45 PM	5	33	11	0	22	29	15	1	4	37	3	1	5	10	4	0	178
5:45 - 6:00 PM	2	26	23	1	10	19	14	0	6	28	4	0	2	17	2	0	153
<u>Hourly Total by 15 minutes</u>																	
4:00 - 5:00 PM	16	131	66	1	56	87	52	1	19	130	10	1	16	72	13	1	668
4:15 - 5:15 PM	13	132	61	3	60	81	48	2	21	137	12	1	14	70	17	1	666
4:30 - 5:30 PM	13	131	63	4	80	85	51	2	23	148	14	1	16	77	21	0	722
4:45 - 5:45 PM	13	125	56	3	92	94	50	3	21	156	17	2	13	74	20	0	731
5:00 - 6:00 PM	11	119	62	4	86	88	49	3	23	150	18	2	14	69	18	0	707
Peak Hour 4:45 - 5:45 PM	13	125	56	3	92	94	50	3	21	156	17	2	13	74	20	0	731
Peak Hour Factor		0.92				0.87				0.88				0.76			0.88
Percent Trucks		2%				1%				1%				0%			

**Appendix B**

Intersection: West Idaho Avenue/SW 9th Street

PM Peak Hour Turning Movement Volumes

Count Date: August 25, 2004

Time	<u>SB</u>				<u>WB</u>				<u>NB</u>				<u>EB</u>				Total
	SBR	SBT	SBL	Trucks	WBR	WBT	WBL	Trucks	NBR	NBT	NBL	Trucks	EBR	EBT	EBL	Trucks	
<u>15 Minute Totals</u>																	
4:00 - 4:15 PM	3	19	11	0	2	52	40	1	24	26	5	1	3	40	1	0	226
4:15 - 4:30 PM	2	23	9	0	2	39	33	0	22	22	8	0	3	27	4	0	194
4:30 - 4:45 PM	3	8	9	0	6	39	31	0	35	18	8	0	4	26	3	0	190
4:45 - 5:00 PM	2	15	9	1	5	49	19	0	20	22	4	0	10	36	5	0	196
5:00 - 5:15 PM	5	10	8	0	8	48	24	0	19	26	5	0	7	26	2	1	188
5:15 - 5:30 PM	4	15	11	0	8	51	14	0	19	33	8	0	4	36	6	0	209
5:30 - 5:45 PM	5	19	5	0	7	40	17	0	21	19	5	1	6	39	6	1	189
5:45 - 6:00 PM	6	19	8	0	8	34	27	1	17	20	8	0	10	35	5	0	197
<u>Hourly Total by 15 minutes</u>																	
4:00 - 5:00 PM	10	65	38	1	15	179	123	1	101	88	25	1	20	129	13	0	806
4:15 - 5:15 PM	12	56	35	1	21	175	107	0	96	88	25	0	24	115	14	1	768
4:30 - 5:30 PM	14	48	37	1	27	187	88	0	93	99	25	0	25	124	16	1	783
4:45 - 5:45 PM	16	59	33	1	28	188	74	0	79	100	22	1	27	137	19	2	782
5:00 - 6:00 PM	20	63	32	0	31	173	82	1	76	98	26	1	27	136	19	2	783
Peak Hour 4:00 - 5:00 PM	10	65	38	1	15	179	123	1	101	88	25	1	20	129	13	0	806
Peak Hour Factor		0.83				0.84				0.88				0.79			0.89
Percent Trucks		1%				0%				0%				0%			

**Appendix B**

Intersection: West Idaho Avenue/SW 4th Street  
 PM Peak Hour Turning Movement Volumes

Count Date: August 26, 2004

Time	<u>SB</u>				<u>WB</u>				<u>NB</u>				<u>EB</u>				Total
	SBR	SBT	SBL	Trucks	WBR	WBT	WBL	Trucks	NBR	NBT	NBL	Trucks	EBR	EBT	EBL	Trucks	
<u>15 Minute Totals</u>																	
4:00 - 4:15 PM	3	2	1	0	1	79	54	1	26	13	5	0	8	53	1	0	246
4:15 - 4:30 PM	0	4	1	0	2	71	40	1	20	8	2	2	6	73	1	0	228
4:30 - 4:45 PM	0	8	2	0	2	59	38	1	32	9	2	1	9	62	1	1	224
4:45 - 5:00 PM	1	5	1	0	2	74	48	5	24	9	3	0	7	73	0	2	247
5:00 - 5:15 PM	4	3	4	0	2	71	36	0	40	8	6	0	6	67	2	1	249
5:15 - 5:30 PM	0	2	1	0	0	86	41	1	28	5	4	0	5	52	1	0	225
5:30 - 5:45 PM	0	7	1	0	0	67	34	0	27	11	2	1	4	60	0	1	213
5:45 - 6:00 PM	0	15	1	0	1	53	44	0	29	14	2	0	6	58	1	0	224
<u>Hourly Total by 15 minutes</u>																	
4:00 - 5:00 PM	4	19	5	0	7	283	180	8	102	39	12	3	30	261	3	3	945
4:15 - 5:15 PM	5	20	8	0	8	275	162	7	116	34	13	3	28	275	4	4	948
4:30 - 5:30 PM	5	18	8	0	6	290	163	7	124	31	15	1	27	254	4	4	945
4:45 - 5:45 PM	5	17	7	0	4	298	159	6	119	33	15	1	22	252	3	4	934
5:00 - 6:00 PM	4	27	7	0	3	277	155	1	124	38	14	1	21	237	4	2	911
Peak Hour 4:15 - 5:15 PM	5	20	8	0	8	275	162	7	116	34	13	3	28	275	4	4	948
Peak Hour Factor		0.75				0.90				0.75				0.96			0.95
Percent Trucks		0%				2%				2%				1%			

**Appendix B**

Intersection: West Idaho Avenue/SW 2nd Street

PM Peak Hour Turning Movement Volumes

Count Date: September 8, 2004

Time	<u>SB</u>				<u>WB</u>				<u>NB</u>				<u>EB</u>				Total
	SBR	SBT	SBL	Trucks	WBR	WBT	WBL	Trucks	NBR	NBT	NBL	Trucks	EBR	EBT	EBL	Trucks	
<u>15 Minute Totals</u>																	
4:00 - 4:15 PM	2	1	2	0	3	126	52	5	39	4	1	1	3	90	3	1	326
4:15 - 4:30 PM	4	1	3	0	0	102	43	4	29	4	0	1	7	79	2	1	274
4:30 - 4:45 PM	1	0	2	1	4	89	27	0	28	6	2	1	3	83	2	0	247
4:45 - 5:00 PM	6	2	1	0	2	113	36	3	42	5	4	1	6	109	2	0	328
5:00 - 5:15 PM	3	4	2	0	1	110	33	1	42	1	3	1	3	101	1	1	304
5:15 - 5:30 PM	7	0	4	1	3	129	34	2	32	1	1	2	4	88	5	0	308
5:30 - 5:45 PM	6	1	1	1	5	97	25	3	27	2	1	2	1	78	1	0	245
5:45 - 6:00 PM	2	2	0	0	4	87	34	3	18	3	1	0	1	71	2	0	225
<u>Hourly Total by 15 minutes</u>																	
4:00 - 5:00 PM	13	4	8	1	9	430	158	12	138	19	7	4	19	361	9	2	1,175
4:15 - 5:15 PM	14	7	8	1	7	414	139	8	141	16	9	4	19	372	7	2	1,153
4:30 - 5:30 PM	17	6	9	2	10	441	130	6	144	13	10	5	16	381	10	1	1,187
4:45 - 5:45 PM	22	7	8	2	11	449	128	9	143	9	9	6	14	376	9	1	1,185
5:00 - 6:00 PM	18	7	7	2	13	423	126	9	119	7	6	5	9	338	9	1	1,082
Peak Hour 4:30 - 5:30 PM	17	6	9	2	10	441	130	6	144	13	10	5	16	381	10	1	1,187
Peak Hour Factor		0.73				0.88				0.82				0.87			0.90
Percent Trucks		6%				1%				3%				0%			

**Appendix B**

Intersection: West Idaho Avenue/Oregon Street  
 PM Peak Hour Turning Movement Volumes

Count Date: September 8, 2004

Time	<u>SB</u>				<u>WB</u>				<u>NB</u>				<u>EB</u>				Total
	SBR	SBT	SBL	Trucks	WBR	WBT	WBL	Trucks	NBR	NBT	NBL	Trucks	EBR	EBT	EBL	Trucks	
<u>15 Minute Totals</u>																	
4:00 - 4:15 PM	17	18	46	2	42	179	24	9	81	18	3	1	4	132	11	2	575
4:15 - 4:30 PM	17	19	38	1	47	147	32	7	86	19	5	2	7	114	8	2	539
4:30 - 4:45 PM	14	12	49	2	33	131	35	2	95	16	4	1	5	98	25	1	517
4:45 - 5:00 PM	8	12	50	1	21	134	28	4	82	17	4	0	6	161	9	1	532
5:00 - 5:15 PM	10	19	48	1	42	151	20	1	100	24	5	1	4	169	12	3	604
5:15 - 5:30 PM	9	15	46	1	45	160	28	2	79	23	4	2	6	128	10	4	553
5:30 - 5:45 PM	11	17	49	1	33	126	22	2	93	13	0	0	6	112	10	2	492
5:45 - 6:00 PM	10	19	50	1	47	133	22	5	70	9	3	0	6	91	8	1	468
<u>Hourly Total by 15 minutes</u>																	
4:00 - 5:00 PM	56	61	183	6	143	591	119	22	344	70	16	4	22	505	53	6	2,163
4:15 - 5:15 PM	49	62	185	5	143	563	115	14	363	76	18	4	22	542	54	7	2,192
4:30 - 5:30 PM	41	58	193	5	141	576	111	9	356	80	17	4	21	556	56	9	2,206
4:45 - 5:45 PM	38	63	193	4	141	571	98	9	354	77	13	3	22	570	41	10	2,181
5:00 - 6:00 PM	40	70	193	4	167	570	92	10	342	69	12	3	22	500	40	10	2,117
Peak Hour 4:30 - 5:30 PM	41	58	193	5	141	576	111	9	356	80	17	4	21	556	56	9	2,206
Peak Hour Factor		0.95				0.89				0.88				0.86			0.91
Percent Trucks		2%				1%				1%				1%			

**Appendix B**

Intersection: East Idaho Avenue/East 2nd Street  
 PM Peak Hour Turning Movement Volumes

Count Date: September 1, 2004

Time	<u>SB</u>				<u>WB</u>				<u>NB</u>				<u>EB</u>				Total
	SBR	SBT	SBL	Trucks	WBR	WBT	WBL	Trucks	NBR	NBT	NBL	Trucks	EBR	EBT	EBL	Trucks	
<u>15 Minute Totals</u>																	
4:00 - 4:15 PM	27	14	31	2	6	205	10	4	15	7	23	5	13	235	6	5	592
4:15 - 4:30 PM	15	9	21	2	6	222	14	6	12	3	22	2	10	259	10	7	603
4:30 - 4:45 PM	10	7	8	0	5	215	16	5	13	2	22	3	13	232	7	5	550
4:45 - 5:00 PM	9	8	12	0	7	182	10	2	19	3	24	1	18	236	3	4	531
5:00 - 5:15 PM	13	9	17	2	2	212	12	4	26	3	14	1	17	321	7	2	653
5:15 - 5:30 PM	10	2	13	1	2	196	5	2	16	2	21	1	18	257	9	2	551
5:30 - 5:45 PM	7	5	12	0	5	183	6	4	12	0	26	1	12	226	8	2	502
5:45 - 6:00 PM	4	1	13	0	4	166	6	1	15	0	19	1	9	219	9	1	465
<u>Hourly Total by 15 minutes</u>																	
4:00 - 5:00 PM	61	38	72	4	24	824	50	17	59	15	91	11	54	962	26	21	2,276
4:15 - 5:15 PM	47	33	58	4	20	831	52	17	70	11	82	7	58	1,048	27	18	2,337
4:30 - 5:30 PM	42	26	50	3	16	805	43	13	74	10	81	6	66	1,046	26	13	2,285
4:45 - 5:45 PM	39	24	54	3	16	773	33	12	73	8	85	4	65	1,040	27	10	2,237
5:00 - 6:00 PM	34	17	55	3	13	757	29	11	69	5	80	4	56	1,023	33	7	2,171
Peak Hour 4:15 - 5:15 PM	47	33	58	4	20	831	52	17	70	11	82	7	58	1,048	27	18	2,337
Peak Hour Factor		0.77				0.93				0.89				0.82			0.89
Percent Trucks		3%				2%				4%				2%			

**Appendix B**

Intersection: East Idaho Avenue/East Lane

PM Peak Hour Turning Movement Volumes

Count Date: September 1, 2004

Time	<u>SB</u>				<u>WB</u>				<u>NB</u>				<u>EB</u>				Total
	SBR	SBT	SBL	Trucks	WBR	WBT	WBL	Trucks	NBR	NBT	NBL	Trucks	EBR	EBT	EBL	Trucks	
<u>15 Minute Totals</u>																	
4:00 - 4:15 PM	25	25	55	1	9	177	64	9	39	26	18	3	13	179	65	6	695
4:15 - 4:30 PM	26	15	53	8	9	184	62	7	51	12	20	0	17	157	71	8	677
4:30 - 4:45 PM	29	14	51	0	7	151	55	4	58	29	26	1	9	142	44	3	615
4:45 - 5:00 PM	35	13	57	1	9	165	39	3	47	27	31	1	14	141	69	4	647
5:00 - 5:15 PM	22	10	44	0	7	154	53	4	86	29	20	0	10	214	68	1	717
5:15 - 5:30 PM	23	20	55	0	11	138	34	3	46	13	24	1	20	145	57	1	586
5:30 - 5:45 PM	33	16	56	0	9	152	45	4	39	19	12	2	5	152	60	3	598
5:45 - 6:00 PM	39	19	61	0	12	117	39	2	45	16	22	1	14	132	73	5	589
<u>Hourly Total by 15 minutes</u>																	
4:00 - 5:00 PM	115	67	216	10	34	677	220	23	195	94	95	5	53	619	249	21	2,634
4:15 - 5:15 PM	112	52	205	9	32	654	209	18	242	97	97	2	50	654	252	16	2,656
4:30 - 5:30 PM	109	57	207	1	34	608	181	14	237	98	101	3	53	642	238	9	2,565
4:45 - 5:45 PM	113	59	212	1	36	609	171	14	218	88	87	4	49	652	254	9	2,548
5:00 - 6:00 PM	117	65	216	0	39	561	171	13	216	77	78	4	49	643	258	10	2,490
Peak Hour 4:15 - 5:15 PM	112	52	205	9	32	654	209	18	242	97	97	2	50	654	252	16	2,656
Peak Hour Factor		0.88				0.88				0.81				0.82			0.93
Percent Trucks		2%				2%				0%				2%			



**Appendix B**

Intersection: SW 4th Avenue/Dorian Drive

PM Peak Hour Turning Movement Volumes

Count Date: September 9, 2004

Time	<u>SB</u>				<u>WB</u>				<u>NB</u>				<u>EB</u>				Total
	SBR	SBT	SBL	Trucks	WBR	WBT	WBL	Trucks	NBR	NBT	NBL	Trucks	EBR	EBT	EBL	Trucks	
<u>15 Minute Totals</u>																	
4:00 - 4:15 PM	14	0	18	1	28	104	0	3	0	0	0	0	0	84	10	2	258
4:15 - 4:30 PM	10	0	26	0	16	90	0	0	0	0	0	0	0	83	5	3	230
4:30 - 4:45 PM	6	0	19	1	29	82	0	2	0	0	0	0	0	90	4	0	230
4:45 - 5:00 PM	7	0	23	0	25	81	0	3	0	0	0	0	0	81	4	2	221
5:00 - 5:15 PM	6	0	16	0	28	120	0	2	0	0	0	0	0	94	4	0	268
5:15 - 5:30 PM	11	0	14	0	22	117	0	0	0	0	0	0	0	67	0	0	231
5:30 - 5:45 PM	6	0	17	0	21	86	0	2	0	0	0	0	0	59	4	2	193
5:45 - 6:00 PM	7	0	21	0	17	85	0	1	0	0	0	0	0	59	5	2	194
<u>Hourly Total by 15 minutes</u>																	
4:00 - 5:00 PM	37	0	86	2	98	357	0	8	0	0	0	0	0	338	23	7	939
4:15 - 5:15 PM	29	0	84	1	98	373	0	7	0	0	0	0	0	348	17	5	949
4:30 - 5:30 PM	30	0	72	1	104	400	0	7	0	0	0	0	0	332	12	2	950
4:45 - 5:45 PM	30	0	70	0	96	404	0	7	0	0	0	0	0	301	12	4	913
5:00 - 6:00 PM	30	0	68	0	88	408	0	5	0	0	0	0	0	279	13	4	886
Peak Hour 4:30 - 5:30 PM	30	0	72	1	104	400	0	7	0	0	0	0	0	332	12	2	950
Peak Hour Factor		0.85				0.85				0.00				0.88			0.89
Percent Trucks		1%				1%				0%				1%			

**Appendix B**

Intersection: SW 4th Avenue/Verde Drive  
 PM Peak Hour Turning Movement Volumes

Count Date: September 9, 2004

Time	<u>SB</u>				<u>WB</u>				<u>NB</u>				<u>EB</u>				Total
	SBR	SBT	SBL	Trucks	WBR	WBT	WBL	Trucks	NBR	NBT	NBL	Trucks	EBR	EBT	EBL	Trucks	
<u>15 Minute Totals</u>																	
4:00 - 4:15 PM	23	7	17	0	20	138	10	1	4	6	11	0	0	131	15	1	382
4:15 - 4:30 PM	17	7	23	0	24	102	10	0	6	11	12	0	7	127	13	3	359
4:30 - 4:45 PM	21	16	31	0	23	128	9	4	8	11	16	0	2	130	10	3	405
4:45 - 5:00 PM	19	7	25	0	21	136	8	3	8	9	12	0	4	158	18	4	425
5:00 - 5:15 PM	15	8	20	1	35	172	7	2	2	9	10	0	8	157	19	4	462
5:15 - 5:30 PM	21	9	18	0	23	142	9	1	5	12	9	1	2	108	15	0	373
5:30 - 5:45 PM	16	9	24	1	20	123	13	3	3	9	5	0	1	124	19	4	366
5:45 - 6:00 PM	10	13	15	1	22	107	10	0	2	6	9	0	2	94	13	2	303
<u>Hourly Total by 15 minutes</u>																	
4:00 - 5:00 PM	80	37	96	0	88	504	37	8	26	37	51	0	13	546	56	11	1,571
4:15 - 5:15 PM	72	38	99	1	103	538	34	9	24	40	50	0	21	572	60	14	1,651
4:30 - 5:30 PM	76	40	94	1	102	578	33	10	23	41	47	1	16	553	62	11	1,665
4:45 - 5:45 PM	71	33	87	2	99	573	37	9	18	39	36	1	15	547	71	12	1,626
5:00 - 6:00 PM	62	39	77	3	100	544	39	6	12	36	33	1	13	483	66	10	1,504
Peak Hour 4:30 - 5:30 PM	76	40	94	1	102	578	33	10	23	41	47	1	16	553	62	11	1,665
Peak Hour Factor		0.77				0.83				0.79				0.86			0.90
Percent Trucks		0%				1%				1%				2%			

**Appendix B**

Intersection: SW 4th Avenue/SW 9th Street  
 PM Peak Hour Turning Movement Volumes

Count Date: September 1, 2004

Time	<u>SB</u>				<u>WB</u>				<u>NB</u>				<u>EB</u>				Total
	SBR	SBT	SBL	Trucks	WBR	WBT	WBL	Trucks	NBR	NBT	NBL	Trucks	EBR	EBT	EBL	Trucks	
<u>15 Minute Totals</u>																	
4:00 - 4:15 PM	33	9	18	0	0	164	3	0	5	8	20	0	4	179	17	2	460
4:15 - 4:30 PM	37	7	12	0	0	164	3	2	6	13	13	1	8	200	19	2	482
4:30 - 4:45 PM	35	10	16	0	0	173	2	3	5	7	11	0	3	191	28	3	481
4:45 - 5:00 PM	35	8	11	0	0	161	4	3	6	14	13	0	5	165	21	1	443
5:00 - 5:15 PM	40	11	10	0	0	175	4	1	4	11	24	0	5	181	20	3	485
5:15 - 5:30 PM	38	7	7	0	0	137	1	0	7	6	5	0	4	143	22	1	377
5:30 - 5:45 PM	38	8	6	1	0	143	4	1	4	5	14	0	3	142	25	1	392
5:45 - 6:00 PM	35	5	6	0	0	130	3	2	2	7	4	0	3	158	19	0	372
<u>Hourly Total by 15 minutes</u>																	
4:00 - 5:00 PM	140	34	57	0	0	662	12	8	22	42	57	1	20	735	85	8	1,866
4:15 - 5:15 PM	147	36	49	0	0	673	13	9	21	45	61	1	21	737	88	9	1,891
4:30 - 5:30 PM	148	36	44	0	0	646	11	7	22	38	53	0	17	680	91	8	1,786
4:45 - 5:45 PM	151	34	34	1	0	616	13	5	21	36	56	0	17	631	88	6	1,697
5:00 - 6:00 PM	151	31	29	1	0	585	12	4	17	29	47	0	15	624	86	5	1,626
Peak Hour 4:15 - 5:15 PM	147	36	49	0	0	673	13	9	21	45	61	1	21	737	88	9	1,891
Peak Hour Factor		0.95				0.96				0.81				0.93			0.97
Percent Trucks		0%				1%				1%				1%			

**Appendix B**

Intersection: SW 4th Avenue/SW 4th Street

PM Peak Hour Turning Movement Volumes

Count Date: August 26, 2004

Time	<u>SB</u>				<u>WB</u>				<u>NB</u>				<u>EB</u>				Total
	SBR	SBT	SBL	Trucks	WBR	WBT	WBL	Trucks	NBR	NBT	NBL	Trucks	EBR	EBT	EBL	Trucks	
<u>15 Minute Totals</u>																	
4:00 - 4:15 PM	32	29	3	1	3	95	7	2	13	16	28	0	18	116	18	1	378
4:15 - 4:30 PM	28	20	3	0	0	96	4	1	17	14	22	1	24	148	7	2	383
4:30 - 4:45 PM	20	20	0	0	7	89	5	1	11	13	32	1	13	135	15	2	360
4:45 - 5:00 PM	29	32	3	2	1	100	11	2	13	17	31	0	18	111	9	2	375
5:00 - 5:15 PM	21	28	1	0	1	120	4	2	13	22	32	0	27	146	10	3	425
5:15 - 5:30 PM	18	19	1	0	1	110	5	2	8	18	18	0	24	134	15	1	371
5:30 - 5:45 PM	23	12	2	0	3	82	3	4	9	11	18	1	19	111	10	1	303
5:45 - 6:00 PM	15	25	1	0	1	71	6	1	6	20	15	0	15	120	9	1	304
<u>Hourly Total by 15 minutes</u>																	
4:00 - 5:00 PM	109	101	9	3	11	380	27	6	54	60	113	2	73	510	49	7	1,496
4:15 - 5:15 PM	98	100	7	2	9	405	24	6	54	66	117	2	82	540	41	9	1,543
4:30 - 5:30 PM	88	99	5	2	10	419	25	7	45	70	113	1	82	526	49	8	1,531
4:45 - 5:45 PM	91	91	7	2	6	412	23	10	43	68	99	1	88	502	44	7	1,474
5:00 - 6:00 PM	77	84	5	0	6	383	18	9	36	71	83	1	85	511	44	6	1,403
Peak Hour 4:15 - 5:15 PM	98	100	7	2	9	405	24	6	54	66	117	2	82	540	41	9	1,543
Peak Hour Factor		0.80				0.88				0.88				0.91			0.91
Percent Trucks		1%				1%				1%				1%			

**Appendix B**

Intersection: SW 4th Avenue/SW 2nd Street

PM Peak Hour Turning Movement Volumes

Count Date: August 31, 2004

Time	<u>SB</u>				<u>WB</u>				<u>NB</u>				<u>EB</u>				Total
	SBR	SBT	SBL	Trucks	WBR	WBT	WBL	Trucks	NBR	NBT	NBL	Trucks	EBR	EBT	EBL	Trucks	
<u>15 Minute Totals</u>																	
4:00 - 4:15 PM	52	4	0	3	0	80	2	0	2	4	3	0	3	130	25	4	305
4:15 - 4:30 PM	51	6	0	3	1	49	0	1	1	2	4	0	4	125	40	4	283
4:30 - 4:45 PM	42	2	1	2	3	74	0	1	1	2	1	0	1	127	36	1	290
4:45 - 5:00 PM	49	5	3	1	1	73	0	0	3	2	2	0	1	125	26	2	290
5:00 - 5:15 PM	54	1	1	6	1	80	0	0	1	2	2	0	2	129	25	2	298
5:15 - 5:30 PM	28	2	1	0	0	66	0	0	1	0	1	0	2	121	16	1	238
5:30 - 5:45 PM	35	1	1	1	3	62	1	0	1	1	1	0	3	107	21	4	237
5:45 - 6:00 PM	20	5	1	2	0	70	1	0	4	1	2	0	1	97	18	2	220
<u>Hourly Total by 15 minutes</u>																	
4:00 - 5:00 PM	194	17	4	9	5	276	2	2	7	10	10	0	9	507	127	11	1,168
4:15 - 5:15 PM	196	14	5	12	6	276	0	2	6	8	9	0	8	506	127	9	1,161
4:30 - 5:30 PM	173	10	6	9	5	293	0	1	6	6	6	0	6	502	103	6	1,116
4:45 - 5:45 PM	166	9	6	8	5	281	1	0	6	5	6	0	8	482	88	9	1,063
5:00 - 6:00 PM	137	9	4	9	4	278	2	0	7	4	6	0	8	454	80	9	993
Peak Hour 4:00 - 5:00 PM	194	17	4	9	5	276	2	2	7	10	10	0	9	507	127	11	1,168
Peak Hour Factor		0.94				0.86				0.75				0.95			0.96
Percent Trucks		4%				1%				0%				2%			

**Appendix B**

Intersection: SW 5th Avenue/SW 4th Street

PM Peak Hour Turning Movement Volumes

Count Date: September 2, 2004

Time	<u>SB</u>				<u>WB</u>				<u>NB</u>				<u>EB</u>				Total
	SBR	SBT	SBL	Trucks	WBR	WBT	WBL	Trucks	NBR	NBT	NBL	Trucks	EBR	EBT	EBL	Trucks	
<u>15 Minute Totals</u>																	
4:00 - 4:15 PM	4	36	19	1	24	25	5	0	8	26	10	1	3	20	5	0	185
4:15 - 4:30 PM	2	29	17	1	29	16	9	0	6	40	8	3	5	17	5	2	183
4:30 - 4:45 PM	1	20	36	0	24	24	9	2	10	28	5	1	8	18	4	0	187
4:45 - 5:00 PM	5	20	23	0	26	24	9	1	15	26	7	0	7	16	1	1	179
5:00 - 5:15 PM	5	30	25	0	23	28	10	0	15	35	14	1	10	24	2	0	221
5:15 - 5:30 PM	0	24	28	1	20	18	6	0	5	35	2	0	5	13	2	1	158
5:30 - 5:45 PM	1	24	23	0	19	9	9	0	2	35	5	0	5	17	4	2	153
5:45 - 6:00 PM	1	26	19	2	18	12	6	1	6	16	3	0	1	10	2	0	120
<u>Hourly Total by 15 minutes</u>																	
4:00 - 5:00 PM	12	105	95	2	103	89	32	3	39	120	30	5	23	71	15	3	734
4:15 - 5:15 PM	13	99	101	1	102	92	37	3	46	129	34	5	30	75	12	3	770
4:30 - 5:30 PM	11	94	112	1	93	94	34	3	45	124	28	2	30	71	9	2	745
4:45 - 5:45 PM	11	98	99	1	88	79	34	1	37	131	28	1	27	70	9	4	711
5:00 - 6:00 PM	7	104	95	3	80	67	31	1	28	121	24	1	21	64	10	3	652
Peak Hour 4:15 - 5:15 PM	13	99	101	1	102	92	37	3	46	129	34	5	30	75	12	3	770
Peak Hour Factor		0.89				0.95				0.82				0.81			0.87
Percent Trucks		0%				1%				2%				3%			

### Appendix C: Crash Data Summary By Intersection

Intersection	PDO	Injury	Fatal	Total
1st Ave/2nd St	3	1	0	4
1st Ave/4th St	0	1	0	1
1st Ave/Oregon St	0	1	0	1
2nd Ave/11th St	2	1	0	3
2nd Ave/3rd St	1	0	0	1
2nd Ave/4th St	0	1	0	1
2nd Ave/2nd St	0	1	0	1
3rd Ave/12th St	1	0	0	1
3rd Ave/2nd St	0	0	1	1
3rd Ave/3rd St	1	0	0	1
4th Ave/12th St	1	0	0	1
4th Ave/2nd St	1	0	0	1
4th Ave/9th St	1	0	0	1
4th Ave/Verde Dr	2	0	0	2
5th Ave/1st St	1	0	0	1
5th Ave/2nd St	3	2	0	5
5th Ave/3rd St	0	1	0	1
5th Ave/5th St	1	0	0	1
6th Ave/3rd St	0	1	0	1
8th Ave/11th St	1	0	0	1
Airport Way/Central Dr	1	0	0	1
Alameda Dr/SW 4th Ave	4	4	0	8
Alley/SW 4th Ave	2	0	0	2
Arata Way/Verde Dr	0	1	0	1
Dorian Dr/SW 4th Ave	5	2	0	7
Hillcrest Dr/SW 4th Ave	2	0	0	2
Idaho Ave/13th St	1	0	0	1
Idaho Ave/2nd St	0	1	0	1
Idaho Ave/7th St	1	0	0	1
Idaho Ave/East Lane	18	18	0	36
Idaho Ave/Goodfellow St	7	2	0	9
Idaho Ave/Kendall Rd	2	0	0	2
Idaho Ave/NE 2nd St	3	3	0	6
Idaho Ave/NE 3rd St	2	1	0	3
Idaho Ave/NE 4th St	5	3	0	8
Idaho Ave/NW 10th St	1	0	0	1
Idaho Ave/NW 12th St	1	0	0	1
Idaho Ave/NW 1st St	4	3	0	7
Idaho Ave/NW 2nd St	1	1	0	2

### Appendix C: Crash Data Summary By Intersection

Intersection	PDO	Injury	Fatal	Total
Idaho Ave/NW 5th St	2	0	0	2
Idaho Ave/NW 6th St	0	1	0	1
Idaho Ave/NW 8th St	1	0	0	1
Idaho Ave/NW 9th St	0	1	0	1
Idaho Ave/Oregon St	2	0	0	2
Idaho Ave/SE 1st St	1	0	0	1
Idaho Ave/SE 2nd St	3	2	0	5
Idaho Ave/SE 3rd St	5	1	0	6
Idaho Ave/SE 4th St	4	6	0	10
Idaho Ave/SW 11th St	1	1	0	2
Idaho Ave/SW 13th St	1	1	0	2
Idaho Ave/SW 1st St	2	1	0	3
Idaho Ave/SW 2nd St	1	0	0	1
Idaho Ave/SW 4th St	1	0	0	1
Idaho Ave/SW 9th St	2	1	0	3
Idaho Ave/Alley	0	1	0	1
Idaho Ave/Verde Dr	1	0	0	1
Idaho St/Idaho Ave	1	0	0	1
NE 3rd Ave/NE 2nd St	0	1	0	1
NE 4th Ave/NE 1st St	1	0	0	1
NW 1st Ave/NW 1st St	1	0	0	1
NW 1st Ave/NW 2nd St	0	1	0	1
NW 1st Ave/NW 3rd St	1	0	0	1
NW 2nd Ave/NW 10th St	1	0	0	1
NW 2nd Ave/NW 16th St	1	0	0	1
NW 2nd Ave/NW 1st St	1	0	0	1
NW 2nd Ave/Verde Dr	0	1	0	1
NW 3rd Ave/NW 3rd St	0	1	0	1
NW 3rd Ave/NW 4th St	0	1	0	1
NW 4th Ave/NW 4th St	2	0	0	2
NW 4th Ave/NW 8th St	0	1	0	1
NW 4th Ave/Verde Dr	1	0	0	1
NW 5th Ave/NW 2nd St	1	1	0	2
NW 5th Ave/NW 3rd St	1	0	0	1
NW 5th Ave/NW 4th St	0	1	0	1
NW 6th Ave/NW 5th St	1	0	0	1
NW 6th Ave/NW 8th St	1	0	0	1
NW 7th Ave/NW 1st St	1	1	0	2
NW 7th Ave/NW 2nd St	1	1	0	2
NW 8th Ave/Fortner St	0	1	0	1



### Appendix C: Crash Data Summary By Intersection

Intersection	PDO	Injury	Fatal	Total
NW 8th Ave/NW 9th St	1	0	0	1
Olds Ferry-Ont Hwy/Fortner St	1	1	0	2
Olds Ferry-Ont Hwy/ManorWay	0	1	0	1
Olds Ferry-Ont Hwy/NW 11th Ave	0	1	0	1
Olds Ferry-Ont Hwy/NW 8th Ave	0	1	0	1
Oregon St/Idaho Ave	5	9	0	14
Oregon St/NW 1st Ave	1	3	0	4
Oregon St/NW 2nd Ave	2	2	0	4
Oregon St/NW 3rd Ave	0	2	0	2
Oregon St/NW 5th Ave	2	2	0	4
Oregon St/NW 6th Ave	0	1	0	1
Park Blvd/SW 4th Ave	6	4	0	10
SE 12th Ave/SE 2nd St	1	0	0	1
SE 13th Ave/Kendall Rd	2	0	0	2
SE 1st Ave/SE 2nd St	1	0	0	1
SE 1st Ave/SE 3rd St	2	2	0	4
SE 2nd Ave/SE 3rd St	3	1	0	4
SE 2nd Ave/SE 7th St	1	0	0	1
SE 3rd Ave/SE 3rd St	1	1	0	2
SE 3rd Ave/SE 5th St	0	1	0	1
SE 5th Ave/Oregon St	0	1	0	1
SE 5th Ave/SE 1st St	1	0	0	1
SE 5th Ave/SE 2nd St	3	0	0	3
SE 5th Ave/SE 4th St	1	0	0	1
SE 5th Ave/SE 5th St	0	1	0	1
SE 6th Ave/SE 2nd St	2	1	0	3
SE 6th Ave/SE 3rd St	0	1	0	1
SE 6th Ave/SE 5th St	0	1	0	1
SE 9th Ave/SE 2nd St	1	0	0	1
SE 9th Ave/SE 6th St	1	0	0	1
Sears Dr/SW 4th Ave	1	0	0	1
Sunset Dr/SW 4th Ave	4	1	0	5
SW 11th Ave/SW 4th St	2	0	0	2
SW 11th St/SW 4th Ave	1	3	0	4
SW 12th Ave/SW 11th St	1	0	0	1
SW 14th Ave/Park Blvd	1	0	0	1
SW 18th St/SW 4th Ave	2	2	0	4
SW 19th Ave/SW 4th St	2	2	0	4
SW 1st Ave/SW 11th St	1	0	0	1
SW 24th St/SW 4th Ave	1	0	0	1

### Appendix C: Crash Data Summary By Intersection

Intersection	PDO	Injury	Fatal	Total
SW 2nd Ave/Oregon St	1	0	0	1
SW 2nd Ave/SW 10th St	0	2	0	2
SW 2nd Ave/SW 3rd St	2	2	0	4
SW 2nd Ave/SW 5th St	1	0	0	1
SW 2nd Ave/SW 6th St	1	0	0	1
SW 2nd Ave/SW 9th St	1	1	0	2
SW 2nd St/SW 3rd Ave	1	0	0	1
SW 4th Ave/SW 2nd St	2	0	0	2
SW 3rd Ave/Oregon St	3	0	0	3
SW 3rd Ave/SW 11th St	1	0	0	1
SW 3rd Ave/SW 12th St	0	1	0	1
SW 3rd Ave/SW 2nd St	1	0	0	1
SW 3rd Ave/SW 3rd St	1	1	0	2
SW 3rd Ave/SW 4th St	2	0	0	2
SW 3rd Ave/SW 6th St	1	0	0	1
SW 3rd Ave/SW 7th St	1	0	0	1
SW 3rd Ave/SW 9th St	2	0	0	2
SW 3rd St/SW 4th Ave	1	2	0	3
SW 4th Ave/Alameda Dr	0	1	0	1
SW 4th Ave/Dorian Dr	1	0	0	1
SW 4th Ave/Sunset Dr	1	0	0	1
SW 4th Ave/SW 11th St	1	0	0	1
SW 4th Ave/SW 12th St	2	8	0	10
SW 4th Ave/SW 13th St	1	2	0	3
SW 4th Ave/SW 1st St	5	1	0	6
SW 4th Ave/SW 2nd St	1	0	0	1
SW 4th Ave/SW 3rd St	0	1	0	1
SW 4th Ave/SW 4th St	1	0	0	1
SW 4th Ave/Verde Dr	10	5	0	15
SW 4th Ave/SW 4th St	10	16	0	26
SW 4th Ave/SW 5th St	7	4	0	11
SW 4th Ave/SW 9th St	2	5	0	7
SW 5th Ave/Alameda Dr	2	0	0	2
SW 5th Ave/Alley	1	0	0	1
SW 5th Ave/Oregon St	2	1	0	3
SW 5th Ave/Park Blvd	1	0	0	1
SW 5th Ave/SW 12th St	2	1	0	3
SW 5th Ave/SW 1st St	0	1	0	1
SW 5th Ave/SW 3rd St	1	0	0	1
SW 5th Ave/SW 4th St	6	0	0	6

**Appendix C: Crash Data Summary By Intersection**

Intersection	PDO	Injury	Fatal	Total
SW 5th Ave/SW 5th St	1	0	0	1
SW 6th Ave/SW 1st St	3	1	0	4
SW 6th Ave/SW 2nd St	2	1	0	3
SW 6th Ave/SW 3rd St	0	1	0	1
SW 6th Ave/SW 4th St	1	2	0	3
SW 6th St/SW 4th Ave	3	2	0	5
SW 7th Ave/SW 5th St	1	0	0	1
SW 7th Place/Sunset Dr	2	0	0	2
SW 7th St/SW 4th Ave	3	4	0	7
SW 9th Ave/SW 5th St	1	0	0	1

# Appendix D: Access Management Standards

## Access Management Spacing Standards

The following tables show the access spacing standards for the access management classifications listed in Goal 3, Policy 3A: Classification and Spacing Criteria, Action 3A.1.

**Table 12: Interchange Spacing**

①

Access Management Classification	Area	Interchange Spacing②③
Interstate* and Non-Interstate Freeways (NHS)	Urban	3 miles (5 kilometers)
	Rural	6 miles (10 kilometers)
All Expressways on Statewide (NHS), Regional and District Highways	Urban	1.9 miles (3 kilometers)
	Rural	3 miles (5 kilometers)

\* Interstate interchange spacing must be in conformance with federal policy.

① The spacing standards in Table 12 are for planning and design of new interchanges on freeways or expressways. A major deviation study is required to change these standards, but the deviation should consider the spacing requirements in the Interchange Access Management Area Tables 16-19.

② Crossroad to crossroad centerline distance.

③ A major deviations study is required to change these planning spacing standards.

**Table 13: Access Management Spacing Standards for Statewide Highways**  
①②

**(Measurement is in Feet)\***

Posted Speed③	Rural		Urban			
	Expressway**	Other	Expressway**	Other	UBA	STA
≥55	5280	1320	2640	1320		
50	5280	1100	2640	1100		
40 & 45	5280	990	2640	990		
30 & 35		770		770	720	④
≤25		550		550	520	④

NOTE: The numbers in circles (②) refer to explanatory notes that follow tables.

\*Measurement of the approach road spacing is from center to center on the same side of the roadway.

\*\*Spacing for Expressway at-grade intersections only. See Table 12 for interchange spacing.

**Table 14: Access Management Spacing Standards for Regional Highways**  
①②

**(Measurement is in Feet)\***

Posted Speed③	Rural		Urban			
	Expressway**	Other	Expressway**	Other	UBA	STA
≥55	5280	990	2640	990		
50	5280	830	2640	830		
40 & 45	5280	750	2640	750		
30 & 35		600		600	425	④
≤25		450		450	350	④

NOTE: The numbers in circles (②) refer to explanatory notes that follow tables.

\* Measurement of the approach road spacing is from center to center on the same side of the roadway.

\*\*Spacing for Expressway at-grade intersections only. See Table 12 for interchange spacing.

**Table 15: Access Management Spacing Standards for District Highways**  
 ①②  
 (Measurement is in Feet)\*

Posted Speed③	Rural		Urban			
	Expressway**	Other	Expressway**	Other	UBA	STA
≥55	5280	700	2640	700		
50	5280	550	2640	550		
40 & 45	5280	500	2640	500		
30 & 35		400		400	350	④
≤25		400		400	350	④

NOTE: The numbers in circles (②) refer to explanatory notes that follow tables.

\* Measurement of the approach road spacing is from center to center on the same side of the roadway.

\*\*Spacing for Expressway at-grade intersections only. See Table 12 for interchange spacing.

**Notes on Tables 13, 14 and 15:**

① Where a right of access exists, access will be allowed to a property at less than the designated spacing standard only if that property does not have reasonable access and the designated spacing cannot be accomplished. If possible, other options should be considered such as joint access.

Where the right of access exists, the number of approach roads (driveways) to a single property shall be limited to one, even when the property frontage exceeds the spacing standards. More than one approach road may be considered if, in the judgment of the Region Access Management Engineer, additional approach roads are necessary to accommodate and service the traffic to a property, and additional approach roads will not interfere with driver expectancy and the safety of the through traffic on the highway.

Approach roads shall be located where they do not create undue interference or hazard to the free movement of normal highway or pedestrian traffic. Locations on sharp curves, steep grades, areas of restricted sight distance or at points which interfere with the placement and proper functioning of traffic control signs, signals, lighting or other devices that affect traffic operation will not be permitted.

If a property becomes landlocked (no reasonable access exists) because an approach road cannot be safely constructed and operated, and all other alternatives have been explored and rejected, ODOT might be required to purchase the property. (Note: If a hardship is self-inflicted, such as by partitioning or subdividing a property, ODOT does not have responsibility for purchasing the property.)

***(Note ① has precedence over notes ②, ③ and ④.)***

② These standards are for unsignalized access points only. Signal spacing standards supersede spacing standards for approaches.

③ Posted (or Desirable) Speed: Posted speed can only be adjusted (up or down) after a speed study is conducted and that study determines the correct posted speed to be different than the current posted speed. In cases where actual speeds are suspected to be much higher than posted speeds, ODOT reserves the right to adjust the access spacing accordingly. A determination can be made to go to longer spacing standards as appropriate for a higher speed. A speed study will need to be conducted to determine the correct speed.

④ Minimum spacing for public road approaches is either the existing city block spacing or the city block spacing as identified in the local comprehensive plan. Public road connections are preferred over private driveways, and in STAs driveways are discouraged. However, where driveways are allowed and where land use patterns permit, the minimum spacing for driveways is 175 feet (55 meters) or mid-block if the current city block spacing is less than 350 feet (110 meters).

**Access Management Spacing Standards for Interchanges**

The following tables show the access spacing standards for interchanges as discussed in Goal 3, Policy 3C: Interchange Access Management Areas.

**Table 16: Minimum Spacing Standards Applicable to Freeway Interchanges with Two-Lane Crossroads**

Category of Mainline	Type of Area	Spacing Dimension			
		A	X	Y	Z
FREEWAY	Fully Developed Urban	1 mi. (1.6 km)	750 ft. (230 m)	1320 ft. (400 m)	750 ft. (230 m)
	Urban	1 mi. (1.6 km)	1320 ft. (400 m)	1320 ft. (400 m)	990 ft. (300 m)
	Rural	2 mi. (3.2 km)	1320 ft. (400 m)	1320 ft. (400 m)	1320 ft. (400 m)

Notes: 1) If the crossroad is a state highway, these distances may be superseded by the Access Management Spacing Standards, providing the distances are greater than the distances listed in the above table.

2) No four-legged intersections may be placed between ramp terminals and the first major intersection.

A = Distance between the start and end of tapers of adjacent interchanges

X = Distance to the first approach on the right; right in/right out only

Y = Distance to first major intersection; no left turns allowed in this roadway section

Z = Distance between the last right in/right out approach road and the start of the taper for the on-ramp

**Figure 18: Measurement of Spacing Standards for Table 16**

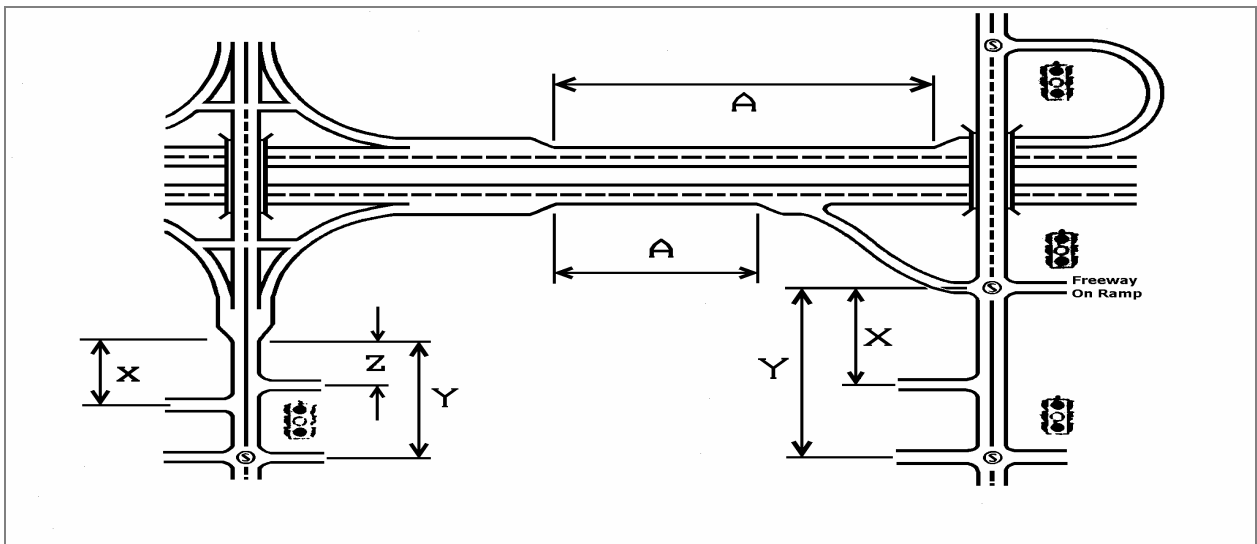



**Table 17: Minimum Spacing Standards Applicable to Freeway Interchanges with Multi-Lane Crossroads**

Category of Mainline	Type of Area	Spacing Dimension				
		A	X	Y	Z	M
<b>FREEWAY</b>	Fully Developed Urban	1 mi. (1.6 km)	750 ft. (230 m)	1320 ft. (400 m)	990 ft. (300 m)	1320 ft. (400 m)
	Urban	1 mi. (1.6 km)	1320 ft. (400 m)	1320 ft. (400 m)	1320 ft. (400 m)	1320 ft. (400 m)
	Rural	2 mi. (3.2 km)	1320 ft. (400 m)	1320 ft. (400 m)	1320 ft. (400 m)	1320 ft. (400 m)

- Notes: 1) If the crossroad is a state highway, these distances may be superseded by the Access Management Spacing Standards, providing the distances are greater than the distances listed in the above table.
- 2) No four-legged intersections may be placed between ramp terminals and the first major intersection.

A = Distance between the start and end of tapers of adjacent interchanges

X = Distance to first approach on the right; right in/right out only

Y = Distance to first major intersection

Z = Distance between the last approach road and the start of the taper for the on-ramp

M = Distance to first directional median opening. No full median openings are allowed in nontraversable medians to the first major intersection

**Figure 19: Measurement of Spacing Standards for Table 17**

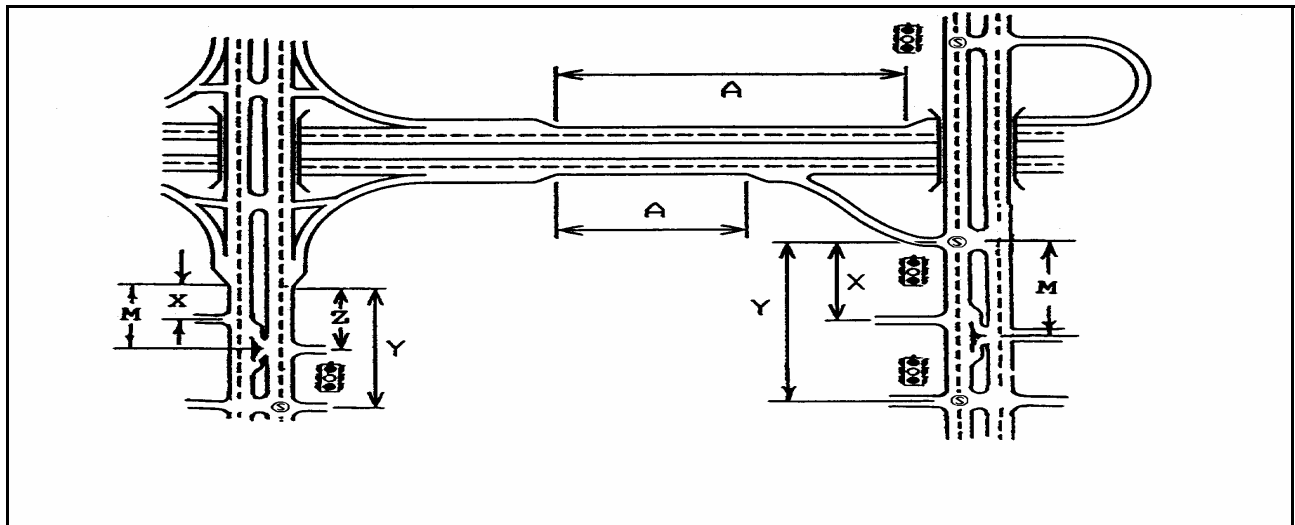

**Table 18: Minimum Spacing Standards Applicable to Non-Freeway Interchanges with Two-Lane Crossroads**

Category of Mainline	Type of Area	Speed of Mainline	Spacing Dimension				
			B	C	X	Y	Z
<b>EXPRESSWAY</b>	Fully Developed Urban	45 mph (70 kph)	2640 ft. (800 m)	1 mi. (1.6 km)	750 ft. (230 m)	1320 ft. (400 m)	750 ft. (230 m)
	Urban	45 mph (70 kph)	2640 ft. (800 m)	1 mi. (1.6 km)	1320 ft. (400 m)	1320 ft. (400 m)	990 ft. (300 m)
	Rural	55 mph (90 kph)	1 mi. (1.6 km)	2 mi. (3.2 km)	1320 ft. (400 m)	1320 ft. (400 m)	1320 ft. (400 m)

- Notes: 1) If the crossroad is a state highway, these distances may be superseded by the Access Management Spacing Standards, providing the distances are greater than the distances listed in the above table.
- 2) No four-legged intersection may be placed between ramp terminals and the first major intersection.
- 3) Use four-lane crossroad standards for urban and suburban locations that are likely to be widened.
- 4) No at-grade intersections are permitted between interchanges less than 5 miles apart.

B = Distance between the start and end of tapers

C = Distance between nearest at-grade and ramp terminal intersections or the end/start of the taper section

X = Distance to first approach on the right; right in/right out only

Y = Distance to first major intersection

Z = Distance between the last right in/right out approach road and the start of the taper for the on-ramp

**Figure 20: Measurement of Spacing Standards for Table 18**

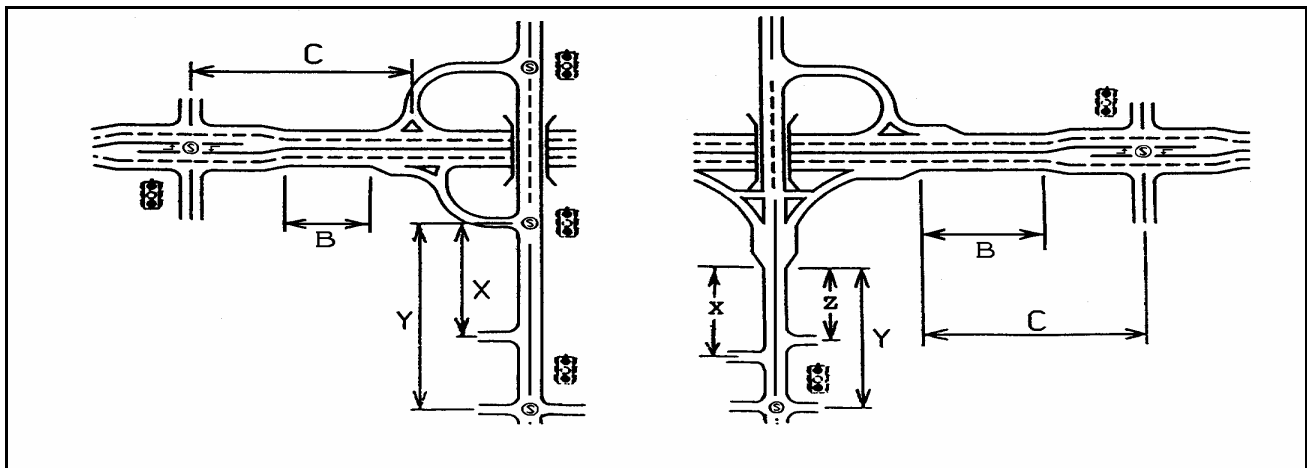

**Table 19: Minimum Spacing Standards Applicable to Non-Freeway Interchanges with Multi-Lane Crossroads**

Category of Mainline	Type of Area	Speed of Mainline	Spacing Dimension					
			B	C	X	Y	Z	M
<b>EXPRESSWAY</b>	Fully Developed Urban	45 mph (70 kph)	2640 ft. (800 m)	1 mi. (1.6 km)	750 ft. (230 m)	1320 ft. (400 m)	990 ft. (300 m)	1320 ft. (400 m)
	Urban	45 mph (70 kph)	2640 ft. (800 m)	1 mi. (1.6 km)	1320 ft. (400 m)	1320 ft. (400 m)	1320 ft. (400 m)	1320 ft. (400 m)
	Rural	55 mph (90 kph)	1 mi. (1.6 km)	2 mi. (3.2 km)	1320 ft. (400 m)	1320 ft. (400 m)	1320 ft. (400 m)	1320 ft. (400 m)

- Notes: 1) If the crossroad is a state highway, these distances may be superseded by the Access Management Spacing Standards, providing the distances are greater than the distances listed in the above table.
- 2) No four-legged intersections may be placed between ramp terminals and the first major intersection.
- 3) No at-grade intersections are permitted between interchanges less than 5 miles apart.

B = Distance between the start and end of tapers

C = Distance between nearest at-grade and ramp terminal intersections or the end/start of the taper section

X = Distance to first approach on the right; right in/right out only

Y = Distance to first major intersection

Z = Distance between the last approach road and the start of the taper for the on-ramp

M = Distance to first directional median opening. No full median openings are allowed in nontraversable medians to the first major intersection

**Figure 21: Measurement of Spacing Standards for Table 19**

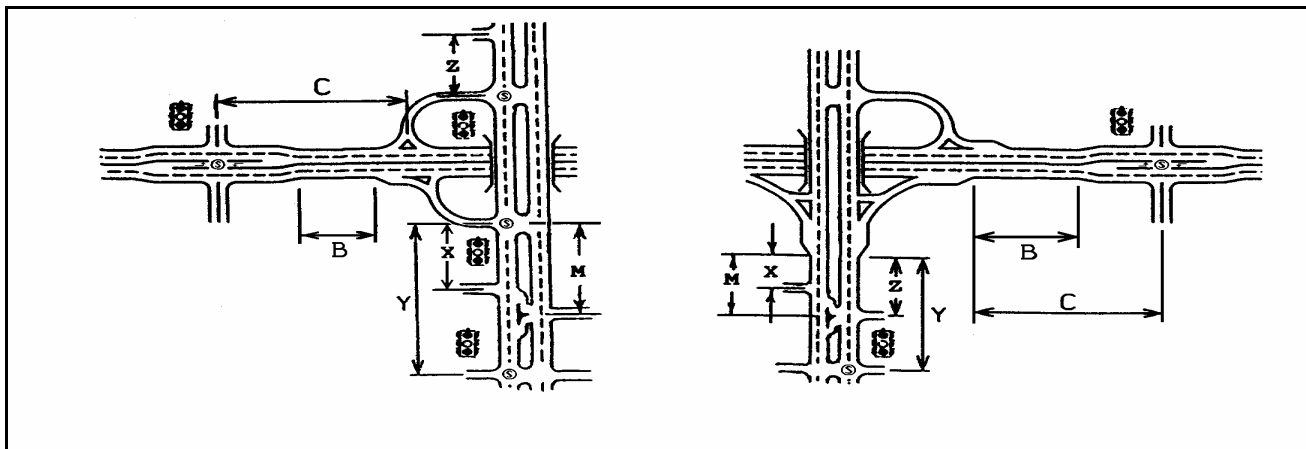

**Access Management Spacing Standard Minor Deviation Limits**

The following tables show the access management spacing standard minor deviation limits for the access management classifications listed in Goal 3, Policy 3A: Classification Spacing Criteria, Action 3A.1. The Access Management Spacing Standards are shown in Tables 13, 14 and 15 of this Appendix. Minor deviations may be considered down to the deviation limits shown in Tables 20, 21 and 22. Any request to deviate beyond these limits is considered a major deviation.

**Table 20: Access Management Spacing Standard Minor Deviation Limits for Statewide Highways**

①②

(Measurement is in Feet)\*

Posted Speed③	Rural		Urban			
	Expressways**	Other	Expressways**	Other	UBA	STA
≥55	(none)	(950)	(none)	(870)		
	[none]	[1150]	[none]	[1000]		
50	(none)	(700)	(none)	(640)		
	[none]	[900]	[none]	[810]		
40 & 45	(none)	(560)	(none)	(530)		
	[none]	[810]	[none]	[740]		
30 & 35		(400)		(350)	(350)	④
		[675]		[600]	[600]	
≤25		(280)		(250)	(250)	④
		[525]		[400]	[400]	

NOTE: The numbers in circles (②) refer to explanatory notes that follow the tables.

\*Measurement of the approach road spacing is from center to center on the same side of the roadway.

\*\*Spacing for Expressway at-grade intersections only. See Table 12 for interchange spacing.

(\_\_\_\_) = Driveway Spacing Minor Deviation Limit.

[\_\_\_\_] = Public Street Spacing Minor Deviation Limit.

**Table 21: Access Management Spacing Standard Minor Deviation Limits for Regional Highways**

①②

(Measurement is in Feet)\*

Posted Speed③	Rural		Urban			
	Expressways**	Other	Expressways**	Other	UBA	STA
≥55	(none)	(700)	(none)	(700)		
	[none]	[870]	[none]	[870]		
50	(none)	(540)	(none)	(540)		
	[none]	[640]	[none]	[640]		
40 & 45	(none)	(460)	(none)	(460)		
	[none]	[550]	[none]	[550]		
30 & 35		(300)		(300)	(300)	④
		[375]		[375]	[375]	
≤25		(220)		(220)	(220)	④
		[350]		[350]	[350]	

NOTE: The numbers in circles (②) refer to explanatory notes that follow the tables.

\*Measurement of the approach road spacing is from center to center on the same side of the roadway.

\*\*Spacing for Expressway at-grade intersections only. See Table 12 for interchange spacing.

(\_\_\_\_) = Driveway Spacing Minor Deviation Limit.

[\_\_\_\_] = Public Street Spacing Minor Deviation Limit.

**Table 22: Access Management Spacing Standard Minor Deviation Limits for District Highways**

①②  
(Measurement is in Feet)\*

Posted Speed③	Rural		Urban			
	Expressways**	Other	Expressways**	Other	UBA	STA
≥55	(none)	(650)	(none)	(650)		
	[none]	[660]	[none]	[660]		
50	(none)	(475)	(none)	(475)		
	[none]	[525]	[none]	[525]		
40 & 45	(none)	(400)	(none)	(400)		
	[none]	[475]	[none]	[475]		
30 & 35		(275)		(275)	(250)	④
		[325]		[325]	[300]	
≤25		(200)		(200)	(175)	④
		[245]		[245]	[200]	

NOTE: The numbers in circles (②) refer to explanatory notes that follow the tables.

\*Measurement of the approach road spacing is from center to center on the same side of the roadway.

\*\*Spacing for Expressway at-grade intersections only. See Table 12 for interchange spacing.

(\_\_\_\_) = Driveway Spacing Minor Deviation Limit.

[\_\_\_\_] = Public Street Spacing Minor Deviation Limit.

**Notes on Tables 20, 21 and 22:**

① Where a right of access exists, access will be allowed to a property at less than minor deviation limits only if that property does not have reasonable access and the minor deviation limits cannot be accomplished. If possible, other options should be considered, such as joint access.

Where the right of access exists, the number of approach roads (driveways) to a single property shall be limited to one, even when the property frontage exceeds the spacing standards. More than one approach road may be considered if, in the judgment of the Region Access Management Engineer, additional approach roads are necessary to accommodate and service the traffic to a property, and additional approach roads will not interfere with driver expectancy and the safety of the through traffic on the highway.

Approach roads shall be located where they do not create undue interference or hazard to the free movement of normal highway or pedestrian traffic. Locations on sharp curves, steep grades, areas of restricted sight distance or at points which interfere with the placement and proper functioning of traffic control signs, signals, lighting or other devices that affect traffic operation will not be permitted.

If a property becomes landlocked (no reasonable access exists) because an approach road cannot be safely constructed and operated, and all other alternatives have been explored and rejected, ODOT might be required to purchase the property. (Note: If a hardship is self-inflicted, such as by partitioning or subdividing a property, ODOT does not have responsibility for purchasing the property.)

***(Note ① has precedence over notes ②, ③ and ④.)***

② These standards are for unsignalized access points only. Signal spacing standards supersede spacing standards for approaches.

③ Posted (or Desirable) Speed: Posted speed can only be adjusted (up or down) after a speed study is conducted and that study determines the correct posted speed to be different than the current posted speed. In cases where actual speeds are suspected to be much higher than posted speeds, ODOT reserves the right to adjust the access spacing accordingly. A determination can be made to go to longer spacing standards as appropriate for a higher speed. A speed study will need to be conducted to determine the correct speed.

④ Minimum spacing for public road approaches is either the existing city block spacing or the city block spacing as identified in the local comprehensive plan. Public road connections are preferred over private driveways, and in STAs driveways are discouraged. However, where driveways are allowed and where land use patterns permit, the minimum spacing for driveways is 55 meters (175 feet), or mid-block if the current city block spacing is less than 110 meters (350 feet).