

**EXHIBIT A**

**CITY OF PORTLAND**  
**FREIGHT**  
**MASTER**  
**PLAN**

**Planning Commission**  
**Recommendation to City Council**



**February, 2006**  
**CITY OF PORTLAND**  
**OFFICE OF TRANSPORTATION**

## **ACKNOWLEDGEMENTS**

### **Portland City Council**

Tom Potter, Mayor  
Sam Adams, Commissioner  
Randy Leonard, Commissioner  
Dan Saltzman, Commissioner  
Erik Sten, Commissioner  
Gary Blackmer, City Auditor

### **City of Portland Planning Commission**

Ingrid Stevens, President  
Paul R. Schlesinger, Vice President  
Timothy W. Smith, Vice President  
Christine Caruso  
Don Hanson  
Larry Hilderbrand  
Gail Shibley

### **City of Portland Office of Transportation**

Sam Adams, Commissioner of Public Utilities  
Sue Keil, Director  
Paul Smith, Transportation Planning Division Manager

### **Office of Transportation Project Staff**

John Gillam, Policy Section Manager  
Deena Platman, Project Manager  
Jeanne Harrison, Senior Transportation Planner  
Lewis Wardrip, Senior Engineer  
Peter Mason, Traffic Engineering Associate  
Joseph Neilson, GIS Technician  
Samy Fouts, Graphics Support  
Sumi Malik, Staff Assistant  
Judith Fouts, Administrative Support

### **Past Assistance**

Jim Francesconi, former Public Works Commissioner  
Brant Williams, former Director  
Laurel Wentworth, Transportation Planning Division Manager  
Steve Gerber, Senior Transportation Planner

### **Consultant Team**

Sorin Garber Consulting Group  
PB Consulting  
David Evans & Associates

This project is partially funded by a grant from the Transportation and Growth Management (TGM) Program, a joint program of the Oregon Department of Transportation and the Oregon Department of Land Conservation and Development. This TGM grant is financed, in part, by funds provided by the federal Transportation Equity Act for the 21st Century (TEA-21), the City of Portland, and the State of Oregon.

The contents of this document do not necessarily reflect views of policies of the State of Oregon.

CITY OF PORTLAND  
**FREIGHT  
MASTER  
PLAN**

Planning Commission  
Recommendation to City Council





The Freight Master Plan was developed with the dedicated and valuable assistance from the following people:

### **Portland Freight Committee Committee Members**

Steve Bates

William D. Burgel

Tom Dechenne

David Eveson

Ann Gardner, Committee Chairperson

Jerry Grossnickle

Chris Hammond

Wayne Kingsley

Bill Maris

Thomas Rowe

Bob Short

Dick Swennes

Charles Tindall

Elizabeth Wainwright

Tracy Ann Whalen

Linda Braden

Corky Collier

Gary Eichman, Committee Vice-Chairperson

Jan M. Frost

Peter George

Bruce Halperin

Marion Haynes

Lee Johnson

Greg Miller

Robert Russell

Marsden Smith

Dan Spahr

John Trumbull

Howard Werth

### **Associate Members**

Nick Fortey, Federal Highway Administration

Steve Kountz, Portland Planning Bureau

Susie Lahsene, Port of Portland

Jason Tell, Oregon Department of Transportation

Thomas Picco, Oregon Department of Transportation

Shelli Romero, Multnomah County

Colin Sears, Portland Development Commission

Laurel Wentworth, Portland Office of Transportation

Bridget Wieghart, Metro

Randy Evans, Portland Development Commission

### **Technical Advisory Committee**

Rob Barnard, Project Management

Rob Burchfield, Traffic Operations

Ramon Corona, Parking Control

John Gray, Metro

Bill Kloos, Signals and Street Lighting

Mark Lear, Traffic Investigations

David O'Longaigh, Bridges and Structures

Lewis Wardrip, Traffic Design

April Bertelsen, Interim Pedestrian Coordinator

Mike Coleman, Traffic Design

Sorin Garber, Consultant

Roger Geller, Bicycle Coordinator

Dave Hutson, Bureau of Maintenance

Steve Kountz, Bureau of Planning

Lidwien Rahman, ODOT

Ning Zhou, Transportation Planning

For more information about the City of Portland Freight Master Plan, contact:

John Gillam  
Portland Office of Transportation  
1120 SW Fifth Ave, Room 800  
Portland OR 97204

Phone: 503-823-5185 (use our main line)  
Fax: 503-823-7609  
TDD: 503-823-6868

Website: [www.portlandtransportation.org](http://www.portlandtransportation.org)  
click on Freight Master Plan under Projects and Planning

# TABLE OF CONTENTS

<b>1. INTRODUCTION</b>	<b>1</b>
Rivers, Rails, Runways and Roads	1
West Coast Freight Hub	3
Freight Moves Portland's Economy	4
Trends Influencing Freight Movement	5
Planning Ahead for Freight	6
Portland's Freight Master Plan	7
Relationship to the Comprehensive Plan and the Transportation System Plan	9
Coordination With Other Freight Mobility Plans and Programs	10
<b>2. SETTING THE COURSE</b>	<b>11</b>
Introduction	11
Assessing the Freight System	11
A Course of Action	15
<b>3. POLICIES AND OBJECTIVES</b>	<b>17</b>
Introduction	17
Policy Framework	17
Relationship to Portland Transportation's System Plan	19
Relationship to Other City Documents	19
Comprehensive Plan Policies for Freight	20
The Freight System	21
<b>4. IMPLEMENTING THE PLAN</b>	<b>25</b>
Introduction	25
Actions and Activities	25
Moving Ahead	27
Monitoring Success	27
<b>5. FREIGHT SYSTEM IMPROVEMENTS</b>	<b>29</b>
Introduction	29
What is a Freight Improvement?	29
Types of Freight Improvements	29
Setting Infrastructure Priorities	30
Freight Infrastructure Improvements	30
Funding the Freight System	40
<b>6. TRUCKS AND STREET DESIGN</b>	<b>41</b>
Introduction	41
Planning for Trucks in the Right-of-Way	41
"Design For" Versus "Accommodate" Approaches to Addressing Truck Access	44
Considering Trucks in Design	45

## APPENDICES

Appendix A: Comprehensive Plan Policies for Freight Mobility . . . . .	A-1
Appendix B: Freight System Infrastructure Improvements . . . . .	B-1
Appendix C: Federal, State, Regional, and Local Transportation Financing in Portland and Oregon . . . . .	C-1
Appendix D: Preparing the Plan – Public Involvement . . . . .	D-1
Appendix E: References . . . . .	E-1

## LIST OF TABLES

Table 1 Industry Share of Employment in Portland Region as Percent of Average Share in U.S. . . . .	4
Table 2 1997 – 2030 Growth in Freight Tonnage . . . . .	6
Table 3 Freight Classifications by Activity Type . . . . .	22
Table 4 Freight System Performance Measures . . . . .	28
Table 5 Prioritization Criteria for Highway and Street Infrastructure Improvements for Freight . . . . .	31
Table 6 Truck Design Vehicle Characteristics and Turning Movement Information . . . . .	42

## LIST OF FIGURES

Figure 1 Waterways and Terminals . . . . .	1
Figure 2 Railroad Network . . . . .	2
Figure 3 Freeway and Highway Network . . . . .	2
Figure 4 Freight Centers by Tonage . . . . .	3
Figure 5 Oregon’s Major Freight Corridors . . . . .	3
Figure 6 Commodity Share in Portland Region as % of Tonnage . . . . .	4
Figure 7 Fred Meyer’s Patio Furniture Finished Product Distribution Story . . . . .	5
Figure 8 Freight Network Map . . . . .	23
Figure 9 Highway Improvements . . . . .	32
Figure 10 Street Improvements – N & NW Portland . . . . .	33
Figure 11 Street Improvements – NE Portland . . . . .	34
Figure 12 Street Improvements – Central Eastside Portland . . . . .	35
Figure 13 System Management Improvements . . . . .	36
Figure 14 Bridge Improvements . . . . .	37
Figure 15 Rail Improvements . . . . .	38
Figure 16 Marine Improvements . . . . .	39
Figure 17 Dimensions of Typical Design Vehicles . . . . .	41
Figure 18 Illustration of Large Truck at Four-Lane Intersection . . . . .	43
Figure 19 Illustration of Large Truck at Two-Lane Intersection . . . . .	43
Figure 20 Examples of “Design For” and “Accommodate” in Truck Design . . . . .	44



From its early days, Portland has been a center of trade and commerce in the Pacific Northwest. The city's growth has been driven by its role in the movement of commodities. At the turn of the 21<sup>st</sup> century, Portland has established strong international trade connections. The regional economy has shifted from one focused on processing and shipping raw materials to one that builds consumer electronics, designs apparel, and serves as a gateway for imported automobiles. River commerce has grown into a network of intermodal terminals connected to the Pacific Northwest and rest of the nation by a superior rail and interstate highway network. Portland's international airport is used to ship high value cargo to Asia and is poised for substantial growth.

Today, Portland is a competitive gateway for international and domestic trade. It is a "trans-shipment" center, where freight is handled on the way to somewhere else. In fact, more goods move through its transportation network to national and international destinations than are consumed here in the region.

The economy of the Portland metropolitan region relies on the movements of goods, ideas and people. The ability to move these goods efficiently is critical to regional competitiveness and affordability, not only for businesses but also for all citizens.

## RIVERS, RAILS, RUNWAYS AND ROADS

A combination of geography and multimodal freight infrastructure assures Portland's role as a center for goods distribution to and from the Pacific Northwest and throughout the world. Portland's freight system is comprised of waterborne, rail, air, pipeline, and truck transportation networks.

The city lies at the confluence of the navigable waters of the Columbia and Willamette rivers. The Columbia River links Portland to both Pacific Rim trade opportunities and the rich agriculture and resource lands of the interior Northwest. The 40-foot deep channel allows ocean-going vessels to navigate upstream to Portland's deep-water port. Barges carry agricultural and wood products, metals, and containers from upriver ports as far east as Lewiston, Idaho to Portland's marine terminal facilities.

Portland Harbor, a twelve-mile stretch of the Willamette River and two miles along the Columbia River, provides maritime access for the industrial uses situated along its banks.

The Port of Portland operates several deep-water marine terminal facilities along the Columbia and Willamette rivers.



**Figure 1 - Waterways and Terminals**





Two Class I railroads, the Burlington Northern & Santa Fe Railroad (BNSF) and the Union Pacific Railroad, connect Portland with national rail services and markets along the west coast and to major Midwest and Eastern United States markets. The city is also served by several branch rail lines, which distribute freight to and from the Class I railroads, as well as between local customers.

The North Portland Junction is where Union Pacific trains enter and leave the BNSF main line bound for Vancouver, Washington, Kalama/Longview, Washington, and the Puget Sound area. The BNSF Columbia Rail Bridge provides the only river crossing in the region. The nearest Columbia River crossing for trains is in The Dalles, Oregon.

Four main line rail routes converge in Portland:

- BNSF north to Seattle and Vancouver, British Columbia
- BNSF east to Chicago via Kansas City
- Union Pacific south to Oakland and Los Angeles, then across the Southwest to New Orleans
- Union Pacific east to Chicago via Salt Lake City and Denver

**Figure 2 - Railroad Network**

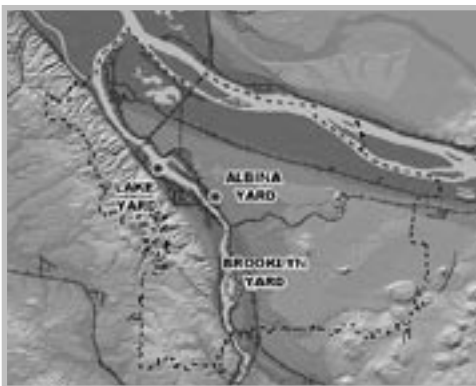

For travel to and from the east, the BNSF and Union Pacific routes through the Columbia Gorge are the preferred route for transcontinental trains as the tracks run at-grade with the Columbia River through the Cascade Range avoiding the steep grades of the Stampede Pass and Stevens Pass routes in Washington state.

Union Pacific operates two large rail yards in the City – Brooklyn Yard in Southeast Portland and Albina Yard in North Portland. BNSF operates two rail yards in Portland, Lake Yard and Willbridge Yard in the Northwest Industrial district, as well as its Vancouver Yard in Vancouver WA.

Portland International Airport, located entirely within the city of Portland, provides passenger and air cargo service for the Portland metropolitan area, including southwest Washington. Many air carriers provide domestic and international cargo transport in and out of the region.

**Figure 3 - Freeway and Highway Network**



Without local petroleum refineries, all of the Portland/Vancouver metropolitan region’s fuel must be imported from Puget Sound refineries. The Olympic pipeline is the primary mode for transporting gasoline, diesel, and jet fuel to the region. This 400-mile common carrier pipeline transports approximately 12.3 million gallons of fuel per day – the daily equivalent of 1,500 tanker trucks traveling Interstate 5. Portland is also the terminus for the Kinder Morgan pipeline, which distributes fuel products from Portland into the Willamette Valley.

The link to all these modes is the network of freeways, highways, streets that connect the City’s various modes of freight transport to their destinations. Two interstate freeways intersect in the heart of Portland. I-5 is the primary West Coast truck freight route linking urban centers between Canada and

Mexico. Portland is the terminus for I-84, a primary freight route between the Pacific Northwest and Salt Lake City, where it merges with I-80 to the East Coast. I-205, I-405, US 26, US 30, and McLoughlin Blvd (OR 99E) are highways that facilitate intra-regional truck freight movement.

Portland's streets are the first and last mile connections for trucks moving freight to and from marine terminals, rail yards, the airport, and industrial businesses. Trucks also use city streets to deliver goods and services to local businesses and residents.

## WEST COAST FREIGHT HUB

The Portland/Vancouver region is the fourth largest freight hub on the West Coast behind Los Angeles/Long Beach, Seattle/Tacoma and San Francisco/Oakland. As shown in Figure 4, the region's tonnage levels are approximately the same as those in Phoenix, Denver and San Diego, areas with larger economic markets and population.

Portland also serves as Oregon's freight hub. Figure 5 shows how the State's most vital highway, railroad and marine freight routes converge in Portland.

Portland's freight hub is further characterized by its 12,500 acres of industrial land surrounding the Portland Harbor and the Portland International Airport. Most of the parcels in these industrial districts have multimodal freight access. Heavy industrial activities—marine terminals, rail yards, and large manufacturers—are the primary occupants of the industrial properties. When compared with other U.S. cities, Portland demonstrates a relatively centralized landscape of regionally significant industrial land, freight infrastructure, and industry clusters (distribution, metals, transportation equipment).

The key economic advantages of the Portland freight hub are that it provides access to the global economy, generates thousands of permanent family-wage jobs, and reduces transportation costs for Portland manufacturers, carriers, and shippers.<sup>1</sup>

<sup>1</sup>According to the Port of Portland Marine Economic Impact Study: Container Transportation Cost-Benefit Analysis (prepared by HDR Engineering, Inc. and John Martin & Associates for the Port of Portland, December 2000), the Port of Portland's container facilities save Portland shippers \$67.9 million annually.

**Figure 4  
Freight Centers by Tonnage**

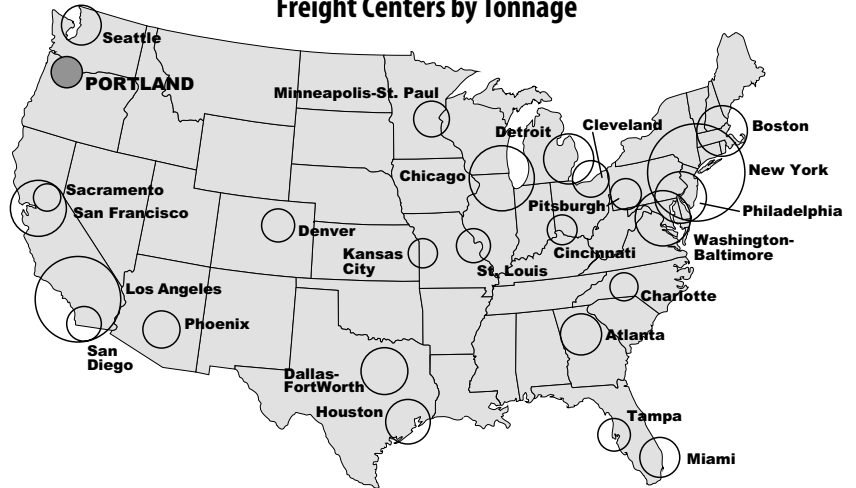

**Figure 5  
Oregon's Major Freight Corridors**

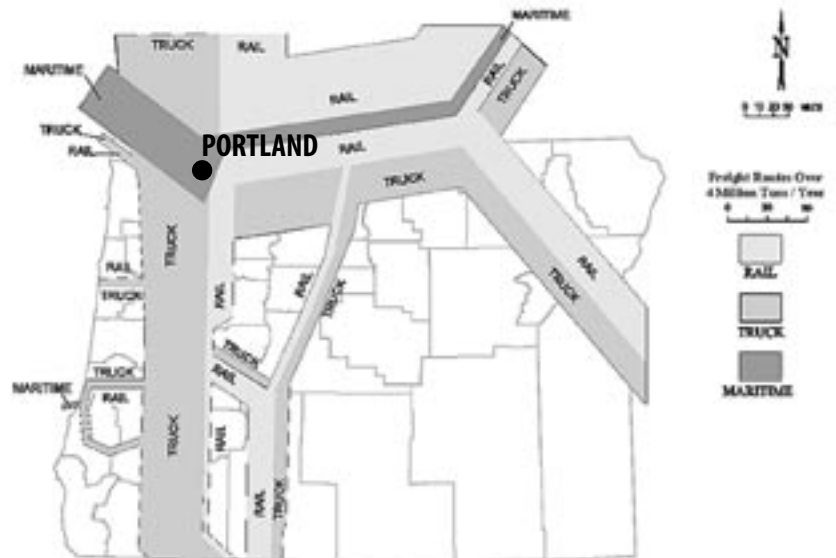

Source: Surface Transportation Board Waybill Sample, ODOT Transportation Data Section, U.S. Army Corps of Engineers, Waterborne Commerce of U.S.

## WHAT IS FREIGHT?

The term “freight” is used generically throughout this plan to mean the commercial transport of goods. “Freight” encompasses different types of movement from the transport of bulk items such as grain, lumber, and fuel to delivery of products and services to local businesses and residences.

The term “goods” is also generically used in the plan to refer to all items, except services, that can be moved commercially.

“Goods” are transported by multiple and often interconnected freight modes – waterborne, air, rail, pipeline, and truck – as they move between origin and destination. While goods and services can also be moved on foot, by bike and by car, this plan is focused on the transport of goods by large commercial vehicles.

## FREIGHT MOVES PORTLAND’S ECONOMY

Portland’s investment in its transportation infrastructure has contributed directly to its importance as a transportation distribution center and has provided access to jobs in the region. In fact, transportation investments in the region have contributed to a 37 percent increase in industrial jobs in the Portland-Vancouver area between 1980 and 2000, compared to a national growth rate of 12 percent during the same period.<sup>2</sup>

More than most U.S. cities, Portland’s economy is dependent on freight movement. Table 1 illustrates that Portland’s regional employment in transportation-related industries far exceeds the US average for these sectors. According to the Oregon Department of Employment data, the transportation sector accounted for one out of every nine jobs in the Portland metro region in 2000.

**Table 1**  
**Industry Share of Employment in Portland Region as Percent of Average Share in U.S.**

<b>Air Transportation</b>	<b>120%</b>
<b>Trucking and Warehousing</b>	<b>128%</b>
<b>Wholesale Trade</b>	<b>138%</b>
<b>Water Transportation</b>	<b>169%</b>

Source: Planning Bureau, Portland Harbor Industrial Lands Study, 2003.

**Figure 6**  
**Commodity Share in Portland Region as % of Tonnage**

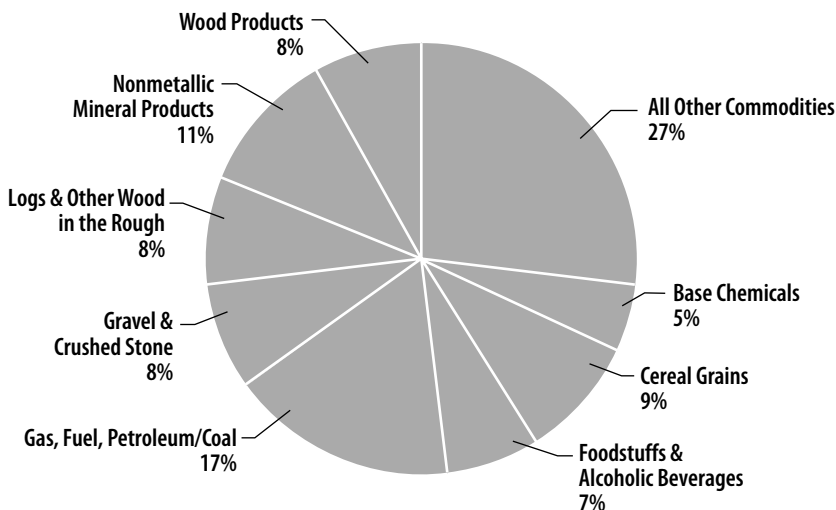

Source: Commodity Flow Forecast Update and Lower Columbia River Cargo Forecast, Port of Portland, Figure 2.1, 2002.

Figure 6 identifies the type of goods moved in the region by tonnage levels. Eight commodity categories account for 74 percent of all tons shipped on all freight modes. This is only part of the story. As Portland’s economy grows in the high-tech manufacturing sector, more high-valued, low-weight goods are being shipped. These types of commodities tend to move by truck and air.

<sup>2</sup> Industrial Districts Atlas, Portland Bureau of Planning, 2005, page 12.

## TRENDS INFLUENCING FREIGHT MOVEMENT

Changes in the national economy and business practices are triggering shifts in how goods are moved. With fewer industries storing goods and materials on-site, and the global demand for goods changing at a dramatic rate, the region is witnessing a growing emphasis in the use of logistics strategies to bring supplies to manufacturers for assembly, packaging and delivery. These strategies are linked to “supply chains” connected to a reliable and efficient transportation network that links origins and destinations, in many cases using multiple combinations of transport.

The “global supply chain” includes all of the activities associated with the flow and transformation of goods from raw materials to the end consumer. Figure 7 shows a portion of Fred Meyer’s patio furniture supply chain, the distribution of the finished product. Even this small slice of the total supply chain reflects the complexity of the global movement of goods.

**Figure 7**  
**Fred Meyer’s Patio Furniture Finished Product Distribution Story**

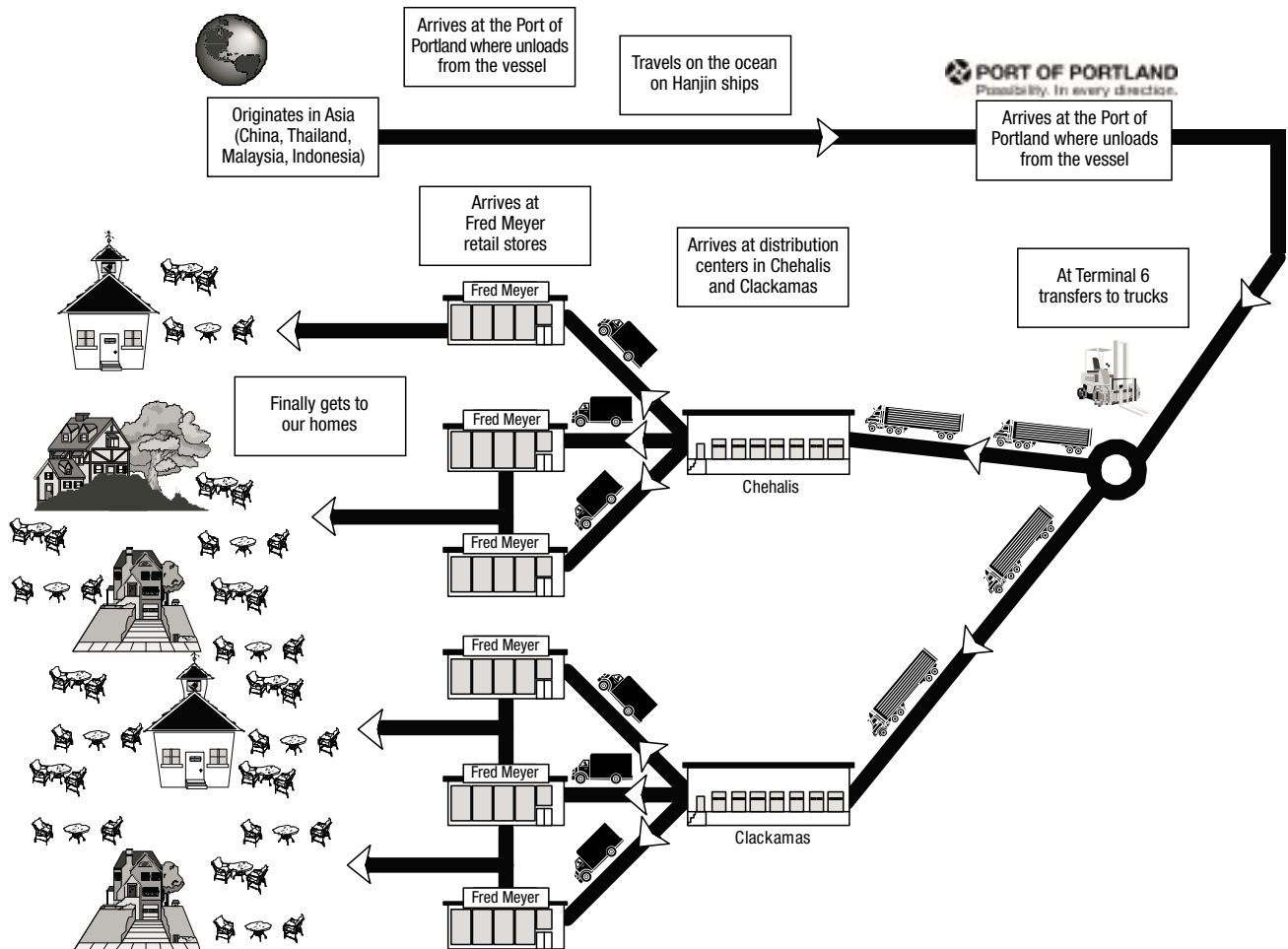

## PLANNING AHEAD FOR FREIGHT

According to the Commodity Flow Forecast,<sup>3</sup> demand for freight tonnage into, out of, and within the Portland region will grow from 260 million tons with a total value of \$352 billion in 1997 to 522 million tons with a combined value of \$827 billion by 2030.<sup>4</sup> Overall, tonnage volume demand will grow at an annual compound rate of 2.1 percent, led by the increase (in percentage terms) in use of air cargo (3.77%/year), trucks (2.53%/year), and rail (2.47%/year). The share of tonnage carried by truck will increase from 64 percent in 1997 to 73% in 2030; while tonnage by water modes (ocean and barge) will decline from a combined 15 percent to 10 percent, and tonnage by pipeline will decline from 11 percent to 6 percent over the 1997-2030 timeframe.<sup>5</sup> Tons carried by rail will increase by 1 percent and by 0.5 percent for air cargo.

**Table 2**  
**1997 - 2030 Growth in Freight Tonnage**  
(in millions of short-tons)

	1997	2030	Annual Change	2030 Share
<b>Truck</b>	<b>166.6</b>	<b>380.0</b>	<b>2.53%</b>	<b>73%</b>
<b>Pipeline</b>	<b>28.1</b>	<b>31.2</b>	<b>0.31%</b>	<b>6%</b>
<b>Ocean</b>	<b>25.3</b>	<b>34.8<sup>3</sup></b>	<b>0.97%</b>	<b>7%</b>
<b>Rail</b>	<b>26.4</b>	<b>59.2</b>	<b>2.47%</b>	<b>11%</b>
<b>Barge</b>	<b>14.1</b>	<b>15.5</b>	<b>0.29%</b>	<b>3%</b>
<b>Intermodal</b>	<b>11.8</b>	<b>n/a</b>	<b>n/a</b>	<b>n/a</b>
<b>Air</b>	<b>0.3</b>	<b>1.1</b>	<b>3.77%</b>	<b>&gt;1%</b>
<b>Total</b>	<b>260.8</b>	<b>521.8</b>	<b>2.12%</b>	<b>100.0%</b>

Source: Commodity Flow Forecast Update and Lower Columbia River Cargo Forecast, Port of Portland, June 2002.

Freight movement is expected to continue to be a central element of Portland's economy. Increasing freight volumes will put pressure on all elements of its freight transportation system – roads, rail, pipelines, and marine and air terminals. Many parts of the freight transportation system in Portland are managed by other public agencies and private operators. Coordination and partnership on efforts to accommodate the growth in freight movement will include individuals and organizations in both the public and private sectors.

The Freight Master Plan covers the broad range of freight transport modes but has a primary focus on truck freight mobility due to the City's jurisdiction over the street network. Trucks use city-owned roads to transport goods and services throughout the community. The share of trucks on our roads is anticipated to increase in the future, particularly in Freight Districts and on freeways and highways. Strategies for efficient, safe, and reliable movement of trucks will help manage this growth in a way that maintains Portland's community livability.



<sup>3</sup> *Commodity Flow Forecast Update and Lower Columbia River Cargo Forecast Final Report*, prepared for the Port of Portland, Metro, Oregon Department of Transportation, Port of Vancouver, Regional Transportation Council, prepared by DRI-WWEFA, BST Associates and Cambridge Systematics, Inc., June 30, 2002. [http://www.portlandairportpdx.com/pdfpop/MTMP\\_LCR\\_Cargo\\_Forecast\\_Final\\_Final\\_Report.pdf](http://www.portlandairportpdx.com/pdfpop/MTMP_LCR_Cargo_Forecast_Final_Final_Report.pdf).

<sup>4</sup> *Ibid.*, page 44.

<sup>5</sup> Commodity Flow Forecast combined freight tons and values using ocean and barge modes into one single "Water" mode.

# PORTLAND'S FREIGHT MASTER PLAN

## Plan Objectives

The Freight Master Plan provides a road map for managing freight movement and commercial delivery of goods and services in Portland, today and into the future. The goal is to foster a freight system that works for the community.

The Freight Master Plan objectives center around three main themes: mobility, livability, and healthy economy.

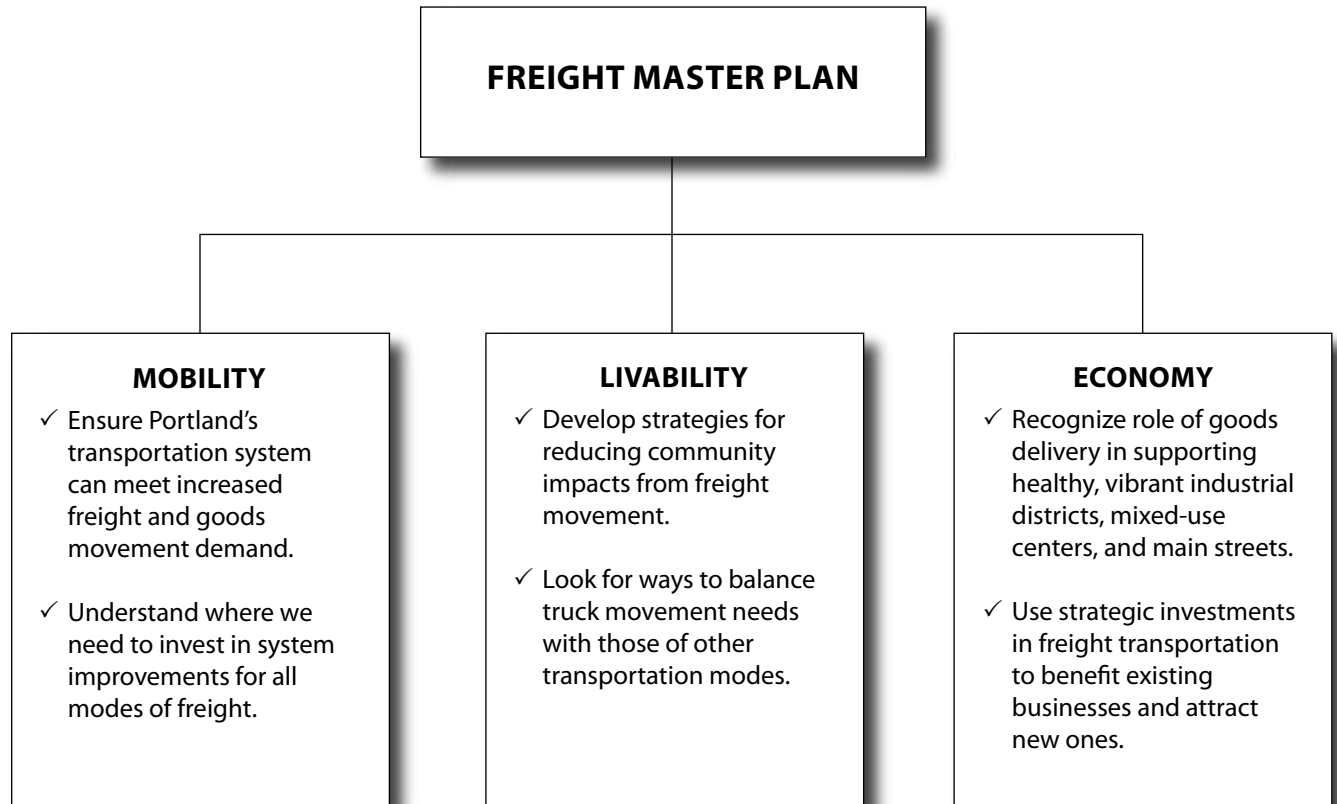

## Preparing the Plan

Portland completed its first Transportation System Plan (TSP) in 2002. During this process, the City recognized the need to better understand and plan for freight movement. The TSP identified a study to ascertain freight transportation system needs and deficiencies, and develop solutions.

The development of the Freight Master Plan occurred in two phases. The first phase of planning began in January 2003 and accomplished the following:

- Completion of the Freight Master Plan - Interim Report, which built the case for freight planning and identified the Plan's objectives.
- Adoption of a City Council resolution that acknowledged the importance of goods movement to Portland's economy, established the Portland Freight Committee, directed Portland Office of Transportation to develop a Freight Master Plan, and identified short-term opportunities for freight mobility improvements.
- Evaluation of existing freight policies, identification of freight-related issues, development of freight mobility project prioritization criteria, compilation of previously identified freight projects, and research on freight street design considerations.

The second phase of the Plan began in July 2004. In this phase, a set of technical analyses of needs and deficiencies, and identified solutions in the form of policy revisions, infrastructure improvements, and implementation activities was completed. The supporting technical documentation for the Freight Master Plan is contained in a series of technical memoranda prepared by staff with support from a consultant team. The technical memoranda covered the following subjects:

- *Innovations & Trends Report* explores the array of innovations and trends in the transport of freight and highlights communities that are using creative approaches to address freight mobility issues.
- *Synthesis of Data Report* summarizes and compiles the data used to complete the Existing Conditions and Assessment of Needs reports.
- *Existing Conditions Report* provides the most current analyses of performance, regulations and policy that govern freight mobility in Portland, including origin and destination patterns, trip demand by all freight modes, distribution of truck volumes, congestion points, and other physical and regulatory impediments.
- *Needs Assessment Report* presents analyses of existing and future year (2020) system-wide freight conditions including mobility, policy, programmatic, and regulatory issues.
- *Solutions and Strategies Report* presents recommendations for addressing freight's existing and future mobility needs and issues.
- *Freight Performance Measures and Indices Report* proposes measures and indices to evaluate how the City's transportation system is performing for freight's movement.
- *Freight Coordination within the Portland Office of Transportation Report* outlines a process for accomplishing the implementation activities identified in the Plan.

Public involvement for the Plan's development began in February 2003 as a conversation between the City Commissioner in charge of Transportation, representatives from the freight community, and other public agency staff interested in freight mobility. This group evolved into the Portland Freight Committee, an advisory group on freight transportation issues. The committee includes a diverse mix of representatives from the transportation and logistic industry as well as participation from the federal, state, regional, and City agencies that oversee freight mobility issues. The Portland Freight Committee served as the steering committee for the Freight Master Plan's development, providing guidance on Plan objectives, system needs, and priorities. A Technical Advisory Committee comprised of key Portland Office of Transportation engineering and planning staff, Oregon Department of Transportation, Metro, and the project consultant guided the technical analysis.

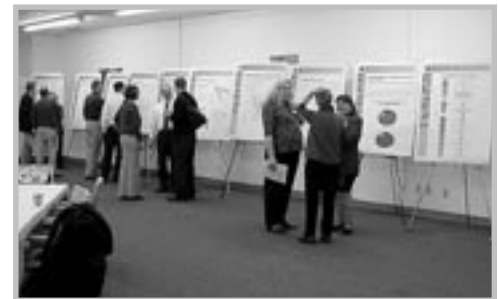
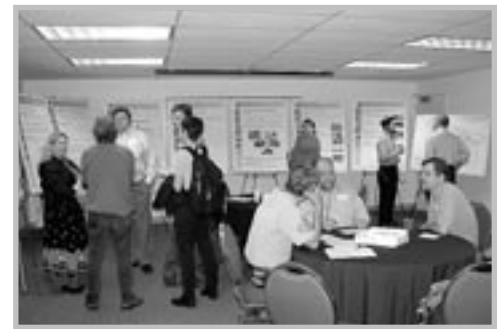



Opportunities for broad community input were provided in the form of three community open houses held at key points in the Plan's formulation. The open houses were designed to share information and gather input used to craft the Plan. Additionally, staff made numerous presentations to interested community groups and advisory committees. A listing of these presentations is provided in Appendix D.

The Freight Master Plan web page serves as an important public communication tool. The page provides general information about the planning process and notice of upcoming community meetings. Downloadable versions of the technical reports are available. The "Virtual Open House" section allows citizens who missed the public events access to the presentation materials, providing the opportunity to review and comment electronically.

## **Organization of Document**

The Freight Master Plan is organized around five major elements: freight-related policies and objectives, freight system classifications, implementation actions and strategies, freight system infrastructure improvements, and design guidelines for trucks.

Chapter Two summarizes the assessment of freight system needs and the Plan's approach for addressing the needs.

Chapter Three includes a summary of the freight-related Comprehensive Plan policies and classification map for the freight system.

Chapter Four describes the implementing actions and strategies for managing the movement goods in the community and how successful implementation is measure.

Chapter Five lists the freight infrastructure improvements.

Chapter Six focuses on planning for trucks in the right-of-way by providing a summary of the design guidelines for trucks.

Appendices include Comprehensive Plan policies, a detailed infrastructure improvements list, and a discussion paper on transportation funding sources for freight, a description of the public involvement process, and references used in the Plan's development.

## **RELATIONSHIP TO THE COMPREHENSIVE PLAN AND THE TRANSPORTATION SYSTEM PLAN**

Portland's Comprehensive Plan is the policy guide for city growth and development. The Transportation System Plan (TSP) is covered under the umbrella of the Comprehensive Plan. It serves as the City's public facility plan for transportation and it contains the transportation policies found in Goal 6, Transportation and Goal 11B, Public Rights-of-Way.

The Freight Master Plan is the base document for the freight element of the TSP. The Freight Master Plan is approved by City Council ordinance and functions as the detailed guide for the freight mode. Portions of the Freight Master Plan are also incorporated into the Comprehensive Plan and the TSP including:

- Changes to Comprehensive Plan policies

The Freight Master Plan includes revisions to Goal 5, Economic Development, Goal 6, Transportation, and Goal 11B, Public Rights-of-Way. Goal 6 includes both freight policies and classification maps.

- Changes to the Public Facilities Plan for Transportation

The Freight Master Plan infrastructure improvements list updates the current list of major system improvements for transportation.

- Changes to the Transportation System Plan

The Freight Master Plan informs future updates to the Truck and Air-Rail-Water-Pipeline modal plans and refines the performance measures used to monitor the function of the City's freight system.

## **COORDINATION WITH OTHER FREIGHT MOBILITY PLANS AND PROGRAMS**

The Portland Freight Master Plan has been prepared in coordination with other plans, programs and studies of freight mobility in the region. The Portland Planning Bureau and the Portland Development Commission have prepared the *Industrial Districts Atlas*<sup>6</sup> and the *Target Industrial Plan for the Distribution and Logistics Industries*<sup>7</sup>, respectively, which identify the current land uses and employment in the City's industrial districts, and make projections of the potential future growth of these districts.

The Port of Portland has produced essential data and plans for its marine terminals, airports, and overall ground transportation needs,<sup>8</sup> which have been incorporated fully into the Freight Master Plan. Moreover, the Port's information for the *Columbia River Channel Deepening Project*<sup>9</sup> and the *Commodity Flow Forecast Update/Lower Columbia River Cargo Forecast*<sup>10</sup> have provided fundamental data for the current and future products that flow into and out of the region, and the modes that will be used to move them.

Metro's Emme2 model output provided transportation data on truck volume and level-of-service during PM peak periods that was used to refine the truck street network.

Finally, the Oregon and Washington departments of transportation have produced the *I-5 Rail Capacity Study*,<sup>11</sup> and the working data and proposals for the *Columbia River Crossing*<sup>12</sup> project (formerly known as the "I-5 Trade and Transportation Corridor"), which have provided the regional level data on the major highway and railroad freight routes through Portland.

In 2006, Metro is anticipated to begin its Regional Freight Plan which is intended to develop projects and guidance that support freight mobility, and the Columbia River Crossing Project is anticipated to complete discrete analysis of freight conditions in the I-5 Corridor between Portland, OR and Vancouver, WA.

---

<sup>6</sup> *Industrial Districts Atlas*, Portland, OR 2004, Portland Bureau of Planning, 2005, [www.portlandonline.com/planning](http://www.portlandonline.com/planning)

<sup>7</sup> *Target Industry Plan: Distribution and Logistics*, Portland Development Commission 2004, [http://www.pdc.us/bus\\_serv/target\\_industries/distribution.asp](http://www.pdc.us/bus_serv/target_industries/distribution.asp)

<sup>8</sup> Including the Port's *2020 Marine Terminals Master Plan* (2004), the Portland International Airport Master Plan (2000), and the Port of Portland Transportation Improvement Plan (2005), all of which can be viewed at: [http://www.portofportland.com/POP\\_home.aspx](http://www.portofportland.com/POP_home.aspx)

<sup>9</sup> *Columbia River Channel Deepening Project*, Port of Portland, ongoing. [http://www.portofportland.com/ch\\_home.aspx](http://www.portofportland.com/ch_home.aspx)

<sup>10</sup> *Commodity Flow Forecast Update/Lower Columbia River Cargo Forecast*, Port of Portland, 2002, [http://www.portofportland.com/PDFPOP/Trade\\_Trans\\_Studies\\_LCR\\_Cmdty\\_Flw\\_Rpt.pdf](http://www.portofportland.com/PDFPOP/Trade_Trans_Studies_LCR_Cmdty_Flw_Rpt.pdf)

<sup>11</sup> *I-5 Rail Capacity Study*, I-5 Trade and Transportation Corridor Partnership, 2003, <http://www.oregon.gov/ODOT/RAIL/capstudy.shtml>

<sup>12</sup> *Columbia River Crossing*, jointly sponsored by the Washington State Department of Transportation and the Oregon Department of Transportation, 2005, <http://www.columbiarivercrossing.org>

## INTRODUCTION

Historic investments in Portland's transportation infrastructure have contributed directly to its importance as a center for commerce in the region. Portland's transportation system is an economic engine for the state, moving both people and commerce by a variety of transport modes. Maintaining freight mobility within Portland is a key element in sustaining the vitality of the local, regional, and statewide economy.

Reliability and efficiency are measures of a well-functioning freight transportation system. A reliable system is predictable and dependable for businesses that plan freight movement in hours and minutes. An efficient system is cost effective in terms of time, energy consumption, and infrastructure needs.

When a system is unreliable and inefficient, it has real consequences for the economy and the community:

- Freight assets like trucks and trains become less productive.
- Businesses put more trucks on the road to meet customer needs.
- Costs increase when businesses have to warehouse inventory.
- Financial and operational pressure increases for companies competing in a competitive, global market.<sup>13</sup>

Understanding and improving freight transportation with these basic performance measures is imperative. Portland's freight system is owned and operated by a variety of public and private entities that are often interdependent. For example, private barge operators travel to the Port of Portland marine terminals to transfer cargo to privately owned steamship operators, rail companies and motor carriers. The Oregon Department of Transportation and the City of Portland manage the road network used by motor carriers to move freight to customers. Maintaining a well-functioning system in this dynamic environment depends on good coordination and partnership.

## ASSESSING THE FREIGHT SYSTEM

### Growth and Congestion in the Freight System

The region's travel forecast model estimates that between 2000 (base year) and 2020 (future year), the number of medium and heavy truck trips nearly double.<sup>14</sup> Not surprisingly, arterials that serve the Portland's industrial areas have the highest volume of medium and heavy truck trips today and in the future.

Along with the growth in truck movement, traffic congestion is also increasing on Portland's street system. Analysis of the travel forecast model data indicates that locations that experience peak hour vehicle congestion today will have increased levels of congestion in the future. The locations that demonstrate the greatest increases in travel delay for freight movement occur on roads approaching the Portland International Airport and surrounding industrial area, along the US 30 industrial corridor, and on all of the freeway corridors in the city.

<sup>13</sup> *Reliability: Critical to Freight Transportation*, Public Roads, November/December 2004.

<sup>14</sup> The Regional Travel Forecast Model defines medium truck as having two axles, less than six tires, and less than 40,000 lb GTW. Heavy truck is defined as having two or more axles, six or more tires, and a GTW over 40,000 lbs.



Evening rush hour on I-5.

Growth challenges are not confined to Portland's street system. The projected growth in freight moved by water, rail, and air is significant.<sup>15</sup>

- Air cargo is anticipated to increase at a rate of 5 to 9 percent per year over the next 15 years.
- Marine traffic is expected to grow by 7 percent per year between 2000 and 2020.
- Freight rail traffic increases by 3.5 to 4 percent per year.

According to recent technical studies, the Portland region's rail infrastructure contains critical bottlenecks along several main line segments and rail yards operated by Burlington Northern-Santa Fe and Union Pacific. The delays experienced on the local freight network are equivalent to those experienced in the nation's largest rail hub—Chicago—which has 3.7 times the freight train traffic and 42 times the passenger train traffic of Portland.<sup>16</sup> In addition, branch line rail operations to and from rail yards and intermodal terminals are also highly congested. Rail capacity and service is also impacted by the need to expand and redesign some rail yards in the region.



Truck detour at weight-limited MLK Jr. Blvd. Viaduct.

### Infrastructure Barriers to Freight Mobility

Congestion is not the only challenge facing freight mobility in Portland. Physical barriers due to inadequate infrastructure also hamper the efficient and reliable movement of freight in the city. Some of the more significant obstacles include:

#### Weight-Restricted Bridges

A number of bridges on truck routes in Portland are weight-restricted to a single-unit truck weight of 50,000 pounds and 80,000 pounds for a combination truck, and in some instances less than 80,000 pounds. Industry efficiencies have led to an increase in the size of trucks since these bridges were constructed. Modern-day truck weights routinely exceed the design weight of these aging facilities. The result is that over-weight trucks are detoured from direct routes, increasing fuel consumption and operating costs. There is also the potential for diversion of trucks to streets that are not intended for frequent truck trips.



Bertha Blvd. underpass at Capitol Hwy.

#### Bridges with Low Vertical Clearance

Also an issue are bridges with sub-standard clearance for trucks passing under them. The legal height for trucks operating on highways and city streets is 14 feet but many trucks operating by permit exceed this standard height. As many as 24 bridges in Portland have clearance between 14 feet and 17 feet, with most located on highways or priority truck routes. Like weight-restricted bridges, this barrier also results in detours from direct routes.

<sup>15</sup> *Commodity Flow Forecast Update and Lower Columbia River Cargo Forecast Final Report*, prepared for the Port of Portland, Metro, Oregon Department of Transportation, Port of Vancouver, Regional Transportation Council, prepared by DRI-WEFA, BST Associates, and Cambridge Systematics, Inc, June 30, 2002.

<sup>16</sup> *I-5 Rail Capacity Study*, prepared by HDR Engineering, Inc, February 2003, page 2-5.

### At-Grade Railroad Crossings

With the predictions of substantial increases in train traffic in the Pacific Northwest over the next twenty years, conflicts between train and truck traffic will likely rise. Safety at locations where roads and rails intersect has long been a concern. More recently, the concern has focused on longer delays. Crossings near intermodal facilities, ports, major rail yards, and classification and switching areas will experience higher volumes of train and truck traffic due to growth in domestic and foreign trade.<sup>17</sup> In Portland, most at-grade crossings are located in industrial areas. At some crossings, stopped delay time for trucks and other traffic can be as high as four hours in a 24-hour period creating congestion and increasing operating costs.

### Pavement Condition

Portland is facing a growing pavement maintenance backlog. Declining revenues and increasing costs have reduced the miles of city streets maintained on a regular basis. Between 1980 and 2004, the backlog has grown from 285 miles to 586 miles. Regular maintenance of pavement increases its longevity, extending the time before major reconstruction is needed.

Large trucks accelerate the deterioration of paved surfaces. With forecasts of increasing truck volumes, the pavement on Portland's streets will certainly be subjected to increased wear and tear. The result of poor pavement conditions is decreased fuel economy, increased vehicle operation and maintenance costs, and the potential for damaged cargo.<sup>18</sup>

### Lift and Swing Spans Over the Columbia River

A more unique freight barrier in the region is the misalignment of two adjacent bridge spans. Travel by river tow boats and barge vessels is complicated during high water periods by the indirect alignment of the high span of the Interstate Bridge and the swing span of the BNSF rail bridge over the Columbia river. Captains maneuver their vessels under the mid-section of the I-5 bridge to avoid I-5 bridge lifts that delay interstate traffic. Once clear of this bridge, captains maneuver their vessel to the northern river channel to clear the swing span of the rail bridge. During periods of high water, about six months of the year, this maneuver becomes far more difficult, increasing the potential for an accident.



At-grade railroad crossing in SE Portland.



Deteriorating pavement on N. Bradford.



I-5 bridge over the Columbia River, with the rail bridge in the distance.

<sup>17</sup> *Status of Nation's Highways, Bridges and Transit: 2002 Conditions and Performance Report to Congress*, U.S. Department of Transportation, Federal Highway Administration, Pg. 26-1.

<sup>18</sup> [www.transportationca.com](http://www.transportationca.com), Transportation California, April 28, 2004.



Hawthorne Boulevard in SE Portland.

### Road Design

Most of Portland has a mature arterial street system, designed to accommodate vehicle traffic of a former era. Today, many of the trucks that use these older streets to deliver goods and services to the community are much larger than the street design is intended to support. At times, the needs for efficient truck movement are in conflict with other desired design features on the same street such as median islands or curb extensions. In other cases, trucks benefit from a design feature such as bike lanes that provide more space for turns. Balancing the needs of the different truck types using the streets with the needs of other users presents a challenge, especially in mixed-use centers and along main streets.



On-street loading in downtown Portland.

### Parking and Loading

A critical element of the supply chain is the ability to efficiently transfer goods and materials between shippers, trucks, and customers. Portland provides commercial on-street loading zones along many of its streets. The zones are assigned by request from individuals who receive and/or make truck deliveries. Portland's zoning code has requirements for off-street loading spaces in commercial, employment and larger residential developments.

Anecdotal evidence suggests that the existing supply of and demand for loading spaces is mismatched. The result is that drivers either double-park in travel lanes, blocking traffic, or park illegally. Currently, there is no comprehensive method to ensure that on- and off-street loading is adequate to meet business needs.



Truck hauling over-dimensional load of construction equipment.

### Over-Dimensional Truckloads

Some loads carried by trucks are not practically divisible, meaning that they can not be reduced to meet legal limits for weight, height, length, and/or width set by the State of Oregon. The State requires that trucks exceeding legal dimensions obtain a permit when traveling on public roadways. Portland also regulates over-dimensional loads and writes permits based on criteria established in Title 16 of the City Code.

The most common type of over-dimensional load in Portland is construction equipment such as cranes and excavators but other manufactured items such as steel slabs and bridge girders require over-dimensional moves. These are an infrequent but an important type of freight movement in the city. There is a need to identify and maintain a primary network of over-dimensional routes, with a focus on connections in and between Freight Districts.

## **Industrial Lands and Freight**

Compared to other cities, Portland has a relatively large number of industrial parcels available for development. Portland has a natural advantage for firms seeking an industrial location adjacent to aviation, marine, rail and highway networks. However, analyses by Portland Development Commission and the Bureau of Planning found that demand for development-ready industrial land will outstrip supply. The challenge is that available industrial land has limitations to being readily developed, including:

- Lack of good access to the street and highway network.
- Environmental and ownership constraints.
- Many of the parcels are previously developed and are more expensive to redevelop.

## **A COURSE OF ACTION**

The Freight Master Plan will provide an overall strategy of investment and management of the City's transportation system including connections to other public and private facilities as a catalyst for improved mobility, livability and economic health. The Plan strives to achieve its goals in a way that is supportive of and consistent with the community's transportation values encapsulated in the Transportation System Plan including:

- Maintain a healthy economy and a thriving community.
- Manage transportation assets in a fiscally-responsible way to ensure the region's limited dollars are available for a wide range of solutions.
- Provide transportation choices.
- Look for ways to reduce environmental impacts of transportation.
- Emphasize coordination and partnership in planning the transportation system.

Investments in multimodal transportation infrastructure have historically contributed directly to Portland's importance as an economic center. But a changing global business environment means Portland must be more strategic to maintain its economic vitality and competitiveness. The closer the relationship between transportation investment and siting of industrial and commercial facilities, the greater the benefit to the overall economic health of the community. To accomplish this, Portland must be more deliberate in integrating economic development activities with land use and transportation planning for industrial sectors.

The Plan's implementation framework relies on a three-pronged approach of policy guidance, programmatic actions and strategies, and infrastructure improvements. The following chapters provide the details of how the Plan will achieve the City's freight mobility goals and objectives.





## INTRODUCTION

The City of Portland relies on its Comprehensive Plan to guide decision making for the City's future growth and development. The Plan contains a coordinated set of goals, policies and objectives that together set a direction for choices about programs, capital investments, and funding priorities.

- Goals are the broadest expression of a community's desire and aspirations for a particular focus area.
- Policies are statements that set a preferred course of direction.
- Objectives are specific actions that carry out the intent of the goal and policy.

The Comprehensive Plan goals relevant to freight movement include Goal 5, Economic Development, Goal 6, Transportation, and Goal 11B, Public Rights-of-Way. Following is a brief description of these goals.

Goal 5, Economic Development, promotes a multimodal transportation system that encourages economic development.

Goal 6, Transportation, provides overall guidance on how Portland's transportation system should function over the 20-year life of the Comprehensive Plan. The goal reflects the multiple functions of a balanced transportation system, which distributes transportation benefits and effects fairly across a diverse population of system users.

Goal 11B, Public Rights-of-Way meets the state of Oregon's requirements on jurisdictions to maintain public facility plans. Goal 11B policies and the Transportation System Plan project list comprise the public facility plan for transportation. The goal intends to improve the quality of Portland's transportation system by carrying out projects to implement the 2040 Growth Concept, preserving public rights-of-way, implementing street plans, continuing high-quality maintenance and improvement programs, and allocating limited resources to identified needs of neighborhoods and businesses.

## POLICY FRAMEWORK

Portland's Comprehensive Plan establishes policies for freight in the context of a larger regulatory framework of federal, state, and regional goals and policies. Portland's policies are required to be compatible with and complement the framework established at higher levels of governance.

### Intermodal Surface Transportation Act of 1991 (ISTEA)

Landmark federal transportation legislation that initiated national policy for the development of a national intermodal transportation system that is economically and energy-efficient and environmentally sound in the movement of people and goods.

### National Highway System (NHS)

Established under ISTEA legislation, the NHS is a 161,000 mile national network of interconnected roadways that link primary intermodal facilities including: airports, international border crossings, maritime ports, rail-truck terminals, intermodal passenger facilities, and major travel destinations. These roadways are the most critical connections in the national transportation network. In Oregon, the NHS is comprised of three classes of designation: Interstate Highway–NHS, State Highway–NHS, and NHS Intermodal Connectors, which are primarily attached to county-and city-owned roadways.

## **National Network**

The Surface Transportation Assistance Act (STAA) of 1982 requires states to allow larger vehicles on a national network of roadways comprised of the Interstate Highway System and non-Interstate Federal Aid Primary System. The act also specifies the legal limits for height, length, width, and weight of trucks using the National Network roadways. Jurisdictions are required to provide reasonable access for STAA legal-sized vehicles on their networks.

## **Oregon Statewide Planning Goal 12**

Statewide Planning Goal 12, Transportation is Oregon's policy umbrella for transportation planning at the state, regional, and local level. Goal 12 directs jurisdictions to "provide for and encourage a safe, convenient and economic transportation system." The goal states implementing directives that include: considering all transportation modes in planning; identifying system needs; avoiding reliance on a single mode of transportation; minimizing adverse impacts; conserving energy; meeting the needs of the transportation disadvantaged; and strengthening the economy by facilitating the flow of goods and services.

## **Transportation Planning Rule (TPR)**

The TPR is the implementing rule for Goal 12, Transportation. It establishes mandates for linking land uses and transportation planning activities including the identification of needs for movement of goods and services to support planned industrial and commercial development.

## **Oregon Transportation Plan (OTP)**

The OTP is the transportation system plan, providing guidance for policy and long-range planning for the multimodal transportation system. It directs that Oregon's transportation system be modally balanced, efficient, accessible, environmentally responsible, connect places and modes, safe, and financially sustainable. Specific to freight movement, Goal 3: Economic Development supports a balanced and efficient freight system, effective transportation links to markets, cooperation on expanding system capacity, and promotion of intermodal hubs.

## **Oregon Highway Plan (OHP)**

The OHP is a subset of the encompassing Oregon Transportation Plan. It focuses specifically on Oregon's state highway system and includes policies and objectives that direct how the system should function for freight. The plan also identifies a freight system network, which incorporates the National Highway System designations.

## **2040 Growth Concept and Regional Framework Plan**

The 2040 Growth Concept defines how the region should grow and develop over a 50-year planning horizon. The concept directs growth into higher density mixed-use centers and corridors supported by a multi-modal transportation system. Industrial areas are a primary component of the concept and are maintained as sanctuaries for long-term industrial activities. The Regional Framework Plan provides specific policies and guidelines for concept implementation.

## **Regional Transportation Plan (RTP)**

The RTP is the Portland metropolitan area's policy and investment guide for the multimodal transportation system. The plan recognizes the importance of a sound multimodal freight system to support the region's economic and livability goals. The RTP identifies and defines a regional freight system.

## **RELATIONSHIP TO PORTLAND'S TRANSPORTATION SYSTEM PLAN**

Portland's Transportation System Plan (TSP) is the 20-year guide for planning and investment in the multimodal transportation system. The TSP includes the Transportation Element of the Comprehensive Plan, consisting of Goal 6, Transportation and Goal 11B, Public Rights-of-Way policies and objectives.

The Freight Master Plan is a focused guide for managing freight activities. It details the specific policies, infrastructure needs, street design, and management actions that lead to an integrated and well-functioning freight transportation system. Through incorporation of freight policies and objectives, freight network map, and infrastructure improvements, this more detailed plan integrates into the TSP. Future updates to modal plans for trucks and air-rail-water-pipeline are informed by the Freight Master Plan.

As part of the TSP, implementation of the Freight Master Plan is combined and balanced with the needs of all transportation modes.

## **RELATIONSHIP TO OTHER CITY DOCUMENTS**

### **Community and Neighborhood Plans**

The City has numerous neighborhood and community plans with policies, strategies, and action items for improving local areas. Many of these plans specifically address freight. All existing neighborhood and community plans were reviewed for freight-related issues. Better management of truck activity in neighborhoods was the primary directive from these plans. Policy objectives and action items are addressed in the Freight Master Plan.

### **Portland Code and Charter**

#### **Title 16: Vehicles and Traffic**

**16.20.220, Truck Loading Zone** regulates truck loading zones. Truck loading zones are established to prevent double parking and other illegal parking by designating a supply of parking spaces dedicated to the delivery of merchandise by trucks to commercial properties. The regulations specify the types of vehicles that may park in a truck loading zone, the duration (30 minutes), frequency and where the truck loading zone should be located in relation to an intersection for traffic safety reasons.

**16.20.530, Temporary Truck Loading Area Permit** regulates the issuance of a temporary truck loading permit to any person proving a need for the permit. The temporary truck loading area must be designated by portable signs or parking meter hoods or as otherwise designated by the administrative instructions of the permit.

**16.70.600, Over Dimensional Vehicles** generally prohibits the driving or movement of vehicles of excessive weight; those dragging a log, pole, or other thing; and a vehicle that is constructed or loaded so as to allow its contents to drop, sift, leak or escape, among other general prohibitions. The section defines exemptions to the general prohibitions, which include the operation of government vehicles and vehicles permitted by the Traffic Engineer.

**16.70.630, Permits** stipulates permitted use of over-dimensional vehicles.

**16.70.640 Limits of Authority to Issue Variance Permit** defines the circumstances for which an over-dimensional permit may not be issued.

#### **Title 18: Noise Control**

**18.10.020, Motor Vehicles** regulates excessive noise from motor vehicles including trucks. Section B (3) specifically prohibits the use of a dynamic braking device on trucks over 10,000 GCWR within any residential zone of the City or within 200 feet of residences, school, hospital, or library, expect to avoid imminent danger.

### **Title 33: Planning and Zoning Code**

**33.266.310, Loading Standards** specifies the minimum number of loading spaces required to ensure adequate loading areas for larger uses and developments. The regulations ensure that access to and from loading facilities will not have a negative effect on the traffic safety or other transportation functions of the abutting right-of-way. The section regulates the number of loading spaces based on land use and specifies where the regulations apply. It also regulates loading space size, their placement, setback and landscaping. Regulations state that the design of a facility allows vehicles to enter and exit the site in a forward motion, except in the Central City plan district.

**33.130.255, Trucks and Equipment** regulates parking and storage of trucks and equipment to ensure that it will be consistent with the desired character of the commercial zones and to limit adverse effects on adjacent residential lands. The section sets truck and equipment parking standards for business vehicles (light, medium and heavy trucks) that park regularly at a site.

**Section 33.140.250, Trucks and Equipment** regulates truck and equipment parking for business vehicles that park regularly at a site. The regulations do not apply to pick-up and delivery activities, the use of vehicles during construction or other intermittent, short-term activities. The regulations differentiate between light and medium trucks and heavy trucks.

## **COMPREHENSIVE PLAN POLICIES FOR FREIGHT**

Goals, policies and objectives are the common link between the Freight Master Plan and the Comprehensive Plan. Development of the Freight Master Plan identified revisions to policies to better address freight movement needs and impacts. Following is a summary of policies and objectives that guide freight activity in Portland. Appendix A includes the complete text of the freight-related Comprehensive Plan policies.

### **Goal 5 Economic Development Policies**

Goal 5, Economic Development, promotes a multimodal transportation system that encourages economic development.

**Goal 5.4, Transportation System, Objectives A, B, and H** address the connection between the City's transportation system and economic development by enhancing the multimodal freight transportation system for competitive access to global markets, supporting development of industrial- and employment-zoned properties, and reinforcing the link between transportation investment and thriving industrial districts.

### **Goal 6 Transportation Policies**

Goal 6, Transportation, provides overall guidance on how Portland's transportation system should function. The goal reflects the multiple functions of a balanced transportation system, which addresses the needs of the many types of users. Many Goal 6 policies and objectives pertain directly to freight mobility including:

**Policy 6.3 Transportation Education, Objective B** supports a public-private partnership for implementing educational programs about freight movement in the City.

**Policy 6.9 Freight Classification Descriptions, Objectives A–I** describe the various elements of the City's Freight System including roadways, railways, freight districts, and freight facilities.

**Policy 6.13 Traffic Calming, Objective C** encourages vehicular traffic, including trucks, to use streets with higher classifications consistent with their function to avoid non-local traffic from infiltrating residential neighborhoods.

**Policy 6.15 Transportation System Management, Objective B** directs the City to give preference to projects that add system capacity through operational improvements such as signal upgrades, ITS, and intersection design that benefit all modes of transportation.

**Policy 6.29 Multimodal Freight System, Objectives A–E** supports the development of a safe, reliable, and efficient freight system that includes truck, rail, air, marine, and pipeline transport modes. The objectives emphasize public-private coordination and partnership in planning, prioritizing and funding freight infrastructure improvements. They also stress the need to work cooperatively to minimize adverse impacts caused by freight movement.

**Policy 6.30 Truck Mobility, Objectives A–G** provides guidance for developing, maintaining and managing the street network that supports truck movement. The objectives guide investment priorities, design for legal and over-dimensional loads, appropriate use of streets by trucks, and operational improvements to reduce delay.

**Policy 6.XX Truck Accessibility, Objective A–F** addresses truck access and circulation needs through objectives that focus on such actions as eliminating bridge weight and height restrictions, improving at-grade rail crossings to limit delay and increase safety, managing on-street loading zones for efficient loading and unloading, and considering truck needs in street design.

**Policies 6.34–6.40, Transportation District Policies and Objectives** detail and clarify issues and needs specific to a Transportation District. There are eight transportation districts in Portland—North, Northeast, Far Northeast, Northwest, Southeast, Far Southeast, Southwest, and Central City—many of which have policy and objectives that address freight mobility.

### **Goal 11B Public Rights-of Way**

Goal 11B policies and objectives are intended to improve the quality of Portland’s transportation system by guiding project development to implement the 2040 Growth Concept, preserve public rights-of-way, implement street plans, continue high-quality maintenance and improvement programs, and allocate limited resources to identified needs of neighborhoods, commerce and industry.

**Policy 11.10 Street Design and Right-of-Way Improvements, Objective E** directs the City to use the collection of right-of-way design resources including the Design Guide for Trucks (in progress) when developing and designing street improvements.

## **THE FREIGHT SYSTEM**

Portland relies on a multimodal classification system to describe the design and function of a street or other transportation facility. There are seven classification categories: Traffic, Transit, Pedestrian, Bicycle, Freight, Emergency Response, and Street Design. When funding, designing, or operating a facility all modal classifications are considered.

Portland’s freight system is comprised of streets, rail lines, and freight facilities including marine terminals, intermodal rail yards, airports, and pipeline terminals. Policy 6.9 describes each of the freight system classifications in the hierarchy. The classifications correspond to land use activities. For classifying network features, freight movement is divided into two broad categories: industrial-serving and commercial delivery of goods and services.

Industrial-serving freight moves by a combination of modes – truck, rail, air, pipeline, and marine vessel. Origins and destinations for this type of movement are primarily in Portland’s industrial sanctuaries. Efficient and reliable access to terminal facilities and the regional/interstate freight network is paramount for this category of freight. High truck volumes and tractor-trailer activity characterize industrial-serving freight movement.

Commercial goods and services delivery relies largely on trucks. This category of truck movement has varied origins and destinations, which can be industrial, commercial or residential. Truck size varies depending on the type of delivery or service. Efficient circulation and access between distribution centers and customer locations is important.

Table 3.1 describes the type of freight movement and land uses that correspond to the freight classifications.

**Table 3  
Freight Classifications by Activity Type**

FREIGHT CLASSIFICATION	PRIMARY ACTIVITY			Land Use Connection
	Heavy Freight	Goods Delivery	Services	
<b>Regional Truckway</b>	●	●	●	Routes for interregional and interstate movement of freight. Serves both industrial and commercial land uses via access ramps.
<b>Priority Truck Street</b>	●	○	○	Principal route for truck mobility in Freight Districts, and between Freight Districts, and Regional Truckways. Provides truck access and circulation to industrial and employment land uses.
<b>Major Truck Street</b>	●	●	●	Principal route for truck mobility between commercial centers and corridors. Provides truck access and circulation to regional main streets.
<b>Truck Access Street</b>	○	●	●	Route for distribution of truck trips in neighborhoods. Provides truck access and circulation for delivery of goods and services to commercial and residential uses.
<b>Local Truck Street</b>	○	●	●	Routes for local truck access and circulation to residents and businesses outside of the freight districts.
<b>Freight District</b>	●	○	○	Freight districts are determined by the presence of industrial sanctuary zoning (IG1, IG2 & IH). Streets within a Freight District provide local truck circulation and access. Applies to all streets unless classified with a higher designation.
<b>Railroad Main Lines</b>	●	○	○	Transports freight cargo and passengers over long distances as part of a national rail network.
<b>Railroad Branch Lines</b>	●	○	○	Transports Freight cargo over short distances or distributes it to and from railroad main lines.
<b>Freight Facilities</b>	●	○	○	The major marine terminals, airport, railyards, and intermodal facilities located in Freight Districts.

● Primary Activity    ● Secondary Activity    ○ Limited Activity

### Mapping the Freight System

Figure 6 Recommended Freight Network displays Portland’s freight system including the highway and street network, rail network, and major freight facilities. The mapped network, in combination with the classification descriptions, is part of Goal 6 of the Comprehensive Plan.

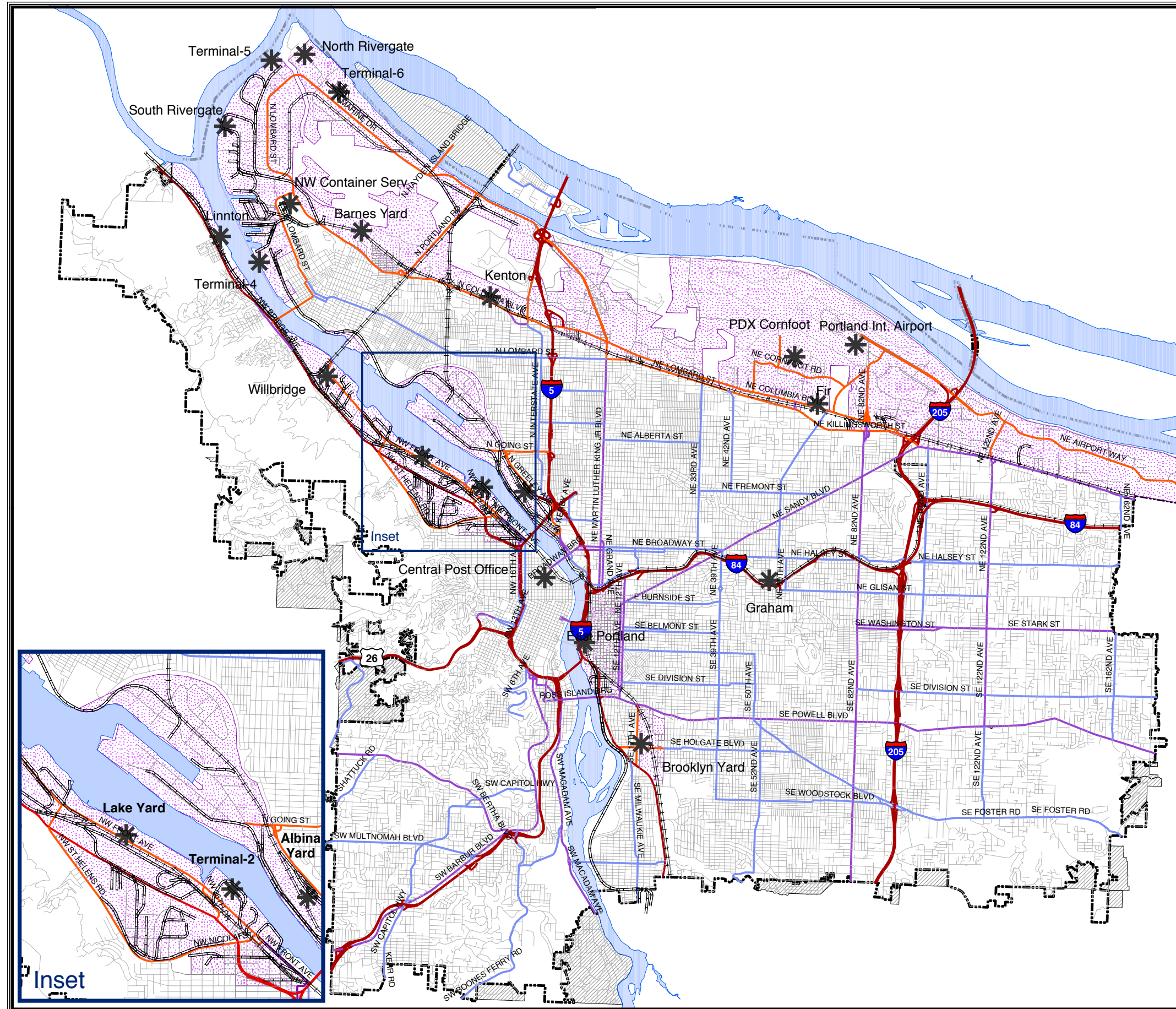

**Figure 8**  
**RECOMMENDED FREIGHT NETWORK**

**Freight Classifications**

- Regional Truck Way
- Priority Truck Street
- Major Truck Street
- Truck Access Street
- Freight District Street
- Local Service Truck Street
- Main Rail Line
- Branch Rail
- Freight Facilities
- Freight District
- Urban Service Area



FREIGHT MASTER PLAN (9/9/05)





## INTRODUCTION

Success of the Plan's goals, policies, and objectives depends upon effective implementation and monitoring of progress. The combination of engineering, education, and enforcement strategies described in Chapters 4 and 5 are intended to enhance the movement of freight in Portland.

This chapter describes the follow-up actions and on-going activities to manage goods movement in the community. Chapter 5, Freight System Improvements, lists the infrastructure improvements that address freight network deficiencies. Together, these chapters provide a complete strategy for achieving the City's freight policies and objectives.

Many of the implementation actions, activities, and capital improvements described in this plan require coordination and partnership with other City bureaus such as the Planning Bureau and Portland Development Commission and with regional agencies including the Oregon Department of Transportation, METRO, the Port of Portland, and Multnomah County. Some may require endorsement and support from the private sector, while others require the involvement of neighborhood and business associations.

## ACTIONS AND ACTIVITIES

The three themes of the Plan—Mobility, Livability, and Healthy Economy—provide the framework for organizing the follow-up actions and on-going activities.

### Mobility

The mobility theme focuses on improving reliability and efficiency on the network of roads, railroads, rivers, and runways that move freight in Portland. Following are the actions and activities targeted at freight mobility:

- Coordinate with Metro and the Oregon Department of Transportation (ODOT) to develop a strategy for the transfer of US 30 Bypass designation to N. Columbia Boulevard in North Portland. The strategy will identify improvements to Columbia Boulevard to better meet the needs of over-dimensional truck movement.
- Identify a strategy for truck routes that serve the movement of over-dimensional loads throughout the City. Coordinate this effort with the existing Continuous Operations Variance Permit program activities.
- Develop a local street plan for the Northwest Industrial District to address access and circulation issues.
- Designate freight classifications for Central City sub-districts including Downtown, Lloyd District, Pearl District, South Waterfront, and Central Eastside streets as part of the Central City Transportation Management Plan update.
- Implement Intelligent Transportation System projects to manage congestion on key truck routes in order to provide better information about traffic delays and improved signal operation to control flow of traffic for certain situations.
- Coordinate with ODOT to provide truck-only queue lanes at freeway ramps in freight districts. Investigate the use of different ramp meter timing for truck-only lanes.
- Investigate implementation of exclusive trucks lanes including use of high-occupancy vehicle (HOV) lanes by trucks when not in use for HOV traffic.
- Optimize signal timing in freight corridors including Columbia Boulevard, Airport Way, Powell Boulevard, and McLoughlin Boulevard.
- Work in partnership with ODOT and private rail service providers to improve crossing protection safety and reduce at-grade rail crossing delays for trucks and trains. Strategies include construction of grade-separated rail crossings at key

locations, consolidation and/or elimination of at-grade rail crossings, and deployment of ITS communication system technology to provide real-time information about traffic delays due to train activity.

- Coordinate with the Columbia River Crossing Draft Environmental Impact Statement (DEIS) process on the evaluation of freight mobility issues in this segment of the I-5 Trade Corridor.
- Institute transportation demand management strategies in Freight Districts to provide travel options that help reduce single-occupancy vehicle use and increase street capacity for trucks.
- Support other freight modes such as rail or short sea shipping as alternatives to moving freight by truck.
- Initiate a North Willamette River Crossing Study to assess the feasibility of new bridge between Rivergate and US 30.
- Develop a freight mobility web page that provides up-to-date information on City truck routes, advisories about construction detours and work zones, over-dimensional permits and routing, and general information about the City's freight system management.

## **Livability**

The livability theme looks at ways to manage the aspects of freight movement that impact a community's quality of life. Following are the actions and activities that address livability:

- Work with local businesses and the Oregon Trucking Association to establish "good neighbor agreements" to address truck delivery issues including circulation plans and delivery schedules.
- Coordinate with the Portland Police Bureau through programs like Strategic and Focused Enforcement (SAFE) to identify opportunities for improving truck safety, education, and enforcement.
- Complete and implement the Portland Design Guide for Trucks.
- Develop and implement a signage program to direct trucks to appropriate routes.
- Evaluate and update on-street and off-street truck loading regulations and operations.
- Use the Transportation Safety and Livability Hotline as a tool to monitor neighborhood conflicts with freight movement. Work with the stakeholders to resolve neighborhood conflicts as they arise.
- Implement Share the Road, a public education program to distribute information about the characteristics and operational needs of the various transportation modes to improve safety on City streets.
- Partner with railroad operators and ODOT to institute "Quiet Zones" to reduce train whistle noise and improve track safety.
- Support efforts to foster environmentally-friendly goods movement practices such as the use of cleaner fuels and the reduction of truck and train idling.
- Monitor and enforce over-dimensional truck activity through the Continuous Operations Variance Permit Program (COVP).

## **Healthy Economy**

Promoting a multimodal transportation system that stimulates and supports long-term economic development and business investment is the focus of the healthy economy theme. Following are the actions and activities targeted at building and maintaining a healthy economy:

- Identify and improve site-specific-obstacles to access and circulation in Freight Districts.
- Collaborate with agency partners on public investment strategies to stimulate economic development associated with freight movement and the industries that rely on the efficient movement of freight.
- Partner with Portland Development Commission and Port of Portland to identify and implement transportation improvements that enhance marketability of industrial opportunity sites.
- Work with businesses in centers and along main streets to address truck access and loading issues.
- Identify and prioritize pavement maintenance needs in industrial areas.
- Participate in the development of workforce strategies for freight service providers.

## **MOVING AHEAD**

A plan is only as successful as the time and effort given to supporting its realization. Responsibility for carrying out the actions, activities, and projects identified in the Plan is spread across a number of work units in the Portland Office of Transportation. The Office of Transportation's Freight Coordinator will manage the implementation of the plan in coordination with these various work units.

Moreover, the City of Portland will continue to work closely with its agency partners to better address regional freight mobility. Partners include the Oregon Department of Transportation, Metro, Port of Portland, Multnomah County, Washington State Department of Transportation, SW Regional Transportation Council, and the other local cities, counties, and service districts within the Portland/Vancouver region.

Additionally, the City's advisory committee on freight mobility matters – the Portland Freight Committee – continues to be an important forum for discussing the City's freight issues and providing advice to City leaders and staff on all topics related to improving freight movement.

## **MONITORING SUCCESS**

An important component to any plan is the establishment of methods for measuring progress in achieving the plan goals and objectives. Performance measures have great value in technical assessment of change over time, evaluation of planned improvements, and as a tool for communication about the state of the system. The City uses performance measures to monitor its achievements and progress toward goals for transportation system performance and in meeting the transportation needs of its citizens. The City's TSP already includes several performance measures applicable to truck mobility. The Freight Master Plan enhances these existing performance measures and augments them with additional measures.

Table 4 lists both the established TSP measures and additional recommended measures. Refinement of the performance measures, development of baseline data, and on-going reporting of the data will occur as part of plan implementation.

**Table 4**  
**Freight System Performance Measures**

<b>Source</b>	<b>Measure</b>	<b>Description</b>
TSP	Hours of truck delay in the PM Peak and Mid-day	Tracks delay as a result of congested roadways. The current baseline data compares hours of truck delay for the entire City street system with regional delay. Enhancements to current measures include truck delay at key intersections and along freight corridors, and distinguishing between causes of congestion by re-occurring vs. non-reoccurring events. Intersections and truck streets should be selected based on their direct accessibility to freight terminals and transfer facilities.
TSP	Travel time in ITS Corridors for average PM Peak, AM Peak, and Off-peak	Evaluates the travel time performance in corridors using ITS technology to manage system operations. Expand the current selection of corridors to include those critical for freight movement including Rivergate, Airport Way, Columbia Blvd, US 30, and interstate freeways in Portland. Track travel time for truck trips in addition to auto trips, as is current practice.
TSP	Assessment of unmet pavement need	Tracks success in reducing pavement maintenance backlog. Assess and report on pavement condition in Freight Districts and along major freight corridors.
TSP	Employee participation in Transportation Management Associations (TMA)	Tracks progress in expanding the use of and participation in TMA programs to encourage use of alternatives to the single-occupancy vehicle for work commute trips.
TSP	Annual truck collisions/million vehicle miles of travel	Measures the number of reported collisions that involved trucks and other modes, including rail, as reported for all City locations.
TSP	Elimination of weight-restricted bridges on truck streets	Tracks progress in rehabilitating or replacing weight-restricted bridges.
TSP	Assessment of truck compliant resolution	Evaluates the number of freight-related complaints received by PDOT and status of resolution.

## INTRODUCTION

Over the last decade, many area plans and corridor studies have identified needed freight infrastructure improvements in the City. The set of freight infrastructure improvements described in this chapter draw from multiple sources including:

- Portland Transportation System Plan
- Regional Transportation Plan
- Port of Portland Transportation Improvement Plan
- I-5 Rail Capacity Study
- I-5 Trade Corridor Study
- Central Eastside Transportation Study
- Columbia Corridor Transportation Study
- St. Johns Truck Strategy
- South Portland Circulation Study
- Intelligent Transportation System Implementation Plan
- Freight Master Plan technical analysis and community input

## WHAT IS A FREIGHT IMPROVEMENT?

An infrastructure improvement is deemed “freight-related” if it meets the following criteria:

- Improves a freight route of significance, as defined by a Transportation System Plan, Regional Transportation Plan, Oregon Highway Plan, and/or National Highway System freight route designation or is located on or improves access to properties zoned for industrial or employment land uses.
- Includes project elements that improves or facilitates freight movement.
- Demonstrates consistency with state, regional, and local transportation policies.

## TYPES OF FREIGHT IMPROVEMENTS

The freight infrastructure improvements included in the plan are presented in six categories:

- **HIGHWAY**  
Infrastructure improvements on Portland’s freeway system such as interchange upgrades and auxiliary lanes.
- **STREET**  
Infrastructure improvements on Portland’s arterial street system such as intersection upgrades, access management, and new road connections.
- **SYSTEM MANAGEMENT**  
Installation of Intelligent Transportation System infrastructure such as closed circuit TV cameras and variable message signs to provide real-time information to dispatchers and truck drivers.
- **BRIDGE**  
Upgrading load-limits, improving clearances, seismic upgrades, and new structures.

- **RAIL**

Infrastructure improvements, such as signalization upgrades, bypass tracks, and high-speed turnouts, to improve rail capacity and reduce bottlenecks.

- **MARINE**

Infrastructure improvements, such as longer berths, channel dredging, and adequate bridge clearances, to upgrade river operations and marine terminal facilities.

## **SETTING INFRASTRUCTURE PRIORITIES**

All of the infrastructure improvements presented later in this chapter meet an identified need. However, finite resources for funding and implementing transportation projects require that priorities be set to direct limited resources to gain the greatest value for the dollar spent.

### **Priority Tiers**

The freight infrastructure improvements are classified into four priority tiers by improvement category.

The four tiers include:

- **Funded** – Projects with identified partial or full funding, an indication that the project is advancing towards implementation in the near term.
- **Tier 1** – Near-term advancement for funding and implementation, within five years.
- **Tier 2** – Mid-term advancement for funding and implementation, within ten years.
- **Tier 3** – Long-term advancement for funding and implementation, within twenty years.

### **Project Priority and Selection Criteria**

The criteria used to develop priorities are shown in Table 5. Improvements with the highest priority demonstrate the following characteristics:

- Benefits multiple modes of freight transportation and may have benefits for non-freight modes, particularly transit, bicycles, and pedestrians.
- Benefits a key freight corridor by improving system reliability, safety and/or access.
- Improves access to freight facilities.

The criteria was applied to the infrastructure improvements listed under Highway, Street, System Management and Bridge categories to establish relative priority in each category. Priority for Rail and Marine improvements have been established in other planning efforts.

## **FREIGHT INFRASTRUCTURE IMPROVEMENTS**

The following pages identify Portland's freight infrastructure improvements by category and include a location map. The list of improvements is inclusive of the needs identified to date. Future improvements may be added as additional needs are uncovered through further evaluation and study of freight movement.

Many of the infrastructure improvements identified here will require further study, more neighborhood input, and additional City Council review prior to construction. As further evaluations are made of the projects in this Plan, the projects may be modified.

Appendix B includes the list of infrastructure improvements with detailed descriptions and estimated costs.

**Table 5  
Prioritization Criteria for Highway and Street Infrastructure Improvements for Freight**

Criteria	Score	Rating
<b>Policy Metrics</b>		
Will this project benefit multimodal freight transportation movement?	High, Medium, or Low	Freight modes include trucks, rail, air, marine, pipeline <ul style="list-style-type: none"> <li>• Low – benefits one mode</li> <li>• Medium – benefits 2 modes</li> <li>• High – benefits 3 or more freight modes</li> </ul>
Is this project located on freight routes of significance?	High, Medium, or Low	<ul style="list-style-type: none"> <li>• Low – Portland freight system only</li> <li>• Medium – Portland and Regional freight system</li> <li>• High – all the above plus Oregon Highway Plan and National Highway System</li> </ul>
<b>Operational Metrics</b>		
Will this project improve reliability on the freight system?	High or Low	<ul style="list-style-type: none"> <li>• Low – Minimal or no impact on system reliability</li> <li>• High – Improves freight travel time in a corridor through operation improvements, or removes a system bottleneck, or improves a congested intersection/roadway</li> </ul>
Will this project improve freight system connectivity?	High or Low	<ul style="list-style-type: none"> <li>• Low – Minimal or no impact on system connectivity</li> <li>• High – Removes barriers such as load limits, clearance restrictions, or improves street connectivity</li> </ul>
Will this project improve safety on the freight system?	High or Low	<ul style="list-style-type: none"> <li>• Low – Minimal or no impact on system safety</li> <li>• High – Reduces vehicle/rail conflicts, reduces risk of catastrophic failure, improves intersection turn movements at high accident locations</li> </ul>
Will this project improve access to the airport, marine terminals or intermodal rail facilities?	High or Low	Does this project improve primary access to airport, marine terminals, or intermodal facilities? <ul style="list-style-type: none"> <li>• Low – No</li> <li>• High – Yes</li> </ul>
<b>Public Benefit Metrics</b>		
Will this project contribute to improved air quality?	High or Low	<ul style="list-style-type: none"> <li>• Low – Does not reduce idling or travel time</li> <li>• High – Reduces idling or travel time</li> </ul>
Will this project also benefit transit, walking, bicycling?	High, Medium, or Low	<ul style="list-style-type: none"> <li>• Low – Benefits 1 alternative mode</li> <li>• Medium – Benefits 2 alternative modes</li> <li>• High – Benefits 3 or more alternative modes</li> </ul>

# HIGHWAY

**Figure 9  
Highway Improvements**

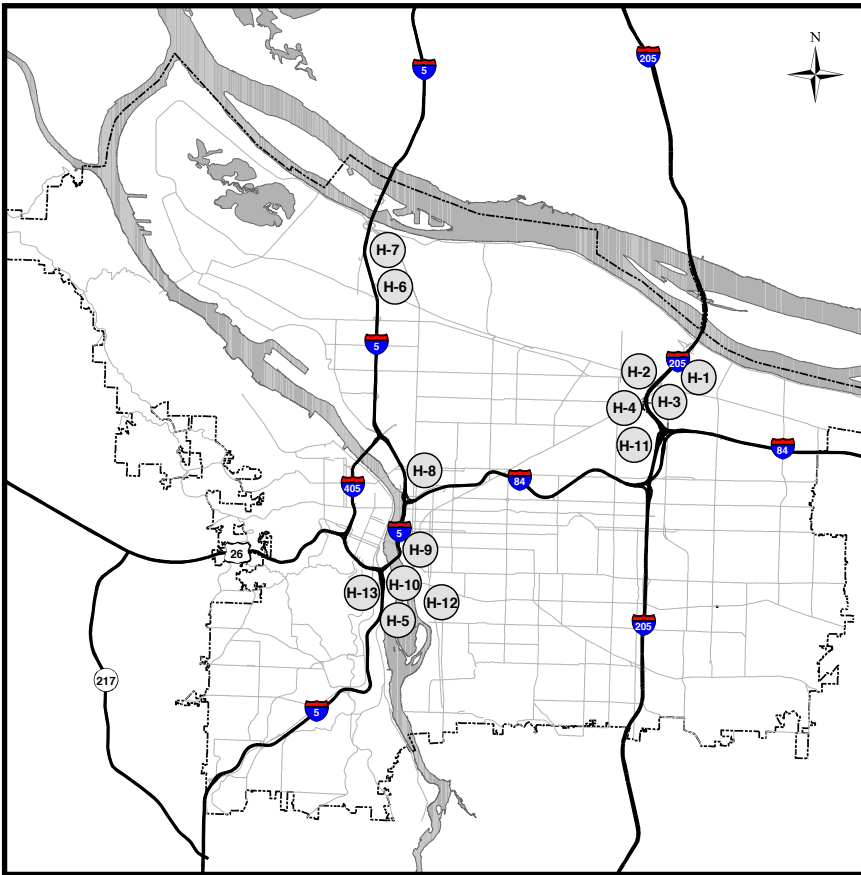

## Funded

Map ID	Project Name
H7	I-5, N (Expo Center - Lombard): Widening Freeway
H10	I-5/North Macadam Access Improvements, SW

## Tier 1

Map ID	Project Name
H6	I-5, N (at Columbia Blvd): Interchange Improvements
H8	I-5, N (Lloyd District/Rose Quarter): Reconstruction and Widening

## Tier 2

Map ID	Project Name
H3	I-205, NE (I-205/Airport Way) Interchange Improvement at NB On-ramp
H4	I-205, NE (I-205/Airport Way) Interchange Improvement at SB Off-ramp
H5	I-405/US 26/Ross Island Bridge, SW: Access Improvements
H13	Ross Island Bridge Interchange, SW

## Tier 3

Map ID	Project Name
H1	Airport Way, NE: Braided Ramps
H2	I-205 ,NE (Columbia Blvd - Airport Way): Auxiliary Lane
H9	I-5/ McLoughlin, SE: Construct Access Ramps
H11	I-84/I-205, NE: Auxiliary Lane
H12	McLoughlin (99E), SE (Ross Island Bridge - Clatsop): Multi-modal Improvements



# STREET – NORTH AND NORTHWEST PORTLAND

**Figure 10**  
Street Improvements - N & NW Portland

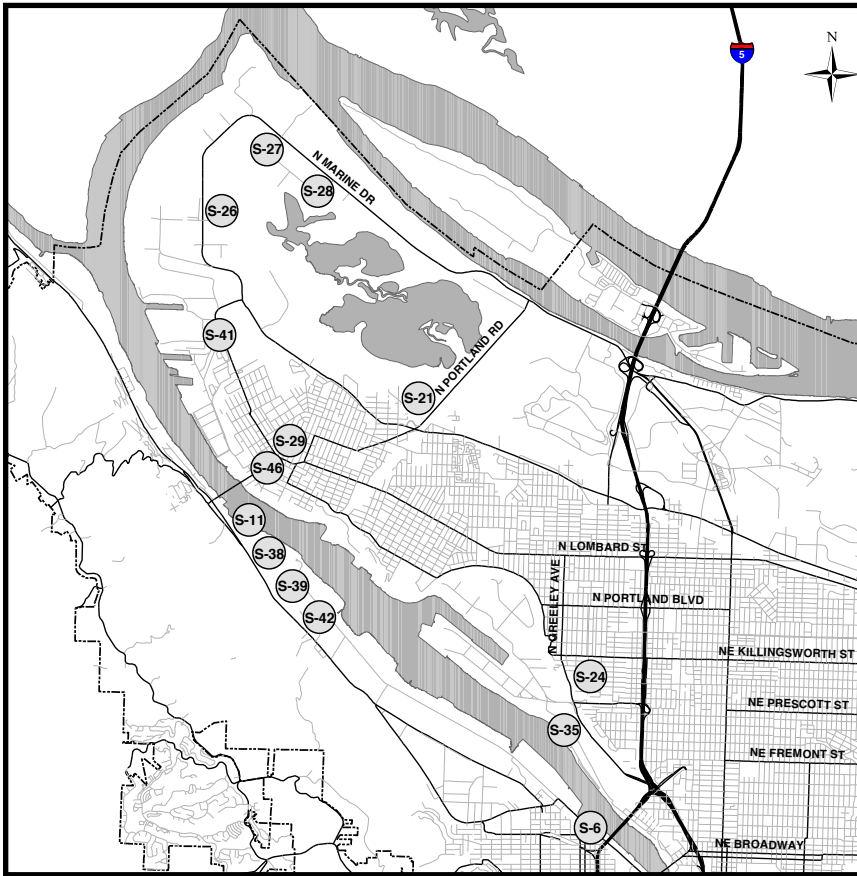

## Funded

Map ID	Project Name
S27	Leadbetter, N (Marine Dr Loop): Street Extension/Overcrossing
S28	Lombard, N (Rivergate - T-6): Multi-modal Improvements
S29	Lombard/St. Louis/Ivanhoe Multimodal Improvements, N
S41	Terminal 4 Driveway Consolidation
S42	US 30 at Lake Yard Hub Facility, NW: Access Improvements

## Tier 1

Map ID	Project Name
S26	Heineman, N: Road Connection
S21	Columbia Blvd/Portland Rd, N: Intersection Improvements
S24	Going/Greeley, N: Climbing Lane and Interchange Improvements
S38	St Helens Rd (US 30), NW, (in Willbridge area): Traffic Improvements

## Tier 2

Map ID	Project Name
S11	112th Ave/US 30, NW: Intersection Improvements
S35	River Ave, N (Port Center Way - River Ave): Street Extension
S39	St. Helens Rd (US 30), NW (at Saltzman & Balboa): Intersection Realignment

## Tier 3

Map ID	Project Name
S6	14/16th Connections, NW
S46	Ivanhoe/Philadelphia, N: Intersection Improvements

# STREET – NORTHEAST PORTLAND

Figure 11  
Street Improvements - NE Portland

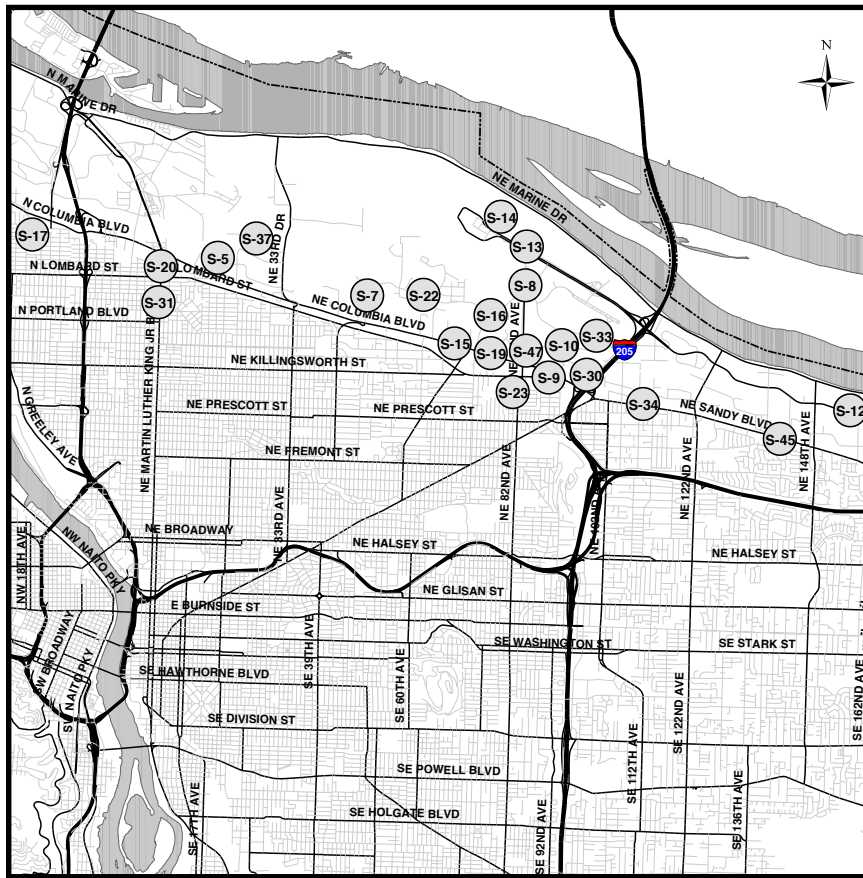

## Funded

Map ID	Project Name
S7	47th, NE (Columbia - Cornfoot): Roadway & Intersection Improvements
S8	82nd Ave/Alderwood Rd, NE: Intersection Improvements
S22	Cornfoot, NE (47th-Alderwood): Road Widening & Intersection Improvements
S23	East End Connector, NE
S47	82nd/Columbia, NE: Intersection Improvements

## Tier 1

Map ID	Project Name
S5	11th/13th, NE (at Columbia Blvd): Roadway Connector
S9	87th/Columbia, NE: Intersection Improvement
S15	Alderwood/Columbia Blvd/Cully, NE: Intersection Improvements
S16	Alderwood/Cornfoot Road, NE: Intersection Improvement
S20	Columbia Blvd/MLK Jr & Lombard/MLK Jr, NE: Intersection Improvements
S33	Mt St Helens Ave, NE (Cascades Parkway – Alderwood Rd): Street Extension

## Tier 2

Map ID	Project Name
S10	92nd Ave, NE, (Alderwood - Columbia Bl): Street Improvements
S13	Airport Way, NE (82nd - PDX Terminal): Street Widening
S14	Airport Way, NE: Access Road
S19	Columbia Blvd, NE (60th - 82nd): Road Widening
S30	Marx Dr, NE (82nd-87th): Street Extension
S31	MLK Jr, NE (Columbia - Lombard): Widen Street
S37	Southwest Quad, NE (at 33rd): Access to PDX Properties

## Tier 3

Map ID	Project Name
S12	158th, NE (Columbia Slough - Sandy Bl): Street Improvements
S17	Argyle, NE (14th - MLK): Street Extension
S34	Parkrose Connectivity Improvements, NE
S36	Southern Triangle Circulation Improvements, SE
S45	Sandy Bl, NE (122nd - City Limits): Multimodal Improvements

# STREET – SOUTHEAST PORTLAND

**Figure 12**  
**Street Improvements - Central Eastside Portland**

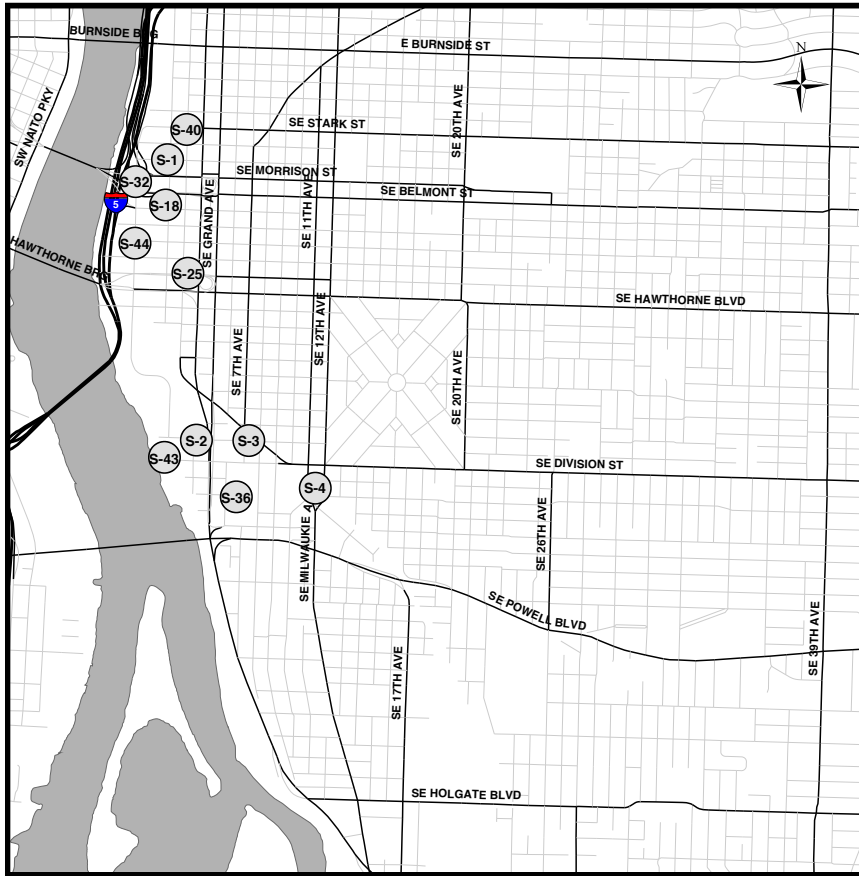

**Funded**

Map ID	Project Name
S32	Morrison Bridge at Water Ave Ramp, SE: Ramp Realignment

**Tier 1**

Map ID	Project Name
S2	4th Ave, SE (Caruthers – Ivon): Multi-modal Street Improvements
S3	7th/8th Ave, SE: New Street Connection
S25	Grand Ave, SE: Bridgehead Improvements
S43	Water Ave, SE (Caruthers – Division Pl): Street Extension Phase II

**Tier 2**

Map ID	Project Name
S4	11th/12th/Railroad Crossing, SE (West of Division): Intersection Improvements
S18	Belmont Ramp, SE (Eastside of Morrison Bridge): Ramp Reconstruction
S40	Stark St, SE (2nd - Grand): Safety & Capacity Improvements
S44	Water Ave, SE (Stark - Clay): Reconstruction

**Tier 3**

Map ID	Project Name
S1	1st Ave, SE (Stark - Clay): Railroad Mainline Access Improvements

# SYSTEM MANAGEMENT

**Figure 13**  
**System Management Improvements**

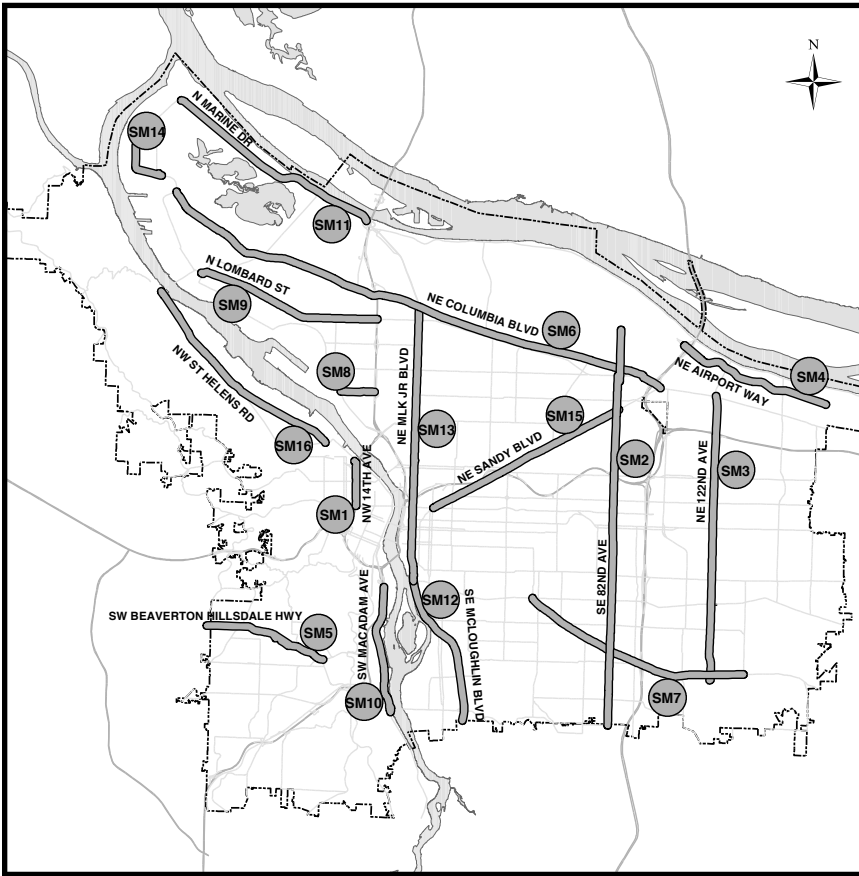

**Funded**

Map ID	Project Name
SM2	82nd, NE/SE: ITS

**Tier 1**

Map ID	Project Name
SM4	Airport Way, NE (I-205 - 158th): ITS
SM6	Columbia Blvd, N/NE(I-205 - Burgard): ITS
SM8	Going, N (Interstate - Greeley): ITS
SM14	Rivergate ITS, N
SM16	Yeon/St. Helens, NW: ITS

**Tier 2**

Map ID	Project Name
SM3	122nd, NE/SE (Airport Way - Powell): ITS
SM10	Macadam, SW (Bancroft - Sellwood Br): ITS
SM11	Marine Dr, N/NE (Portland Rd to 185th): ITS
SM12	McLoughlin, SE: ITS
SM13	MLK Jr, N (Columbia Bl - CEID): ITS
SM17	Powell Blvd, SE (Milwaukie – 122nd): ITS

**Tier 3**

Map ID	Project Name
SM1	14th/16th, NW/SW & 13th/14th, SW, Glisan - Clay: ITS, Clay to Glisan
SM5	Beaverton-Hillsdale Hwy, SW: ITS
SM7	Foster Rd, SE: ITS
SM9	Lombard, N/NE (MLK Jr - Philadelphia): ITS
SM15	Sandy Bl, NE (82nd - Burnside): ITS

# BRIDGE

**Figure 14**  
**Bridge Improvements**

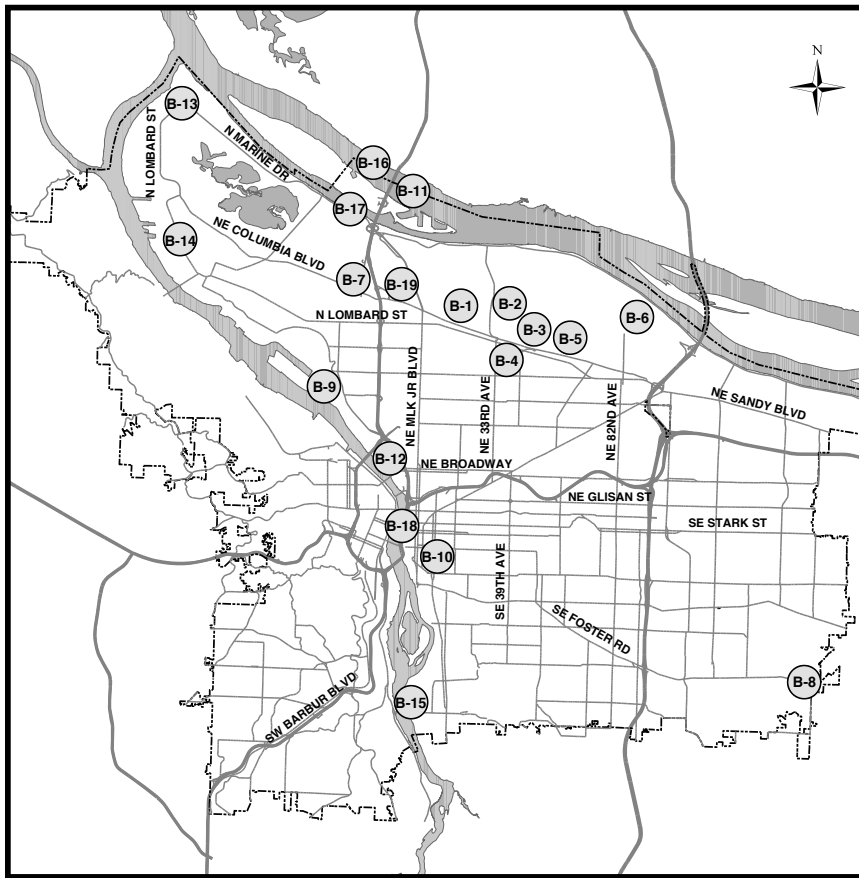

## Funded

Map ID	Project Name
B3	33rd, NE (at Columbia Slough): Bridge Replacement
B4	33rd, NE (at Lombard): Bridge Replacement
B8	Foster Rd, Bridge at Johnson Creek: Bridge Replacement
B9	Going St Bridge, N: Bridge Rehabilitation
B10	Grand/ MLK Jr Viaduct, SE: Reconstruct Viaduct
B11	I-5, N (Columbia River - Columbia Bl): Bridge Widening
B13	Lombard at Columbia Slough Overcrossing (Rivergate), N: Rehabilitation
B14	Lombard St. (Burgard), N: Bridge Replacement
B18	Willamette River Bridges, NE/NW/SE/SW: Rehabilitation for Broadway, Burnside, Morrison, and Sauvie Island (Phased improvement program)

## Tier 1

Map ID	Project Name
B7	Denver Viaduct, N: Reconstruct Viaduct (Identified as Phase 2)
B15	Sellwood Bridge, SE/SW: Bridge Replacement
B16	Vancouver BNSF Rail Bridge Project (Columbia River)
B19	Vancouver Bridge, N (at Columbia Slough): Bridge Replacement

## Tier 2

Map ID	Project Name
B1	21st, NE (at Columbia Slough): Bridge Replacement

## Tier 3

Map ID	Project Name
B2	33rd Ramps, NE, (at Columbia Bl/Lombard): New Ramps
B5	42nd Bridge, NE (at Lombard): Bridge Replacement
B6	82nd/Airport Way, NE: Overcrossing
B12	Interstate, N, Bridge at Larrabee: Bridge Rehabilitation
B17	West Hayden Crossing, N: New Bridge

# RAIL

**Figure 15**  
**Rail Improvements**

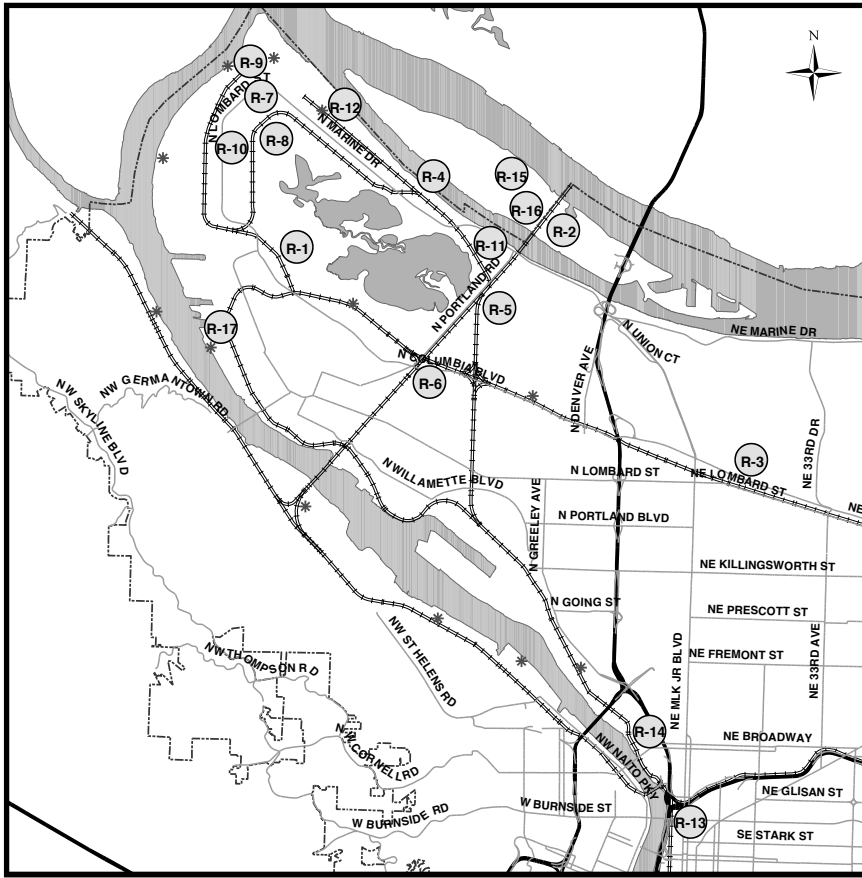

**Tier 1**

Map ID	Project Name
R7	Ramsey Rail Complex, N (south of Columbia Slough Bridge): Capacity Improvements
R8	Rivergate Rail Yard Expansion, N
R10	T-5 Unit Rail Loops #3 & #4
R11	T-6 Intermodal Third Lead
R16	West Hayden Island/Rivergate, N: Rail Access
R17	Barnes to Terminal 4, N: Truck Expansion

**Tier 2**

Map ID	Project Name
R1	Barnes Rail Yard - Bonneville Rail Yard, N: Track Expansion
R2	BNSF Line @ Columbia Bridge, N: Track Improvements
R5	North Portland Junction, N: Rail Improvements
R6	Penn Junction, N, UP/BNSF Main Line: Track Realignment
R12	Terminal 6 A&B Yards
R13	UP Line Connection, SE (Brooklyn line - Graham line)
R14	UP Line Upgrade, SE (Albina Yard - East Portland)

**Tier 3**

Map ID	Project Name
R3	Kenton Rail Line, NE: Additional RR Tracks
R4	Marine Dr, N (at Rivergate West): Rail Crossing, Phase II
R9	Slough Rail Bridge, N
R15	West Hayden Island Rail Yard Expansion, West Hayden Island

# MARINE

**Figure 16**  
**Marine Improvements**

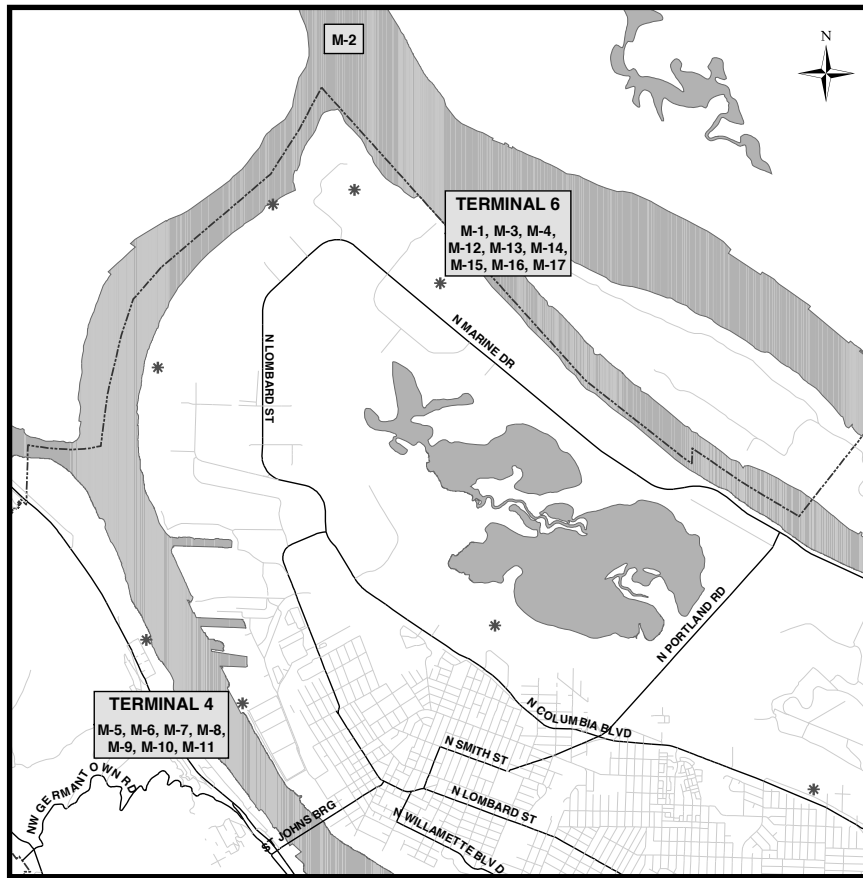

### Funded

Map ID	Project Name
M2	Columbia River Channel Deepening - Regional Share, N/NE
M3	Container Crane - Terminal 6
M4	Honda Facility Upgrade, N
M10	Terminal 4 Pier 2 Rail Yard Improvements, N
M13	Terminal 6 Berth Deepening
M14	Terminal 6 Computer System Upgrades, N

### Tier 1

Map ID	Project Name
M1	Access Tunnel at Hyundai/Kia Facility, N
M5	Hyundai Auto Terminal Expansion, N
M6	Mar Com North Facility, N
M7	Optional Terminal Lower Lot Access, N
M8	Terminal 4 Grain Elevator Barge Conveyor Rebuild, N
M9	Terminal 4 On-site Overcrossing, N
M15	Terminal 6 Container Dock Extension, N

### Tier 2

Map ID	Project Name
M11	Terminal 4, N: Access Improvements
M16	Terminal 6 Dock Structural Upgrades, N

### Tier 3

Map ID	Project Name
M12	Terminal 6 Additional Post-Panamax Cranes, N
M17	Terminal 6 - Marine Dr, N: Overcrossing

## **FUNDING THE FREIGHT SYSTEM**

Appendix C includes an in depth discussion of the federal, state, regional and local transportation financing options for freight infrastructure improvements.



## INTRODUCTION

Successful implementation of the freight mobility improvements and policies for trucks described in this document are based on the expectation that appropriate and consistent design practices are used for safe and convenient truck travel on city streets. Planning and designing for truck circulation and access is essential for all environments and districts in the city.

Streets within industrial areas as well as those that provide direct connections between industrial areas and the regional freeway system need to fully accommodate truck movements without impeding their mobility. In mixed-use areas, lane widths and corner radii may be narrowed to compel trucks to travel more slowly in order to provide a streetscape that supports significant pedestrian travel. In residential areas, all vehicle travel is limited to slower speeds, and streets in these areas are intended for local truck deliveries. Accommodating truck travel in these and other environments requires careful design practices that balance the needs of all users of the street.

This chapter provides a general overview of street design for trucks. *The Portland Design Guide for Trucks*, a companion document to the Freight Master Plan, is an in-depth look at street design and trucks.

## PLANNING FOR TRUCKS IN THE RIGHT-OF-WAY

Trucks come in many shapes and sizes, dictated by the goods or materials being hauled and the distance that the goods travel. The American Association of State Highway and Transportation Officials (AASHTO) have developed a classification system that identifies trucks by their approximate overall vehicle height, width, and length. This classification ranges from the SU-30 Single Unit truck (e.g., cement trucks, large rental trucks, local delivery trucks) up to the WB-67 Interstate truck (large semi-trailer with sleeper cab equipped tractor; this class also includes double and triple trailer combinations). Figure 15 shows the typical dimensions of the AASHTO standard vehicles referenced in these guidelines, and Table 6 lists the specific characteristics of each vehicle type. Additional information on these and other design vehicles can be found in the AASHTO “Policy on Geometric Design of Highways and Streets”.<sup>19</sup>

While procedural guidance can be developed to provide general direction for design of intersections for trucks, the final configuration and best overall design of an intersection must still be completed by experienced designers. Basic geometric considerations, such as the angle at which the roads intersect, the presence of buildings abutting the right of way, and use of right-turn lanes will vary from intersection to intersection. Moreover, the surrounding land use, existing development, and many other factors could influence specific decisions about intersection design.

**Figure 17**  
**Dimensions of Typical Design Vehicles**

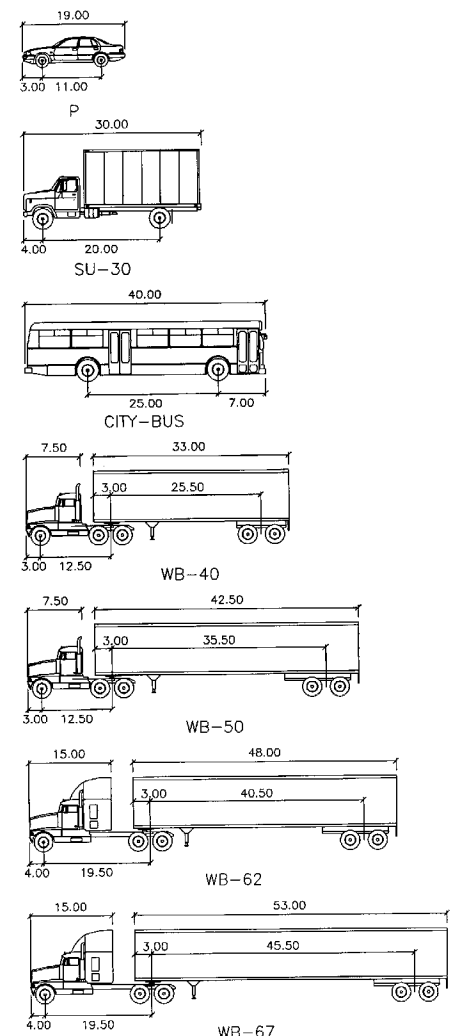

<sup>19</sup> *Policy on Geometric Design of Highways and Streets*, American Association of State Highway and Transportation Officials, 2004.

**Table 6**  
**Truck Design Vehicle Characteristics and Turning Movement Information**

Design Vehicles	Symbol	Trailer	Wheelbase	Overall Length	Minimum Design Turning Radius	Truck Widths* (without mirrors)	Minimum Inside Radius**
Automobile	P	none	11'	19'	24'	na	14.4'
Bus	Bus	none	25'	40'	42'	8.5'	24.5'
Signal Unit Truck	SU-30	none	20'	30'	42'	8.5'	28.3'
Intermediate Semi -Trailer	WB-40	33' trailer	40'	45'	40'	8.5'	19.3'
Intermediate Semi -Trailer	WB-50	42.5' trailer	50'	55'	45'	8.5'	17.0'
Intermediate Semi -Trailer	WB-62	48' trailer	62'	68.6'	45'	8.5'	7.9'
Intermediate Semi -Trailer	WB-67	53' trailer	65'	73.5'	45'	8.5'	4.4'

Source: AASHTO *A Policy on Geometric Design of Highways and Streets*, 2001, Fourth Edition.

\* Mirrors on trucks extend between 12" and 18" from the frame of the truck.

\*\* For a 180-degree turn.



Truck exiting T-6 in Rivergate Industrial District.

### Portland's Street Classification Designations

Streets within the City of Portland are designated by functional classifications on the basis of the traffic they are intended and expected to carry and the desired performance of traffic on those streets. With each designation comes a set of design principles to accomplish those functions. For example, Regional Truckways carry high volumes of intercity and interstate truck traffic on limited access highways with high speed limits, while Local Truck Streets are intended to accommodate local deliveries on streets with relatively slow travel speed limits.



Truck activity on N. Marine Dr.

### Trucks in Freight Districts

Priority Truck Streets and local streets in Freight Districts should be designed to provide for good truck mobility, access, and circulation. Because trucks measure about 10.5' wide (including side mirrors) it is important to provide adequate roadway lane width for a truck to travel without encroaching into an adjacent lane, where another vehicle could be struck or forced to take evasive action. In addition, most trucks require a minimum vertical clearance of at least 14' between the roadway and overhead fixed objects. In addition to lane width and vertical clearance, other items to consider when designing a corridor for high truck activity include corner and median island radii, location of signs, utility and signal poles, street trees, and other roadside items.

### Trucks in Mixed-Use Neighborhoods

Portland's mixed-use pedestrian and bicycle-friendly neighborhoods are hubs of activity hosting a variety of commercial and retail shops, restaurants, and residences and are referred to as "Centers" and "Main Streets". Common features that benefit pedestrians, such as narrow streets, curb extensions, and parked cars, are the toughest challenges for trucks and can impact the ability of trucks to maneuver, particularly compared to the streetscape provided in Freight Districts.

In most instances, deliveries to businesses in these locations can be completed with smaller trucks. Their compact size and tight turning radius make them suitable for narrow street geometries and local deliveries. Typical trucks include the SU-30 and WB-40 truck types. However, on occasion larger trucks, such as a WB-50 truck or a WB-67 truck, must circulate in a Center or Main Street area to make a delivery. The key design elements that need to be considered for the occasional large truck is intersection design.

Figure 18 illustrates how a WB-67 truck would negotiate a right-hand turn onto a 4-lane street with a 15' turning radius. Note that the truck has to position to the left and use as much space as possible to turn the trailer into the desired direction.

Figure 19 illustrates how a WB-67 truck completes a right-turn into a two-lane street. This is one of the most difficult street conditions a truck driver might face. Note how much of the on-street parking space the truck needs to complete the turn.

### Trucks in Residential Areas

Portland's residential neighborhoods are principally designed for automobile, pedestrian and bicycle movements, and very low volumes of truck activity. While occasional large delivery trucks and moving vans travel in these areas, the more common truck type is smaller-sized delivery trucks. The streets serving residential areas are classified for local truck deliveries, and they are not intended for through truck trips. Trucks in these areas travel at relatively slow speeds and trucks conduct loading from on-street or even residential driveway locations.

Lane widths on streets within residential areas are often relatively narrow and may feature on-street parking on one or both sides of the street. The combination of these elements leads to slow posted speeds (typically under 25 mph), and in many instances, traffic calming devices (such as raised center islands, landscaping treatments, rumble strips, and speed bumps) to reinforce the speed limits and improve pedestrian safety. The minimum width for streets in residential neighborhoods with parking on both sides is 32', but many streets are as narrow as 20'. Similar to Centers and Main Streets, truck movements are complicated by limited curb radii, narrow roadways, and often, parked vehicles near intersections.

**Figure 18**  
**Illustration of Large Truck at Four-Lane Intersection**

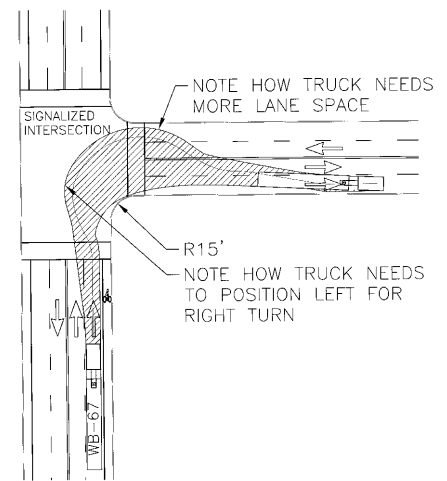

Right-hand turn by a WB-67 truck into a four-lane street with 15' curb radius.

**Figure 19**  
**Illustration of Large Truck at Two-Lane Intersection**

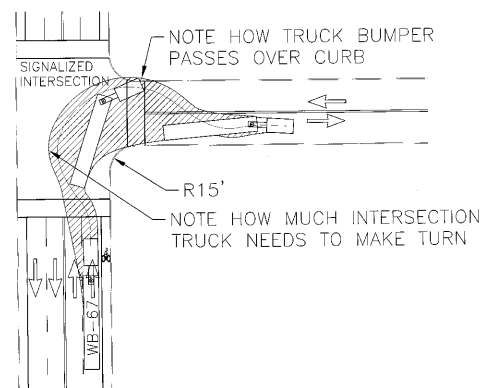

Right-hand turn by a WB-67 truck into a two-lane street with 15' curb radius.



Delivery trucks on Hawthorne.

## “DESIGN FOR” VERSUS “ACCOMMODATE” APPROACHES TO ADDRESSING TRUCK ACCESS

In the design of an intersection, it is essential to anticipate the type and size of trucks that will be accessing the intersection. Current and future use of adjacent property, roadway classification, truck route designation, and the need for a truck to turn at a particular intersection versus taking another more accessible route are some of the pertinent information needed to assess the level of truck activity.

With an understanding of the expected truck type, the designer evaluates the turning track maneuvers of a vehicle using AASHTO turning templates or specialized computer software such as AutoTURN,<sup>20</sup> including the path followed by the corners of the vehicle body or trailer, as well as the inside rear wheels. For a typical passenger vehicle, the path followed by the rear wheels is very nearly the same as that of the front wheels. With larger vehicles, the swept area becomes much larger as the inside rear wheels track substantially inside of the path of the front wheels. This becomes the most critical factor in sizing the intersection.

When developing designs to fully accommodate truck movements through an intersection, the designer establishes a travel path that allows the selected vehicle to remain entirely within its designated lane or lanes as it completes its turn. With respect to accommodating a truck in a tight street environment, the designer assumes more latitude for the vehicle path, including encroachment on adjacent lanes approaching and/or departing the intersection. (See Figure 18)

When seeking to accommodate larger vehicles in tight street environments, the designer often assumes a truck driver will shift to the left, hugging the lane line, before beginning a right turn, and will use all available lanes moving in their direction to begin and complete the turn.

**Figure 18**  
**Examples of “Design For” and “Accommodate”**

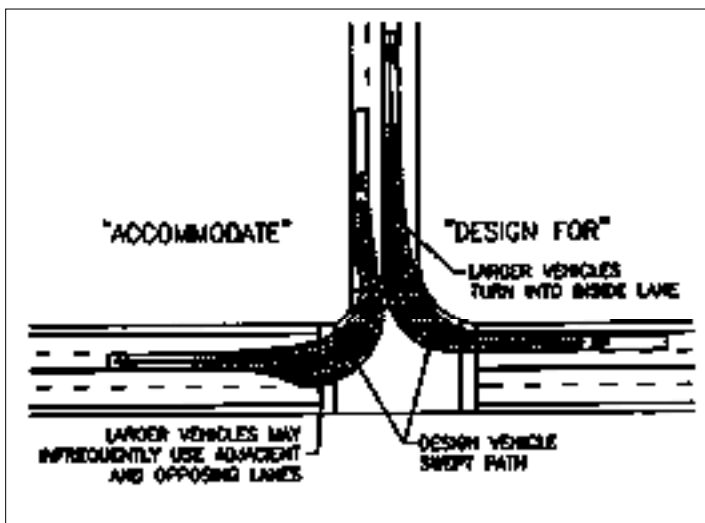

This is just one example of how a designer might accommodate truck movements in a low traffic volume situation.

This can produce interference with other traffic during the times when trucks are turning. This is sometimes referred to as “operational accommodation” since the compromise is some loss of operational efficiency of traffic movements. If this maneuvering by large trucks is infrequent or if the general traffic volume is low, the interference from the encroachment into adjacent lanes moving in the same direction as the trucks is considered acceptable.

If physical constraints, such as limited right of way, restrict the ability for all trucks to conveniently complete a turn, the designer may be forced to further compromise the intersection operation with regard to large trucks. At a minimum, the designer seeks to assure “physical accommodation” of large vehicles. In such cases, the designer tries to design the intersection such that there are no permanent physical features that prevent a large vehicle from negotiating a corner. For example, the designer could assume that the entire street width is available for truck maneuvering. This maneuvering may require that trucks use opposing travel

<sup>20</sup> AutoTURN is a registered trademark of Transoft Solutions.

lanes normally used by oncoming traffic, and could require pilot cars, flaggers, or permits. Designing for minimal truck circulation and access may not be a desirable condition; however, if truck traffic is infrequent and traffic volumes are low, it is a workable operation and would have little effect on an overall streetscape concept. In addition, the designer seeks to keep traffic signal poles, fire hydrants and other street features outside the obstruction free zone of a street corner so that in extreme cases, trucks might even drive over the curb to complete a turn.

### **Over-Dimensional Load Considerations**

Over-dimension variance permits are required by the Oregon Department of Transportation when truck width exceeds 8.5' (excluding side mirrors) or when truck height exceeds 14'. Pilot cars are required according to the segment of highway being traversed. On some highways, pilot cars may be required for loads as narrow as 9', but on other highways loads of 12' or even 14' may be permitted without pilot cars. The City's Continuous Operating Variance Permit Map provides guidance on designated pilot car routes.

The Manual on Uniform Traffic Control Devices (MUTCD) specifies that traffic signals be mounted with the bottom no less than 17' and no more than 19' above the pavement. In actual practice, some traffic signals in the Portland area fall outside these parameters. As indicated in the previous paragraph, trucks higher than 14' require permits, so that the placement of traffic signals, even those mounted lower than the standard specified in the MUTCD, do not interfere with regular loads. Since over-dimensional loads are an important form of freight, it is important to give these types of movements some consideration.

## **CONSIDERING TRUCKS IN DESIGN**

This section provides a list of design considerations and suggested design practices for accommodating trucks in Centers and Main Street areas for use by engineers, architects, designers, and planners involved in the design and planning of street design concepts, land developments, and streetscapes that require access by trucks.

### **Coordination with Street Classifications**

Streets in the City are classified according to their function in the transportation system. Higher-classified routes such as I-5 and US 26 carry high volumes of traffic over long distances, and have a significant number of larger vehicles. Lower-classified streets such as Neighborhood Collectors carry primarily passenger car traffic to and from residential areas. Policy language describes the desired function and design priorities for street classifications.

The 'design for' approach should be applied to Regional Truckways, Priority Truck Streets, Major Truck Streets, and in Freight Districts. The 'accommodate' approach should be applied to Truck Access Streets. In the case of Major Truck Streets, the 'design for' approach must be balanced with other street design considerations when these streets are also designated as City Walkways or located in Pedestrian Districts.

### **Plan for Trucks Early in the Process**

Truck circulation should be considered early in the conceptual development of street design, as well as in the conceptual stages of a land use development proposal. During street design, consideration should be given to the level of truck activity along a street and access to and from adjacent properties. Street characteristics such as lane width, area and design of existing intersections need to be evaluated for their suitability to the types of trucks that are needed for businesses in the area. This is particularly important in existing urbanized areas outside of Freight Districts where conflicts with trucks are more likely to occur. Other land uses in the area that use trucks should also be noted.

During the conceptual design/design development stages of street design and land use actions, trucks need to be carefully considered in the design of loading facilities. Access to loading facilities (on- or off- street) and to properties on those streets need to be considered.

## COMPREHENSIVE PLAN POLICIES FOR FREIGHT MOBILITY

Appendix A includes the Comprehensive Plan policy and objectives pertaining to freight mobility. Refer to the Comprehensive Plan or Transportation System Plan for the complete set of transportation policies and objectives. *An asterisk (\*) next to the policy or objective indicates that no changes to the current language have been proposed.*

### Goal 5 Economic Development

#### Goal 5.4, Transportation System\*

Promote a multimodal regional transportation system that stimulates and supports long term economic development and business investment.

##### Objective A

Support multimodal freight transportation improvements to provide competitive regional access to global markets and facilitate the efficient movement of goods and services in and out of Portland's major industrial and commercial districts. Ensure access to intermodal terminals and related distribution facilities to facilitate the local, national, and international distribution of goods and services.

##### Objective B

Use transportation system improvements as a catalyst for attracting industrial and employment development.

##### Objective H

Pursue transportation and parking improvements that reinforce commercial, industrial and residential districts and promote development of new districts.

### Goal 6 Transportation

#### Policy 6.3 Transportation Education\*

Implement educational programs that support a range of transportation choices and emphasize safety for all modes of travel.

##### Objective B\*

Implement educational programs that recognize the need for developing and maintaining a multimodal transportation system that supports the movement of freight as well as people.

#### Policy 6.9 Freight Classification Descriptions

Designate a system of truck streets, railroad lines, and intermodal freight facilities that support local, national, and international distribution of goods and services.

##### Objective A. Freight Districts

Freight Districts are intended to provide safe and convenient truck mobility and access in industrial and employment areas serving high levels of truck traffic and to accommodate the needs of intermodal freight movement.

- Land Use. Support locating industrial and employment land uses that rely on multimodal freight movement in Freight Districts.
- Function. Freight District streets provide local truck access and circulation to industrial and employment land uses.
- Connections. In Freight Districts, streets not classified as Regional Truckways or Priority Truck Streets are classified as Freight District streets. Freight District streets connect individual properties to Priority Truck Streets.
- Design. Freight District streets should be designed to facilitate the movement of all truck types and over-dimensional loads, as practicable.

### **Objective B. Regional Truckways**

Regional Truckways are intended to facilitate interregional and interstate movement of freight.

- Land Use. Support locating industrial and employment land uses with high levels of truck activity near Regional Truckway interchanges.
- Function. Provide for safe and efficient continuous-flow operation for trucks.
- Connection. Provide Regional Truckway interchanges that directly serve Freight Districts and connect to Priority Truck Streets and other streets with high levels of truck activity.
- Design. Design Regional Truckways to be limited access facilities and to standards that facilitate the movement of all truck types.

### **Objective C. Priority Truck Streets**

Priority Truck Streets are intended to serve as the primary route for access and circulation in Freight Districts, and between Freight Districts and Regional Truckways.

- Land Use. Support locating industrial and employment uses that generate high truck activity on corridors served by Priority Truck Streets.
- Function. Priority Truck Streets accommodate high truck volumes and provide high-quality mobility and access.
- Connections. Priority Truck Streets connect Freight Districts to Regional Truckways.
- Design. Priority Truck Streets should be designed to facilitate the movement of all truck classes and over-dimensional loads, as practicable. Buffer adjacent residential uses from noise impacts, where warranted.

### **Objective D. Major Truck Streets**

Major Truck Streets are intended to serve as principal routes for trucks in a Transportation District.

- Land Use. Commercial and employment land uses that generate high levels of truck activity should locate along Major Truck Streets.
- Function. Major Truck Streets provide truck mobility within a Transportation District and access to commercial and employment uses along the corridor.
- Connections. Major Truck Streets connect Transportation District-level truck trips to Regional Truckways. Trucks with no trip ends within a Transportation District should be discouraged from using Major Truck Streets.
- Design. Major Truck Streets should accommodate all truck types, as practicable.

### **Objective E. Truck Access Streets**

Truck Access Streets are intended to serve as an access and circulation route for delivery of goods and services to neighborhood-serving commercial and employment land uses.

- Land Use. Support locating commercial land uses that generate lower volumes of truck trips on Truck Access Streets.
- Function. Truck Access Streets should provide access and circulation to land uses within a Transportation District. Non-local truck trips are discouraged from using Truck Access Streets.
- Connections. Truck Access Streets should distribute truck trips from Major Truck Streets to neighborhood-serving destinations.
- Design. Design Truck Access Streets to accommodate truck needs in balance with other modal needs of the street.

### **Objective F. Local Service Truck Streets**

Local Service Truck Streets are intended to serve local truck circulation and access.

- Land Use. Local Service Truck Streets provide for goods and service delivery to individual commercial, employment, and residential locations outside of Freight Districts.
- Function. Local Service Truck Streets should provide local truck access and circulation only.
- Connections. All streets, outside of Freight Districts, not classified as Regional Truckways, Priority Truck Streets, Major Truck Streets, or Truck Access Streets are classified as Local Service Truck Streets. Local Service Truck Streets with a higher Traffic classification are the preferred routes for local access and circulation.
- Design. Local Service Truck Streets should give preference to accessing individual properties and the specific needs of property owners and residents along the street. Use of restrictive signage and operational accommodation are appropriate for Local Service Truck Streets.



### **Objective G. Railroad Main Lines**

Railroad Main Lines transport freight cargo and passengers over long distance as part of a railway network.

### **Objective H. Railroad Branch Lines**

Railroad Branch Lines transport freight cargo over short distances on local rail lines that are not part of a rail network and distribute cargo to and from main line railroads.

### **Objective I. Freight Facilities**

Freight Facilities include the major marine, air, rail, and pipeline terminals that facilitate the local, national and international movement of freight.

### **Policy 6.13 Traffic Calming\***

Manage traffic on Neighborhood Collectors and Local Traffic Streets, along main streets, and in centers consistent with their street classifications, classification descriptions, and desired land uses.

### **Objective C\*.**

Encourage non-local traffic, including trucks, to use streets of higher traffic and truck classification through design, operations, permitting, and signing.

### **Policy 6.15 Transportation System Management\***

Give preference to transportation improvements that use existing roadway capacity efficiently and improve the safety of the system.

### **Objective B.**

Employ transportation system management measures, including coordinating and synchronizing signals and intersection design, to improve mobility and safety for all modes.

### **Policy 6.29 Multimodal Freight System**

Develop and maintain a multimodal freight transportation system for the safe, reliable, and efficient movement of freight within and through the City.

*Explanation: The relationship between the movement of freight, goods and services is also addressed by objectives under Policy 5.4, Transportation System, of the Economic Development goal of the Comprehensive Plan.*

### **Objective A**

Support a well-integrated freight system that includes truck, rail, marine, air, and pipeline modes as vital to a healthy economy.

### **Objective B**

Coordinate with private and public stakeholders to identify improvement and funding strategies for multimodal freight mobility needs.

### **Objective C**

Participate with inter-jurisdictional partners in the development of corridor plans, master plans, and regional facility plans that impact freight mobility.

### **Objective D**

Address freight access and mobility needs when conducting multimodal transportation studies or designing transportation facilities.

### **Objective E**

Work with community stakeholders to minimize adverse impacts of freight activity on the environment and residential and mixed-use neighborhoods.

### **Policy 6.30 Truck Mobility**

Develop, manage, and maintain a safe, efficient, and reliable freight street network to serve Freight Districts, commercial areas, and neighborhoods.

*Explanation: This policy recognizes the City's role in managing truck movement on its street system.*

**Objective A**

Prioritize transportation investments in the freight street network that improve connections between Freight Districts and Regional Truckways.

**Objective B**

Accommodate truck travel on designated truck streets through improvements to facility design and operations that address the dimensional needs of trucks.

**Objective C**

Encourage through-truck traffic to use Regional Truckways, Priority Truck Streets, and Major Truck Streets for mobility and Truck Access Streets and Local Service Truck Streets to access local destinations.

**Objective D**

Develop and implement street connectivity plans for Freight Districts to improve truck circulation and access to industrial land uses.

**Objective E**

Develop and implement a signage plan for designated truck routes and major freight destinations.

**Objective F**

Designate and maintain preferred routes to accommodate over-dimensional freight movement.

**Objective G**

Employ intelligent transportation system measures to reduce delays and improve travel time on Regional Truckways, Priority Truck Streets and Major Truck Streets.

**Policy 6.XX Truck Accessibility**

Improve truck access to and from intermodal freight facilities, industrial and commercial districts, and the regional freight system.

**Objective A**

Evaluate and improve locations where inadequate roadway design creates barriers for truck access in Freight Districts and on designated truck streets.

**Objective B**

Upgrade bridges to remove load limits and vertical clearance restrictions on designated truck streets.

**Objective C**

Use public-private collaboration to identify and implement measures to minimize delays and improve safety at at-grade rail freight crossings.

**Objective D**

Provide adequate off-street loading areas for larger employment, commercial and multi-family developments.

**Objective E**

Manage supply, operations, and demand of on-street truck loading spaces to ensure efficient, reliable and safe loading and unloading activities.

**Objective F**

Implement design guidelines for truck streets that meet the dimensional needs of trucks, particularly for Freight Districts, while balancing the needs of other transportation modes in the right-of-way.

**Policy 6.34 North Transportation District\***

Reinforce neighborhood livability and commercial activity by planning and investing in a multimodal transportation network, relieving traffic congestion through measures that reduce transportation demand, and routing non-local and industrial traffic along the edges of the residential areas.

**Objective A\***

Improve truck and freight movement in North Portland through changes to the street system, street classifications, and signing to enhance the economic vitality of the area and minimize impacts on residential, commercial, and recreational areas.

**Objective B\***

Support the efficient functioning of the N Marine Drive/N Lombard Street (west of N Philadelphia)/N Columbia Boulevard loop as the truck and commuter access to the Rivergate industrial areas and adjacent industrial areas.

**Objective C\***

Direct industrial traffic onto N Columbia Boulevard, while allowing limited access from residential neighborhoods and mitigating for unacceptable traffic impacts.

**Objective D\***

Re-evaluate the need for a truck designation on N Argyle when improvements to the I-5/Columbia interchange are constructed or other improvements are made that make the N Argyle/Interstate truck connection redundant.

**Objective E\***

Work with the Federal Highway Commission and ODOT to remove the US 30 Bypass designation from Philadelphia and Lombard, west of Martin Luther King, Jr. Boulevard, and relocate it to more appropriate streets to minimize impacts on the St. Johns town center and the Lombard main street.

**Objective P**

Encourage the use of Columbia Boulevard as the primary route for over-dimensional truckloads while ensuring the role of N Lombard (west of Martin Luther King Jr. Boulevard) as an interim route until such time as improvements are completed that allow N Columbia to accommodate all types of over-dimensional truckloads.

**Policy 6.35 Northeast Transportation District**

Support the efficient use of land in Northeast Portland by focusing on development and redevelopment where there will be a reduction in reliance on the automobile.

**Objective A\***

Encourage automobile and truck through-traffic to use major arterials near the edges of the district to reduce peak-period traffic impacts and to preserve neighborhood livability.

**Objective I\***

Implement the projects recommended in the Columbia Corridor Transportation Study that improve vehicle and transit access, safety for all modes, and local connections.

**Objective J\***

Balance the needs of adjacent land uses (located in a design zone) at the NE Lombard and Martin Luther King Jr. Boulevard intersection with the need for truck movement.

**Policy 6.36 Far Northeast Transportation District\***

Support transportation choices by focusing transit and traffic movement on a well-defined system of arterials, implementing demand management measures, and encouraging walking and bicycling in the Far Northeast.

**Objective A\***

Enhance the arterial street system by improving connections between Neighborhood Collectors and District Collectors and eliminating bottlenecks, such as narrow rail viaducts, that contribute to intrusions into residential neighborhoods by commercial, industrial, and non-local traffic.

**Policy 6.37 Southeast Transportation District\***

Reduce travel demand and reliance on the automobile in Southeast Portland to protect residential areas and industrial sanctuaries from non-local traffic, while maintaining access to established commercial areas.

### **Objective G**

Encourage regional and interdistrict truck traffic to use Regional Truckways, Priority and Major Truck Streets in Southeast Portland by establishing convenient truck routing that better serves trucks, while protecting Southeast neighborhoods.

### **Objective O**

Address the safety and access needs of pedestrians and bicyclists as part of freight-related street improvements for SE Holgate between SE 26th Avenue and McLoughlin Boulevard.

*Explanation: SE Holgate is a Priority Freight Street that provides an important truck access function to the Brooklyn freight district. However, street improvement plans for SE Holgate developed for the purpose of facilitating freight movements should not overwhelm the other modal uses of the street, especially the safety and access needs of pedestrians and bicyclists.*

### **Policy 6.38 Far Southeast Transportation District\***

Address transportation issues in the Far Southeast District by encouraging the use of transit and demand management measures, improving pedestrian/bicycle access, creating a more connected street system, and improving the functioning of arterials.

### **Policy 6.39 Northwest Transportation District\***

Strengthen the multimodal transportation system in the Northwest District by increasing public transit use, encouraging transportation demand management measures, and improving pedestrian and bicycle access.

### **Objective B\***

Route non-local traffic, including non-local truck traffic, on Major City Traffic Streets and Regional Trafficways in order to minimize conflicts between modes.

### **Objective I\***

Improve access to NW 14th and 16th to support their function as connections to the commercial and industrial areas in Northwest Portland and to reduce impacts of non-local traffic on residential areas.

### **Objective L**

Preserve and enhance freight mobility, and industrial access in the Freight District, by maintaining or improving truck operations on Front Avenue, Yeon Avenue, Nicolai Street, St Helens Road, and the 14th and 16th Avenues couplet.

### **Policy 6.40 Southwest Transportation District\***

Address outstanding transportation issues in the Southwest District through studies and multimodal improvements, and use the transportation policy and objectives in the Southwest Community Plan to evaluate potential changes to the street system.

## **Goal 11B Public Rights-of Way**

### **Policy 11.10 Street Design and Right-of-Way Improvements\***

Design improvements to existing and new transportation facilities to implement transportation and land use goals and objectives.

### **Objective E**

Use a variety of transportation resources in developing and designing projects for all City streets, such as the City of Portland's Pedestrian Design Guide, Bicycle Master Plan-Appendix A, Design Guide for Truck Streets, and Design Guide for Public Street Improvements.

## APPENDIX B

## FREIGHT SYSTEM INFRASTRUCTURE IMPROVEMENTS

## HIGHWAY

H1	<b>Airport Way, NE: Braided Ramps</b>	<i>Construct braided ramps between the I-205 interchange and Cascade interchange to maintain capacity and improve safety on Airport Way and freeway interchanges.</i>	Est. Cost: \$30 M	Tier 3
H2	<b>I-205 ,NE (Columbia Blvd - Airport Way): Auxiliary Lane</b>	<i>New auxiliary lane on I-205 connecting Columbia Blvd and Airport Way ramps to reduce slowdowns and help improve safety for merging vehicles.</i>	Est. Cost: \$20 M	Tier 3
H3	<b>I-205, NE (I-205/Airport Way) Interchange Improvement at NB On-ramp</b>	<i>New I-205 NB on-ramp at Airport Way interchange to provide additional capacity for anticipated growth at interchange.</i>	Est. Cost: \$23 M	Tier 1
H4	<b>I-205, NE (I-205/Airport Way) Interchange Improvement at SB Off-ramp</b>	<i>Widen I-205 SB on-ramp at Airport Way interchange to provide additional capacity for anticipated growth at interchange.</i>	Est. Cost: \$550 K	Tier 2
H5	<b>I-405/US 26/Ross Island Bridge, SW: Access Improvements</b>	<i>Construct new freeway access from Ross Island Bridge to I-405 and US 26 to improve connections between regional facilities and separate traffic from neighborhood streets.</i>	Est. Cost: \$50 M	Tier 2
H6	<b>I-5, N (at Columbia Blvd): Interchange Improvements</b>	<i>Construct full direction access interchange based on recommendations from I-5: Delta Park to Lombard Environmental Assessment to improve connections between the Columbia Corridor industrial area and I-5.</i>	Est. Cost: \$56 M	Tier 1
H7	<b>I-5, N (Expo Center - Lombard): Widening Freeway</b>	<i>Widen I-5 to three lanes in each direction from Lombard to the Expo Center exit to improve safety and repair a system bottleneck.</i>	Est. Cost: \$41 M	Tier 1 - Funded
H8	<b>I-5, N (Lloyd District/Rose Quarter): Reconstruction and Widening</b>	<i>Modernize freeway and ramps between I-84 interchange and Fremont Bridge. Project improves safety, access to the Lloyd District and Rose Quarter, and reduces delay.</i>	Est. Cost: \$92 M	Tier 1

<b>H9</b>	<b>I-5/McLoughlin, SE: Construct Access Ramps</b>	<i>Construct new ramps from McLoughlin to I-5NB near Division to improve connections.</i>	Est. Cost: \$20M	Tier 3
<b>H10</b>	<b>I-5/North Macadam Access Improvements, SW</b>	<i>Construct new off-ramp at NB I-5 to NB Macadam Ave to add capacity and improve safety.</i>	Est. Cost: \$60.0 M	Funded
<b>H11</b>	<b>I-84/I-205, NE: Auxiliary Lane</b>	<i>New auxiliary lane from I-84 to I-205 NB before Columbia Blvd to reduce slowdowns and help improve safety for merging vehicles.</i>	Est. Cost: \$5 M	Tier 3
<b>H12</b>	<b>McLoughlin (99E), SE (Ross Island Bridge - Clatsop): Multi-modal Improvements</b>	<i>Provide access management, reversible travel lane from Ross Island Bridge to Harold, widen to six lanes from Harold to I-205 and construct pedestrian and bike facilities. Project reduces vehicle delay and improves corridor access for pedestrian and bicycles.</i>	Est. Cost: \$96.5 M	Tier 3
<b>H13</b>	<b>Ross Island Bridge Interchange, SW</b>	<i>US 26 Interchange improvement on east approach to Ross Island Bridge.</i>	Est. Cost: \$4.4 M	Tier 2

## STREET

<b>S1</b>	<b>1st Ave, SE (Stark - Clay): Railroad Mainline Access Improvements</b>	<i>Construct limited roadway access improvements, such as one-way vehicle circulation loops or loading zones, along the east side of the ROW adjacent to, but protected from, the railroad mainline.</i>	\$750 K	Tier 3
<b>S2</b>	<b>4th Ave, SE (Caruthers - Ivon): Multi-modal Street Improvements</b>	<i>Improve geometrically constrained 4th and Caruthers intersection to facilitate truck turning movements. Construct urban standard street improvements for traffic, and pedestrian and bike facilities connecting the Springwater Corridor to Caruthers.</i>	\$250 K	Tier 1
<b>S3</b>	<b>7th/8th Ave, SE: New Street Connection</b>	<i>Construct new street connection from SE 7th to 8th Avenue at Division Street to improve local street connectivity for industrial properties.</i>	\$500 K	Tier 1

<b>S4</b>	<b>11th/12th/Railroad Crossing, SE (West of Division): Intersection Improvements</b>	<i>Reconstruct intersection to upgrade traffic signalization and establish bike and ped routes to improve safety and reduce delay at intersection.</i>	\$400 K	Tier 2
<b>S5</b>	<b>11th/13th, NE (at Columbia Blvd): Roadway Connector</b>	<i>New three lane roadway and bridge over rail line to connect Lombard and Columbia. Provides space for double tracking of rail line. Improves freight mobility through additional rail capacity, new street connection, and grade separation.</i>	\$8 M	Tier 1
<b>S6</b>	<b>14/16th Connections, NW</b>	<i>Improve or create connections to W. Burnside, Yeon, and Vaughn and provide directional signage to route non-local traffic to 14th/16th couplet.</i>	\$200 K	Tier 3
<b>S7</b>	<b>47th, NE (Columbia - Cornfoot): Roadway &amp; Intersection Improvements</b>	<i>Widen and reconfigure intersections to better facilitate truck turning movements to the cargo area located within the airport area. Project includes sidewalks and bikeway improvements.</i>	\$4.1 M	Tier 1 - Partially Funded
<b>S8</b>	<b>82nd Ave/Alderwood Rd, NE: Intersection Improvements</b>	<i>Construct right turn lane on SB 82nd Ave; modify traffic signal and construct second right turn lane on Alderwood westbound. Project improves access to industrial properties.</i>	\$200 K	Tier 1 - Partially Funded
<b>S9</b>	<b>87th/Columbia, NE: Intersection Improvement</b>	<i>Widen intersection to accommodate large truck turning movements (53' trailer). Project includes r-o-w acquisition, retaining walls, bike lanes and sidewalks, and stormwater facilities. Project improves access to industrial properties.</i>	\$454 K	Tier 1
<b>S10</b>	<b>92nd Ave, NE, (Alderwood - Columbia BI): Street Improvements</b>	<i>Extend 92nd to Alderwood to improve better facilitate circulation in the Portland International Center development. Scope of project not fully defined.</i>	\$1.5 M	Tier 2
<b>S11</b>	<b>112th Ave/US 30, NW: Intersection Improvements</b>	<i>Add traffic signal to improve safety and property access.</i>	\$135 K	Tier 2
<b>S12</b>	<b>158th, NE (Columbia Slough - Sandy BI): Street Improvements</b>	<i>Reconstruct street to industrial standards, add sidewalks, stripe bike lanes, curb and storm drainage, and construct bridge to replace culverts at main slough crossing.</i>	\$480 K	Tier 3

<b>S13</b>	<b>Airport Way, NE (82nd - PDX Terminal): Street Widening</b>	<i>Widen to three lanes in both directions to improve traffic flow.</i>	\$10 M	Tier 2
<b>S14</b>	<b>Airport Way, NE: Access Road</b>	<i>Construct Airport Way East Terminal access road to improve access to properties.</i>	\$8 M	Tier 2
<b>S15</b>	<b>Alderwood/Columbia Blvd/Cully, NE: Intersection Improvements</b>	<i>Reconstruct intersection to provide left turn pockets, enhancing turning radii and improving circulation for trucks serving expanding air cargo facilities south of Portland.</i>	\$350 K	Tier 1
<b>S16</b>	<b>Alderwood/Cornfoot Road, NE: Intersection Improvement</b>	<i>Add signal and improve turn lanes at Alderwood Road/Cornfoot Road to improve safety, circulation, and access to PDX and Portland International Center properties.</i>	\$350 K	Tier 1
<b>S17</b>	<b>Argyle, NE (14th - MLK): Street Extension</b>	<i>Extend NE Argyle to provide better street grid. Will serve as a collector/distributor for industrial businesses &amp; reduce traffic congestion at MLK/Columbia intersection.</i>	\$480 K	Tier 3
<b>S18</b>	<b>Belmont Ramp, SE (Eastside of Morrison Bridge): Ramp Reconstruction</b>	<i>Reconstruct ramp to provide better access to the Central Eastside.</i>	\$1.5 M	Tier 2
<b>S19</b>	<b>Columbia Blvd, NE (60th - 82nd): Road Widening</b>	<i>Widen Columbia Blvd to five lanes in this segment to address a system bottleneck and improve property access.</i>	\$15 M	Tier 2
<b>S20</b>	<b>Columbia Blvd/MLK Jr &amp; Lombard/MLK Jr, NE: Intersection Improvements</b>	<i>Widen turn lanes at MLK Jr. intersections with Columbia and Lombard to facilitate truck turning movements.</i>	\$700 K	Tier 1
<b>S21</b>	<b>Columbia Blvd/Portland Rd, N: Intersection Improvements</b>	<i>Redesign of intersection could include realignment of travel lanes, channelization, signalization, signage, and new sidewalks and curbs. Project reinforces through-truck movements on truck streets and minimizes neighborhood cut-through traffic.</i>	\$700 K	Tier 1



<b>S22</b>	<b>Cornfoot, NE (47th-Alderwood): Road Widening &amp; Intersection Improvements</b>	<i>Road widening project including lighting and landscaping, left turn lanes, and bike lanes (47th - Airtrans Way). Signalize Cornfoot/Airtrans intersection and reconfigure traffic flow. Stripe bike lanes (Airtrans - Alderwood). Project improves traffic flow to air cargo facilities in airport area.</i>	\$2 M	Tier 1 - Partially Funded
<b>S23</b>	<b>East End Connector, NE</b>	<i>Construct an at-grade intersection connection from Columbia Blvd at 82nd to US 30 Bypass/I-205 interchange and widen I-205 southbound on-ramp at Columbia Bl. Project resolves an existing safety and capacity problem at terminus of Columbia Blvd at 92nd. Adds capacity to Lombard. With completion of project, Killingsworth replaces Columbia Blvd as NHS intermodal connector east of new connection.</i>	\$26.5 M	Tier 1 - Funded - Construction begins 2006
<b>S24</b>	<b>Going/Greeley, N: Climbing Lane and Interchange Improvements</b>	<i>Redesign Going/Greeley interchange including climbing lane on Going to improve truck movement between Swan Island, Lower Albina, and I-5.</i>	\$2 M	Tier 1
<b>S25</b>	<b>Grand Ave, SE: Bridgehead Improvements</b>	<i>Reconstruct west edge of SE Grand at bridgehead to provide sidewalks and urban standard turn lanes for vehicles. Improves truck safety and access.</i>	\$4.1 M	Tier 1
<b>S26</b>	<b>Heineman, N: Road Connection</b>	<i>Construct new street to provide access to developing Port of Portland industrial property.</i>	\$570 K	Tier 1
<b>S27</b>	<b>Leadbetter, N (Marine Dr Loop): Street Extension/Overcrossing</b>	<i>Extend Leadbetter to Terminal 6/Marine Drive, via a new rail overcrossing to provide access to developing Port property and address delay from at-grade rail crossing.</i>	\$10.8 M	Tier 1 - Partially Funded 1 - 5 Years
<b>S28</b>	<b>Lombard, N (Rivergate - T-6): Multi-modal Improvements</b>	<i>Widen N Lombard to include two travel lanes, a non-continuous center turn lane, medians, bike lanes, and sidewalks to improve safety and access to industrial properties.</i>	\$3.6 M	Tier 1 - Partially Funded 1 - 5 Years

<b>S29</b>	<b>Lombard/St. Louis/Ivanhoe Multimodal Improvements, N</b>	<i>Restripe, construct curb extensions, realign, and signalize as needed to improve pedestrian and bicyclist amenities while not impeding truck movements. Project maintains truck movement and minimizes conflicts with bicycles and pedestrians in town center.</i>	\$1.4 M	Tier 1 - Funded
<b>S30</b>	<b>Marx Dr, NE (82nd-87th): Street Extension</b>	<i>Extend NE Marx Dr west from 87th and signalize at 82nd Ave to provide better street connectivity for industrial properties.</i>	\$315 K	Tier 2
<b>S31</b>	<b>MLK Jr, NE (Columbia - Lombard): Widen Street</b>	<i>Expand roadway to provide better connection between streets for improved freight movement in and through the area.</i>	\$12.6 M	Tier 2
<b>S32</b>	<b>Morrison Bridge at Water Ave Ramp, SE: Ramp Realignment</b>	<i>Realign and separate the Morrison Bridge off-ramp to Water Avenue from the I-5 off-ramp by moving it north approximately 100' from the Yamhill/Water intersection. Construct a sidewalk and bike lane along the south side of the realigned ramp.</i>	\$1.75 M	Tier 1 - Funded - Construction begins 2005
<b>S33</b>	<b>Mt St Helens Ave, NE (Cascades Parkway - Alderwood Rd): Street Extension</b>	<i>Construct two-lane road extension to provide traffic access for developing properties.</i>	\$1.5 M	Tier 1
<b>S34</b>	<b>Parkrose Connectivity Improvements, NE</b>	<i>Supplement access route for commercial properties in Parkrose by creating a loop road connection (102nd and 109th, NE, Killingsworth - Sandy; Killingsworth, NE, 109nd - 102nd) serving truck access functions, pedestrian, and bike connections.</i>	\$500 K	Tier 3
<b>S35</b>	<b>River Ave, N (Port Center Way - River Ave): Street Extension</b>	<i>Evaluate econdary access road from Swan Island connecting to the Lower Albina Overcrossing at River. Improvements include roadway, drainage, pedestrian path &amp; bike routes. Project improves street connectivity for industrial properties.</i>	\$165,697	Tier 2
<b>S36</b>	<b>Southern Triangle Circulation Improvements, SE</b>	<i>Improve local street network and regional access routes in the area between the Powell/12th, Willamette River, railroad mainline and Hawthorne Bridge. Improve freeway access route from CEID to I-5 SB via the Ross Island Bridge.</i>	\$2.5 M	Tier 3

<b>S37</b>	<b>Southwest Quad, NE (at 33rd): Access to PDX Properties</b>	<i>Provide street access from 33rd into the SW Quad property to provide access to developing Port properties.</i>	\$1.5M	Tier 2
<b>S38</b>	<b>St Helens Rd (US 30), NW, (in Willbridge area): Traffic Improvements</b>	<i>Install center turn lane to NW Front to improve safety and property access</i>	\$300 K	Tier 1
<b>S39</b>	<b>St. Helens Rd (US 30), NW (at Saltzman &amp; Balboa): Intersection Realignment</b>	<i>Realign intersections to correct two offset intersections.</i>	\$600 K	Tier 2
<b>S40</b>	<b>Stark St, SE (2nd - Grand): Safety &amp; Capacity Improvements</b>	<i>Improve safety and capacity at the Stark/Grand intersection by restriping street to add eastbound lane, revising Stark to one-way eastbound between King-Grand, or implement a Stark-Oak one-way couplet between 2nd and Grand.</i>	\$50 K	Tier 2
<b>S41</b>	<b>Terminal 4 Driveway Consolidation</b>	<i>Consolidate driveways at Terminal 4 and Schnitzer Steel to improve industrial property access.</i>	\$1 M	Tier 1 - Funded
<b>S42</b>	<b>US 30 at Lake Yard Hub Facility, NW: Access Improvements</b>	<i>Provide an access lane on US 30 for trucks entering and/or exiting the site, add a signal at the entrance, and if needed construct an on-site access road and realigning tracks to improve access to intermodal yard and improve corridor safety.</i>	\$2 M	Tier 1 - Funded
<b>S43</b>	<b>Water Ave, SE (Caruthers - Division PI): Street Extension Phase II</b>	<i>Provide new roadway connection with sidewalks, bike lanes, landscaping, access to Willamette Greenway to improve access and circulation for industrial district.</i>	\$250 K	Tier 3
<b>S44</b>	<b>Water Ave, SE (Stark - Clay): Reconstruction</b>	<i>Reconstruct street to meet industrial needs and provide pedestrian enhancements.</i>	\$900 K	Tier 2
<b>S45</b>	<b>Sandy Bl, NE (122nd - City Limits): Multimodal Improvements</b>	<i>Widen street to three or five lanes with sidewalks and bike lanes.</i>	\$5.75 M	Tier 3
<b>S46</b>	<b>Ivanhoe/Philadelphia, N: Intersection Improvements</b>	<i>Redesign intersection to improve traffic and pedestrian circulation.</i>	\$107 K	Tier 3
<b>S47</b>	<b>82<sup>nd</sup>/Columbia, NE: Intersection Improvements</b>	<i>Widen and reconfigure intersection to improve access to air cargo areas.</i>	\$2M	Tier 1

---

**SYSTEM MANAGEMENT**

---

<b>SM1</b>	<b>14th/16th, NW/SW &amp; 13th/14th, SW, Glisan - Clay: ITS, Clay to Glisan</b>	<i>Closed-circuit TV (CCTV) camera at Everett. Changeable message signs at Glisan, Everett, Burnside, Taylor, Jefferson and Clay intersections.</i>	\$175 K	Tier 3
<b>SM2</b>	<b>82nd, NE/SE: ITS</b>	<i>Implement ITS infrastructure to allow monitoring &amp; control of traffic flow including circuit TV cameras &amp; variable message signs to improve safety, reduce neighborhood intrusion, &amp; help buses.</i>	\$350 K	Tier 1 - Funded - Construction begins 2006
<b>SM3</b>	<b>122nd, NE/SE (Airport Way - Powell): ITS</b>	<i>CCTV at Powell, Division, Stark, I-84 eastbound ramp, Halsey, Sandy and Airport Way intersections. Changeable message signs at I-84 ramp, Sandy and Airport Way. Traffic monitoring stations at Powell, Division, I-84 and Airport Way.</i>	\$200 K	Tier 2
<b>SM4</b>	<b>Airport Way, NE (I-205 - 158th): ITS</b>	<i>CCTV at I-205 and 122nd intersections. Variable sign at I-205. Monitoring stations at 122nd and 158th.</i>	\$220 K	Tier 1
<b>SM5</b>	<b>Beaverton-Hillsdale Hwy, SW: ITS</b>	<i>CCTV at Terwilliger, Bertha and Shattuck intersections. Changeable signs at Bertha/Capitol Highway and 56th.</i>	\$90 K	Tier 3
<b>SM6</b>	<b>Columbia Blvd, N/NE(I-205 - Burgard): ITS</b>	<i>CCTV at I-205 ramps, NE 82nd, NE 47th, NE 33rd ramps, MLK, Jr., I-5 southbound ramps, N Portland Rd, and N Burgard Rd. Changeable message signs at NE 82nd, MLK, Jr., and I-5 southbound ramps, N Portland Rd. Monitoring at I-205, NE 33rd, MLK, Jr., and I-5 southbound ramps.</i>	\$310 K	Tier 1
<b>SM7</b>	<b>Foster Rd, SE: ITS</b>	<i>CCTV at 50th/Powell, 82nd, 92nd, I-205, 112th, 122nd and Jenne Rd intersections. Changeable signs at 50th/Powell, 92nd/Woodstock, 112th, 122nd, Jenne. Monitoring at 50th, 82nd, I-205.</i>	\$145 K	Tier 3
<b>SM8</b>	<b>Going, N (Interstate - Greeley): ITS</b>	<i>CCTV at Greeley/Interstate intersections. Variable message sign for eastbound traffic at Greeley. Changeable message sign for eastbound traffic at Interstate. Monitoring station at Greeley.</i>	\$255 K	Tier 1

<b>SM9 Lombard, N/NE (Philadelphia MLK, Jr): ITS</b>	<i>CCTV cameras at intersections with MLK Jr, Interstate, Greeley, Portsmouth, Philadelphia/Ivanhoe. Changeable message signs at Interstate, Portsmouth and Lombard.</i>	\$210 K	Tier 3
<b>SM10 Macadam, SW (Bancroft - Sellwood Br): ITS</b>	<i>CCTV at Hood/Bancroft, Taylors Ferry and Sellwood Bridge. Variable sign at Hood/Bancroft. Changeable sign at Taylors Ferry. Monitoring at Bancroft and Sellwood Bridge.</i>	\$290 K	Tier 2
<b>SM11 Marine Dr, N/NE (Portland Rd to 185th): ITS</b>	<i>CCTV at N Portland Rd. Changeable message signs at Portland Rd, Vancouver and 185th.</i>	\$750 K	Tier 2
<b>SM12 McLoughlin, SE: ITS</b>	<i>CCTV at Holgate, 17th, Bybee, Johnson Creek/Tacoma. Variable sign at Holgate. Monitoring at Holgate and Bybee.</i>	\$250 K	Tier 1
<b>SM13 MLK Jr, N (Columbia Bl - CEID): ITS</b>	<i>CCTV at Hawthorne ramp, Clay, Belmont, Morrison, Burnside, Lloyd, Broadway, Fremont, Killingsworth, Lombard, Columbia, I-5/and Marine Dr. Changeable message signs at Madison, Morrison, Burnside, Lombard, I-5/Marine Dr. traffic monitoring stations at Clay, Burnside.</i>	\$550 K	Tier 2
<b>SM14 Rivergate ITS, N</b>	<i>Connect real-time information about the Rivergate road system to ODOT's Highway ITC systems.</i>	\$200 K	Tier 1
<b>SM15 Sandy Bl, NE (82nd - Burnside): ITS</b>	<i>CCTV at 12th, 37th, 39th, 57th, 72nd, 82nd, I-205 northbound ramp, and 122nd intersections. Variable signs at 37th, 102nd intersections. Changeable signs at 12th, 82nd, and 102nd. Monitoring stations at 12th, 57th, 82nd, I-205, 122nd and 162<sup>nd</sup>.</i>	\$340 K	Tier 3
<b>SM16 Yeon/St. Helens, NW: ITS</b>	<i>CCTV at Nicolai, Kittridge, St. John's Bridge, I-405/Vaughn/23rd intersection. Changeable signs at Nicolai/I-405, Kittridge and I-405/Vaughn/23rd. Monitoring at Nicolai and Kittridge.</i>	\$193 K	Tier 1
<b>SM17 Powell Blvd, SE (Milwaukie – 122<sup>nd</sup>): ITS</b>	<i>CCTV at 39<sup>th</sup>, 50<sup>th</sup>, 82<sup>nd</sup>, I-205 Ramp, 122<sup>nd</sup>. Variable signs at Milwaukie. Changeable signs at 39<sup>th</sup>, 50<sup>th</sup>, 82<sup>nd</sup>, I-205 ramps.</i>	\$395 K	Tier 2

## BRIDGE

B1	<b>21st, NE (at Columbia Slough): Bridge Replacement</b>	<i>Replace weight restricted bridge.</i>	\$5 M	Tier 2
B2	<b>33rd Ramps, NE, (at Columbia Bl/Lombard): New Ramps</b>	<i>New ramp system connecting Columbia and Lombard at 33rd Ave to facilitate truck movement.</i>	\$12 M	Tier 3
B3	<b>33rd, NE (at Columbia Slough): Bridge Replacement</b>	<i>Replacement of side-by-side bridges carrying NE 33rd Drive over Columbia Slough.</i>	\$3 M	Tier 1 - Funded - Construction starts 2006
B4	<b>33rd, NE (at Lombard): Bridge Replacement</b>	<i>Lengthen and replace main span carrying NE 33rd Ave over Lombard St. Project will improve bridge clearance and load rating.</i>	\$3.5 M	Tier 1 - Funded - Construction starts 2005
B5	<b>42nd Bridge, NE (at Lombard): Bridge Replacement</b>	<i>Replace 42nd bridge over Lombard to remove weight restriction and improve vertical clearance under bridge.</i>	\$3 M	Tier 3
B6	<b>82nd/Airport Way, NE: Overcrossing</b>	<i>Construct grade-separated overcrossing to improve efficiency of traffic flow to PDX properties.</i>	\$11 M	Tier 3
B7	<b>Denver Viaduct, N: Reconstruct Viaduct</b>	<i>Rebuild viaduct and add pedestrian walkway/bikeway. Project improves truck access to I-5.</i>	\$2 M	Tier 1 - Identified as Phase 2 alternative in I-5 Delta Park to Lombard project
B8	<b>Foster Rd, Bridge at Johnson Creek: Bridge Replacement</b>	<i>Replace southern bridge span. Bridge is currently weight restricted.</i>	\$1.4 M	Tier 1 - Funded - Construction begins 2007
B9	<b>Going St Bridge, N: Bridge Rehabilitation</b>	<i>Replace bridge over UPRR. Bridge is currently weight restricted.</i>	\$3 M	Tier 1 - Partially- funded - OTIA
B10	<b>Grand/ MLK Jr Viaduct, SE: Reconstruct Viaduct</b>	<i>Reconstruct viaduct between Stephens &amp; McLoughlin Blvd. Existing structure is deficient and requires capacity and structural design improvements.</i>	\$22 M	Tier 1 - Funded - Construction begins 2005
B11	<b>I-5, N (Columbia River - Columbia Bl): Bridge Widening</b>	<i>Improve I-5/Columbia River bridge (local share of joint project) based on recommendations in I-5 Trade Corridor Study. Project addresses a high congestion location.</i>	\$200 M	Tier 1 - Funded - Alternative analysis underway as part of Columbia River Crossing project

<b>B12</b>	<b>Interstate, N, Bridge at Larrabee: Bridge Rehabilitation</b>	<i>Rehabilitate Interstate overcrossing of Larrabee to remove weight restriction.</i>	\$1.2 M	Tier 3
<b>B13</b>	<b>Lombard at Columbia Slough Overcrossing (Rivergate), N: Bridge Rehabilitation</b>	<i>Strengthen Columbia Slough bridge and add sidewalks and bike lanes.</i>	\$4.9 M	Tier 1 - Funded - Construction begins 2010 (est.)
<b>B14</b>	<b>Lombard St. (Burgard), N: Bridge Replacement</b>	<i>Upgrade structure at entrance to Terminal 4 and Schnitzer Steel to eliminate load reconstructions on the bridge.</i>	\$1.5 M	Tier 1 - Funded - Construction begins 2005
<b>B15</b>	<b>Sellwood Bridge, SE/SW: Bridge Replacement</b>	<i>Replace weight restricted bridge.</i>	\$75 M	Tier 1
<b>B16</b>	<b>Vancouver BNSF Rail Bridge Project (Columbia River)</b>	<i>Replace existing swing span with lift span and relocate position to mid-river channel. Project creates wider and quicker opening, reduces I-5 Fwy lifts, eases river navigation, and could accommodate a third rail track.</i>	\$42 M	Tier 1
<b>B17</b>	<b>West Hayden Crossing, N: New Bridge</b>	<i>New four-lane bridge from Marine Drive to Hayden Island to serve as the primary access to marine terminals on the island.</i>	\$49 M	Tier 3
<b>B18</b>	<b>Willamette River Bridges, NE/NW/SE/SW: Rehabilitation</b>	<i>Provide for long-term rehabilitation and structural needs of the Broadway, Burnside, Morrison, and Sauvie Island bridges.</i>	\$113 M	Tier 1 - Funded - On-going
<b>B19</b>	<b>Vancouver Bridge, N (at Columbia Slough): Bridge Replacement</b>	<i>Replace deteriorating bridge to improve safety and remove weight restriction.</i>	\$8.5 M	Tier 1
<b>RAIL</b>				
<b>R1</b>	<b>Barnes Rail Yard - Bonneville Rail Yard, N: Track Expansion</b>	<i>Construct additional unit train trackage between Bonneville and Barnes Yards to support unit train movement between South Rivergate and the Columbia Corridor. Addresses limited Rivergate staging area for unit trains approaching the marine terminals. Solves switching bottlenecks, terminal access limitations, and other operational conflicts.</i>	\$11.9 M	Tier 2
<b>R2</b>	<b>BNSF Line @ Columbia Bridge, N: Track Improvements</b>	<i>Improve rail track conditions on approaches to movable spans over the Columbia River to increase track speeds in this section of the north/south main line.</i>	\$8 M	Tier 2

<b>R3</b>	<b>Kenton Rail Line, NE: Additional RR Tracks</b>	<i>Upgrade single track sections to double tracks built to mainline standards with new sidings from Peninsula Junction to I-205. Provides additional rail tracks for staging of Pacific Northwest unit trains. Expands capacity and reduces delays</i>	\$25.4 M	Tier 1
<b>R4</b>	<b>Marine Dr, N (at Rivergate West): Rail Crossing, Phase II</b>	<i>Reroute rail tracks and construct an above-grade rail crossing at Rivergate West entrance to improve safety and reduce vehicle and rail traffic conflicts.</i>	\$18 M	Tier 3
<b>R5</b>	<b>North Portland Junction, N: Rail Improvements</b>	<i>Upgrade rail track with revised crossovers, centralized traffic control tie-in and increased turning radius to accommodate higher rail speeds and capacity.</i>	\$5 M	Tier 2
<b>R6</b>	<b>Penn Junction, N, UP/BNSF Main Line: Track Realignment</b>	<i>Realign track configuration, double track, and upgrade signaling to improve mainline capacity over the Columbia River bridge and allow greater train turnaround speed.</i>	\$3.5 M	Tier 2
<b>R7</b>	<b>Ramsey Rail Complex, N (south of Columbia Slough Bridge): Capacity Improvements</b>	<i>Construct six tracks and one mainline track and lead into complex. Adds 46,000 linear feet of rail storage separate from the main line tracks. Improves regional heavy rail system efficiency. Solves storage capacity issues, bottlenecks, terminal access limitations, and other multimodal inefficiencies.</i>	\$13.2 M	Tier 1 – Partially funded
<b>R8</b>	<b>Rivergate Rail Yard Expansion, N</b>	<i>Expand railroad capacity in the Rivergate industrial area to increase bulk capacity for mineral and agricultural products and improve train flows within the industrial area.</i>	\$6 M	Tier 1
<b>R9</b>	<b>Slough Rail Bridge, N</b>	<i>Potential for future rail bridge across Columbia Slough to provide rail connection to south Rivergate from Terminal 6.</i>	\$4.5 M	Tier 3
<b>R10</b>	<b>T-5 Unit Rail Loops #3 &amp; #4</b>	<i>Construct two additional loop tracks to increase rail storage and rail handling capability of existing bulk terminal.</i>	\$2.8 M	Tier 1 – Partially Funded



<b>R11</b>	<b>T-6 Intermodal Third Lead</b>	<i>Construct a dedicated lead for the T-6 intermodal yard. Removes bottleneck at T-6 for unit trains, auto carriers, box cars, and tank cars.</i>	\$4.5 M	Tier 1 – Partially funded, construction expected in 2006
<b>R12</b>	<b>Terminal 6 A&amp;B Yards</b>	<i>Connect A and B rail yards to increase Terminal 6 rail capacity.</i>	\$3 M	Tier 2
<b>R13</b>	<b>UP Line Connection, SE (Brooklyn line - Graham line)</b>	<i>Add rail connection between the Brooklyn and Graham lines in Southeast Portland to increase rail capacity.</i>	\$11 M	Tier 1
<b>R14</b>	<b>UP Line Upgrade, SE (Albina Yard - East Portland)</b>	<i>Upgrade existing track to second main track to increase track speeds in this section of the north/south main line.</i>	\$8.8 M	Tier 1
<b>R15</b>	<b>West Hayden Island Rail Yard Expansion, West Hayden Island</b>	<i>Construct 7 track rail yard connected to facility trackage to advance rail-dependent development.</i>	\$9.5 M	Tier 3
<b>R16</b>	<b>West Hayden Island/Rivergate, N: Rail Access</b>	<i>Rail access from Rivergate to Hayden Island development to support development.</i>	\$3 M	Tier 1
<b>R17</b>	<b>Barnes to Terminal 4, N: Track Expansion</b>	<i>Provide a dedicated track for Terminal 4 through Barnes Yard and add a new track from Barnes Yard to Terminal 4.</i>	\$1 M	Tier 1

## **MARINE TERMINAL**

<b>M1</b>	<b>Access Tunnel at Hyundai/Kia Facility, N</b>	<i>Access tunnel to Rivergate from Terminal 6 to allow auto facility access to facility expansion in Rivergate.</i>	\$3 M	Tier 1
<b>M2</b>	<b>Columbia River Channel Deepening - Regional Share, N/NE</b>	<i>Deepen the Columbia River channel to 43 feet from Astoria and Portland to better serve the new class of larger container ships.</i>	\$150.5 M	Tier 1 - Phase 1 Funded
<b>M3</b>	<b>Container Crane - Terminal 6</b>	<i>Purchase post-panamax container crane to permit the efficient handling of larger container ships. Includes electrical upgrades to dock and addition of related yard equipment.</i>	12.5 M	Tier 1 - Funded - Delivery in 2006

<b>M5</b>	<b>Hyundai Auto Terminal Expansion, N</b>	<i>40 acre expansion of import auto terminal to allow capacity improvements to include paving, lighting, and storm water management.</i>	\$8 M	Tier 1
<b>M6</b>	<b>Mar Com North Facility, N</b>	<i>Acquisition, design, permitting, and development of 6.54 acre brownfield site adjacent to south side of Terminal 4 to provide additional auto storage capacity.</i>	\$2. M	Tier 1
<b>M7</b>	<b>Optional Terminal Lower Lot Access, N</b>	<i>Regrade hill slope to provide two-lane truck access to provide alternative access to lower lot.</i>	\$3 M	Tier 1
<b>M8</b>	<b>Terminal 4 Grain Elevator Barge Conveyor Rebuild, N</b>	<i>Rebuild conveyor connecting T4 grain elevator to Berth 405 barge unloader. Current conveyor will be removed with warehouse 1 and 2 demolition project. Barge facility use to transport Oregon wheat.</i>	\$1.5 M	Tier 1
<b>M9</b>	<b>Terminal 4 On-site Overcrossing, N</b>	<i>Construct overcrossing for trucks to improve access between lower T-4 and Lombard.</i>	\$2.5 M	Tier 1
<b>M10</b>	<b>Terminal 4 Pier 2 Rail Yard Improvements, N</b>	<i>Construct new yard with capacity of 200 loaded rail cars and 60 empty cars, replacing current capacity. Project will provide stormwater management for rail yard and upgrade riparian edge along Willamette R.</i>	\$54 M	Tier 1 - Funded - Completion by 2005
<b>M11</b>	<b>Terminal 4, N: Access Improvements</b>	<i>Provide terminal overpass - two lane hwy bridge and driveway improvement. Provide bulk terminal access via single lane tunnel under rail tracks. Project maintains domestic trucking access inside the rail loop and accommodates emergency vehicle access inside the bulk rail loop.</i>	\$10 M	Tier 2
<b>M12</b>	<b>Terminal 6 Additional Post-Panamax Cranes, N</b>	<i>Acquisition of three add'l post-panamax cranes to make T6 a two berth post panamax facility.</i>	\$33.4 M	Tier 3
<b>M13</b>	<b>Terminal 6 Berth Deepening</b>	<i>Provide design, permitting, and construction to deepen T6 container berths in conjunction with Channel Deepening project.</i>	\$1.25 M	Tier 1 - Funded - Completion by 2007
<b>M14</b>	<b>Terminal 6 Computer System Upgrades, N</b>	<i>Increase efficiency at the T6 container terminal with improved cargo tracking systems.</i>	\$2 M	Tier 1 - Funded - Completion by 2006

## FEDERAL, STATE, REGIONAL AND LOCAL TRANSPORTATION FINANCING IN PORTLAND AND OREGON

### HISTORY BRIEF OF TRANSPORTATION FUNDING NATIONALLY

Historically, financing of public roadways has come directly from the users of the transportation system – through taxation of gas and gasoline derivative products. The retail fuel companies on behalf of the State and Federal government collect the taxes. Each state determines its own taxing level. The federal tax is fixed nationwide. Traditionally, State taxes are to be used for construction and maintenance of State-designated highways that serve as connections between the Interstate system (now known primarily as the National Highway System) and the web of highways linking cities and towns around the State.

There are three distinct eras of transportation infrastructure building in recent history: Pre-WWII “Up and Out of the Mud”; “Post-WWII Interstate Highway Building” and “Flexible Multimode Financing”.

With the advent of production automobile manufacturing in the early 1900’s, dirt trails and roads crisscrossing the landscape provided nothing but a quagmire for the new conveyances. As a matter of necessity cars had to get “Up and Out of the Mud” to be able to perform their intended duties. Plank roads like the original Canyon Road (now Sunset Highway) provided some traction but the trip still remained slow. Not until the advent of Macadam pavement did the roadway network really begin to be a reliable way to get products from farm to market, connecting burgeoning cities and people to places of beauty.

The early road building era made State highway engineers in Oregon into early visionaries who could see that roadways were an economic necessity to bring goods to market and to attract people to populate the State. They were also the early financiers of the modern roadway. For example, the Columbia Gorge highway was envisioned as both a critical accessway through the Cascade Mountains as well as a unique architectural and engineering opportunity to allow residents to enjoy the natural scenic beauty of the Columbia Gorge. This early highway was constructed on the premise that it benefited private enterprise and the general public. Hence a partnership between the public and private sector was struck to finance the vision. The tradition continues today.

Of note, however, is that during this era cities were still based on streetcars, walking and compact form. All that was about to change.

#### **The Post-World War II Interstate Highway Building**

The post-WWII era in the early 1950’s set out to accomplish several goals: build an interconnected system of free public roadways of high quality and standards for national defense, and fast and reliable transport of goods to far reaching markets, further urbanizing cities and unifying the nation. In order to pay for such a system, the Highway Trust Fund was established by Congress and the precursor to today’s United States Department of Transportation (USDOT), the Department of Public Roads, was created. The Highway Trust fund was, and is, fed by the federal tax on gasoline. Funds were granted to the individual State highway departments to design and construct the Interstate Freeway System based on a formula and through congressional appropriations. States also taxed fuel purchases based on their needs to provide for their own state highway system and to match the federal dollars for the Interstate system.

Cities sprawled outward, enabled by personal travel freedom afforded by the auto. Buses (private) replaced streetcars. Walking was too difficult as the distances between activities grew longer.

The Interstate Highway construction era, which started in the early 50's, reached its peak in the mid-1960's. By the end of the decade not only was the majority of the system constructed, but the public's attitude about its impact on communities was changing. The advent of environmental consciousness, displacement of people and businesses, and social disruption of communities all led to reshaping the direction of public policy, finance and engineering standards for the national roadway networks.

The 1969 National Environmental Policy Act changed the way in which all federal, state and local agencies assure that any expenditure of federal dollars for most manmade public facilities of any type are not a detriment to the environment in which they are constructed. In the early 1970's, the pendulum moved away from freeway building to multimodal highway and transportation system construction. Limitations on the legislative mandate of federal, state and local funding programs did not allow gas tax dollars to be spent for non-highway purposes, such as transit, pedestrian and bicycle facilities. The Highway Trust fund could not be "busted" for these purposes. Legislation in the late 1970's followed the crisis of inner cities to maintain diesel bus services. Since World War II, City buses had been private in many locations. With the advent of suburban development many went bankrupt, leaving a void in the transportation system. Congress created the Urban Mass Transit Administration to step in to provide traditional fixed-route bus services and assistance for aging heavy rail systems. Financing from the federal government to operate, maintain and grow these systems was established. A chink in the Highway Trust Fund armor was created. Multimodal financing was on the horizon.

The Congressional passage of Intermodal Surface Transportation Efficiency Act or ISTEA in 1991 began the modern "Flexible MultiMode Finance" era. As has been tradition, transportation financing legislation has a six-year life. ISTEA and its successor TEA-21, the Transportation Equity Act for the 21st century, provide for the Highway Trust Fund to be used for all modes of surface transportation. Each Congressional bill has specific provisions for different modal categories of money that can be expended by states, counties and cities based on prescribed formulas. Transportation system financing has been expanded to integrate modes, encourage the public's use of alternatives to single-occupant vehicles and to diminish environmental impact.

Congress is currently negotiating the third generation of flexible funding transportation bills or TEA-LU, the Transportation Equity Act a Legacy for Users. This pending TEA-LU bill should have been enacted in September 2003 to enable the six-year extent of its authority. Due to disputes between the Administration, House and Senate over funding dollar amounts and provision of the new bill, the date of enactment remains unclear. Extensions of the previous TEA- 21 Bill are evoked monthly and quarterly to allow transportation agencies to proceed with projects.

## **FEDERAL TRANSPORTATION FUNDING PROGRAMS**

Of the myriad highway and multimode funding programs in the existing Six Year TEA-21 Bill, this overview discusses only those that are relevant to the City of Portland, Office of Transportation, Metro, and in part to the Oregon Department of Transportation and TriMet. Since federal transit dollars are largely allocated to TriMet they are not discussed in detail here.

The following major highway program funds are available as part of the TEA -21 Bill.

- National Highway System (NHS)
- Surface Transportation Program (STP)
- Congestion Management Air Quality (CMAQ)
- Transportation Enhancement (TE)
- High Priority (Demonstration) Projects (HPP)
- Highway Bridge Replacement and Rehabilitation Program (HBRRP)
- Intelligent Transportation Systems Program (ITS)

Within each of the program categories are specific sub-categories that may be relevant to the City and region.

## **NATIONAL HIGHWAY SYSTEM (NHS)**

Program purpose: funding for improvements to rural and urban roads that are part of the NHS, including the Interstate System and designated connections to major intermodal terminals. In some instances NHS funds may be used for transit improvements in NHS corridors.

Distribution of funds based on the following formula:

- 25% based on total lane miles of principal arterials – excluding the Interstate System – in each state as a percent of total such principal arterial lane miles in all states.
- 35% based on total vehicle miles traveled (VMT) on lanes and principal arterials (excluding Interstate System) in each State as a percent of total VMT or lanes of such principal arterials in all states.
- 30% based on diesel fuel used on all highways in each state as a percent of diesel fuel used on all highways in all states
- 10% based on total lane miles of principal arterials in each state divided by total population in each state as a percent of such ratio for all states.
- Up to 50% of apportionments can be transferred to IM, STP, CMAQ and/or bridge programs or 100% may be transferred to STP on approval of the Secretary of Transportation.

Funds may also be used for intercity and intracity bus terminals, natural habitat mitigation and ITS improvements.

## **How NHS funds Are Used in the Portland Region**

Candidate projects are programmed through the ODOT STIP during a public process, which includes the local transportation agencies. The STIP is coordinated with the Metro MTIP process.

Typically, NHS funds are used for Interstate Freeway, primary state routes and freight-intermodal and bridge projects. As an example, NHS funds are being used to fund the I-5 Bridge influence area analysis and design work.

Match requirements are 10.27%.

## **SURFACE TRANSPORTATION PROGRAM (STP)**

Program purpose: To provide flexible funding that may be used by states and localities for projects on any Federal-aid highway (FAH), including the National Highway System (NHS), bridge projects on any public road, transit capital projects and intracity and intercity bus terminals and facilities.

Distribution of federal highway funds based on formula:

- 25% based on total lane miles of Federal-aid highway (FAH) in the State as a percent of total FAH lane miles in all states.
- 40% based on total vehicle miles (VMT) in lanes of FAH in the State as a percent of total VMT on lanes of FAH in all states.
- 35% based on estimated tax payments attributable to highway users in the State paid into the Highway Account of the Highway Trust Fund (HTF) in the latest fiscal year for which data are available, as a percent of total such payments by all states.

State sub-allocations of apportioned funds set-asides including:

- 10% set aside for safety improvement projects including railway/highway crossings.
- 10% set aside for transportation enhancements (TE) up to 25% of the difference between the amount set aside for TE for the fiscal year and the amount set aside for the TE for FY 97 may be transferred to IM, NHS, CMAQ or the Bridge Program.
- Set aside for urbanized areas over 200,000 population.
- States are required to make available obligation authority to urbanized areas over 200,000 population in two – three year movements over the life of the Bill.

### **How STP Funds Are Used in the Portland Region**

STP funds are “flexible federal funds” meaning they can be used to finance a variety of modal projects.

- ODOT programs STP funds through their statewide transportation improvements program (STIP) which is updated every two years and delivers funds over a four-year timeframe with minor realignments every year. A portion of ODOT’s STP funds are to provide elderly and disabled services as well as a small allocation to the public transit division.
- Metro distributes STP funds to all agencies in the Portland region as a part of the “Transportation Priorities MTIP” process undertaken every two years for funds programmed for a four-year timeframe. Although a four-year look is provided, funds are programmed for the last two of every four-year timeframe. For example, for the current 2006-09 MTIP process, Metro is programming new projects only for years 2008 and 2009. In the intervening years like 2005, only minor adjustments to existing programmed projects will be made.

The 2006-09 MTIP will be integrated into the ODOT STIP timeline so that from this year forward the ODOT STIP and MTIP process will be coincidental.

Typically STP funds in this region are used for highway-related improvements like main streets, freight, reconstruction and bridge project types. As an example STP funds are being used for the Rivergate Rail Overcrossing project. They are also financing NW 23rd Avenue reconstruction.

Match requirements are 10.27% from a local source.

### **CONGESTION MITIGATION AND AIR QUALITY IMPROVEMENTS PROGRAM FUNDS (CMAQ)**

Program purpose: Provides funding for projects and programs in air quality nonattainment and maintenance areas for ozone, carbon monoxide and small particulate matter that reduce transportation related emissions.

Distribution of funds according to the following formula:

- New weighting factors for ozone and CO maintenance areas.
- Up to 50% of the difference between the original program level of \$1.35 billion annually and the actual annual program level can be transferred to STP, NHS, IM and/or Bridge.
- States may allocate funds to private and non-private entities for land, facilities, vehicles and project development activities.

### **How CMAQ Funds Are Used in the Portland Region**

- Approximately \$11.5 million in CMAQ dollars are available to the Portland region on an annual basis. Note: Portland is now a CO attainment or maintenance area. CMAQ funding levels in the pending TEA-LU Bill may change.
- CMAQ is part of the METRO administered “flexible federal funds” allocated every two years through the “Transportation Priorities” MTIP process.

- Examples of projects funded by this program include bicycle, pedestrian and transit system (both rail and bus) improvement projects, main streets, transit-oriented developments.
- Match requirements are 10.27% from a local source.

### **TRANSPORTATION ENHANCEMENTS FUNDS (TE)**

Program purpose: Provides transportation-related activities that are designed to strengthen the cultural, aesthetic and environmental aspects of the nation's intermodal transportation system.

Provides for the implementation of a variety of non-traditional projects including restoration of historic transportation facilities, bike and pedestrian improvements, landscaping, beautification, mitigation of water pollution from highway run-off, and the establishment of transportation museums.

Ten percent allocation of STP funds go to TE funds.

### **How TE Funds Are Used in the Portland Region**

- Approximately \$4 million in TE funds are available statewide. The Portland region historically receives approximately \$1 – 1.5 million every two years for one, or possibly two projects.
- ODOT administers this program through a public solicitation process that is semi-coincidental with the Metro MTIP process. ODOT uses the Metro TPAC and JPACT advisory boards to screen candidate projects. ODOT assesses a select list of potential projects statewide and determines a final list based on specific program criteria.
- Examples of projects selected for funding through this program include parts of the Springwater Trail for bicycles and pedestrians and the preliminary design for reconstruction of the Union Station.
- Match for these projects is usually 10.27%. However, states may apply funds from other Federal agencies to the non-Federal share of the project. The local match can also be calculated on a project, multiple project or program basis. Therefore, it is possible that no local match may be required.

### **HIGH PRIORITY (DEMONSTRATION) PROJECTS**

Program purpose: This program provides funding for projects identified by Congress with a specific amount of funding over the six years of TEA-21. The designated funding can be used only for the specified project. This is commonly known as earmarked funds. Allocation of funds authorized for each project are to be made available for obligation over the six year period in roughly a 1/6 split in each year of the TEA 21 Authorization Bill.

It also establishes advance construction, which permits states to construct High Priority projects without the aid of Federal funds and then be reimbursed as the Federal funds become available in accordance with the distribution schedule.

### **How High Priority Funds Are Used in the Portland Region:**

Typically these requests come directly from transportation agencies and are coordinated generally both at the formulation states of a new Transportation Bill and annually through JPACT as annual Appropriation requests are made of the Oregon Congressional delegation.

Metro, through TPAC and JPACT, prepares a regional, adopted appropriations project list which is submitted as part of the Oregon Congressional delegation visit by JPACT members in March of each year.

During the formulation of both programmatic and project requests for a new Six-Year Transportation Bill, TPAC and JPACT will begin to formulate a position paper one year in advance of a new bill's authorization. The region currently has a JPACT-adopted position paper and project request list that has been presented to the Oregon Congressional delegation in March 2003 and 2004.

Annual appropriations requests are coordinated through the City of Portland's Intergovernmental Relations office. A

comprehensive list of annual appropriations citywide is submitted to City Council by Resolution to ensure coordination where federal finance opportunities could potentially be piggybacked.

### **INTELLIGENT TRANSPORTATION SYSTEMS PROGRAM (ITS)**

Program purpose: provides for research, development and operational testing of Intelligent Transportation Systems aimed at solving congestion and safety problems, improving operating efficiencies in transit and commercial vehicles, and reducing the environmental impact of growing travel demand.

Allocation of funds is the same as other federal aid programmed funds. ITS program elements fall into two categories: research and development and deployment incentives. The latter allowing for implementation of those concepts developed on the research and development side of the program.

#### **How the ITS Funds Are Used in the Portland Region**

- Examples of projects that use this funding source are the corridor-wide ITS projects on Powell Boulevard that provide improved signal timing for bus advantage at intersections.
- Match requirements for these programs and deployment are 10.27% local funds.

### **HIGHWAY BRIDGE REPLACEMENT AND REHABILITATION PROGRAM (HBRRP)**

Program purpose: provides funds to assist the states in their programs to replace or rehabilitate deficient highway bridges and to seismically retrofit bridges on any public road.

Allocation of funds:

- Bridge discretionary funds are \$100 million; \$25 million of that total must be spent on seismic retrofit.
- Funds are distributed according to each state's relative share of the total cost to repair or replace deficient highway bridges.
- Up to 50% of apportionments can be transferred to IM, NHS, STP and/or CMAW programs.
- Federal dollars guarantee a minimum of 25% of HBRRP funds to each state; no state shall receive more than 10% of the federal total.

#### **How HBRRR Funds Are Used in the Portland Region**

- Examples of projects that use this funding source include the Bybee Bridge project and the Martin Luther King, Jr Viaduct.
- Match requirements for this source of funds is 10.27% local funds.

### **STATE FUND TRANSPORTATION FINANCING**

#### **FEDERAL FUND "PASS THROUGH" TO STATES/LOCALS**

As described above, many federal USDOT funds are passed through the State via ODOT to the local jurisdictions.

Federal funding programs including NHS, ITS, HBRRP, and some STP allocations are "passed through" the State to locals. To request funds from any of these sources the request must be submitted and approved in the four-year STIP.

#### **HOW STATE GAS TAX IS APPORTIONED**

State collected gas taxes are apportioned to counties and cities based on unique formulas for each jurisdiction. The City receives a share of the 15.57% of motor fuels tax based on its population size relative to all other cities in the state, vehicle registration fees and weight mile tax on trucks. The annual dollar amount totals about \$21 million. In addition, through an agreement, Multnomah County and the City share in the pooled dollars available to the County. That sum totals about \$21 million annually.



Revenue sources administered by ODOT that are available to local jurisdictions through the ODOT Statewide Improvement Program process:

- Oregon Transportation Investment Act (OTIA) I through III.
- OTIA I and II authorized by the legislature in 2001 and 2002, provides for \$500 million in state bonding proceeds for modernization and preservation of Oregon's transportation system. Local matching funds statewide of \$146 million bring the total to \$646 million. Those funds are apportioned generally \$250 million for modernization; \$175 million for bridge and rehabilitation and \$75 million for preservation.
- OTIA I and II funds are competitive statewide and have stringent criteria by which prospective projects are judged. They are generally committed to "shovel-ready" projects. Local projects funded through OTIA I and II are the East End Connector and Sandy Boulevard projects.
- OTIA III, passed by the Legislature in 2003, provides for \$ 1.3 billion.
- in replacement and repair of state bridges; \$300 million in replacement of local bridges and \$300 million in modernization funds.
- ODOT has established program criteria appropriate to the category judged. Prospective projects are submitted by a statewide transportation agencies committee including municipalities, counties, and port authorities. The committee make a recommendation on a list of projects, based on technical and public review, to the Oregon Transportation Commission (OTC). The OTC is the final decision-maker.

#### **OREGON BICYCLE AND PEDESTRIAN PROGRAM**

Administered by ODOT – commonly known as the “Ronkin” fund. Michael Ronkin is the ODOT administrator for bicycle and pedestrian programs. One percent of statewide gas tax is allocated to these facilities.

This is a competitive program that is on the same two-year cycle as the Metro MTIP. It is slightly out of synch with the MTIP “Transportation Priorities” MTIP timetable. For example, for the year 2008-09, the State is requesting that all submissions for review are submitted in July 2004 for lengthy scrutiny over the summer and incorporation into the draft STIP in September 2004.

#### **TRANSPORTATION SAFETY PROGRAM**

Supports safety programs throughout the state at approximately \$5 million per year.

#### **RAILROAD CROSSING SAFETY IMPROVEMENT PROGRAM**

As the title implies this program funds improvements to unsafe crossings with signals, crossing hazard signage and placement of crossing arms. Approximately \$2 million per year available statewide.

#### **TRANSPORTATION DEMAND MANAGEMENT PROGRAM**

ODOT finances programmatic opportunities that provide transportation travel options to the private automobile and assist in achieving air quality in urban areas. An example, is the Portland Travelsmart program that educates communities about travel options available to them. \$2 million is available statewide annually.

#### **OREGON PLAN FOR SALMON AND WATERSHEDS**

A culvert restoration program exists for streams with historic fish runs and where barriers to fish movement can be mitigated. The annual amount available statewide is \$3 million.

#### **THE LOCAL FUNDING PROCESS**

##### **Metro Metropolitan Transportation Improvement Program (MTIP) “Transportation Priorities” Process**

Regional flexible federal funds that are administered by Metro, the regional federally recognized metropolitan planning

organization for the Portland region.

“Flexible” funds may be spent on a wide variety of transportation projects or programs. These funds constitute about four percent of the total annual spending on transportation in the Portland region.

Allocation of flexible funds occurs every two years as denoted in the TEA 21 Authorization Bill. As an example, funds are currently being programmed for 2008-09 specifically and adjustments made to projects programmed in 2006-07, hence the entire program years are defined as 2006-09.

Two sources of regional flexible funds are:

- Surface Transportation Program (STP) which may be used for any transportation improvement with the exception of local streets. The region receives approximately \$17.63M annually for allocation to local transportation agencies.
- Congestion Mitigation/Air Quality (CMAQ) funds may be used for projects, which demonstrate that some improvement in air quality will result from building or operating a program. CMAQ funds represent approximately \$11.25 million of the total \$28.88 million available annually in flexible federal funds.

How regional flexible funds are allocated as a part of the Transportation Priorities Process also known as the “Metropolitan Transportation Improvement Program or MTIP”:

Project applications are submitted to Metro on behalf of eligible public sponsors (like the City of Portland). These applications address specific questions regarding project cost, and ability to meet the objectives adopted by the Joint Policy Advisory Committee on Transportation (JPACT) and the Metro Council to guide the allocation of funds.

The primary objective for the Transportation Priorities 2006-09 program is to leverage economic development in priority 2040 Framework Plan land use areas through investments that support:

- 2040 Tier I and II mixed use areas (central city, regional and town centers, main streets and station communities).
- 2040 Tier I and II industrial areas (regionally significant industrial areas and other industrial areas).
- 2040 Tier I and II mixed-use and industrial areas within the urban growth boundary expansion areas with completed concept plans.

Other policy objectives include:

- Emphasis on modes that do not have other sources of revenue.
- Completion of gaps in the modal systems.
- Development of a multimodal transportation system with a strong emphasis on funding bicycle, boulevard, freight, green street demonstration, pedestrian, regional transportation options, transit-oriented development and transit projects and programs.
- Meet the average annual requirements of the State Implementation Plan for air quality for the provision of pedestrian and bicycle facilities.

### **Process for Selection of Projects**

1. An initial screening process is done by Metro staff using the selection criteria outlined above. Project applications are ranked considering those criteria and a draft list of projects 150% over the total dollar amount available to allocate is submitted for public review. The candidate list must comply with elements 2-9 below.
2. Candidate projects must be consistent with regional street design guidelines for its designated design classification.
3. Candidate projects must be in the Regional Transportation Plan (RTP) and in the local Transportation Systems Plan

and be consistent with the regional functional classifications described in the RTP.

4. Candidate projects must be included in the Financially Constrained system of the 2004 RTP or otherwise eligible for consideration as an amendment of the financially constrained system.
5. The total cost of submitted projects must be consistent with established cost targets for each jurisdiction. For Portland in 2008-09, \$33.1 million.
6. The applicant is in compliance with the Metro functional plan.
7. The applicant must make a statement that the project is deliverable within the funding timeframe and prepare a brief summary of the anticipated project development schedule.
8. Projects of less than \$200,000 are not encouraged because administrative costs of bringing a project to bid is relatively high.
9. Public involvement is conducted by Metro through public meetings held by JPACT. This committee, along with the Metro Council, recommends projects for further consideration and public comment, narrowing the candidate list of projects to 150% of available funding. JPACT and the Metro Council may direct staff to develop a technical recommendation on a final list of projects and programs for the Council and JPACT's consideration.
10. Metro staff and TPAC recommend a final selection of projects to JPACT and the Metro Council within available funding revenues.
11. Air quality model analysis is provided on the list of projects to meet air quality conformity regulations.
12. The Metro Council adopts the final package and funds are ready for disbursement.

### **The City of Portland—Office of Transportation's "Transportation Priorities" MTIP and State Funding Coordination Process**

The Office of Transportation (PDOT) coordinates the City's regional, state and federal solicitation of transportation funds for all city agencies and bureaus, as well as supports candidate projects for the Port of Portland and Multnomah County in the MTIP process.

PDOT has responsibility for coordinating the following discreet funding processes:

- Biennial Metro "Transportation Priorities MTIP" process for regional flexible funds.
- Biennial ODOT Statewide Transportation Improvement Program (STIP) in concert with the MTIP. ODOT requests that local transportation agencies submit requests for projects on the state's highway system that are funded by the STP, ITS, and HBRPR programs.
- Biennial Transportation Enhancements (TE) program.
- Biennial ODOT Pedestrian and Bicycle Project statewide allocation.
- Annual High Priority federal demonstration projects commonly known as Congressional Appropriations earmarks. Coordination occurs formally through resolution at TPAC and JPACT.
- Every six years, Congressional reauthorization of the Transportation Bill occurs. Coordination of project earmarks (High Priority) and programmatic changes through resolution at TPAC and JPACT.

### **Process Specific Timelines for Funding Process Coordination**

PDOT uses the process outlined below for all of its transportation funding coordination responsibilities with other agencies and bureaus. Transportation Planning staff acts as the inter and intra bureau list coordinators. Note that this process is currently under review by the PDOT Directors Team and is subject to some revision.

Most funding programs are on a two-year cycle. For those that are on annual cycles, projects are chosen from the larger two-year cycle project listings compiled for the "Transportation Priorities MTIP Process", JPACT federal project list or the Transportation Systems Plan Transportation System Improvements or Reference Lists.

Anomalous situations arise that have to be accommodated. If that situation occurs, the same general process principles, eg. the same committee structure and processing requirements are adhered to.

The following schedule applies to the “Transportation Priorities” MTIP Process and serves as the guide for all other funding source list production. Note that this process starts on even numbered years:

- January— two meetings
- PDOT Directors Team (bureau managers, director and division managers from finance and planning) provides project list development criteria and policy emphasis complementary to Metro section criteria as the basis for the PDOT Capital Oversight Committee (COC) review and refinement of prospective project lists. The Directors Team may advance different policy perspectives for selection of projects from year-to-year based on the type, scope, local match availability, need and location of the city’s transportation infrastructure at a given point in time.
- End of January through May— The COC (represented by bureau and division managers and modal coordinators) meets monthly to provide internal review of a prospective project list.
- End of January— Transportation Planning re-establishes an inter-agency committee of participating bureaus and other agency representatives of process schedule and selection criteria.
- February through May— The inter-agency committee meets monthly to review their individual list production and that of PDOT’s COC.
- June— The PDOT COC and inter-agency committees merge lists (in the MTIP process) to reach consensus on a draft list of project totaling 200 % of regional flexible dollars available for distribution.
- July—The draft list is finalized. Transportation Planning staff develops a Council Resolution for adoption detailing the policy rationale for the 200% list of projects.
- July through early November—Transportation Planning provides internal project managers and inter-agency managers with a comprehensive list of projects for which applications must be provided. All agencies and bureaus are responsible for providing their own applications, including cost estimates, unless prior arrangements are made with PDOT.
- Early November— One month prior to project application submission to Metro, PDOT COC and MTIP application managers set two meetings with agency staff to review project applications. The purpose for the meeting is to determine if project cost estimates are on target, and if projects require re-scoping or must be dropped to comply with target dollar allocation.
- Mid December— Two days prior to the project submission deadline, the Transportation Planning coordinator collects paper and electronic copies of all projects to be submitted to Metro. Transportation Planning staff bundles all projects from city bureaus, the Portland Development Commission, the Port of Portland and Multnomah County and hand delivers the package to Metro.
- Mid December through February— Metro provides technical rankings and a draft environmental justice analysis is released. Public hearings are held by Metro on the draft list.
- February-March— The 150% cut list recommendation is released by Metro.
- March-April— Public hearings are held by Metro on the 150% list. Final recommendations are approved.
- May-June— Air quality conformity determination is completed by Metro. A public hearing is held and STIP reporting and documentation is completed.
- July— Full MTIP adoption before TPAC and JPACT and Metro Council occurs in July.
- October— Obligation of federal fiscal year funding begins.
- End of process.

*Notes: No discussion is included in this document about federal financing for transit programs and projects primarily because Federal Transit Administration administered funds are the primary, but not the sole responsibility of TriMet both from a financing and operational viewpoint. Note that CMAQ and STP funds can be used for most transit capital projects. Federal “Section 5309” transit operating funds are used by TriMet for the stated purpose and not for highway related capital investments.*

**PREPARING THE PLAN – PUBLIC INVOLVEMENT**

Following is a description of the community involvement and outreach activities for the Freight Master Plan.

**Community Events**

- February 4, 2004            Community Open House            Montgomery Park, NW Portland  
Event introduced the freight planning process to the community and gather input on needs and deficiencies.
- January 27, 2005            Public Workshop                    Oregon Assoc. Minority Entrepreneurs, N Portland  
Event participants reviewed existing conditions information and provided input on freight-related issues.
- June 9, 2005                Community Open House            OMSI, SE Portland  
Event provided an opportunity to review and comment on draft elements of the Freight Master Plan.

**Community Presentations**

<b>Date</b>	<b>Audience</b>
2/4/2003	Columbia Corridor Association - Transportation Committee
4/1/2003	Central Eastside Industrial Council
9/10/2003	Portland City Council Hearing - Resolution and Interim Freight Master Plan
10/2/2003	Oregon Planning Institute Conference
10/4/2004	Cascadia Convergence Conference
11/3/2004	Transportation Association of Portland
2/8/2005	Portland Planning Commission Briefing
2/28/2005	Portland Citywide Land Use Group
3/4/2005	North Portland District Coalition
3/9/2005	NWDA and NW District Coalition
3/10/2005	Oregon Trucking Association - Highway Committee
3/14/2005	Arlington Heights Neighborhood Association
4/7/2005	Lloyd District Association
4/18/2005	SE Uplift - Transportation Committee
5/16/2005	NWDA Transportation Committee
5/18/2005	Pearl District NA – Transportation Committee
7/13/2005	Brooklyn NA Board Meeting
7/20/2005	Pearl District NA - Transportation Committee
7/20/2005	Brooklyn NA General Meeting
7/25/2005	Citywide Land Use Group
8/1/2005	SE Portland Rotary Club
9/12/2005	St. Johns Neighborhood Association
9/13/05	Friends of Cathedral Park
9/14/05	East Portland Land Use Committee
9/14/2005	Kenton Neighborhood Association
9/15/05	Arbor Lodge Neighborhood Association
9/26/05	University Park Neighborhood Association
10/4/05	Portsmouth Neighborhood Association

## Advisory Committee Presentations

<b>Date</b>	<b>Audience</b>
2/12/2003	Portland Bicycle Advisory Committee
2/20/2003	River Industrial Economic Advisory Group
2/21/2003	Oregon Freight Advisory Committee
2/26/03	Portland Freight Committee Kick-off
3/25/2003	Portland Freight Committee
5/15/2003	Portland Freight Committee
6/17/2003	Portland Pedestrian Advisory Committee
8/20/2003	Portland Freight Committee
9/25/2003	Portland Freight Committee
12/4/2003	Portland Freight Committee
1/8/2004	Portland Freight Committee
2/5/2004	Portland Freight Committee
2/25/2004	Oregon Freight Advisory Committee
3/4/2004	Portland Freight Committee
4/1/2004	Portland Freight Committee
5/6/2004	Portland Freight Committee
5/18/2004	Portland Pedestrian Advisory Committee
6/3/2004	Portland Freight Committee
7/8/2004	Portland Freight Committee
8/5/2004	Portland Freight Committee
9/1/2004	Freight Technical Advisory Committee
9/2/2004	Portland Freight Committee
9/24/2004	Freight Technical Advisory Committee
10/7/2004	Portland Freight Committee
10/12/2004	Portland Bicycle Advisory Committee
10/26/2004	Freight Technical Advisory Committee
11/4/2004	Portland Freight Committee
12/2/2004	Portland Freight Committee
12/21/2004	Freight Technical Advisory Committee
1/6/2005	Portland Freight Committee
2/1/2005	Freight Technical Advisory Committee
2/3/2005	Portland Freight Committee
2/23/2005	Freight Technical Advisory Committee
3/3/2005	Portland Freight Committee
3/31/2005	Freight Technical Advisory Committee
4/7/2005	Portland Freight Committee
4/14/2005	PDOT Leadership Team
5/5/2005	Portland Freight Committee
5/20/2005	Multimodal Street Design Workshop
5/24/2005	Freight Technical Advisory Committee
6/2/2005	Portland Freight Committee
6/2/2005	Bureau of Planning District Liaisons
6/21/2005	Freight Technical Advisory Committee
6/21/2005	Portland Pedestrian Advisory Committee
7/12/2005	Bicycle Advisory Committee

## REFERENCES

Following is the list of references used to develop the Freight Master Plan.

### Mobility

Break don't Bend your Supply Chain, by Perry Trunick, Logistics Today: The Publication for Logistics Leaders, November 21, 2004.

Columbia Corridor Transportation Study, City of Portland Office of Transportation, adopted by the Portland City Council in 1999.

Express - Oregon Trucking Associations Newsletter, ortruck@ortrucking.com

Freight Planning Support System, Final Summary Report, prepared for the North Jersey Transportation Planning Authority by the National Center for Transportation and Industrial Productivity at the New Jersey Institute of Technology, Newark, NJ, July 2003

I-5 Rail Capacity Study, I-5 Transportation and Trade Partnership, Oregon Department of Transportation, February 2003.

Identifying High Priority Freight Mobility Projects: Summary of the Oregon Freight Advisory Committee Approach, Oregon Freight Advisory Committee, 2/2004, [http://www.oregon.gov/ODOT/TD/FREIGHT/docs/FAC\\_Recommendations\\_High\\_Priority\\_Freight\\_Mobility\\_Projects.pdf](http://www.oregon.gov/ODOT/TD/FREIGHT/docs/FAC_Recommendations_High_Priority_Freight_Mobility_Projects.pdf)

Implementing a Statewide Goods Movement Strategy and Performance Measurement of Good Movement in California, Daniel Barber and Lisa Grobar, California State University, Long Beach, June 2001

Key Freight Transportation Challenges: Congestion and Capacity, Federal Highway Administration, Office of Freight Management and Operations, Washington, DC, January 2005.

Managed Lanes, Jon Obenberger, Public Roads, November/December 2004.

Maritime Transportation Service Report to Congress: Trends and Competitive Pressures, USDOT Maritime Transportation Service, Washington, DC, 2004, page III-2.

Measuring Improvements in the Movement of Highway and Intermodal Freight, Federal Highway Administration, March 2000, Contract No. DTFH61-97-C-00010, BAT 99-021

Public Roads, Operational Solutions to Traffic Congestion, FHWA, November/December 2004

Quick Response Freight Manual, Federal Highway Administration, Washington, DC, September 1996. <http://tmip.fhwa.dot.gov/clearinghouse/docs/quick/appf.stm>

Regional Transportation Plan, Metro, 2004, <http://www.metro-region.org/article.cfm?ArticleID=137>

Reliability: Critical to Freight Transportation, Scott Johnson and Joanne Sedor, Public Roads, November/December 2004.

St. Johns Truck Strategy, City of Portland Office of Transportation, adopted by the Portland City Council in 1999.

Statewide Congestion Overview for Oregon, Oregon Department of Transportation, Transportation Planning Analysis Unit, Salem, OR, February 2004.

Summary of the Vancouver BNSF Rail Bridge Project: A Presentation to JPACT (Joint Policy Advisory Committee on Transportation for the Portland/Vancouver region), by the Ad-Hoc Steering Committee for the Vancouver Rail Bridge Upgrade Project, January 15, 2004.

Truckline, A Publication of the American Trucking Associations, <http://www.truckline.com/legislative/regulatory/PRESS%20RELEASE-HOS%20Rules%20Vacated.doc>.

Trucks and Transportation, Michigan Department of Transportation, February 1998

## **Economics**

---

Benefit-Costs Analysis of Highway Improvements in Relation to Freight Transportation: Microeconomic Framework, Federal Highway Administration, Washington, DC February 2001

Citywide Industrial Land Inventory and Assessment, Portland Development Commission, July 2003, [http://www.pdc.us/pubs/inv\\_detail.asp?id=100&ty=23](http://www.pdc.us/pubs/inv_detail.asp?id=100&ty=23)

Commodity Flow Forecast Update and Lower Columbia River Cargo Forecast, prepared for the Port of Portland, METRO, Oregon Department of Transportation, Port of Vancouver and Regional Transportation Council, by DRI-WEFA, BST Associates and Cambridge Systematics, Inc., Cambridge, MA June 2002

Economic & Bridge Options Report, Oregon Department of Transportation – Transportation Planning Analysis Unit, Salem, OR, December 2002. <http://www.odot.state.or.us/tddtpau/modeling.html#Gen1>

Freight Analysis, Challenges, Concerns and Future Directions, Federal Highway Administration, Office of Freight Management and Operations, Washington, DC, April 2004.

Freight Informatics: 21st-Century Data Just in Time, Catherine T. Lawson, ITE Journal, December 2004

Freight Performance Measures: A Yardstick for Minnesota's Transportation System, Recommendations of the Minnesota Freight Advisory Committee, Minnesota Department of Transportation, Minneapolis, MN, November 1999.

Freight Rail and the Oregon Economy, Port of Portland, March 2004, [http://www.portlandairportpdx.com/Pdfpop/Freight\\_Rail\\_OR\\_Econ.pdf](http://www.portlandairportpdx.com/Pdfpop/Freight_Rail_OR_Econ.pdf).

Freight Transportation Improvements and the Economy, Federal Highway Administration, Washington, DC, July 2004, [http://www.ops.fhwa.dot.gov/freight/freight\\_analysis/improve\\_econ/index.htm](http://www.ops.fhwa.dot.gov/freight/freight_analysis/improve_econ/index.htm)

Freight Transportation Planning for Urban Areas, Arun Chatterjee, ITE Journal, December 2004

Measuring the Economic Costs of Urban Traffic Congestion to Business, Glen Weisbrod et al, presented at TRB 2003 Annual Meeting

Occupational Employment Projections to 2012, David Hecker, U.S. Department of Labor, Monthly Labor Review, February 2004, Washington, DC <http://stats.bls.gov/opub/mlr/2004/02/art5abs.htm>.

Operational Solutions to Traffic Congestion, Jeff Paniati, Public Roads, November/December 2004.

Paid On-Street Loading Zones: Final Project Proposal, Portland Office of Transportation, May 26, 2000

Perceived Value of Time for Truck Operators, Kazuya Kawamura, presented at TRB Annual Meeting, 1/13/2000

Railroads Raise Rates Despite Long Waits for Delivery Dates, David Greenberg, Los Angeles Business Journal August 16, 2004.

Regional Economic Effects of the I-5 Corridor/Columbia River Crossing Transportation Choke Points, Oregon Department of Transportation, April 2003

Systems Management and Operations: A Culture Shock, Steve Lockwood, ITE Journal, May 2005.

Regional Industrial Lands Study Market Demand Analysis, prepared for the City of Portland Bureau of Planning by ECONorthwest, July 2003, [http://www.pdc.us/pdf/bus\\_serv/mkt-demand-analysis.pdf](http://www.pdc.us/pdf/bus_serv/mkt-demand-analysis.pdf)

The Freight Story: A National Perspective on Enhancing Freight Transportation, U.S. Department of Transportation, Federal Highway Administration, November 2002.

Toll Truckways: A New Path Toward Safer and More Efficient Freight Transportation, Reason Public Policy Institute, Los Angeles, CA, 2002, <http://www.rppi.org/ps294.pdf>

## **Livability**

---

City of Portland Auditor's Service, Efforts and Accomplishments Report, Published 2004

District of Columbia Motor Carrier Management and Threat Assessment Study – Preliminary Findings, U.S. Department of Transportation, Research and Special Programs Administration, October 2003, [http://app.ddot.dc.gov/information/studies/Motor\\_carrier\\_study/pdf/Preliminary\\_Draft.pdf](http://app.ddot.dc.gov/information/studies/Motor_carrier_study/pdf/Preliminary_Draft.pdf)

Industrial Districts Atlas (in progress), Portland Bureau of Planning, January 19, 2005.



Integrating Freight Facilities and Operations with Community Goals, NCHRP No. 320, National Highway Cooperative Research Program, Washington, DC 2003

Railroads: Building a Cleaner Environment, American Association of Railroads, July 2004

---

## Web Sites

American Association of Railroads web site, <http://www.aar.org/>

American Trucking Associations web site, <http://www.truckline.com/index>

Columbia River Crossing web site, <http://www.columbiarivercrossing.org/>

Freight Action Strategy for Seattle-Tacoma (FAST) web site <http://www.wsdot.wa.gov/mobility/fast/>

FHWA Office of Freight Management and Operation web site, <http://www.ops.fhwa.dot.gov/freight/>

I-5 to Delta Park Project web site, <http://www.oregon.gov/ODOT/HWY/REGION1/I-5DeltaPark/index.shtml>

Keep Portland Moving website: <http://www.keepportlandmoving.org/>

Marine Exchange of Southern California web site, [www.mxsocal.org](http://www.mxsocal.org)

Oregon Motor Carrier Division web site, <http://egov.oregon.gov/ODOT/MCT/>

Oregon Freight/Rail Trucking web site, [http://www.oregon.gov/ODOT/rail\\_truck\\_freight.shtml](http://www.oregon.gov/ODOT/rail_truck_freight.shtml)

Portland Office of Transportation Freight web site, <http://www.portlandtransportation.org/Projects/FMP/default.htm>

Port of Portland Channel Deepening web site, [http://www.flypdx.com/ch\\_home.aspx](http://www.flypdx.com/ch_home.aspx)

Port of Portland Marine Terminals Master Plan web site, [http://www.flypdx.com/MTMP\\_Overview.aspx](http://www.flypdx.com/MTMP_Overview.aspx)

Port of Portland Transportation and Trade Studies web site, [http://www.flypdx.com/Trade\\_Trans\\_Studies.aspx](http://www.flypdx.com/Trade_Trans_Studies.aspx)

Sustainable Transportation Monitor Newsletter, [www.cstcd.org](http://www.cstcd.org)

U.S. Dept of Commerce, Bureau of Economic Analysis web site, <http://www.bea.gov/beat/regional/data.htm>

Washington State Department of Transportation Office of Freight Mobility web site, <http://www.wsdot.wa.gov/freight/default.htm>

---

## Data

2002 Commodity Flow Survey, U.S. Department of Transportation, Bureau of Transportation Statistics, Washington, DC, 2004.

2003 Traffic Monitoring Program, Port of Portland, 2004.

Commodity Flow Forecast Update and Lower Columbia River Cargo Forecast, prepared for the Port of Portland, METRO, Oregon Department of Transportation, Port of Vancouver, and the Regional Transportation Council by DRI-WEFA, BST Associates and Cambridge Systematics, Inc., Cambridge, MA, June 2002.

The Women's Shipping Club of Portland, OR Newsletter

---

## Plans

Freight Master Plan Framework Plan Draft, City of Portland Office of Transportation, 5/25/2004

Freight Master Plan: Truck Access and Circulation Analysis, Portland Office of Transportation, September 10, 2003

Freight Mobility Strategic Action Plan, Seattle Department of Transportation, April 2004, <http://www.ci.seattle.wa.us/transportation/docs/FMSAP.pdf>

Intelligent Transportation System Implementation Plan, DKS Associates for City of Portland, June 1997

Oregon Transportation Plan Update: Background Paper – Transportation Security, prepared by Rose Gentry, ODOT, Salem, OR <http://www.oregon.gov/ODOT/TD/TP/docs/otpSafety/Security.pdf>

Oregon Transportation Plan, Oregon Department of Transportation, adopted by the Oregon Transportation Commission in 1992

Portland-Astoria (US 30) Corridor Plan Volume I, Oregon Department of Transportation, Regions 1 and 2, Portland and Salem, adopted by the Oregon Transportation Commission in 1999

Portland-Cannon Beach (US 26) Corridor Plan Volume I, Oregon Department of Transportation, Regions 1 and 2, Portland and Salem, OR adopted by the Oregon Transportation Commission in 1999

Portland International Airport Master Plan, Port of Portland, 2000

Portland International Airport Master Plan, Port of Portland, 2002

Portland Office of Transportation Financial Plan, 2005-2010

Portland Transportation System Plan, by the City of Portland Office of Transportation, adopted by Portland City Council, 1999

## **Standards and Regulations**

---

AASHTO Guide for the Geometric Design of Highways, American Association of State Highway and Transportation Officials(AASHTO), 2001

Laws and Regulations Guidelines for Uniform Laws and Regulations Governing Truck Size and Weight among WASHTO States, adopted by WASHTO Policy Committee, January 2000

ODOT Highway Design Manual, Oregon Department of Transportation, Salem, OR

Regulation of Weights, Lengths, and Widths of Commercial Motor Vehicles -- Special Report 267 Transportation Research Board, Washington, DC, 2002 (TRB) <http://books.nap.edu/books/030907701X/html/212.html#pagetop>

WSDOT Design Manual, Washington State Department of Transportation, Olympia, WA