



North Interstate Corridor

Street Framework Plan, Criteria and
Special Right-of-Way Standards

April 28, 2008
Public Review DRAFT

April 2008
City of Portland
Office of Transportation



CITY OF
PORTLAND
OFFICE OF
TRANSPORTATION



CITY OF PORTLAND
BUREAU OF
PLANNING

Investing in Portland's Future

PDC

PORTLAND DEVELOPMENT COMMISSION

Prepared by

City of Portland, Office of Transportation

Sam Adams, Commissioner
Sue Keil, Director
Steve Townsen, City Engineer
April Bertelsen, Project Manager
Lewis Wardrip, Traffic Engineer
---, Civil Engineer
Oren Eshel, Staff Assistant
April Keithly, Graphics
---, Graphics

Portland Bureau of Planning

Gill Kelley, Bureau Director
Julia Gisler, Project Manager

Portland Development Commission

Bruce Warner, Executive Director
Kevin Cronin, Project Manager

Funding for this document was in part provided by the Portland Development Commission.

To obtain a copy of this document or more information about the project, please contact:

April Bertelsen
Portland Office of Transportation
1120 SW 5th Avenue, Suite 800
Portland, Oregon 97204
(503) 823 – 6177



North Interstate Corridor

Street Framework Plan, Criteria and Special Right-of-Way Standards

April 2008
City of Portland
Office of Transportation



Investing in Portland's Future



ACKNOWLEDGEMENTS

Core Project Technical Group

Courtney Duke, Portland Office of Transportation
Julia Gisler, Bureau of Planning
Mark Raggett, Bureau of Planning
Christine Caruso, Bureau of Development Services
Dawn Hottenroth, Bureau of Environmental Services
Tim Kurtz, Bureau of Environmental Services

Technical Advisors

Kurt Krueger, Portland Office of Transportation
Rich Newlands, Portland Office of Transportation
Tod Rosinbum, Portland Office of Transportation
Nelson Chi, Portland Office of Transportation
Nicole Blanchard, Portland Office of Transportation
Denver Igarta, Portland Office of Transportation

Community Advisory Group

Amy Altenberger, Overlook Neighborhood Association
AlexSandra, Interstate Avenue property owner
Pam Arden, Interstate Corridor Urban Renewal Advisory Committee
Timothy Batog, Kenton Neighborhood Association
Chris Duffy, Arbor Lodge Neighborhood Association
Ethan Edwards, Overlook Neighborhood Association (through March 2007)
Maxine Fitzpatrick, Interstate Corridor Urban Renewal Advisory Committee
Doug Hartman, Interstate Avenue Business Association
David Hassin, developer
Michelle Haynes, REACH Community Development Corporation
Scott Murase, Interstate Avenue property owner
Jenna Padbury, Interstate Avenue property owner
Claire D. Paris, realtor
Tabor Porter, Interstate Avenue property owner
Josh Stein, architect/urban designer
Zach Strachan, developer
Debra S. Vanbaardwyk, Interstate Avenue property owner (through June 2007)
Reg Wobig, Kaiser Permanente
Tanya McGee, member-at-large

CAG Alternates

Libbi Albright, Interstate Avenue property owner
David Davies, Overlook Neighborhood Association
Paul Gouveia, member-at-large
Michele Marx, architect/urban designer
Larry Mills, Interstate Corridor Urban Renewal Advisory Committee
Eric Shreves (through June 2007), realtor

Table of Contents

Overview	7
Background	8
How to Use This Document	9
Background	11
Key Guiding Policy, Plans and Documents	11
Public Planning Process.....	17
Street Framework Plan.....	19
Green Street Opportunities	20
Special Opportunity Areas.....	26
Public Capital Improvement Projects.....	29
Right-of-Way Design Standards.....	33
On-street Parking	33
Street Lighting	33
Sidewalk Corridor Standard Dimension and Design Table.....	39
Sidewalk Standard Cross-sections.....	44
Special Opportunity Areas.....	52
Performance Criteria and Standards	55
Amendment Procedures	60
Standard Plan Specifications	61
 Appendix A: Street Designation and Existing Conditions Matrix	 63

Table of Contents

Overview

Overview

The *North Interstate Corridor Street Framework Plan, Criteria and Special Right-of-Way Standards* are intended to help foster a multi-modal, urban street environment, with emphasis on the pedestrian, bicycle and transit amenities, to support the creation of a vibrant, mixed-use, high density, urban transit corridor.

The special right-of-way standards in this document are a companion tool to the Zoning Code development standards and design guidelines for implementing the vision of the *North Interstate Corridor Plan* through the development review and permitting process. They apply to the public right-of-way within the North Interstate Plan District, as defined by the Portland Zoning Map. This document establishes a common understanding of the improvements required in the public rights-of-way within the North Interstate Corridor. Both private and public street improvements are subject to this document and approval by the City Engineer.

This document attempts to integrate the recommendations of the *Interstate MAX Station Area Revitalization Strategy* (July 2001) with current best practices in pedestrian, bicycle and stormwater management design in support of the City of Portland's recent Green Street Policy, adopted in 2007. The special right-of-way standards focus most on the sidewalk zone between the curb and property line. In a couple Special Opportunity Areas, the standards address the full street cross-section including the roadway and re-alignment of the curbs.

This document does not address all public right-of-way design aspects. Where this document is silent, refer to citywide standards.

This document is not a traffic operations plan. The operational aspects of how the street system is managed, such as traffic control, are guided by Title 16 and Title 17 of the City Code rather than this document.

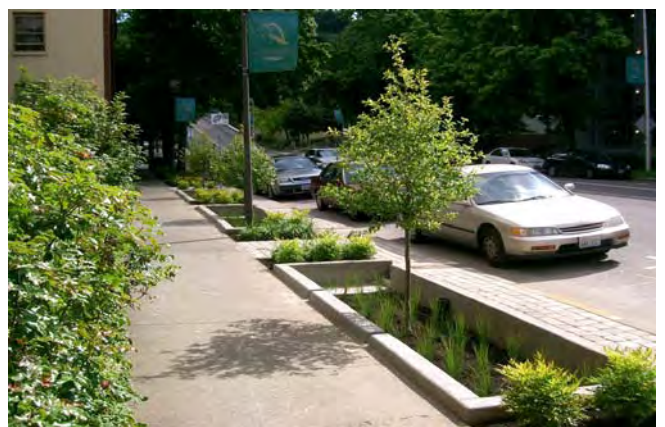

Overview

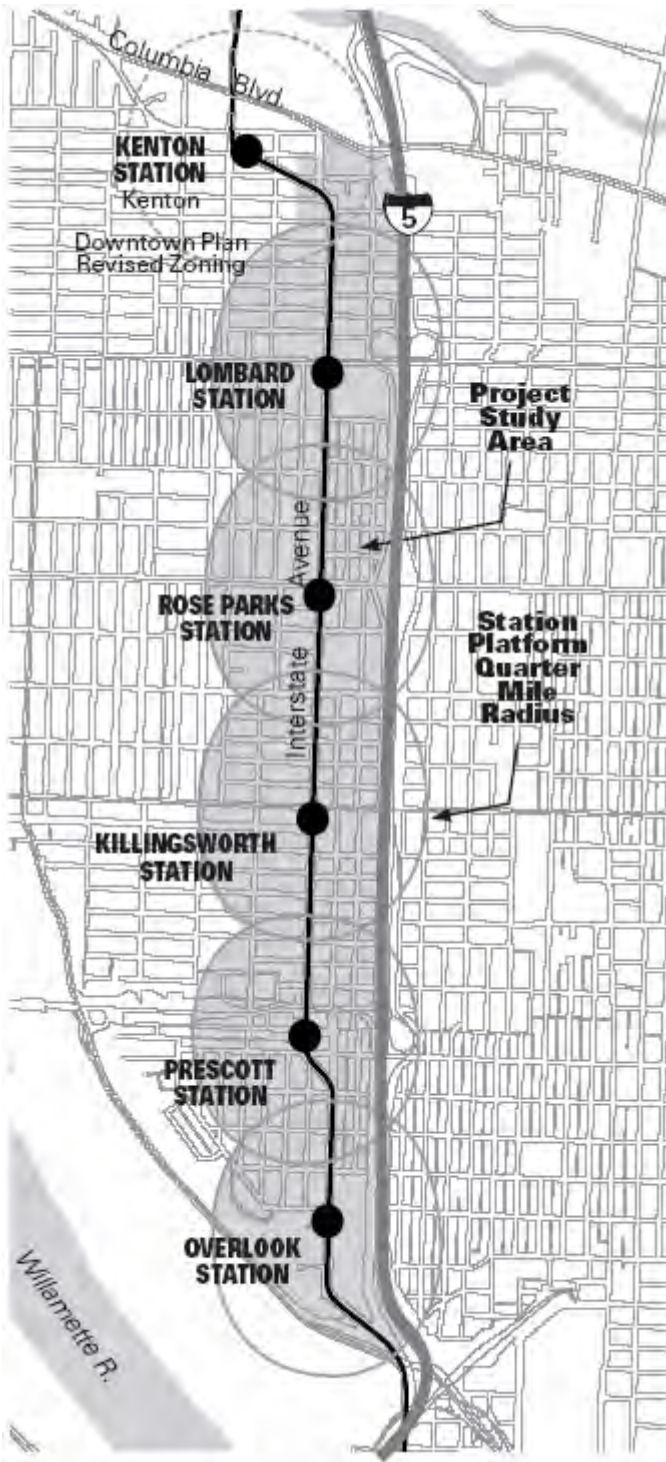

Background

The need for street standards was identified in the *Interstate MAX Station Area Revitalization Strategy* (July 2001). The strategy stated that street improvements identified by the community should be implemented for each light rail station area. It called for creating new street improvement standards or amending existing standards as appropriate. In addition to recommendations about the sidewalk standards for Interstate Avenue, the strategy stated that the design standards should attend to the pedestrian circulation zone, the street furnishing zone (trees, tree grates, bike racks, benches, etc.), landscaping type and location, and paving pattern.

The *North Interstate Corridor Street Framework Plan, Criteria and Special Right-of-Way Standards* were developed by the Portland Office of Transportation during the *North Interstate Corridor Plan* lead by the Bureau of Planning and Portland Development Commission in 2007-2008. Both documents were greatly informed by the *Interstate MAX Station Area Revitalization Strategy* (July 2001).

The full project study area follows the North Interstate MAX light rail alignment. It includes the quarter-mile radius around the Overlook, Prescott, Killingsworth, Rosa Parks and Lombard Stations. The Lombard Station study area also includes the area between Interstate Avenue, the I-5 freeway and Columbia Boulevard not previously included in the Kenton Downtown Plan. The Street Framework Plan addresses the full project study area.

How to Use This Document

How to Use This Document

This document establishes a common understanding of the improvements required in the public rights-of-way within the North Interstate Corridor. Both private and public street improvements are subject to this document and approval by the City Engineer. This document applies to the public right-of-way within the North Interstate Plan District, as defined by the Portland Zoning Map. This document does not address all public right-of-way design aspects. Where this document is silent, refer to citywide standards.

This document is not a traffic operations plan. The operational aspects, of how the street system is managed, such as traffic control, are guided by Title 16 and Title 17 of the City Code rather than this document.

This document is divided into five sections:

- Background
- Street Framework Plan
- Right-of-Way Design Standards
- Procedures
- Standard Plan Specifications

The **Background** section explains why and how the street framework plan and right-of-way design standards were developed. It explains the intent and reasoning behind them and what existing policy, previous plans and current planning efforts helped inform their development.

Readers should review the **Street Framework Plan** before the **Right-of-Way Design Standards** to determine what special designations, and therefore, which special standards apply to a specific location and why.

The **Street Framework Plan** reflects a corridor-wide vision for how streets should function and look based on existing policy and plans, existing conditions, anticipated growth and community desires for how to travel within the corridor by all modes. It identifies a multi-modal street network with designations that indicate which modes should be given priority in street design, and various opportunity areas for increased amenities. It will help guide both public capital investments and private development investments in the public right-of-way by indicating where to focus safety improvements and streetscape amenities.

The **Right-of-Way Design Standards** and **Standard Plan Specifications** provide a more detailed, engineering-level perspective that supplements the City's Standard Construction Specifications and Plans. The performance criteria are intended to guide the design detail of individual right-of-way elements where wither case-by-case design is needed, or flexibility is allowed to encourage streetscape diversity.

The use of these design standards and performance criteria are primarily intended to ensure design continuity of right-of-way improvements over time that reinforce the

How to Use This Document

desired character and function of the string of station areas comprising the Interstate Corridor. The standards and performance criteria themselves are not intended to be inflexible, since unique implementation situations that require some tailoring of the standards are common.

Where a special design standard is not identified for a specific street or street element, the regular City Standard Construction Specifications and Plans apply, as well as the Portland Pedestrian Design Guide, Bicycle Design Guide and Freight Design Guide.

All modifications or exceptions to the design standards and performance criteria require approval from the City Engineer. An appeal of the decision by the City Engineer may also be requested. [Provide direction to correct document and section within PDOT.]

If an exception being requested affects the “look” of the streetscape within the Design Overlay Zone (“d” overlay), the exception is also subject to design review per City Code for non-standard public right-of-way improvements (Zoning Code Section 33.420.041.C). Approval from the City Engineer is a prerequisite to Design Commission review or design staff review.

The **Procedures** section further describes the process for modifying any of the street standards for the whole corridor.

Background

Background

The need for street standards was identified in the *Interstate MAX Station Area Revitalization Strategy* (July 2001). The strategy stated that street improvements identified by the community should be implemented for each light rail station area. It called for creating new street improvement standards or amending existing standards as appropriate. In addition to recommendations about the sidewalk standards for Interstate Avenue, the strategy stated that the design standards should attend to the pedestrian circulation zone, the street furnishing zone (trees, tree grates, bike racks, benches, etc.), landscaping type and location, and paving pattern.

The *North Interstate Corridor Street Framework Plan, Criteria and Special Right-of-Way Standards* were developed by the Portland Office of Transportation during the *North Interstate Corridor Plan* lead by the Bureau of Planning and Portland Development Commission in 2007-2008. Both documents were greatly informed by the *Interstate MAX Station Area Revitalization Strategy* (July 2001).

The *North Interstate Corridor Street Framework Plan, Criteria and Special Right-of-Way Standards* attempt to integrate the recommendations of the *Interstate MAX Station Area Revitalization Strategy* (July 2001) with current best practices in pedestrian, bicycle and stormwater management design in support of the City of Portland's recent Green Street Policy, adopted in 2007.

Key Guiding Policy, Plans and Documents

The following elements helped inform development of street framework plan and special right-of-way standards:

- Interstate MAX Station Area Revitalization Strategy (SARS) Final Report
- Interstate Corridor Urban Design Concept
- Portland Transportation System Plan
- Portland Pedestrian Design Guide
- Bicycle Master Plan Update planning process and proposals
- Existing and proposed Special ROW Standards
- Federal ADA Design Standards and Guidelines
- Portland Green Streets Policy
- BES Stormwater Management Manual and Green Street Details and Specifications

The Street Designation and Existing Conditions Matrix compiles the various designations by street segment from the *Portland Transportation System Plan*, *SARS Report* and *Interstate Corridor Urban Design Concept*, as well as, existing roadway and sidewalk widths. It is located in Appendix A.

Background

To provide more background understanding on the elements informing this document, further description is provided below of corridor-specific plans and recent Green Street policy.

Portland Pedestrian Design Guide (June 1998)

The purpose of the Portland Pedestrian Design Guide is to integrate the wide range of design criteria and practices into a coherent set of new standards and guidelines that, over time, will promote an environment conducive to walking. It is the companion tool to the Portland Pedestrian Master Plan. It is issued by the City Engineer. Every project, both public and private, that is designed and built in the City of Portland should conform to these guidelines. The guide addresses the design of sidewalk corridors, street corners, crosswalks, pathways and stairs. A sidewalk zone system was established in the Portland Pedestrian Design Guide that divided the sidewalk realm into zones, each with its own function and design guidelines. The image below displays the sidewalk zones.

www.portlandonline.com/transportation/index.cfm?c=34955

Sidewalk Zone System from the Portland Pedestrian Design Guide

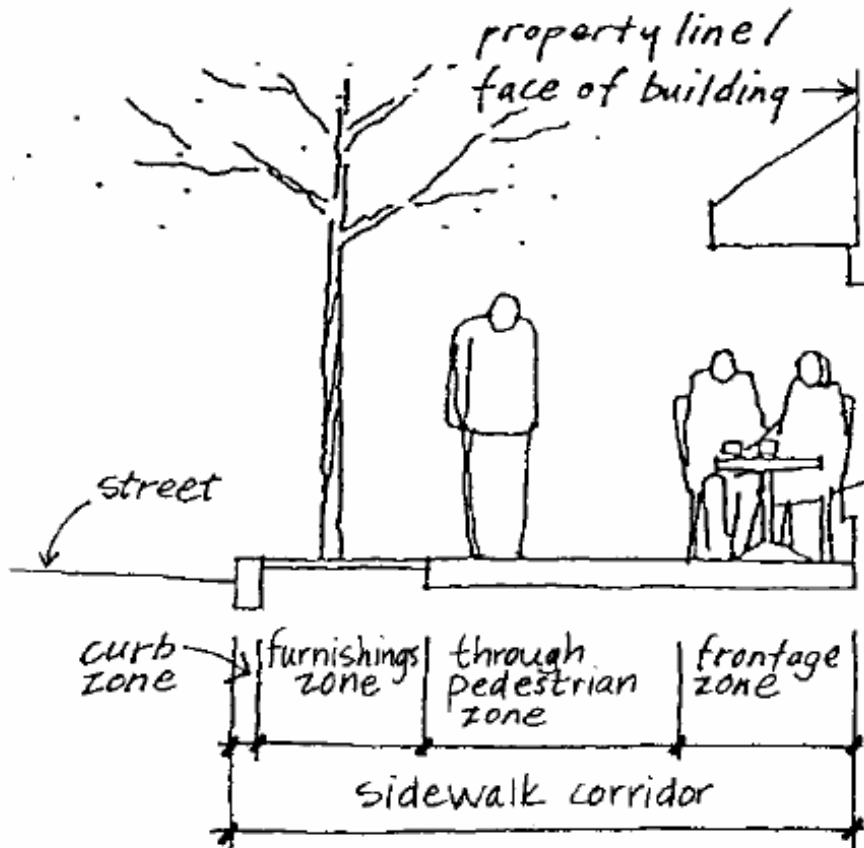

Background

Interstate MAX Station Area Revitalization Strategy (July 2001)

The *Interstate MAX Station Area Revitalization Strategy* (July 2001), often referred to as the “SARS Report,” articulates a community vision for redeveloping key parcels at the six MAX station areas along Interstate Ave, coupled with strategic public infrastructure improvement. The Land Use and Circulation Framework for each station were considered in the development of special right-of-way standards. The report maps identify and describe green streets, pedestrian walkways, gateways/transition, green pedestrian bridges, etc. This vision, while not binding, informed development of special right-of-way standards in the North Interstate Corridor. Link to complete report: www.pdc.us/pubs/inv_detail.asp?id=209&ty=13

Stormwater Management Manual (2004)

The Stormwater Management Manual (SWMM) is a technical document that outlines the City of Portland’s stormwater management requirements. The requirements defined in this manual apply to all development and redevelopment projects within the City of Portland on both private and public property.

The City of Portland’s approach to stormwater management emphasizes the use of vegetated surface facilities to treat and infiltrate stormwater on the property where the stormwater runoff is created. Infiltrating stormwater onsite with vegetated surface facilities is a multi-objective strategy that provides a number of benefits, including but not limited to pollution reduction, volume and peak flow reduction, and groundwater recharge.

Any new redevelopment project will need to comply with disposal requirements of the SWMM, and those projects with over 500 sq feet of impervious surface will need to comply with onsite stormwater management requirements for pollution, volume and flow rate control. www.portlandonline.com/bes/index.cfm?c=35117

BES Green Street Details and Specifications,
www.portlandonline.com/bes/index.cfm?c=44213&

Portland Green Street Policy (2007)

A task force comprised of staff from several City bureaus worked to create an integrated green street policy, adopted by City Council in 2007. A green street’s primary purpose is now to manage stormwater on-site through the use of vegetated facilities. The definition includes streetscape enhancements that improve community and neighborhood livability, including connecting parks, schools, and other public amenities. The transportation aspect of green streets also recognizes the public health benefits of walking and bicycling.

www.portlandonline.com/bes/index.cfm?c=34602&

Background

North Interstate Corridor Plan (2008)

The *North Interstate Corridor Plan* was developed with extensive local public input. It proposed the following planning implementation tools:

- Creation of an Urban Design Concept.
- Amendments to the Comprehensive Plan Map and Zoning Map
- Creation of a North Interstate Plan District with special development standards located in *Title 33: Portland Zoning Code*.
- Application of design review by expanding the designation of the design ‘d’ overlay zone and development of special design guidelines
- Amendments to the Comprehensive Plan Map and Zoning Map designations.
- Development of the *North Interstate Corridor Street Framework Plan, Criteria and Special Right-of-Way Standards*.

The Urban Design Concept represents a vision for future land use and transportation within the plan area that supports the creation of a vibrant, mixed-use, high density, urban transit corridor. It takes into account various elements within the plan area, such as station locations along Interstate, special attractions and amenities, and the nature of smaller residential streets to either side of Interstate. It serves as the basis of the street framework plan and special right-of-way standards. The Urban Design Concept map is provided on the following page. For a full description, refer to the *North Interstate Corridor Plan* available through the Bureau of Planning.

www.portlandonline.com/planning/index.cfm?c=43260

NORTH INTERSTATE CORRIDOR PLAN: URBAN DESIGN CONCEPT

DRAFT 3-24-08



KENTON STATION:
Historic Commercial Gateway
*Not in Project Study Area,
Kenton Downtown Plan adopted 2001*

LOMBARD STATION:
Retail / Employment Anchor

ROSA PARKS STATION:
Neighborhood Corridor

KILLINGSWORTH STATION:
Killingsworth Main Street

PRESCOTT STATION:
Neighborhood Center

OVERLOOK STATION:
Employment Anchor

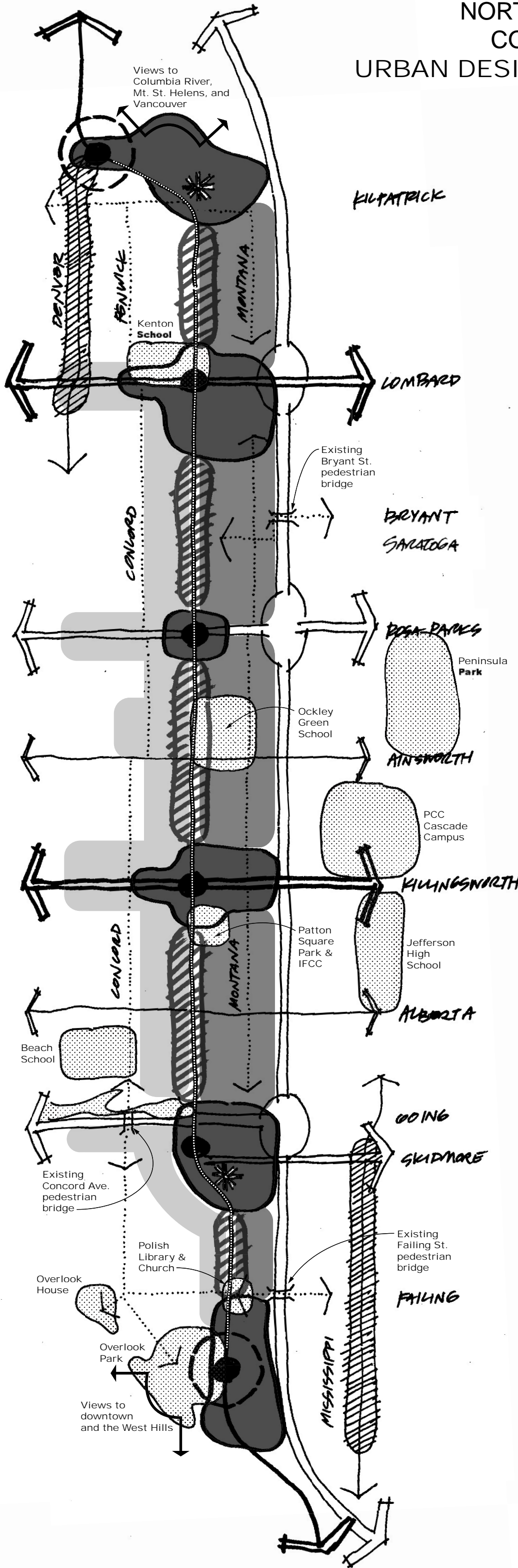

LEGEND

- Station platform area
- Neighborhood east
- Neighborhood west
- Cultural, educational or recreational amenity
- Gateway
- Mixed use area between stations
- Commercial corridor outside project area
- Focal point
- Potential neon sign district

STREETS

- Primary east-west street
- Secondary east-west street
- Local community street
- Pedestrian / bicycle oriented street

Background

Background

Public Planning Process

The public review process for the special right-of-way standards coincides with the public review process for the final zoning and design guideline recommendations of the Interstate Re-zoning Project.

Special right-of-way standards are issued by the City Engineer. They do not require approval of the Planning Commission or City Council. In Design Districts and Historic Districts, the City Engineer typically seeks design advice and input on special right-of-way standards from the Design Commission and Historic Landmarks Commission, respectively.

The planning process and public outreach for the *North Interstate Corridor Plan* presented a good opportunity to engage with stakeholders regarding the public right-of-way as well. While the special right-of-way standards will not be adopted by Planning Commission or City Council, PDOT staff intends to seek advice and input from the community, Planning Commission and Design Commission and City bureau staff on development of special right-of-way standards during the final stages of the *North Interstate Corridor Plan*. PDOT staff has and will continue to participate in the public involvement and public hearing process led by the Bureau of Planning. This includes meeting with the Citizen Advisory Group (CAG), presenting materials and soliciting feedback at public open houses and participating in public hearings between January 2008 and June 2008.

The Citizen Advisory Group played a key role in developing the *North Interstate Corridor Street Framework Plan, Criteria and Special Right-of-Way Standards*. PDOT staff first presented a proposal to develop special right-of-way standards for the North Interstate Corridor to the CAG in January. At subsequent meetings, CAG members gave input on development of the elements of this document, including the Street Framework Plan, sidewalk cross-sections and location and design options for ornamental street lighting. Materials were also presented at the Public Open House on April 10th for review and comment.

Background

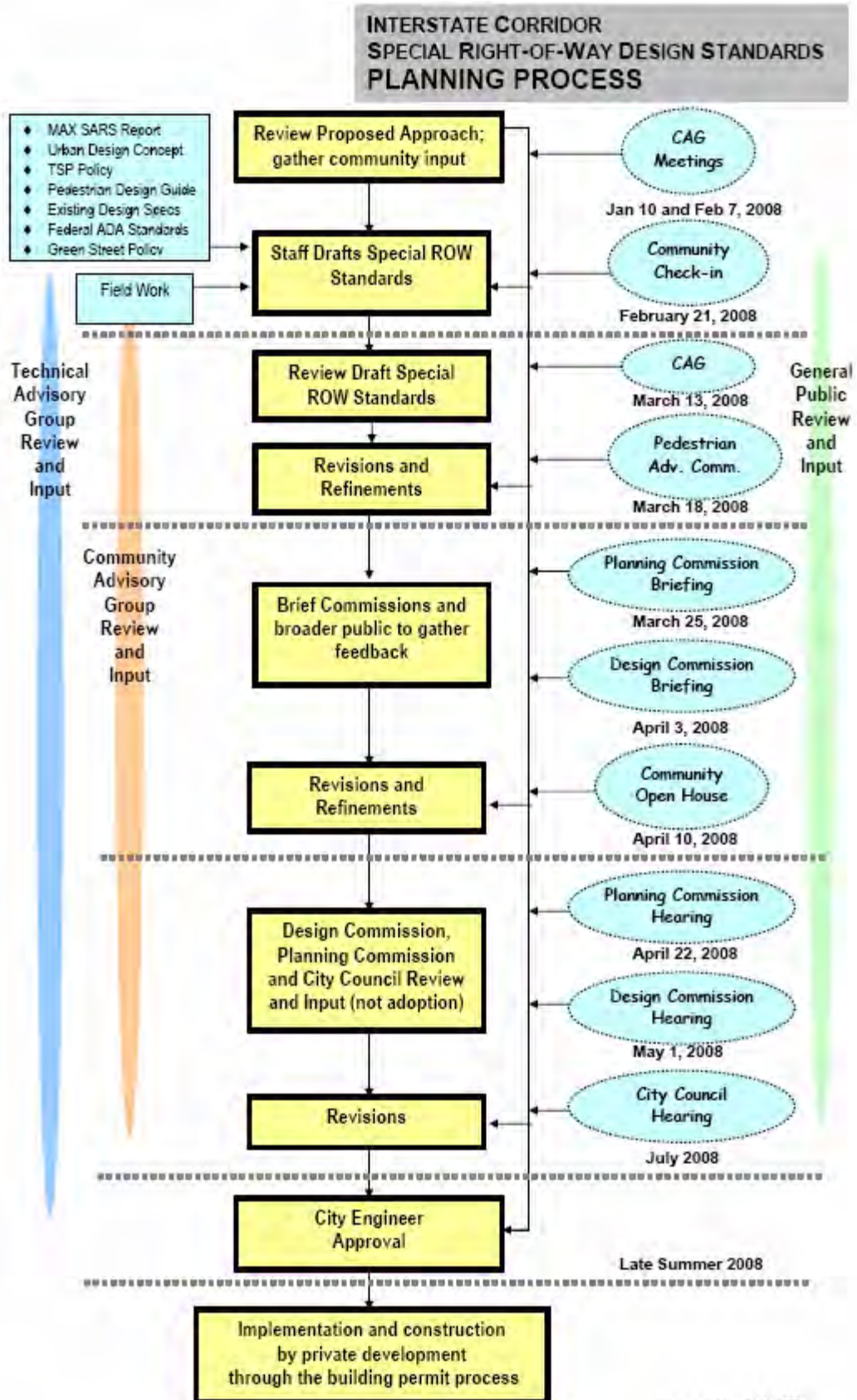

Street Framework Plan

Street Framework Plan

The **Street Framework Plan** reflects a corridor-wide vision for how streets should function and look based on existing policy and plans, existing conditions, anticipated growth and community desires for how to travel within the corridor by all modes. It identifies a multi-modal street network with designations that indicate which modes should be given priority in street design, and various opportunity areas for increased amenities. It will help guide both public capital investments and private development investments in the public right-of-way by indicating where to focus safety improvements and streetscape amenities.

The Street Framework Plan map for the Interstate Corridor is provided on the following folding map insert. The Street Framework Plan includes a street hierarchy grid, gateway opportunities and focal points identified in the *North Interstate Corridor Plan Urban Design Concept*. Interstate Avenue serves as the “Primary Street” in the Corridor. The east-west streets that extend over the I-5 Freeway are identified as either “Secondary Streets” or “Local Community Streets.” These elements are further described in the *North Interstate Corridor Plan*.

The Street Framework Plan identifies Green Street Opportunities for providing stormwater management, Pedestrian and Bicycle Friendly Streets and Special Opportunity Areas. These “Opportunities” reflect locations that show promise for various improvements based on existing conditions, existing policy, plans and community priorities. The designated opportunities do not preclude providing these various elements at other locations. Instead, it reflects locations with the most promise, ease, feasibility and priority.

For example, some segments of N Montana are shaded dark green identifying them as opportunity locations for stormwater sidewalk planter and curb extensions with swales. This is because these segments have wide sidewalk furnishing zones/planter strips that could accommodate stormwater planter boxes with parking access within the existing curb line and other location criteria considered by the Bureau of Environmental Services. Other segments of N Montana are shaded light green identifying them as opportunity locations for just curb extensions with swales. These segments have narrower sidewalk furnishing zones. Yet other segments of N Montana have no shading. This does not preclude stormwater planter boxes or other stormwater facilities being installed in these other locations. However, movement of the curb line or dedication of private property may be required to accommodate such facilities.

Additionally, as facility design evolves, future stormwater management practices may identify facility types that meet all design criteria and overcome current constraints. The *North Interstate Corridor Street Framework Plan, Criteria and Special Right-of-Way Standards* are not intended to preclude such innovations.

As a clarification, the Street Framework Plan designations are not policy designations or street classifications. They are vision concepts and opportunity areas

Street Framework Plan

that may help inform future amendments to street policy classifications in the *Portland Transportation System Plan*.

The Street Designation and Existing Conditions Matrix, located in Appendix A, compiles the various designations by street segment from the *Portland Transportation System Plan*, *SARS Report* and *Interstate Corridor Urban Design Concept*, as well as, existing roadway and sidewalk widths.

Green Street Opportunities

The *Interstate MAX Station Area Revitalization Strategy* (July 2001), often referred to as the “SARS Report,” identifies several “green streets” in the corridor that are now reflected in the Street Framework Plan. The green streets in the SARS Report were intended to connect light rail stations to adjacent neighborhoods with street improvements that create a pleasant, unified pedestrian-oriented environment. They were to include sidewalks, planting strips with turf or groundcover, ornamental street lighting, canopy street trees, on-street parking and landscaped curb extensions at intersections of arterial or collector streets.

Local Green Street Cross-section (SARS Report 2001)

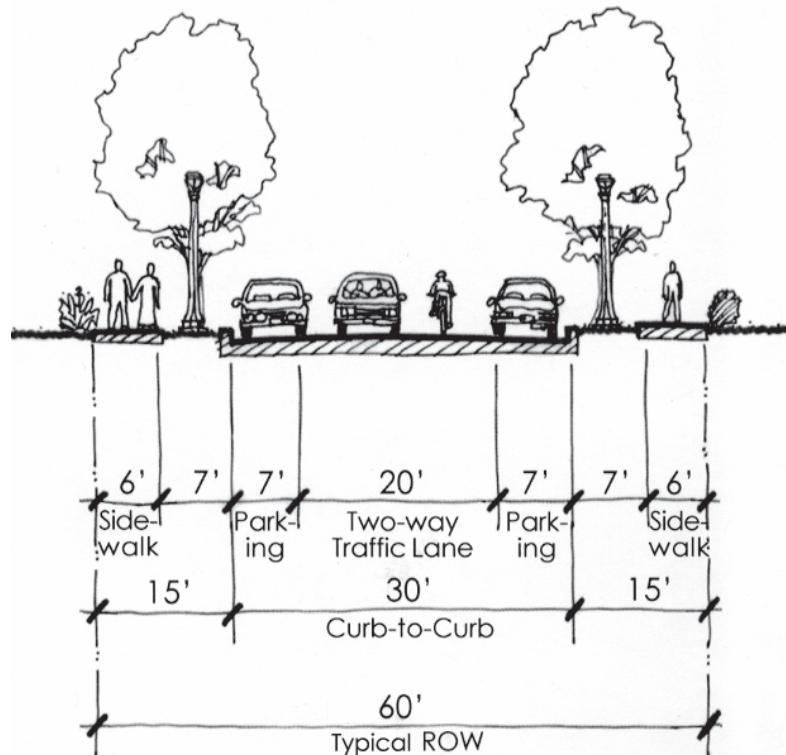

Today, “Green Street” has a different meaning with the adoption of the City’s Green Street Policy in 2007. A Green Street’s primary purpose is now to manage stormwater on-site through the use of vegetated facilities. The definition includes streetscape enhancements that improve community and neighborhood livability, including connecting parks, schools, and other public amenities. The transportation aspect of green streets also recognizes the public health benefits of walking and bicycling.

Street Framework Plan

Examples of Various Types of Green Street Facilities



Stormwater planter box with pervious pavers in continuous on-street parking access strip
 Most appropriate on commercial streets and high density residential streets

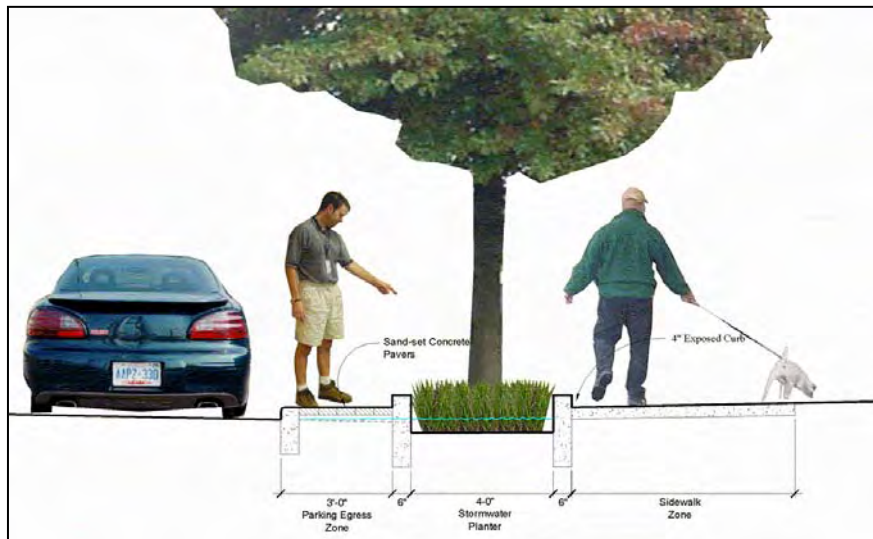
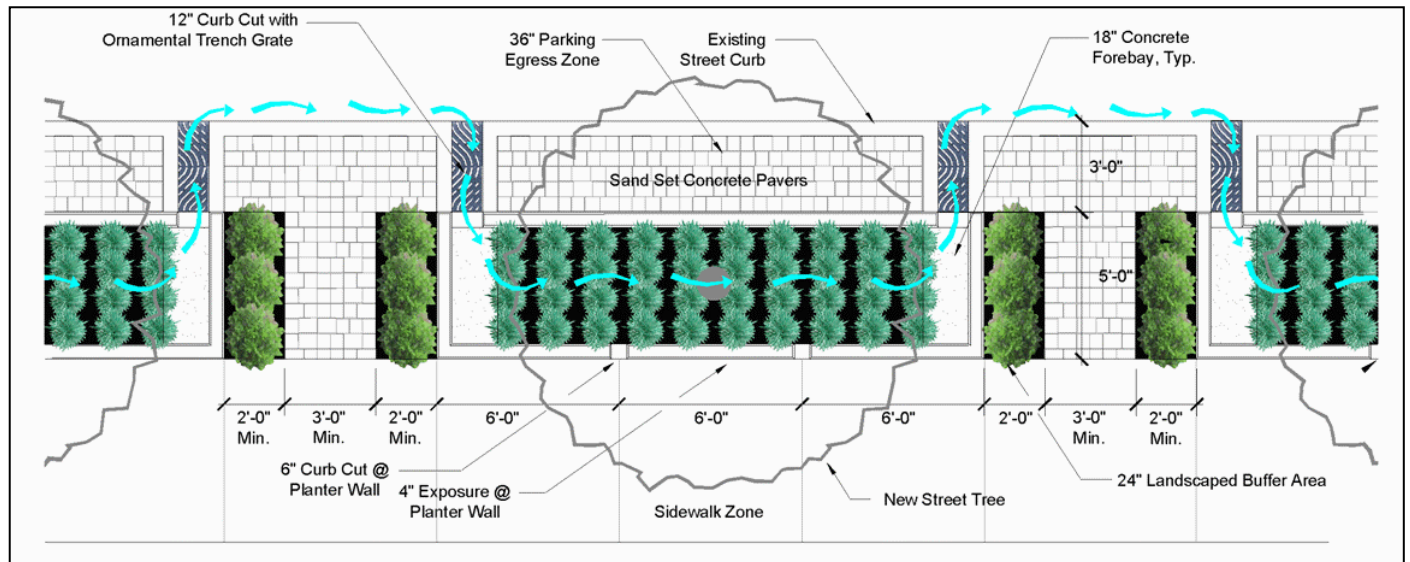

Street Framework Plan

Crosswalk Curb Extensions with Stormwater Swales

Most appropriate on streets with on-street parking



Mid-block Crosswalk Curb Extensions with Stormwater

Most appropriate on streets with on-street parking

“Simple Green Street” swale with limited on- street parking access along a raised landscaped ridge

Appropriate on local
service street with low
density single family
homes



Street Framework Plan



Rain Garden

Appropriate in larger public or private spaces

Pervious pavers in the on-street parking strip



Pervious pavers in the roadway

Most appropriate on local service streets

Porous asphalt in the roadway

Most appropriate on local service streets



Street Framework Plan



N Maryland Ave

The two definitions for Green Streets are not in conflict and often can both be met on the streets designated as pedestrian and bicycle friendly streets. As an added benefit, during the original sub-division platting of the residential blocks in the corridor, many streets were built with wide planting strips in the furnishing zone between the curb and the sidewalk. These planting strips serve as good opportunities to add stormwater management facilities while maintaining access to on-street parking and ample sidewalks with no need to move the curb line. N Montana, N Maryland and N Concord are prime examples of streets with wide furnishing zone and planter strips that could accommodate stormwater facilities, adequate sidewalk widths for pedestrian movement, on-street parking access and serve as quiet, family-friendly pedestrian and bicycle streets.



N Montana Ave

The stormwater management facilities along pedestrian and bicycle friendly streets can also serve as a wayfinding guide. The green street elements would help indicate to people they are on a pedestrian and bicycle friendly route. Therefore, pedestrian and bicycle friendly streets are also designated as green street opportunities, where ample furnishing zones exist or can be reasonably accommodated, or where curb extensions are proposed.

Pedestrian and Bicycle Friendly Streets

The Street Framework Plan identifies pedestrian and bicycle friendly streets where priority should be given to the function of these modes. These streets were identified by community members as already being pretty good streets on which to walk and bike. They are quiet and family-friendly. Many lead to light rail stations and accessible crossings of the light rail tracks on N Interstate Ave, schools, parks, commercial areas and across the I-5 Freeway. Additional crossing enhancements are also identified where needed at intersections with busy streets arterial or collector streets to provide safe crossings.



N Rosa Parks Way

Street Framework Plan

Special Stormwater Management Opportunities

The Street Framework Plan identifies streets with especially good Green Street Opportunities where stormwater management facilities could be located. These streets will be reviewed further by the Bureau of Environmental Services for feasibility. As stated in the section above, many pedestrian and bicycle friendly streets are also designated as stormwater management opportunities, where ample furnishing zones exist or can be reasonably accommodated while maintaining ample space for pedestrians movement and street furnishings, or where curb extensions are proposed. Green Street facilities may be built along other streets not designated on the Street Framework Plan map. The plan simply identifies priority Green Street opportunities.

This document concentrates on the two main stormwater techniques for public right-of-way, namely stormwater planter boxes and curb extensions. Other facilities like swales, rain gardens, tree well planters, porous pavement, and future designs may be approvable on a site by site basis. See the latest version of the Stormwater Management manual at <http://www.portlandonline.com/bes/index.cfm?c=43428>.

Green Street facilities may be built through public capital investment projects, through the permitting process for private development, by private property owners independently or collectively through a Local Improvement District.

Restoring healthy urban watersheds and creating livable vibrant communities is a top priority of the City of Portland. Portland uses multi-objective approaches to achieve these ends. A Green Street is one example that helps to reduce impervious surfaces, replenish groundwater, treat and filter stormwater at its source while supporting regulatory compliance and enhancing watershed health. At the same time, because it is a vegetated system, it can help improve air quality and reduce air temperatures, increase urban green space and habitat, aesthetically improve the streetscape and surroundings, potentially increasing adjacent property values. These vegetated systems can also reduce the cost of underground infrastructure.

Street Framework Plan

Special Opportunity Areas

A few special opportunity areas are designated in the Street Framework Plan. They are further described below.

Prescott Station Main Streets

The streets to the west of the Prescott light rail station have abundantly wide right-of-ways within the internal street grid bounded by Interstate Ave, Going St, and Maryland Ave. In addition, Skidmore St bridges over the I-5 freeway connecting the station area to the Mississippi Ave main street and abutting neighborhood. The total right-of-way is up to 100 feet wide in some blocks. These existing conditions present a rare opportunity to reconfigure the streetscape and create a main street/neighborhood center environment.



Special right-of-way standards for this area are tailored to take advantage of this opportunity. The standards aspire to narrow the currently very wide roadway, improve the pedestrian and cycling environment, provide wider sidewalks to accommodate increased sidewalk activities and street furniture, increase the amount of motor vehicle and bicycle parking, accommodate access and circulation for emergency vehicles and local truck delivery, and provide stormwater management facilities.



Street Framework Plan

N Ainsworth, between Interstate Ave and Maryland Ave

Along N Ainsworth, between Interstate Ave and Maryland Ave, the existing right-of-way is over 100 ft wide. The sidewalk realm varies from 20 or wider. The community identified this area as a Special Opportunity Area where the curb may be moved into the roadway to narrow the roadway, create a gentle transition to the narrow right-of-way east of Maryland Ave and widen the sidewalk realm. This is a great stormwater management opportunity.



N Failing St Pedestrian/Bicycle Bridge

DISCUSS



Street Framework Plan

N Bryant St Pedestrian/Bicycle Bridge

DISCUSS



Montana and Maryland Potential One-way Couplet

Community members have expressed a desire for a one-way couplet on Montana Ave and Maryland Ave between N Rosa Parks Way and N Buffalo St. They also want to preserve on-street parking. Both streets are seen as good biking and walking streets. Both streets are identified as Pedestrian and Bicycle Friendly Streets and Green Street Opportunities. However, there are some concerns about traffic speeding down these two streets.

Whether the streets remain both two-way or become a one-way couplet is a traffic operations decision that can be made independent of special right-of-way design standards. Therefore, the special right-of-way design standards for these streets were developed to support a good multi-modal environment whether the streets are two-way or one-way. This will allow the evaluation of a one-way couplet system and the timing of implementation to occur in different timeframes.

The Portland Office of Transportation has the following concerns with a one-way couplet at this location.

- A one-way couplet would decrease the number of portal access points into and out of the neighborhood. This would decrease overall motor vehicle capacity.
- A one-way couplet would increase diversion of traffic onto other local streets. This increases out of direction travel.
- In the near term, a one-way couplet would increase speeding on the street. The current street configuration with narrow roadways and on-street parking has some traffic calming effect, as drivers need to slow and move into the open parking spaces to let by on-coming vehicles. These conditions would no longer occur under a one-way couplet configuration.

Therefore, in the short-term, a one-way couplet is not recommended.

Street Framework Plan

Since a local one-way couplet would cause traffic diversion, the project first must have support of adjacent property owners. The review process includes majority support in a ballot survey of all adjacent property owners, temporary implementation and evaluation of the one-way couplet and majority support in a follow-up ballot survey. This process can be initiated by residents through the Traffic Investigations Division of the Portland Office of Transportation.

Public Capital Improvement Projects

During the development of the Street Framework Plan, a few street improvement projects were identified that were beyond typical frontage improvements. They would be more appropriate as public capital improvement projects. The majority of the projects are pedestrian and bicycle safety improvements. The public capital improvement projects needed to provide a safe network of pedestrian and bicycle friendly routes in the Interstate Corridor include the following:

- Median island and/or curb extensions crossing of N Ainsworth at Concord.
- Median island and/or curb extensions crossing of N Rosa Parks at Concord.
- Improved pedestrian/bicycle crossing of Lombard in the jog from N Concord to N Fenwick.
- Median island and/or curb extensions crossing of N Ainsworth at Montana.
- Safety and aesthetic improvements to the N Bryant St Pedestrian Bridge, especially street lighting. Improve wayfinding leading to the bridge.
- Increased pedestrian-scale lighting and wider sidewalks on overpasses for streets crossing I-5 Freeway.
- Improve existing un-improved alleys.

Street Framework Plan

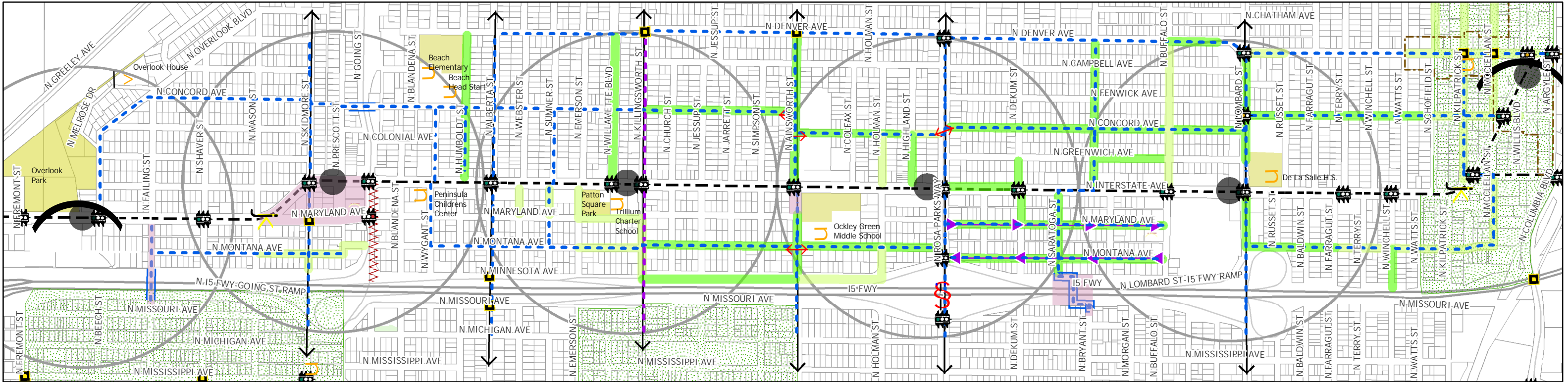

<ul style="list-style-type: none"> MAX Station 1/4 mi Station Area School Fire Station 	<p>Existing Traffic Signals</p> <ul style="list-style-type: none"> Other Intersection Pedestrian Crossing Fire Stations Island Light School Beacon Standard Beacon Walk Illuminated Sign 	<p>Urban Design Concepts</p> <ul style="list-style-type: none"> Primary Framework Street (Interstate) Secondary Framework Streets Gateway Focal Point Community Assets 	<p>Opportunities</p> <ul style="list-style-type: none"> Opportunity Area (includes Green Streets) Bike/Ped Crossing Improvement Pedestrian & Bike Friendly Street Pedestrian Friendly Street Potential Future One-Way Couplet Pedestrian Bridge <p>Potential Stormwater Management Green Streets</p> <ul style="list-style-type: none"> Curb Extension w/Swale Stormwater Sidewalk Planter/Curb Extension w/Swale Transportation Barrier 	<p>District Boundaries</p> <ul style="list-style-type: none"> Kenton Plan District Pedestrian District 	<p>Interstate Corridor Street Framework Plan</p> <p>0 200 400 600 800 1,000 Feet</p>
--	---	---	--	---	---

Street Framework Plan

Right-of-Way Design Standards

Right-of-Way Design Standards

On-street Parking

Generally, on-street parking should be preserved on blocks where it currently exists. The number of spaces may be reduced in order to provide pedestrian curb extensions with stormwater management facilities. In all circumstances, the City Engineer reserves the ability to remove, reconfigure on-street parking or change the parking duration limitation as deemed necessary. Consider angled parking at Prescott light rail station where the right-of-way is wide enough to accommodate it.

Street Lighting

Existing Lighting in the North Interstate Corridor and vicinity

The citywide standard cobra head light fixtures mounted on wood utility poles are installed throughout the district.



Special lighting is installed along the MAX light rail line on N Interstate Avenue.

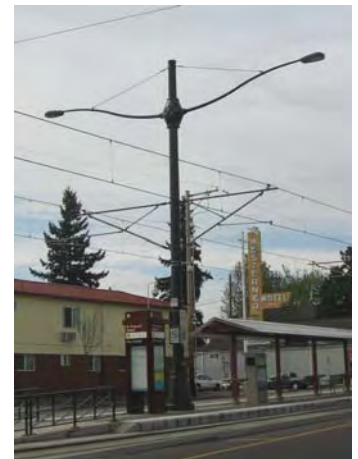

The Lumec Z40 ornamental street light, in black, is being installed on Killingsworth eastward of Interstate Ave.



The Lumec Z42G ornamental street light, in dark green, is located on NE Alberta east of MLK Jr. Blvd.

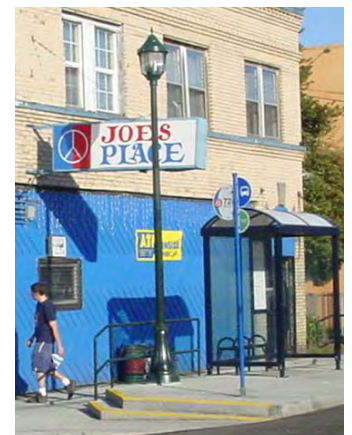

The Lumec Z15 ornamental street light, in Black, shown in the picture to the left, is the preferred lighting fixture proposed on N Denver in Kenton, from N Watts to Interstate Ave.



Right-of-Way Design Standards

Special Ornamental Street Lighting Locations

Street lighting illumination levels are determined by street traffic classification in the Portland Transportation System Plan. Streets are to be illuminated to the PODT citywide standard. Most street lighting in the corridor is provided with cobra fixtures mounted on wood poles. Cobra lighting will continue to be the primary lighting standard in North Interstate Corridor.

In addition, there is a desire for more ornamental, pedestrian scale lighting in the North Interstate Corridor to improve the pedestrian environment at night and enhance the character and identity of corridor. Therefore, ornamental, pedestrian scale lighting is proposed in select locations. Priority was given to Opportunity Areas, as well as, east-west streets that connect across the I-5 Freeway to Interstate Ave and currently have lower lighting standards since they are designated local traffic streets. The locations where special ornamental street lighting is proposed to be installed are displayed on the Proposed Street Lighting Map on page 35. The ornamental street lighting design standards follow.

Ornamental Street Lighting is proposed at the following locations:

- Failing, between Interstate and I-5
- Prescott Station Special Opportunity Area, on Maryland and Prescott
- Skidmore, between Interstate and I-5
- Alberta, between Interstate and I-5
- Killingsworth, between Interstate and Denver
- Ainsworth, between Interstate and I-5
- Denver, N Watts to Interstate, (proposed under N Denver Streetscape Plan)
- N Lombard, between Interstate and Denver

Special Ornamental Street Lighting Design Standard

Exact Special Ornamental Lighting Design Standard are TO BE DETERMINED.

Top three candidate lighting fixtures from the list of PDOT Acceptable Lumec ZED Fixtures:



Z40



Z42G



Z15

Right-of-Way Design Standards

Light Spacing Standard:

Locate ornamental lights on corners and approximately 90 feet apart along block faces between corners.

Potential street light fixture color candidates:

- Black
- Dark Green

Potential light pole candidates:

Option 1: Smooth Steel Pole (Lumec P805 SJ-14)

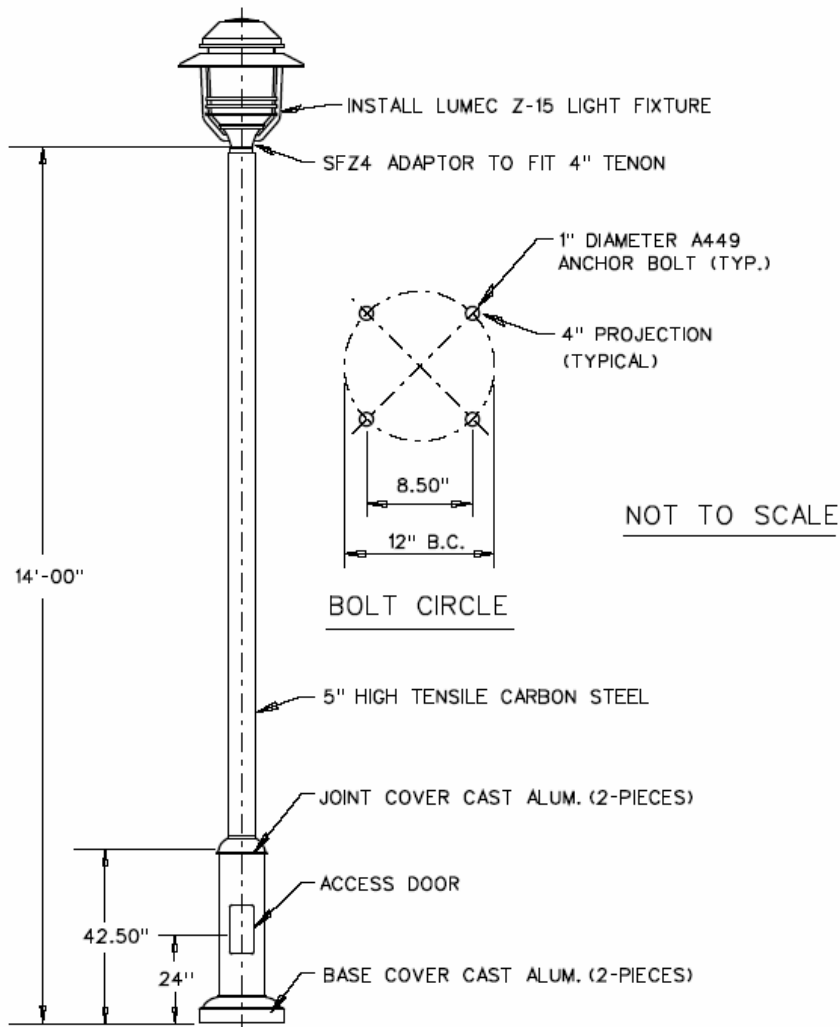

NOT TO SCALE

LUMINAIRE - LUMEC Z15 OR APPROVED EQUAL
POLE - LUMEC P805 SJ-14 OR APPROVED EQUAL

Right-of-Way Design Standards

Option 2: Fluted, Tapered Steel Pole

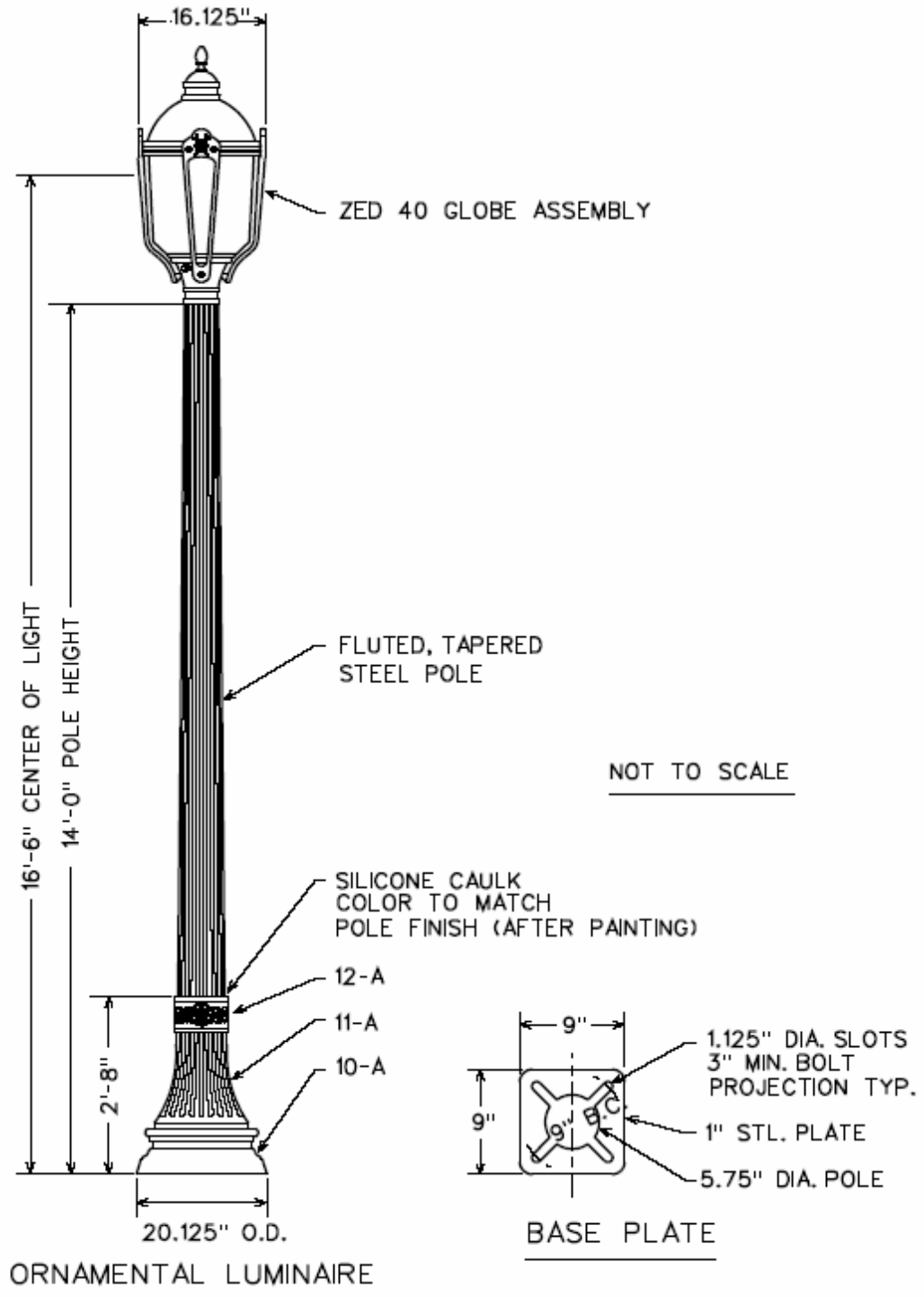



Denver (Rosa Parks - Lombard)
Neighborhood Collector (.5 fc)

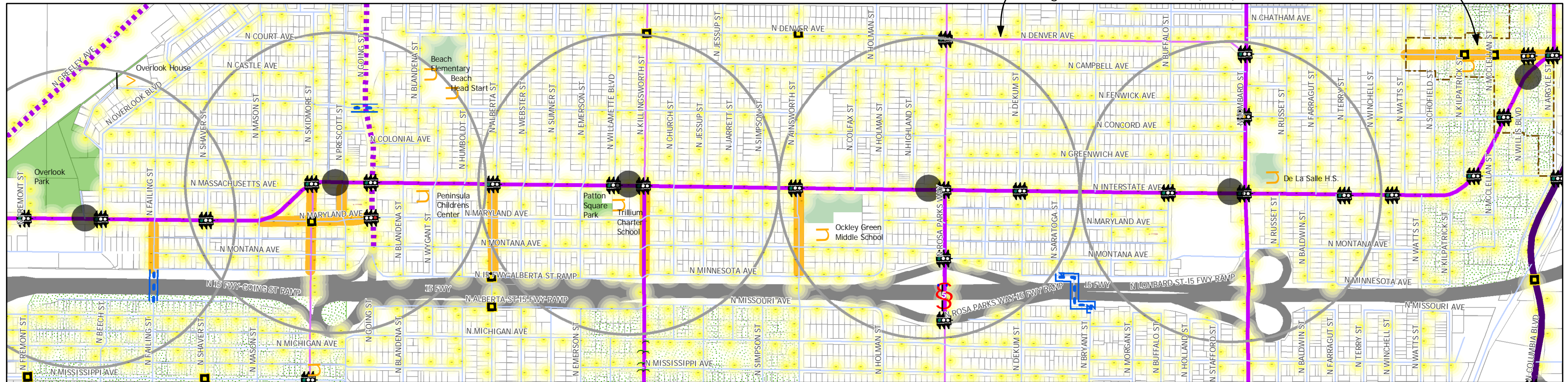

Street Classification	Neighborhood Collector	Local	Neighborhood Collector	Local	District Collector	District Collector	Interstate Ave District Collector (.7 fc)
Typical Illumination in foot-candles (fc)	.5 fc	.2 - .5 fc	.5 fc	.2 - .5 fc	.7 fc	.7 fc	
Existing Special Lighting Standard	Z42G		Z40				

MAX Station

1/4 mi Station Area

School

Fire Station

Community Assets

Pedestrian Bridge

Existing Traffic Signals

- Other
- Intersection
- Pedestrian Crossing
- Fire Stations
- Island Light
- School Beacon
- Standard Beacon
- Walk Illuminated Sign

TSP: Traffic Classes

- Regional Trafficway
- Regional Trafficway & Major City Traffic Street
- Major City Traffic Street
- District Collector Street
- Neighborhood Collector Street
- Local Service Traffic Street

District Boundaries

- Kenton Plan District
- Pedestrian District

Existing Lighting

- Cobra or Other
- Single Ornamental
- Existing Street Light Illumination (Approximate)

Proposed Special Light Locations

- Ornamental Lighting

Interstate Corridor Street Lighting Existing & Proposed

Proposal for Ornamental Pedestrian-scale Street Lighting

Lighting levels are based on a street's traffic classification. All local streets are illuminated to an average .2 - .5 foot-candle lighting level.

Illumination is measured in foot-candles (fc). An overcast day produces a light intensity of about 1000 fc.

0 200 400 600 800 1,000 Feet

Right-of-Way Design Standards

Right-of-Way Design Standards

Sidewalk Corridor Standard Dimension and Design Table

The following reference table lists the public right-of-way sidewalk corridor standard dimensions and special design elements by street in alphabetical order. The respective detailed sidewalk cross-sections are located in the next section where additional design information can be found. The street policy classifications in the Transportation System Plan are also provided in the table below.

Street	TSP Policy Classifications	Public Right-of-Way Sidewalk Corridor Standard Dimensions and Design
Ainsworth	Local Service Traffic Local Service Transit City Bikeway Local Service Walkway Local Service Truck Minor Emergency Response	Special 16-ft to 20-ft Sidewalk Standard Cross-section Ornamental Street Lighting east of Interstate
Alberta	Local Service Traffic Local Service Transit Local Service Bikeway Local Service Walkway Local Service Truck Minor Emergency Response	Typical 12-foot Sidewalk Standard Cross-section Ornamental Street Lighting east of Interstate
Bryant	Local Service Traffic Local Service Transit Local Service Bikeway Local Service Walkway Local Service Truck Minor Emergency Response	Typical 12-foot Sidewalk Standard Cross-section
Buffalo	Local Service Traffic Local Service Transit Local Service Bikeway Local Service Walkway Local Service Truck Minor Emergency Response	Typical 12-foot Sidewalk Standard Cross-section
Concord	Local Service Traffic Local Service Transit Local Service Bikeway City Walkway (Overlook to Blandena) Local Service Walkway (Blandena to Schofield) Pedestrian District (Schofield to Argyle) Local Service Truck Minor Emergency Response	Where existing sidewalk realm is less than 14 ft: Typical 12-foot Sidewalk Standard Cross-section with 4-6 ft furnishing zone Where existing sidewalk realm is 14 ft or more and stormwater planter boxes are added: Local Street Special Wide Sidewalk Standard Cross-section

Right-of-Way Design Standards

Street	TSP Policy Classifications	Public Right-of-Way Sidewalk Corridor Standard Dimensions and Design
Denver	Neighborhood Collector (Rosa Parks to Lombard) Local Service Traffic (otherwise) Transit Access (Rosa Parks to Argyle) Local Service Transit (otherwise) City Bikeway (Willamette Blvd to Argyle) Local Service Bikeway (otherwise) City Walkway Local Service Truck Minor Emergency Response	Where existing sidewalk realm is less than 14 ft: Typical 12-foot Sidewalk Standard Cross-section with 4-6 ft furnishing zone Where existing sidewalk realm is 14 ft or more and stormwater planter boxes are added: Local Street Special Wide Sidewalk Standard Cross-section Ornamental Street Lighting between N Watts and Interstate Ave
Failing	Local Service Traffic Local Service Transit Local Service Bikeway City Walkway Local Service Truck Minor Emergency Response	Typical 12-foot Sidewalk Standard Cross-section Potential Festival Street Ornamental Street Lighting east of Interstate
Fenwick	Local Service Traffic Local Service Transit Local Service Bikeway Local Service Walkway Local Service Truck Minor Emergency Response	Typical 12-foot Sidewalk Standard Cross- section
Fremont	Local Service Traffic Local Service Transit Local Service Bikeway Local Service Walkway Local Service Truck Minor Emergency Response	Typical 12-foot Sidewalk Standard Cross- section
Going	Major City Traffic Street Transit Access Street City Bikeway (Greeley to Interstate Ave) Local Service Bikeway (Interstate to I-5) City Walkway (Greeley to Interstate Ave) Local Service Walkway (Interstate to I-5) Priority Truck Street Major Emergency Response	Typical 12-foot Sidewalk Standard Cross-section

Right-of-Way Design Standards

Street	TSP Policy Classifications	Public Right-of-Way Sidewalk Corridor Standard Dimensions and Design
Greenwich	Local Service Traffic Local Service Transit Local Service Bikeway City Walkway Local Service Truck Minor Emergency Response	Where existing sidewalk realm is less than 14 ft: Typical 12-foot Sidewalk Standard Cross-section with 4-6 ft furnishing zone Where existing sidewalk realm is 14 ft or more and stormwater planter boxes are added: Local Street Special Wide Sidewalk Standard Cross-section
Interstate	District Collector Regional Transitway & Major Transit Priority Street City Bikeway City Walkway Truck Access Street Major Emergency Response	Typical 12-foot Sidewalk Standard Cross-section Planter strip may be narrower than 4 ft wide Where on-street parking is prohibited, stormwater planter boxes are allowed in the Furnishing Zone.
Killingsworth	District Collector Major Transit Priority Street City Bikeway Local Service Bikeway (west of Interstate) City Walkway Truck Access Street Local Service Truck St (west of Interstate) Major Emergency Response	Typical 12-foot Sidewalk Standard Cross-section Ornamental Street Lighting between Denver and I-5
Kilpatrick	Local Service Traffic Transit Access Street City Bikeway Pedestrian District Local Service Truck Minor Emergency Response	Typical 12-foot Sidewalk Standard Cross-section
Lombard	District Collector Major Transit Priority Street City Bikeway City Walkway Truck Access Street Major Emergency Response	Special 15-ft Sidewalk Standard Cross-section Furnishing Zone shall be concrete paving at bus stops. Where on-street parking is prohibited, stormwater planter boxes are allowed in the Furnishing Zone. Ornamental Street Lighting between Denver and I-5

Right-of-Way Design Standards

Street	TSP Policy Classifications	Public Right-of-Way Sidewalk Corridor Standard Dimensions and Design
Maryland	Local Service Traffic Local Service Transit Local Service Bikeway Local Service Walkway Local Service Truck Minor Emergency Response	Where existing sidewalk realm is less than 14 ft: Typical 12-foot Sidewalk Standard Cross-section with 4-6 ft furnishing zone Where existing sidewalk realm is 14 ft or more and stormwater planter boxes are added: Local Street Special Wide Sidewalk Standard Cross-section
McClellan	Local Service Traffic Local Service Transit Local Service Bikeway Pedestrian District Local Service Truck Minor Emergency Response	Typical 12-foot Sidewalk Standard Cross-section
Minnesota	Local Service Traffic Local Service Transit Local Service Bikeway Local Service Walkway Local Service Truck Minor Emergency Response	Typical 12-foot Sidewalk Standard Cross-section
Montana	Local Service Traffic Local Service Transit Local Service Bikeway Local Service Walkway Local Service Truck Minor Emergency Response	Where existing sidewalk realm is less than 14 ft: Typical 12-foot Sidewalk Standard Cross-section with 4-6 ft furnishing zone Where existing sidewalk realm is 14 ft or more and stormwater planter boxes are added: Local Street Special Wide Sidewalk Standard Cross-section
Overlook	Local Service Traffic Local Service Transit Local Service Bikeway Local Service Walkway Local Service Truck Minor Emergency Response	Typical 12-foot Sidewalk Standard Cross-section
Rosa Parks (Portland)	District Collector Transit Access Street City Bikeway City Walkway Truck Access Street Major Emergency Response	Special 20-ft Sidewalk Standard Cross-section Furnishing Zone shall be concrete paving at bus stops. Where on-street parking is prohibited, stormwater planter boxes are allowed in the Furnishing Zone.

Right-of-Way Design Standards

Street	TSP Policy Classifications	Public Right-of-Way Sidewalk Corridor Standard Dimensions and Design
Prescott	Local Service Traffic Local Service Transit Local Service Bikeway Local Service Walkway Local Service Truck Minor Emergency Response	See Special Opportunity Area Plans
Saratoga	Local Service Traffic Local Service Transit Local Service Bikeway Local Service Walkway Local Service Truck Minor Emergency Response	Typical 12-foot Sidewalk Standard Cross-section
Skidmore	Neighborhood Collector (east of Interstate Ave) Local Service Traffic (west of Interstate Ave) Local Service Transit City Bikeway (east of Interstate Ave) Local Service Bikeway (west of Interstate Ave) City Walkway Local Service Truck Minor Emergency Response	Typical 12-foot Sidewalk Standard Cross-section Ornamental Street Lighting east of Interstate

Right-of-Way Design Standards

Sidewalk Standard Cross-sections

As redevelopment occurs through the permitting process or the sidewalk realm is otherwise altered, the sidewalk corridor shall meet one of the following sidewalk standard cross-sections. The overarching objective is to balance all the activities and spatial demands on sidewalk corridors to provide adequate room for all elements. This includes pedestrian accessibility and travel, sidewalk activities such as window shopping and sidewalk cafes, stormwater management, access to on-street parking and street furniture, such as, street lighting, poles, signage, street trees, and bike parking. Below each sidewalk standard cross-section there is a list of locations where it is applies.

Typical 12-foot Sidewalk Standard Cross-section

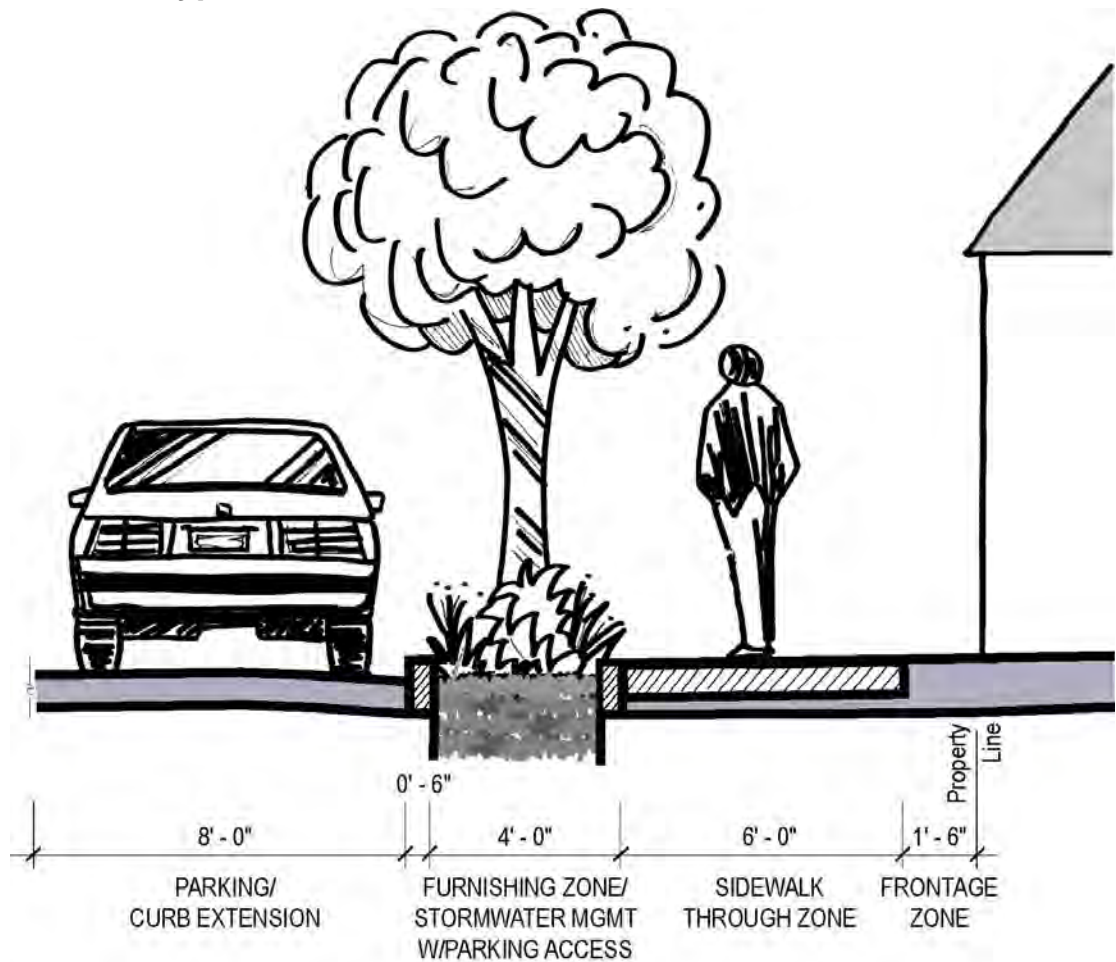

Right-of-Way Design Standards

Locations where the Typical 12-ft Sidewalk Standard Applies:

- Interstate Ave (furnishing zone/planter strip may be narrower than 4 ft)
- Skidmore St
- Alberta St
- Killingsworth St
- Failing, between I-5 and Interstate
- Montana and Maryland south of Killingsworth, except at Prescott Station Special Opp. Area
- Concord, south of Killingsworth
- All Local Streets where the existing sidewalk Right-of-Way is 12 ft or narrower

Features of the Typical 12-ft Sidewalk Standard:

- Meets the recommended sidewalk widths for City Walkways in the Portland Pedestrian Design Guide
- Limits the number of streets where property dedication would be required. Minimizes amount of property dedications where sidewalks are substandard.
- Frontage Zone shall be concrete or pavers on all commercial streets and where residential buildings are built to the property line on residential streets. Frontage Zone may be landscaped on local residential streets where buildings are setback from the property line.
- Tradeoffs: There is limited room for pedestrian movement, street furnishings and stormwater sidewalk planter boxes with parking access. Stormwater management recommended in curb extensions swales, which also improve pedestrian and bicycle crossings. This requires some parking removal.

Private Property Dedication Impacts:

To meet the Typical 12-ft sidewalk Standard, the following private property dedications are required:

- Interstate Ave, various sections
- Skidmore St, between Interstate and I-5 Freeway
- Alberta St, , between Interstate and I-5 Freeway
- Others To Be Determined

Right-of-Way Design Standards

Local Street Special Wide Sidewalk Standard Cross-section (where existing sidewalk realm is 14-feet or wider)

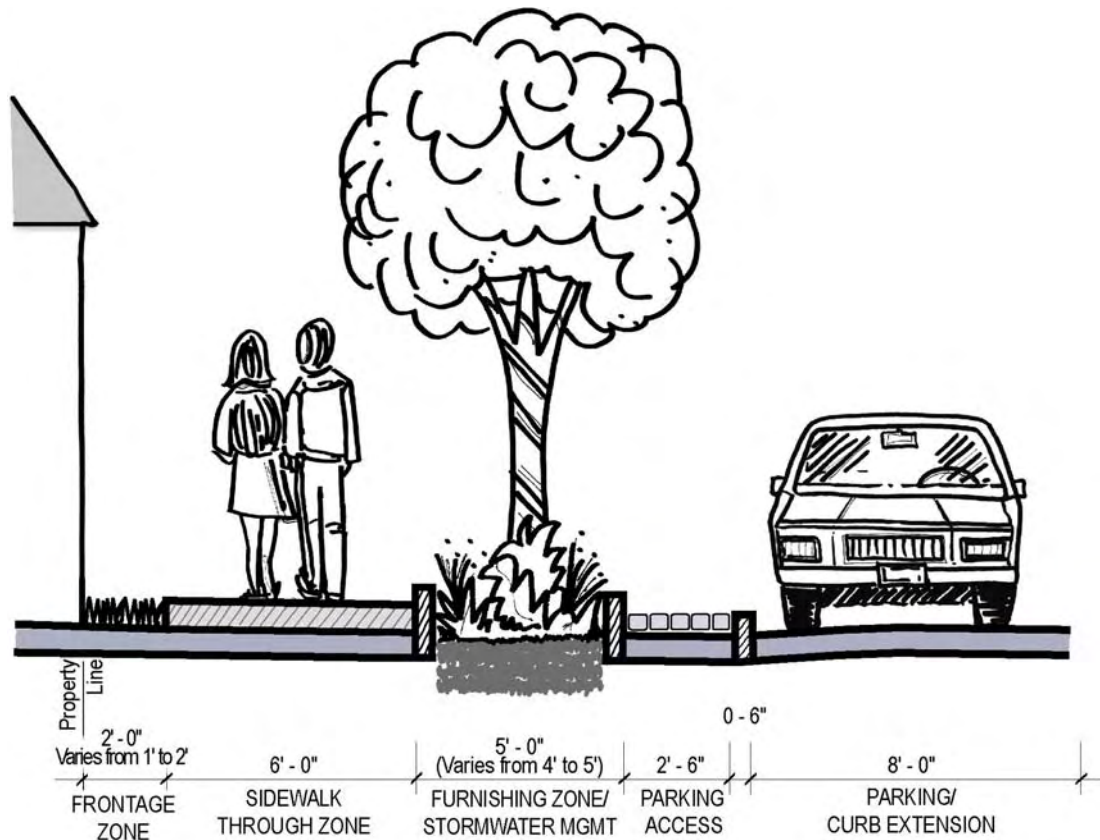

Locations:

- Maryland and Montana, north of Killingsworth
- Concord, north of Killingsworth
- Fenwick, north of Lombard
- All Local Streets, where the existing Right-of-Way is 14 ft or wider.

Features:

- Meets the recommended sidewalk widths for City Walkways
- This sidewalk cross-section fits within the existing Right-of-Way.
- The curb remains.
- There is room for everything!
- Stormwater management can be provided in planter boxes and curb extensions swales
- On-street parking access is maintained
- Ample room remains in the Furnishing Zone for street trees, street lighting, bike racks, other street furniture and stormwater management.
- Furnishing Zone/Stormwater Planter Box width varies based on existing width of sidewalk realm. All other zones to remain consistent.
- Frontage Zone may be concrete or walkable landscape material

Right-of-Way Design Standards

Local Street Special Constrained, Narrow Sidewalk Cross-section

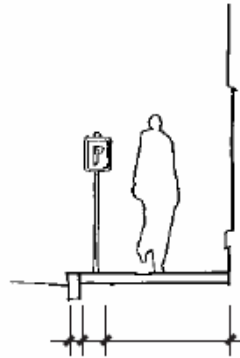

Curb Zone	Furnishings Zone	Through Pedestrian Zone	Frontage Zone
150 mm (0' - 6")	600mm (2' - 0")	1650 mm (5' - 6")	0 m (0' - 0")
	450mm (1' - 6")	1500 mm (5' - 0")	
	300 mm (1' - 0")	1350 mm (4' - 6")	
	0 m	1350 mm (4' - 6")	

Locations where the Sub-standard Sidewalks are Allowed:

- Prescott, between Maryland and I-5 Freeway
- Other locations identified during permit process that meet the criteria below

Criteria for Allowing Constrained, Narrow Sidewalks:

- Steep slopes requiring retaining tall walls (greater than 4 ft high).
- Existing buildings to remain that preclude meeting 12-ft standard.
- Preservation of significant mature trees located adjacent to the sidewalk.

Photo of N Prescott at Montana retaining wall site.

Right-of-Way Design Standards

Constrained, Narrow Sidewalk Design Considerations:

- Try to come as close as is reasonably possible to meeting the Typical 12-ft Sidewalk Standard.
- Refer to the Portland Pedestrian Design Guide for sidewalk zone widths and design guidance.
- At a minimum, provide a 6-ft Pedestrian Through Zone clear of obstructions.

Features:

- Allows for context sensitive and environmentally sensitive design.
- Minimizes the number and amount of private property dedications.
- Tradeoff: As the sidewalk narrows there is less opportunity to accommodate stormwater management facilities. Stormwater management can be provided in tree well facilities or curb extensions swales. Curb extensions improve pedestrian and bicycle crossings. This requires some parking removal.
- Tradeoff: Street trees will not fit in 8-ft or narrower sidewalks

Private Property Dedication Impacts:

To Be Determined. Private property dedication requirements will vary by circumstance.

Right-of-Way Design Standards

N Ainsworth Street: Special 16-ft to 20-ft Sidewalk Standard Cross-section

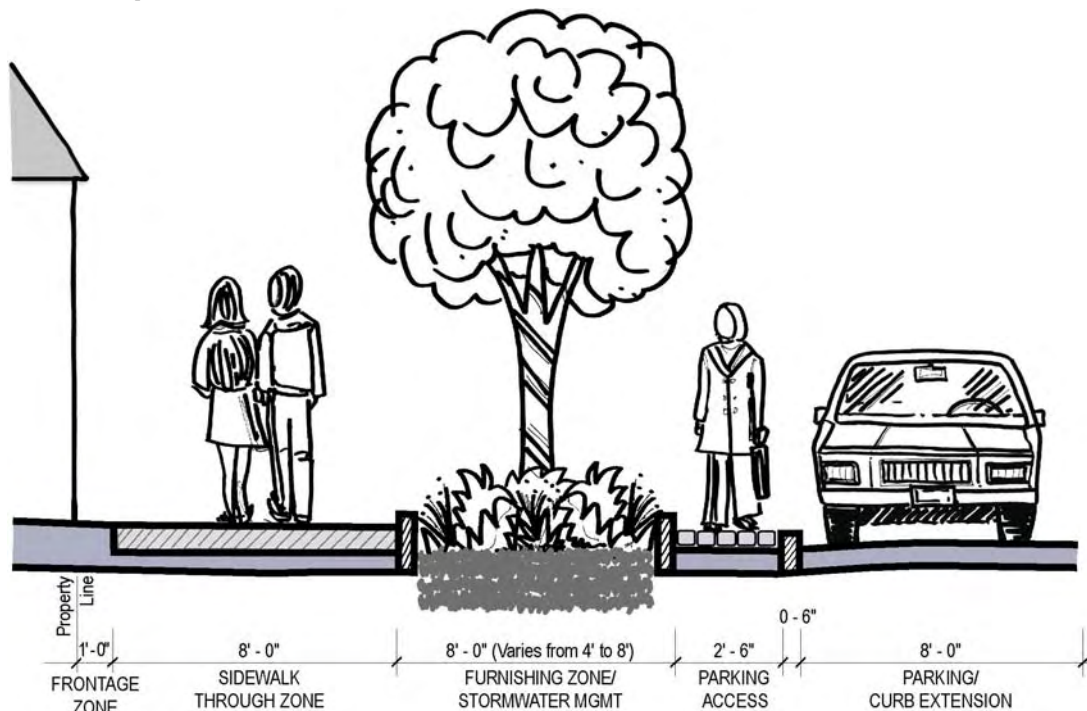

Locations:

- N Ainsworth, between Denver and Interstate and Maryland to I-5 Freeway, the sidewalk realm shall be 16 to 20 ft wide. The Furnishing Zone will vary from 4 ft to 8 ft in width based on available Right-of-Way. Other zones to be consistent.
- N Ainsworth, between Interstate Ave and Maryland Ave, the sidewalk realm shall vary from 20 or wider. This is an Opportunity Area where the curb may be moved into the roadway to make it narrower. Existing ROW is over 100-ft. See Special Opportunity Area Plan View Concepts.
- Consider moving curb to widen roadway and add bike lanes.

Features:

- Exceeds the recommended sidewalk widths for Pedestrian Districts
- This sidewalk cross-section fits within the existing Right-of-Way
- There is room for everything!
- Stormwater management can be provided in planter boxes and curb extensions swales
- On-street parking access is maintained. Use pervious pavers.
- Ample room remains in the Furnishing Zone for street trees, street lighting, bike racks and other street furniture.
- Furnishing Zone/Stormwater Planter Box width varies based on existing width of sidewalk realm. All other zones to remain consistent.
- Frontage Zone may be concrete or walkable landscape material.

Right-of-Way Design Standards

N Rosa Parks Way: Special 20-ft Sidewalk Standard Cross-section

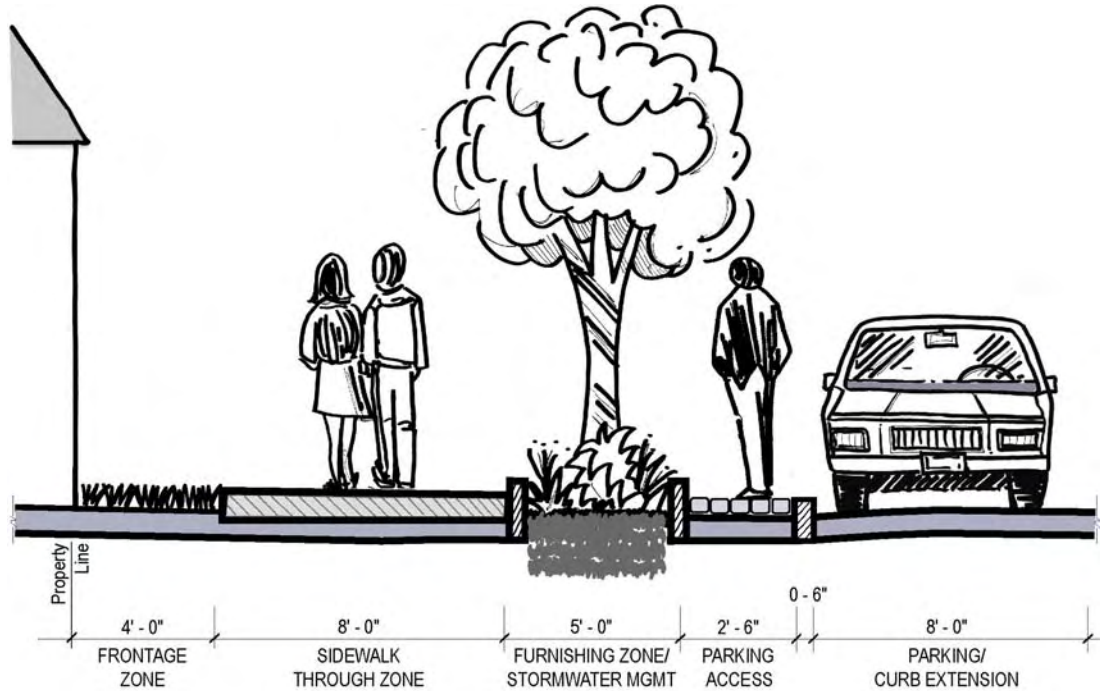

SECTION: ROSA PARKS WAY (PORTLAND BOULEVARD) 20-FOOT SIDEWALK RIGHT-OF-WAY

Locations:

- N Rosa Parks Way, between Denver and I-5 Freeway, the sidewalk realm shall be 20 ft wide

Features:

- Exceeds the recommended sidewalk widths for Pedestrian Districts
- This sidewalk cross-section fits within the existing Right-of-Way. The curb remains.
- There is room for everything.
- Stormwater management can be provided in planter boxes and curb extensions swales
- On-street parking access is maintained. Use pervious pavers.
- Ample room remains in the Furnishing Zone for street trees, street lighting, bike racks and other street furniture
- Frontage Zone may be concrete or walkable landscape material

Right-of-Way Design Standards

N Lombard: Special 15-ft Sidewalk Standard Cross-section

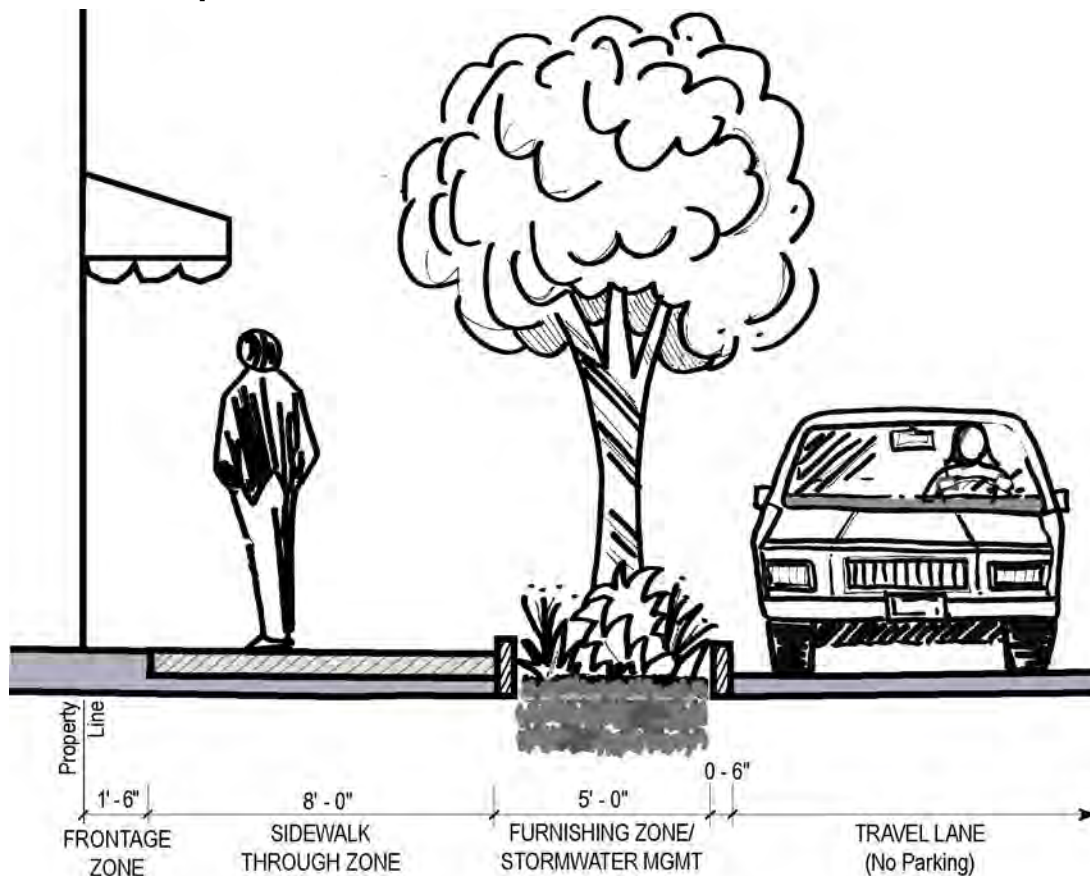

Locations:

- N Lombard, between Denver and I-5 Freeway, the sidewalk realm shall be minimum of 15 ft wide

Features:

- Meets the recommended sidewalk widths for Pedestrian Districts
- This sidewalk cross-section fits within the existing Right-of-Way. The curb remains.
- There is room for everything!
- Stormwater management can be provided in planters adjacent to the curb
- On-street parking prohibitions to remain
- Ample room remains in the Furnishing Zone for street trees, street lighting, bike racks and other street furniture
- Full sidewalk realm to be paved concrete at bus stops and pull-outs to provide ample waiting and maneuvering room for transit riders and pedestrians.
- Frontage Zone shall be concrete or pavers.

Right-of-Way Design Standards

Special Opportunity Areas

Prescott Station Main Streets

Prescott Station Option 1:

No Public Right-of-Way Vacation, Some Private Property Dedication

INSERT Graphic – Graphic too large to insert at this time. It will be on display at the TAC meeting.

Features:

- No Right-of-Way vacation.
- Right-of-Way remains about 100 ft wide on Prescott and Maryland
- Narrows existing very wide roadway by adding angled parking and widening sidewalks
- Maintains truck-friendly roadway widths and turning radii at key corners
- Limits the number of streets where property dedication would be required.
- Minimizes amount of property that must be dedicated in locations where sidewalk realms are substandard (less than 12 ft wide).
- Increased number of parking spaces by providing 90 degree parking on Prescott between Interstate Ave and Maryland Ave and angled parking on Maryland Ave.
- Meets or exceeds the recommended sidewalk widths for Pedestrian Districts on Prescott, between Interstate and Maryland, and Maryland, between Interstate and Going St.
- Meets the recommended sidewalk widths for City Walkways in the Portland Pedestrian Design Guide for all other streets
- Allows for preservation of existing trees
- Wide sidewalks provide room for stormwater planter boxes
- Provides many generous curb extensions to improve pedestrian and bicycle crossings, provide area for sidewalk activities and opportunities for stormwater swales.
- Provides ample sidewalk area for a Bike Oasis

Right-of-Way Design Standards

Prescott Station Option 2: Partial Right-of-Way Vacation (SARS Report Concept)

Note:

Plan concepts are illustrative only and represent no commitment on the part of the property owner or the city to pursue implementation at this time. More refinement is needed to determine roadway dimensions, utility locations and how much Right-of-Way can be vacated under Option 2. **To Be Determined**



Right-of-Way Design Standards

Features:

- Allows for partial Right-of-Way vacation request from adjacent property owners. This would provide for larger developable lots.
- Tradeoff: Less on-street parking would be provided. This concept assumes parallel parking, which provides less parking spaces than 90 degree or angled parking.
- Tradeoff: May not allow for preservation of existing trees.
- Meets the recommended sidewalk widths for City Walkways in the Portland Pedestrian Design Guide for all streets and wider on some block faces.
- Limits the number of streets where property dedication would be required.
- Minimizes amount of property that must be dedicated in locations where sidewalk realms are substandard.

N Ainsworth Special Opportunity Area

Option 1: SARS Report Concept



Option 2: this section is still UNDER CONSTRUCTION

Features:

- N Ainsworth, between Interstate Ave and Maryland Ave, the sidewalk realm shall vary from 20 ft or wider.
- Consider adding bike lanes
- Meets the recommended sidewalk widths for Pedestrian Districts
- This sidewalk cross-section fits within the existing Right-of-Way
- There is room for everything!
- Stormwater management can be provided in planters, rain gardens and/or swales
- On-street parking access is maintained. Use pervious pavers.
- Ample room remains in the Furnishing Zone for street trees, street lighting, bike racks and other street furniture.

Right-of-Way Design Standards

Performance Criteria and Standards

ELEMENTS	CRITERIA AND STANDARDS	
Motor Vehicles	Through Travel Lane Left Turn Lane Mixed Traffic Lane Curbside Parking Curbside Loading Zone Traffic Circles	10-12 feet 10-13 feet 11 feet minimum 7-8 feet (width), 19 feet (length) min. 8 feet minimum The design engineer must refer to other sources and exercise professional judgment in the design of traffic circles.
Bicycles	Conform to Bicycle Master Plan, striped 5' lanes or 6' with concrete gutter. Bus Stop One rack per stop in furnishing zone or as per direction of the City Engineer. Light Rail Station Adequate number of lockers to store eight bicycles, as Per Title 33 Zoning Code. *Place racks outside of automobile door and trunk access paver pads in furnishing zone.	
Transit	Conform to the TriMet Planning and Design for Transit. Interstate Avenue Conform to the standards built by the Interstate MAX Light Rail Project.	
Pedestrian Circulation	Sidewalks will be as wide as possible with 3' modules and defined furnishing, pedestrian through, curb and building frontage zones as indicated on Interstate Corridor Standard Plan Specifications. Unit pavers are an alternative to cast-in-place concrete and landscape materials. Unit pavers should be a Holland Stone rectangular and/or square module, laid in a Herringbone, Basket Weave or Random Blend pattern. <u>Where Unit Pavers are Allowed and Encouraged:</u> In the Sidewalk Furnishing Zone on any street, especially commercial streets with more pedestrian traffic and more street furniture. Where stormwater sidewalk planters are provided in the Sidewalk Furnishing Zone adjacent to on-street parking, unit pavers may be installed in the furnishing zones at automobile door and trunk access locations. They may be installed in curb extensions outside of the Through Pedestrian Zone. <u>Where Unit Pavers are Not Allowed:</u> In the Sidewalk Through Pedestrian Zone on any street, except in special circumstances where approved by the City Engineer. Example: around mature trees with roots that have buckled the sidewalk. Corner ADA Curb Ramps Build corners with two directional curb ramps.	

Right-of-Way Design Standards

ELEMENTS	CRITERIA AND STANDARDS							
<p>Pedestrian Circulation</p>	<p>ADA Detectable Warning Strips</p> <p>Sidewalk Width</p> <p>Sidewalk Materials</p> <p>Sidewalk Scoring Pattern</p> <p>Furnishing Zone Materials</p> <p>Cast Unit Paver Pattern</p> <p>Color</p> <p>Approved Manufacturers</p> <p>Sidewalk Furnishing Zones Over Vaulted Basements</p>	<p>Color: Federal Yellow Manufacturer: -----</p> <p>Depends upon street. See Street Classification and Design Table and Sidewalk Standard Cross-sections</p> <p>Cast-in-place concrete with medium broom finish. (See Detail SWD16)</p> <p>Scoring pattern should delineate the Furnishing Zone, Through Pedestrian Zone and Frontage Zone. The scoring patter for the Through Pedestrian Zone depends upon the width. is</p> <table border="0"> <tr> <td>Through Pedestrian Zone Width:</td> <td>Scoring Pattern:</td> </tr> <tr> <td>6 ft wide</td> <td>3 ft by 3 ft square</td> </tr> <tr> <td>8 ft wide</td> <td>4 ft by 4 ft square</td> </tr> </table> <p>Cast-in-place concrete with medium broom finish. (See Detail SWD16) - or - Holland Stone Concrete Units or approved equal. (See Detail SWD 16)</p> <p>Interlocking patterns: Herringbone, Basket Weave, Random Blend. (See Detail SWD 16)</p> <p>Gray</p> <p>Mutual Materials, Willamette Gray Stone, Western Interlock, Abbotsford, Westcon or approved equal.</p> <p>The furnishing zone may be paved with concrete (in lieu of unit pavers or landscaping) where the zone is over a vaulted basement. Street trees are still required with tree vaults - size to be determined through plan review. Tree well openings (pervious surface area above the tree vault) should be in the range of 4'x6', 4'x9', or 4'x12' subject to approval of the City Engineer.</p>	Through Pedestrian Zone Width:	Scoring Pattern:	6 ft wide	3 ft by 3 ft square	8 ft wide	4 ft by 4 ft square
Through Pedestrian Zone Width:	Scoring Pattern:							
6 ft wide	3 ft by 3 ft square							
8 ft wide	4 ft by 4 ft square							
<p>Street Lighting</p>	<p>Enhance and promote the “Atomic Age,” mid-century image and identity of Interstate Avenue while providing a “controllable” light that won’t over-light view corridors and 2nd/3rd story residences. Use energy efficient lighting fixtures.</p> <p><u>FINISH once ornamental light design standards are chosen.</u></p>							

Right-of-Way Design Standards

ELEMENTS	CRITERIA AND STANDARDS	
Private Utilities	All vault lids, access holes and other utility components should be located in the furnishing zone. All vault and manhole covers must be flush with the walking surface and skid resistant.	
	Underground Utilities:	A utility corridor in a common trench should be provided on all streets. Vault lids and access holes should be aligned with concrete paving patterns. Sawcutting should occur along score lines when repairing or adding utility services.
Public Utilities	All vault lids, access holes and other utility components should be located in the furnishing zone. All vault and manhole covers must be flush with the walking surface and skid resistant.	
	Sewer and Water	Consult the Water Bureau and BES for applicable standards for all streets especially on streetcar/rail streets. Vault lids and access holes should be aligned with concrete paving patterns. Sawcutting should occur along score lines when repairing or adding utility services.
Public Art	Include artists in projects at the onset utilizing the City's 2 percent for art program. Consult with the Regional Arts and Culture Council (RACC) to integrate works of art into the public right-of-way. Potential sites or projects might include gateway design, pedestrian and bicycle friendly streets, special intersections, special streetscape features and design near neighborhood parks, street furnishings, traffic circles, bollards, street signs, inlays, stormwater features, and manhole covers.	
Street Trees	<p>Street trees reinforce the function, right-of-way width and character of each street type. Trees should be of an open habit and of diverse species.</p> <p>On Interstate Ave, ---- is the required tree species, to be spaced at ---- feet. This is the tree species planted by the Interstate MAX Light Rail project. It is the required tree species for Interstate Ave only, to maintain continuity along Interstate Ave, yet distinction from other surrounding streets. Different tree species are to be planted on other streets in the corridor. Specific tree species and sizes shall be reviewed and approved by the Urban Forest Manager.</p>	
Landscaping	Landscaping within the public right-of-way occurs at gateways, medians, traffic circles, curb extensions and in the sidewalk furnishing zone. Landscaping promotes vegetation in urban areas and contributes to the health and aesthetic quality of the City. It can also provide identity by unifying development and enhancing the public right-of-way. Environmentally, landscaping retains storm water runoff and provides cooling during summer months. Landscape areas can help restore natural plant communities through re-establishing native and native-like plants parks or other natural areas. Landscape plantings will promote native and native-like plants (cultivars and hybrid varieties of native species) that help absorb stormwater and maintain porous surfaces.	

Right-of-Way Design Standards

ELEMENTS	CRITERIA AND STANDARDS	
	Maintenance	Maintenance of plantings, landscape materials and irrigation in the public right-of-way will be performed by the adjacent property owner.
	Gateways	Special landscaping shall be designed to enhance the identity of Gateways. A full range of plant material should be used with an emphasis on native and native-like varieties and coordinated with public art.
	Sidewalk Furnishing Zone	The sidewalk furnishing zone is a 4 ft to 9 ft area (except at curb extensions) that lies between the curb and pedestrian through zone. It is often a planted strip. Concrete unit pavers at car door locations, street trees, bike racks, parking meters, street lights and regulatory signage should be located in this zone. Pavers may be utilized with curb extensions. Concrete pavement or unit pavers will be located and centered at loading zones on Local Streets. Landscape plantings should consist of low growing shrubs, perennials, groundcovers or lawn and promote stormwater absorption.
	Sidewalk Furnishing Zones Over Vaulted Basements	The furnishing zone may be paved with concrete (in lieu of unit pavers or landscaping) where the zone is over a vaulted basement. Street trees are still required with tree vaults - size to be determined through plan review. Tree well openings (pervious surface area above the tree vault) should be in the range of 4'x6', 4'x9' or 4'x12' subject to approval of the City Engineer.
Green Streets	<p data-bbox="462 1234 1437 1417">The two most common vegetated stormwater facilities are curb extension with swales and stormwater sidewalk planters with on-street parking access in the Sidewalk Furnishing Zone. There are other options as well, for example rain gardens, simple swales and pervious pavers. Designs include layered plantings that achieve stormwater management goals and integrate with ground floor uses such as cafes, restaurants, shops and residential frontages.</p> <p data-bbox="462 1444 1437 1507">Where stormwater sidewalk planters are located in the Sidewalk Furnishing Zone, the following guidelines apply:</p> <ul data-bbox="511 1512 1437 1873" style="list-style-type: none"> <li data-bbox="511 1512 1437 1753">• Minimum Through Pedestrian Zone. Generally, a minimum six (6) feet wide Through Pedestrian Zone should be provided in addition to the designated frontage zone, which may also paved where deemed appropriate. The Through Pedestrian Zone should be even wider to accommodate greater pedestrian traffic and commercial activity in special designated areas, as identified in the Performance Criteria and Standards Table at the end of the section. In these cases the Through Pedestrian Zone is typically eight (8) feet wide. <li data-bbox="511 1759 1437 1873">• Distance between stormwater sidewalk planters. Generally, the distance between stormwater sidewalk planters (including boarder landscaping) should be a minimum of ten (10) feet, more space is preferred, to accommodate other street furniture that belongs in the 	

Right-of-Way Design Standards

ELEMENTS	CRITERIA AND STANDARDS	
	<p>Furnishing Zone and still provide pedestrian access to parking vehicles, including bicycle parking. Where there are significant constraints, the distance between sidewalk planters and boarder landscaping may be reduced to a minimum of there (3) feet.</p> <p>INSERT Graphic Illustrating the preferred widths described above.</p>	
<p>Street Furniture</p>	<p>The intent is to have consistency of standards throughout the entire district for all street furniture. Maintenance of these furniture amenities (benches, thrash receptacles, banners, bollards, etc.) would be required of the adjacent property owner.</p>	
	<p>Benches</p>	<p>To be determined series series or approved equal. Subject to revocable permit review.</p>
	<p>Trash Receptacles</p>	<p>To be determined series or approved equal. Subject to revocable permit review.</p>
	<p>Street Name Signs</p> <p>Paint Color</p>	<p>Follow City of Portland Standards</p> <p>Black, Wasser Code: W21.79 or approved equal</p> <ul style="list-style-type: none"> • Traffic signal poles • Street light poles • Light rail strain poles • Bus shelters • Benches • Bollards (if painted)
<p>Constructability and Maintenance</p>	<p>Align paving patterns that allow ease of access and minimize sawcuts necessary for utilities, maintenance and repairs.</p>	

Procedures

Amendment Procedures

One of the guiding principles behind development of street standards for an entire district is that they remain consistent over time and throughout the area. This process allows for a uniformity of the look and character of the street network and helps give a unique identity to the area. In the future, it might be desirable to modify the adopted standards for the district.

Any modifications made to North Interstate Corridor Right-of-Way Design Standards, or Street Standards, would apply to the entire district, and not just an individual project or development. There would be a limited number of circumstances under which the street standards for this district would be modified. In all cases, modifications or changes to the street standards would fall within the purview of the City Engineer.

When applying the Street Standards the City Engineer may identify a need for correction or clarification to the drawings or text. The Street Standards may be updated to account for any needed corrections or clarifications at the discretion of the City Engineer. If such correction or clarification does not change the look or intent of the Street Standards, the City Engineer may modify the Street Standards to provide the required clarity.

Similarly, if there is a request for a change in District standards that would alter construction means or methods, without altering the “look” of the streetscape, then the decision for change in a standard would fall within the purview of the City Engineer. Such requests would be reviewed against current practices and evaluated for their impact and their success in meeting all of the City’s various goals and district plan and design principles.

The third instance would be due to a modification in the City’s standard specifications, such as a materials change resulting from emerging/new technology. This approval requires the City Engineer with advice from the Design Commission.

If a significant change in standards citywide is directed by the City Engineer, then PDOT would need an administrative review of all the district-specific standards (Lloyd, River and South Waterfront). The design review process would involve Bureau of Parks, PDC, PDOT, BES, BOP, BDS, the designers and other selected City and private property representatives and would include briefing the Design Commission. The purpose of the review would be to identify and correct any items in the district-specific standards which would be in conflict with the new standard or standards being adopted citywide.

If the request for change in a standard affects the “look” of the streetscape, it must be evaluated by the City Engineer for technical merit. If the City Engineer supports the change upon completion of the evaluation, the modifications will be subject to Design Review as per any nonstandard improvements in the public right-of-way. The Interstate Urban Renewal Advisory Committee, neighborhood association and all other interested parties may provide input/testimony to the public Design Review process.

Standard Plan Specifications

Standard Plan Specifications

This section is still under construction

INSERT Standard Plan Specification Drawings to be completed by Civil Engineers.

Standard Plan Specifications

Appendix A

Appendix A: Street Designation and Existing Conditions Matrix

Appendix A

Interstate Corridor Special ROW Standards

Existing Conditions Matrix

Street	Extent	Direction	Station Area	Green Street (SARS)	Urban Street (SARS)	Arterial Improvements (SARS)	Pedestrian Walkway (SARS)	Gateway/Transition (SARS)	Green Pedestrian Bridge (SARS)	Green Bridge (SARS)	Freeway Bridge (SARS)	TSP Traffic Designation	TSP Transit Designation	TSP Bicycle Designation	TSP Pedestrian Designation	TSP Freight Designation	Interstate Corridor Urban Design Concept	Existing Roadway Width	Existing Sidewalk Zones
Ainsworth	Denver to Interstate	E-W	3 - Killingsworth	X								local	local	Bikeway	local	local	Secondary St	40 ft	13-6-1 ft
Ainsworth	Interstate to Maryland	E-W	3 - Killingsworth	X								local	local	Bikeway	local	local	Secondary St	70 ft	13-6-1 ft
Ainsworth	Maryland to I-5	E-W	3 - Killingsworth	X								local	local	Bikeway	local	local	Secondary St	44 ft	11-6-1 ft
Alberta	Concord to Interstate	E-W	2 - Prescott	X								local	local	local	local	local	Secondary St	36 ft	4-6-2 ft
Alberta	Interstate to Montana/I-5	E-W	2 - Prescott	X								local	local	local	local	local	Secondary St	44 ft	0-6-2 ft
Bryant	Denver to Interstate	E-W	4 - Portland			X						Local	Local	Local	Local	local			
Buffalo	Denver to Interstate	E-W	5 - Lombard	X								Local	Local	Local	Local	Local		28-32 ft	???, "curb-only", 4-5-2 ft
Buffalo	Interstate to I-5	E-W	5 - Lombard	X								Local	Local	Local	Local	Local		33.5-36 ft	N: 0-12-0, S: 5-5-2 ft
Concord	Blandena to Humboldt	N-S	1 - Overlook - Prescott	X								local	local	local	local	local		24 ft	W: 0-11-7/0-16-2, E: 11-5-2
Concord	Going (Bridge)	N-S	2 - Prescott						X			local	local	local	Walkway	local	Tertiary St	40 ft	??
Concord	Going to Blandena	N-S	1 - Overlook - Prescott	X								local	local	local	Walkway	local		24 ft	11-5-2 ft
Concord	Humboldt to Alberta	N-S	1 - Overlook - Prescott	X								local	local	local	local	local		36 ft	5-7-0, 5-6-1 ft
Concord	Overlook House to Shaver	N-S	1 - Overlook - Prescott	X								local	local	local	Walkway	local		26 ft	9-6-2 ft
Concord	Rosa Parks to Lombard	N-S	2 - Prescott									local	local	local	local	local	Tertiary St	28 ft	11-5-2 ft or 9-5-2 ft or 8-6-2 ft
Concord	Shaver to Skidmore	N-S	1 - Overlook - Prescott	X								local	local	local	Walkway	local		36 ft	5.4-6-0.4 to 6-6-0 ft
Concord	Skidmore to Going	N-S	1 - Overlook - Prescott	X								local	local	local	Walkway	local		30 ft	4-5-1 ft
Denver	~Alberta to Killingsworth	N-S	3 - Killingsworth - Lombard	X								Local	Local	Local	Walkway	Local		32-34 ft	4-6-2 ft
Denver	Bryant to Lombard	N-S	3 - Killingsworth - Lombard	X								Neigh Collector	Access	Bikeway	Walkway	Local		50 ft	8-6-1 ft
Denver	Killingsworth to Rosa Parks	N-S	3 - Killingsworth - Lombard	X								Local	Local	Bikeway	Walkway	Local		50 ft	11.5-6-2 ft
Denver	Lombard to ~Farragut	N-S	3 - Killingsworth - Lombard	X								Local	Access	Bikeway	Walkway	Local		60 ft	4-6-2 ft
Denver	Rosa Parks to Bryant	N-S	3 - Killingsworth - Lombard	X								Neigh Collector	Access	Bikeway	Walkway	Local		42 ft	8-6-1 ft
Failing	Interstate to I-5	E-W	1 - Overlook	X								local	local	local	Walkway	Local	Secondary St	36 ft	4-6-2 ft
Fremont	Overlook Park to Interstate	E-W	1 - Overlook									local	local	local	Local	local		40 ft	0-5-0 (curb only), 0-5-15 ft
Going	Greeley to Interstate	E-W	2 - Prescott			X						Major	Access	Bikeway	Walkway	Priority	Secondary St	70 ft	N: 5-8-var, S: ???
Going	Interstate to Montana	E-W	2 - Prescott			X						Major	Access	local	local	Priority	Secondary St	55 ft	N: 5-6-1, S: 0-10-12/none?
Going/Interstate		E-W	2 - Prescott				X					Major	Access	Bikeway	Walkway	Priority	Secondary St	66 ft	N: 5-6-1, S: 0-12-0
Greenwich	Rosa Parks to Lombard	N-S	2 - Prescott									local	local	local	Walkway	local	Tertiary St	24-28 ft	9-5-2 ft or 9-6-1 ft or 8-6-2 ft
Interstate	Study Area		Interstate														Primary St		varies: generally 4-6 ft
Killingsworth	Concord to Interstate	E-W	3 - Killingsworth	X								Neigh Collector	Priority	Local	Walkway	local	Secondary St	36 ft	4-6-2 ft
Killingsworth	Interstate to I-5/Missouri	E-W	3 - Killingsworth		X							District Collector	Priority	Bikeway	Walkway	Access	Secondary St	46/48 ft	N: 0-15-0, 3.5-9-0, 6-6-0 ft S: 0-15.5-0, 3.5-9.5-0, 6-7-0 ft
Lombard	~Denver to Interstate	E-W	5 - Lombard		X							District Collector	Priority	Bikeway	Walkway	Access	Secondary St	52 ft	7-6-2/0-15-0/0-13-2
Lombard	Interstate	E-W	5 - Lombard		X							District Collector	Priority	Bikeway	Walkway	Access	Secondary St	60/56.5 ft	varies
Lombard	Interstate to I-5	E-W	5 - Lombard		X							District Collector	Priority	Bikeway	Walkway	Access	Secondary St	56 ft	N: 7-6-2, S: 0-12-0
Maryland	Mason to Going	N-S	2 - Prescott		X							local	local	local	local	local	Tertiary St	24 ft	0-6-2 ft
Maryland	Rosa Parks to Buffalo	N-S	2 - Prescott		X							local	local	local	local	local	Tertiary St	28 ft	9-5-2 ft
Minnesota	?																		
Montana	?																Tertiary St		
Montana	Rosa Parks to Buffalo	N-S	4 - Portland														Tertiary (Propose)	28 ft	9-5-2 ft
Montana		N-S	2 - Prescott														Tertiary (Propose)	28 ft	9-5-2 ft
Overlook	Interstate to Concord	E-W	1 - Overlook	X								local	local	local	Walkway	local		30 ft	7-6-2 ft
Prescott	Interstate to Maryland	E-W	2 - Prescott		X							local	local	local	local	local		80 ft	N: 0-6-2, S: 4-5-3 ft
Saratoga	Interstate to I-5	E-W	4 - Portland																
Skidmore	Concord to Interstate	E-W	2 - Prescott	X								local	local	local	Walkway	local	Secondary St	28 ft	8-6-2 ft
Skidmore	Interstate to Montana	E-W	2 - Prescott		X							Neigh Collector	local	Bikeway	Walkway	local	Secondary St	44 ft	0-6-2 ft

Appendix A
