



# Newport

## Pedestrian and Bicycle Plan



DRAFTLY  
October 2008



# **FUNDING ACKNOWLEDGEMENTS**

**The Newport Pedestrian and Bicycle Plan was partially funded by a grant from the Transportation and Growth Management (TGM) Program, a joint program of the Oregon Department of Transportation and the Oregon Department of Land Conservation and Development. This TGM grant is financed, in part, by federal Safe, Accountable, Flexible, Efficient Transportation Equity Act: A Legacy for Users (SAFETEA-LU), local government, and State of Oregon funds.**

**The contents of this document do not necessarily reflect views or policies of the State of Oregon.**

**Financial assistance was provided in part for development of this Newport Pedestrian and Bicycle Plan by the Coastal Zone Management Act of 1972, as amended, administered by the Office of Ocean and Coastal Resource Management, National Oceanic and Atmospheric Administration, through a grant to the Department of Land Conservation and Development.**

# **ADOPTION BY CITY OF NEWPORT** **ORDINANCE NO. 1963**

**The City of Newport adopted the July 2008 Newport Pedestrian and Bicycle Plan by Ordinance No. 1963 on August 18, 2008, as part of the City of Newport Transportation System Plan (TSP) Update (Newport File No. 2-CP-08). The Newport Pedestrian and Bicycle Plan was Exhibit “F” of Ordinance No. 1963. Please be aware that this version of the July 2008 Newport Pedestrian and Bicycle Plan may contain different formatting or pagination than the original version adopted as Ordinance No. 1963 Exhibit “F”. Additionally, this version contains several other items including funding acknowledgements, lists of Project Management Team members and TSP Update Ad Hoc Advisory Committee members, and removal of the word “Draft” from several of the header portions of Sections from the adopted Ordinance No. 1963 Exhibit “F” document.**

# Acknowledgements

The City of Newport appreciates the efforts of the numerous residents who participated in the development of this Plan. Their creativity, energy, and commitment to the future of Newport were the driving force behind this planning effort. In addition, the following citizens, City staff, and other agency and organization members contributed regularly to the development of the Pedestrian and Bicycle Plan.

## Project Management Team

City of Newport  
Oregon Department of Transportation  
Oregon Department of Land Conservation and Development

## TSP Update Ad Hoc Advisory Committee

Lon Brusselback  
Mike Larsen  
Patti Eisler  
Sandy Bruster  
Linda Neigebauer  
Wendy Engler  
John Rehfuss  
John Stutesman  
Chuck Forinash  
Peggy Sabanskas  
Lee Ritzman  
James Bassingthwaite  
John deTar  
Bob Cortright  
Darren Romney  
Diane Henkels

## Consultant Team

Alta Planning + Design, Inc.  
Parametrix, Inc



# Table of Contents

Executive Summary .....	v
<b>1. Introduction.....</b>	<b>1-1</b>
Benefits of Walking and Bicycling.....	1-1
Plan Overview .....	1-2
Goals, Policies, and Implementation Strategies .....	1-3
Plan Organization.....	1-5
<b>2. Existing Conditions.....</b>	<b>2-1</b>
Pedestrian Facilities – An Overview.....	2-1
Bicycle Facilities – An Overview .....	2-8
Pedestrian and Bicycle Destinations .....	2-14
Connections with Transit.....	2-15
Connections to Schools .....	2-16
<b>3. Recommended Pedestrian and Bicycle Network .....</b>	<b>3-1</b>
Introduction .....	3-1
Recommended Pedestrian Network.....	3-1
Recommended Bicycle Network.....	3-13
Project Prioritization .....	3-22
Project Costs .....	3-23
US 101 Crossings .....	3-27
Sidewalks.....	3-28
Sidewalks and Bike Lanes .....	3-32
Bicycle Lanes .....	3-32
Shared Roadways / Bicycle Boulevards .....	3-33
Shared-use Paths .....	3-34
<b>4. Recommended Pedestrian and Bicycle Programs.....</b>	<b>4-1</b>
Introduction .....	4-1
Safe Routes to School .....	4-1
Bicycle Parking.....	4-5
Bicycle/Pedestrian Access to Transit.....	4-5
Alternative Transportation Coordinator .....	4-7
Wayfinding/Signing Program .....	4-7
Spot Improvement Program .....	4-7
Becoming a Bicycle Friendly Community .....	4-7
Sidewalk Infill Program .....	4-9
Accommodating People with Disabilities .....	4-10

Education Programs .....	4-13
Encouragement Programs .....	4-14
Enforcement Programs.....	4-16
<b>5. Design Guidelines and Standards.....</b>	<b>5-1</b>
Introduction .....	5-1
Sidewalks.....	5-1
Bicycle Lanes .....	5-4
Shared Roadways/Bicycle Boulevards .....	5-7
Recommended Street Standards .....	5-15
Transition Zones .....	5-20
Intersection Treatments .....	5-20
Signals and Signal Warrants .....	5-23
Crossing Treatments .....	5-26
Pedestrian-Ways.....	5-31
Shared-Use Paths .....	5-31
Internal Circulation Standards.....	5-38
Bicycle Parking.....	5-39
Transit Stops .....	5-44
Maintenance Guidelines .....	5-45
<b>6. Funding Sources.....</b>	<b>6-1</b>
Federal Funding Sources .....	6-1
State Funding Sources .....	6-3
Local Funding Sources .....	6-5
Other Funding Sources .....	6-6

## List of Figures

Figure 3-1.	Existing Conditions, North Bridgehead, Yaquina Bay Bridge .....	3-11
Figure 3-2.	Recommended Improvements, North Bridgehead, Yaquina Bay Bridge.....	3-11
Figure 3-3.	Recommended Bicycle Boulevard Applications by Street .....	3-22
Figure 5-1.	Bicycle-Safe Drainage Grates.....	5-6
Figure 5-2.	Sample Bicycle Boulevard Treatments .....	5-14
Figure 5-3.	Major Roadway with 6' Minimum Planter Strip.....	5-17
Figure 5-4.	Two Lane Road with 4' Minimum Planter Strip .....	5-17
Figure 5-5.	Shared Use Roadway .....	5-17
Figure 5-6.	Proposed "Woonerf" .....	5-18
Figure 5-7.	Aggregate Filter Strip.....	5-19
Figure 5-8.	Grass Filter Strip .....	5-19
Figure 5-9.	Bio-swale .....	5-19
Figure 5-10.	Type 1+ Crossing with Median .....	5-27
Figure 5-11.	Type 2 Crossing Treatment.....	5-28
Figure 5-12.	Pedestrian-Ways (or "Accessways").....	5-31
Figure 5-13.	Shared-Use Paths .....	5-32
Figure 5-14.	Inverted "U" Rack.....	5-40
Figure 5-15.	Ribbon, Spiral, and Freestanding Racks .....	5-41

Figure 5-16.	Cycle-Safe Lockers .....	5-43
--------------	--------------------------	------

## List of Tables

Table 3-1.	Planning Level Cost Estimates for Tier 1, 2, and 3 Projects .....	3-23
Table 3-2.	Planning Level Unit Cost Estimates for Newport Projects .....	3-25
Table 3-3.	Recommended Pedestrian and Bicycle Projects .....	3-27
Table 5-1.	City of Newport Existing and Proposed Street Design Standards .....	5-16
Table 5-2.	Summary of AtGrade Crossing Recommendations .....	5-30
Table 5-3.	Shared-Use Path Design Recommendations .....	5-33
Table 5-4.	Safety Recommendations .....	5-36
Table 5-5.	Bicycle Rack Placement Guidelines .....	5-42
Table 5-6.	Maintenance Guidelines .....	5-45

## List of Maps

Map 2-1.	Existing Pedestrian Facilities in Newport.....	2-3
Map 2-2.	Existing Bicycle Facilities in Newport.....	2-11
Map 3-1.	Proposed Pedestrian System in North Newport.....	3-3
Map 3-2.	Proposed Pedestrian System in Central Newport.....	3-5
Map 3-3.	Proposed Pedestrian System in South Newport.....	3-7
Map 3-4.	Proposed Bicycle System in North Newport.....	3-15
Map 3-5.	Proposed Bicycle System in Central Newport.....	3-17
Map 3-6.	Proposed Bicycle System in South Newport.....	3-19
Map 3-7.	1994 Newport Parks System Master Plan .....	3-37





## EXECUTIVE SUMMARY

Transportation and recreation are critical facets of life in Newport, and necessitate parks and natural areas, play and sports facilities, recreational amenities and programs, public transit services and connections, and on-street and off-street bikeways and walkways. These elements provide benefits to residents across the spectrum of age, economic status, physical ability, neighborhood location, and daily activity. These elements also offer residents, employees, and visitors complete community connectivity and interrelated opportunities for work, play, shopping, and exercise in and between every neighborhood in the city.

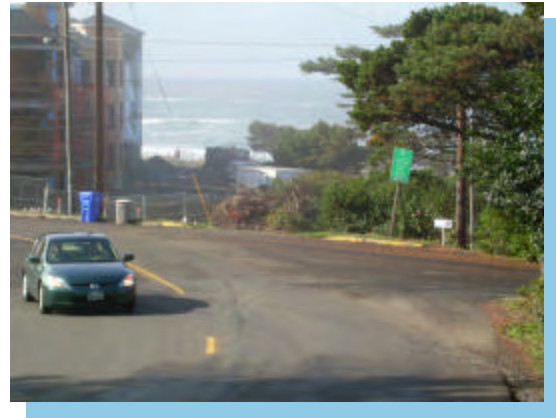

The Pedestrian and Bicycle Plan replaces the bicycle and pedestrian element of the 1997 Newport Transportation System Plan (TSP). The goal of this Plan is to provide a comprehensive list of projects and strategies for system-wide improvements to the walking and bicycling environment.

Sidewalks, bicycle lanes, shoulder bikeways, shared roadways and shared-use paths comprise Newport's existing pedestrian and bicycle network. Obstacles currently facing pedestrian and bicycle travel generally include:

- Maintenance issues
- Lack of well-defined routes
- Fragmented sidewalk network
- Conflicts between pedestrians/cyclists and other transportation users
- Difficult pedestrian/bicyclist crossings at intersections and other locations
- Natural and man-made barriers
- Lack of adequate bicycle parking facilities in some areas
- Difficult pedestrian/bicycle connections to schools and transit

This Plan lays out a comprehensive system of recommended bikeways and walkways connecting key pedestrian and bicycle destinations and surrounding areas. The recommended system was developed based on input from City staff, stakeholder groups and Newport residents. The network also builds upon recommendations from previous planning efforts, including the Newport TSP, the Newport Comprehensive Plan, and the Newport Park System Master Plan. The system includes a variety of facilities including sidewalks, bicycle lanes, shoulder bikeways, an expanded shared roadway/bicycle boulevard network, and shared-use paths.

Equally important to the walkway and bikeway network are support programs. Additional strategies for improving walking and bicycling in Newport include:

- Developing a Safe Routes to School program to encourage children to walk and bicycle to school
- Improving bicycle parking facilities
- Improving pedestrian/bicycle access to transit
- Creating an alternative transportation coordinator position
- Developing a wayfinding/signing program
- Developing a “spot improvement” program for small-scale capital upgrades
- Developing a sidewalk infill program
- Developing education programs (e.g., safety bicycle/pedestrian safety training)
- Developing encouragement programs (e.g., employer incentives, multi-modal access guide, bicycle/pedestrian events)
- Enforcing traffic laws relating to pedestrians and cyclists

A variety of potential sources could help fund Newport’s future pedestrian and bicycle system. Funding could potentially come from Federal sources (including the recently-authorized SAFETEA-LU transportation bill); State sources (including grant programs); and local sources.

# Newport

## Pedestrian & Bicycle Plan



### 1. INTRODUCTION

Newport is located on the beautiful central Oregon Coast, and first built its reputation in the 1860s as a city with world-class oysters. Now in 2007, Newport is celebrating its 125<sup>th</sup> anniversary as a city. Newport is the county seat of Lincoln County.

The City of Newport recognizes that bicycling and walking are an important part of daily transportation for residents, commuters, and other visitors to the city. This Plan is for all residents who desire to bicycle or walk to school or work, improve their level of daily physical activity, or go for a family bicycle ride to the park, aquarium, library, the beach, or downtown.



Yaquina Bay Bridge

### Benefits of Walking and Bicycling

Walking and bicycling are healthy, efficient, low-cost modes of travel, available to nearly everyone. Walking is the most basic form of transportation. Almost everyone is a pedestrian at some point in the day, since walking is often the quickest way to accomplish short trips in urban areas. Pedestrians also include persons using wheelchairs and other forms of mobility devices. Bicycling also provides many community benefits. Bicycling can help reduce traffic congestion, improve air quality, and improve physical fitness. This mode of transportation is also within reach for many people who cannot afford an automobile.

Walking and bicycling help develop and maintain "livable communities," make neighborhoods safer and friendlier, save on motorized transportation costs, and reduce transportation-related environmental impacts, auto emissions, and noise. They create transportation system flexibility by providing alternative mobility options, particularly in combination with transit systems, to people of all ages and abilities. Active living that integrates walking and bicycling into daily activities is key to improving public health and reducing Oregon's obesity crisis. Planners and city leaders are encouraged to create more walkable and bikeable communities that promote healthier lifestyles.

Walking and bicycling are important to the health of all those living and working in Newport, not just to those doing the walking or cycling. People choosing to ride or walk rather than drive are typically replacing short automobile trips, which contribute disproportionately high amounts of pollutant emissions to the environment. Since bicycling and walking contribute no pollution, require no external energy source, and use land efficiently, they effectively move people from one place to another without adverse environmental impacts.

Bicycling and walking require less space and infrastructure compared with automobile facilities. Improvements made for bicyclists often result in better conditions for other transportation users as well. For instance, paved shoulders, wide curb lanes, and bicycle lanes not only provide improved conditions for bicyclists, but also create a safe location for disabled vehicles to stop.

Walking and bicycling are also good choices for families. A bicycle enables a young person to explore her neighborhood, visit places without being driven by her parents, and experience the freedom of personal decision-making. More trips by bicycle and on foot mean fewer trips by car. In turn, this means less traffic congestion around schools and in the community, and less time parents spend driving their children.

Bicycling and walking create opportunities to speak to neighbors and put more "eyes on the street" to discourage crime and violence. Communities with high levels of walking and bicycling often have lower crime rates, and are generally attractive and friendly places to live.

The extent of bicycling and walking in a community has been described as a barometer of how well that community is advancing its citizens' quality of life. Streets that are busy with bicyclists and walkers are working at a human scale, fostering a heightened sense of neighborhood and community.

## Plan Overview

The Pedestrian and Bicycle Plan replaces the bicycle and pedestrian element of the 1997 Newport Transportation System Plan (TSP). The goal of this Plan is to provide an assessment of Newport's existing walking and bicycling environment, and a comprehensive list of projects and strategies for system-wide improvements. This plan incorporates most of the projects proposed by the TSP, in addition to other projects and programs to further enhance bicycling and walking in Newport.



---

## Goals, Policies, and Implementation Strategies

The goal sets forth the long-range vision of what the Pedestrian and Bicycle Plan is trying to achieve. Policies demonstrate what the City of Newport will do to reach the goal, while implementation strategies identify specific measures that need to be taken in order to implement the policies. The intent in the adoption of the Pedestrian and Bicycle Plan is that the policies and implementation strategies are not intended to apply directly to land use actions and permits, but are intended to set the framework for future ordinance amendments as applicable.

### Goal

To promote non-motorized travel and provide a safe interconnected system of pedestrian and bicycle facilities in Newport.

### Policies

The City of Newport shall:

1. Continue to improve, expand, and maintain pedestrian and bicycle facilities, as needed, throughout the community.
2. Ensure that pedestrian and bicycle networks provide direct connections between major activity centers (e.g., downtown Newport, the beach, area schools), and minimize conflicts with other transportation modes.
3. Adopt ordinances requiring sidewalks for all new and infill construction within the city.
4. Regard facilities for pedestrians and bicyclists as important parts of the overall transportation system and not just recreational facilities.
5. Increase the bicycle and pedestrian mode share throughout the City and improve bicycle and pedestrian access to the City's transportation system.

### Implementation Strategies

1. Determine the actual location, design, and routing of pedestrian and bicycle facilities with user safety, convenience, and security as primary considerations.
2. Schedule and coordinate all pedestrian and bicycle improvements with the City's on-going Capital Improvement Program.
3. Establish pedestrian and bicycle construction standards and incorporate into the City's Public Works Standards.
4. Require bicycle lanes on all new Arterial and Major Collector streets, and identify opportunities to provide bicycle lanes on Minor Collectors and other streets as necessary.
5. Provide sidewalks on both sides of all streets with appropriate buffering (e.g. planter strips) wherever possible as part of new roadway construction, roadway reconstruction, and development of other projects affecting City right-of-way.



6. Establish a Sidewalk Infill Program to identify sidewalk gaps, and develop strategies, project prioritization criteria and funding for completing these gaps.
7. Retrofit existing pedestrian and bicycle facilities to current standards (where possible) to promote safety, connectivity, and consistency as funds become available.
8. Require that all walkways and bikeways be constructed in a manner that addresses environmental conditions, such as natural, cultural, and historical features.
9. Discourage the use of cul-de-sac street designs that lack pedestrian and bicycle connectivity.
10. Require pedestrian and bicycle connections within and between developments to provide convenience and safety for pedestrians and bicyclists.
11. Require development of secondary walkways and bikeways internal to individual developments, consistent with the Oregon Transportation Planning Rule.
12. Develop an Americans with Disabilities Act (ADA) Transition Plan to identify strategies and priorities for upgrading the City's current public transportation infrastructure to accommodate persons with disabilities.
13. Establish a routine maintenance schedule for pedestrian and bicycle facilities, including bikeway sweeping and cracked sidewalk repair.
14. Develop and fund a "Spot Improvement" Program to respond quickly to location-specific bicycle/pedestrian infrastructure improvement needs.
15. Coordinate with the Lincoln County School District and the State of Oregon to develop a Safe Routes to School Program to promote walking and bicycling as viable travel modes to school.
16. Develop a safe, secure and convenient network of short- and long-term public bicycle parking facilities.
17. Develop seamless pedestrian/bicycle connections to the Lincoln County Transit system through improved crossings, connections, and transit stop conditions.
18. Develop education programs to increase the awareness of pedestrian and bicyclist needs and rights.
19. Develop encouragement programs to promote walking and bicycling as convenient, healthy, safe and viable transportation modes.
20. Develop enforcement programs to ensure pedestrians, bicyclists, and motorists obey traffic laws.
21. Identify and apply for all available state and federal grant funding opportunities to fund the system improvements identified in the Pedestrian and Bicycle Plan.



## Plan Organization

The Plan begins with a description and assessment of Newport's existing pedestrian and bicycle facilities (Section 2). Based on the assessment, a recommended pedestrian and bicycle network is presented in Section 3, including a detailed list of proposed projects. Along with a recommended network of facilities, the Plan discusses recommended pedestrian and bicycle programs (Section 4) highlighting other methods for addressing walkers' and bicyclists' needs. The design guidelines and standards section (5) expands on the facility types recommended for Newport and also provides additional information on roadway crossings, and signing and striping facilities for bicyclists and pedestrians. Finally, Section 6 identifies potential strategies for funding the recommended pedestrian and bicycle projects and programs.







# Newport

---

## Pedestrian & Bicycle Plan



## 2. EXISTING CONDITIONS

### Pedestrian Facilities – An Overview

The Oregon Bicycle and Pedestrian Plan defines pedestrian facilities as any facilities utilized by a pedestrian. Pedestrian travel is accommodated and enhanced by walkways, traffic signals, crosswalks, curb ramps, and other features like illumination or benches. Newport has several different types of “walkways”, which are defined in the Oregon Bicycle and Pedestrian Plan as “transportation facilities built for use by pedestrians and persons in wheelchairs.” Walkways include the following facilities:

- **Sidewalks:** The most common type of walkway, sidewalks generally parallel roadways. Sidewalks have a hard, smooth surface (e.g., concrete), with separation from the roadway typically consisting of a curb and/or planter strip.
- **Shared-use Paths:** Shared-use paths are used by various non-motorized users, including pedestrians, cyclists, in-skaters, and runners. Shared-use paths are typically paved (asphalt or concrete) but may also consist of an unpaved smooth surface as long as it meets Americans with Disabilities Act (ADA) standards.
- **Roadway Shoulders:** Roadway shoulders often serve as pedestrian routes in rural Oregon communities. On roadways with low traffic volumes (e.g., less than 3,000 Average Daily Traffic (ADT) volumes), roadway shoulders are often adequate for pedestrian travel. Similar to “shoulder bikeways” (described later), these roadways should have shoulders wide enough to accommodate both pedestrians and bicyclists.

### Existing Pedestrian Facilities

The Existing Pedestrian Facilities Map (Map 2-1) on the following page depicts Newport’s current pedestrian network. Sidewalks comprise the vast majority of existing walkways within the city.

*This page intentionally left blank*



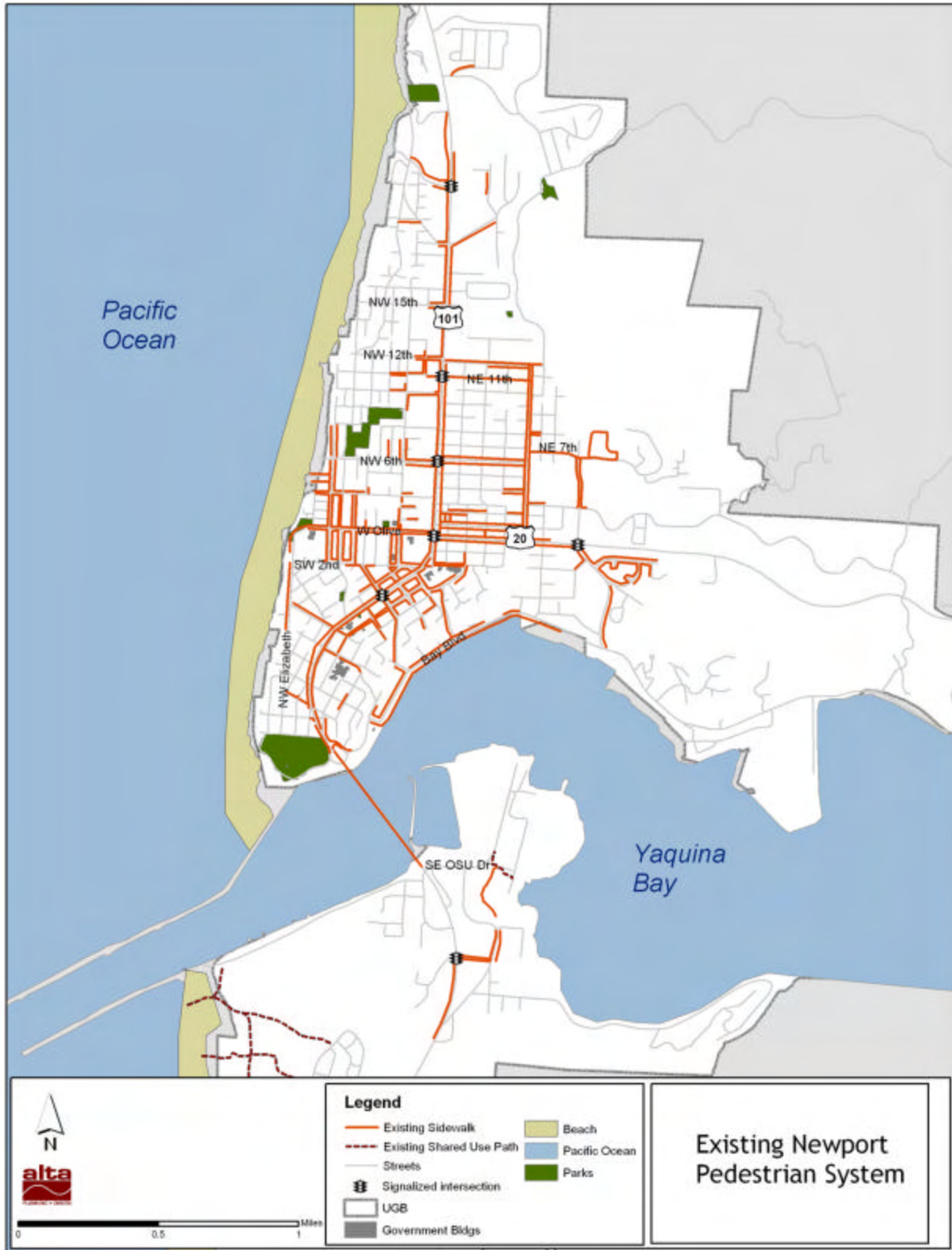

Map 2-1. Existing Pedestrian Facilities in Newport



*This page intentionally left blank*



## Sidewalks

Newport currently has an incomplete sidewalk network, with only certain areas, notably downtown, the US 101 corridor, and the Bay Front having a more comprehensive sidewalk system. Sidewalks also exist along certain east-west corridors, including portions of NE 11<sup>th</sup> and 12<sup>th</sup> Street, NE 6<sup>th</sup> Street, NE 1<sup>st</sup> Street, and W Olive Street. Curb-tight sidewalks exist on the city's Principal Arterial streets (on both sides), including most segments of U.S. 101, with widths ranging from five feet to over eight feet along US 101 and in portions of downtown Newport. Within the city's older residential neighborhoods and in the outlying areas, many streets either have sidewalks on one side only, or lack sidewalks altogether.

Portions of Newport are very pedestrian friendly. The Nye Beach District, the newer segments of US 101, and the area immediately around City Hall have eight to 10 feet wide sidewalks in excellent condition with a variety of complimentary pedestrian facilities, including textured crosswalks, bulb outs, ADA accessible curb ramps, pedestrian-scale lighting, and sidewalk amenities like benches and trash receptacles. However, even in Nye Beach, some of the amenities are located where they interfere with pedestrian movement, especially for visually impaired pedestrians.

In addition to a list of specific sidewalk projects, the Newport TSP proposes strategies for improving the city's sidewalk environment, including:

- Constructing sidewalks on arterials and collector streets where they currently do not exist
- Providing continuous sidewalks on downtown streets and in the beach and bay front areas of town
- Replacing broken sidewalks

The quality of intersections from a pedestrian perspective varies by location. Marked crosswalks and curb ramps exist at most major intersections on Arterial streets and within downtown Newport. The signalized intersections include pedestrian-activated signals or have pre-timed signal phasing allowing pedestrian crossing movements concurrent with parallel vehicle movements. Conditions along Collector and Local streets also vary by location. Marked crosswalks exist at intersections near schools and other pedestrian generators. Many sidewalks along collectors have old curb ramps that are not in compliance with



Sidewalk on U.S. 101 near 15th Street



Wide sidewalks with curb ramps and bulb-outs in Nye Beach area



Sidewalk fire hydrant on ramp, preventing full use of the curb ramp on SW 2nd Street



new ADA standards and guidelines. Other curbs lack ramps entirely. When present, common deficiencies include ramps of insufficient width (less than 36 inches), ramps that are not aligned with the pedestrian flow, excessive slope (maximum of 1:12), excessive cross-slope (maximum of 1:50), no detectable warnings on walking surfaces, inadequate landings, and obstacles in the pedestrian path.

### **Shared-Use Paths/Trails**

Newport currently has several shared-use paths, however they are mostly internal pathway systems, such as those found in Sam Moore Parkway and South Beach State Park. A shared-use path encircles the OSU Hatfield Marine Science Center, connecting the Aquarium with the Bay front. The TSP identifies a potential pedestrian trail along the North Jetty access road to the west of the Coast Guard Station.

### **General System Deficiencies**

Pedestrians face daily obstacles in Newport, as described below.

#### **Maintenance Issues**

Existing sidewalks in many parts of Newport suffer from cracking or heaving. Additionally, overgrown vegetation obstructs the sidewalk in some places, forcing pedestrians to walk in the adjacent planter strip (where one exists) or in the road.



Sidewalk with overgrown vegetation near Nye Beach

#### **Lack of Transit Stop Amenities**

Many of the designated stops along the Lincoln County bus and Newport summer shuttle routes lack basic passenger amenities such as shelters, benches, and posted schedules. Walkways providing access to some stops are also in substandard condition.

#### **Topography**

Newport is located on a plateau with steep hills heading down to both the Bay Front and Historic Nye Beach and the oceanfront, making it difficult for many pedestrians to reach desirable destinations or to walk confidently from one destination to another.

#### **Lack of Signage**

Newport's pedestrian system would benefit from signage and other wayfinding tools to orient pedestrians and direct them to and through major destinations like downtown, Historic Nye Beach, and the Bay Front. This has been a recent goal of the Pedestrian and Bicycle Committee.



### Fragmented Sidewalk Network

Although a relatively complete sidewalk network exists in certain portions of Newport (such as Nye Beach, and the Bay Front), the system is fragmented in other areas. Several streets (e.g. NE 12<sup>th</sup> Street, NE 7<sup>th</sup> Street) near pedestrian destinations like Yaquina View Elementary, Sam Case Elementary, Newport Middle and High schools, Newport Hospital, Yaquina Bay State Park, and Sam Moore Parkway, have sidewalks on one side or no sidewalks at all. Neighborhoods at both the city's northern and southern edges also have a fragmented sidewalk network. (See Map 2-1)



Demand path across from the library

### Difficult Crossings

Pedestrians face a variety of difficult street crossing conditions:

- Crossing US 101 and US 20 is challenging due to relatively long distances between signalized intersections and marked crossings. This discourages pedestrians from walking to services along those roadways. Many chose to dart across the roadway to reach their desired destinations.
- In several locations, crosswalks are difficult to see for approaching motorists. Crosswalk bars on many of the City's longitudinal (also known as "ladder style") crosswalks are fairly narrow and spaced far apart.
- Pedestrians with disabilities experience crossing difficulties in Newport. Curb ramps at many intersections are in poor condition or disrepair, while some intersections lack curb ramps altogether. This can make traveling by wheelchair or motorized mobility device challenging, if not impossible. Visually and mobility impaired pedestrians experience difficulty navigating through intersections with curb ramps oriented diagonally toward the intersection's center rather than toward a crosswalk. Signalized intersections also lack audible pedestrian signals to facilitate safe crossings for the visually impaired.



Bicyclist attempting to cross U.S. 101 at 15th Street



Some crosswalks are difficult to see due to minimal markings



## Bicycle Facilities – An Overview

According to AASHTO's Guide for the Development of Bicycle Facilities (1999) and the Oregon Bicycle and Pedestrian Plan, there are several types of "bikeways". Bikeways are distinguished as preferential roadways accommodating bicycle travel. Accommodation can take the form of bicycle route designation or bicycle lane striping. Shared-use paths are separated from a roadway for use by cyclists, pedestrians, in-line skaters, runners, and others.

The Existing Bicycle Facilities Map (Map 2-2) depicts Newport's existing bicycle network. Existing facilities include bicycle lanes, shoulder bikeways, and shared-use paths in some areas, although shared roadways constitute the majority of existing bikeways in the City.



Yaquina Bay Bridge sidewalk with truck traffic

### Bicycle Lanes

Designated exclusively for bicycle travel, bicycle lanes are separated from vehicle travel lanes with striping and also include pavement stencils. Bicycle lanes are most appropriate on arterial and collector streets where higher traffic volumes and speeds warrant greater separation. Bicycle lanes currently exist on several streets:

- NE Harney Street (NE 3<sup>rd</sup> St to NE 7<sup>th</sup> St)
- US 101 (south direction only)(Agate Beach Wayside Access Rd to NW 25<sup>th</sup> St)
- US 101 (NW 49<sup>th</sup> St to NW 54<sup>th</sup> St)

The bicycle lanes in Newport are approximately 5' wide, reflecting the City's minimum standard.

### Shoulder Bikeway

Typically found in rural areas, shoulder bikeways are paved roadways with striped shoulders wide enough for bicycle travel. Shoulder bikeways often include signage alerting motorists to expect bicycle travel along the roadway.

A shoulder bikeway exists on U.S. 101 north of NW 25<sup>th</sup> St (except where bike lanes are striped) and on US 101 south of the Yaquina Bay Bridge, with shoulder widths ranging from four to seven feet.

### Shared Roadway

The most common type of bikeway, shared roadways accommodate vehicles and bicycles in the same travel lane. The most suitable roadways for shared vehicle/bicycle use are those with low posted speeds (25 MPH or less) or low traffic volumes (3,000 ADT or less). These facilities may include traffic-calming devices to reduce vehicle speeds while limiting conflicts between motorists and bicyclists. Most of Newport's minor collector and local streets can be classified as shared roadways, as they can accommodate bicyclists of all ages and currently have little need for dedicated bicycle facilities (e.g.,





bicycle lanes). Curb-to-curb widths generally range between 40' and 50' and the typical street cross-section includes two vehicle travel lanes with on-street parking.

### **Bicycle Route**

A common practice includes signing shared roadways with bicycle route signs, directional arrows and other wayfinding information. Signed bicycle routes currently exist on several streets:

- US 101 / Oceanview Drive / SW Elizabeth Street (The Oregon Coast Bicycle Route)
- NE 11<sup>th</sup> Street
- NE 1<sup>st</sup> Street
- NE Eads Street
- SE Fogarty Street

### **Shared-Use Paths**

Described earlier, shared-use paths are used by various non-motorized users, including pedestrians, cyclists, in-skaters, and runners. Shared-use paths are typically paved (asphalt or concrete) but may also consist of an unpaved smooth surface as long as it meets ADA standards.

Newport currently has several shared-use paths, however they are mostly internal pathway systems, such as those found in Sam Moore Parkway and South Beach State Park. A shared-use path encircles the OSU Hatfield Marine Science Center, connecting the Aquarium with the Bay front. The TSP identifies a potential pedestrian trail along the North Jetty access road to the west of the Coast Guard Station.



*This page intentionally left blank*





Map 2-2. Existing Bicycle Facilities in Newport



*This page intentionally left blank*



## Bicycle Parking

The provision of bicycle parking is an important component in planning bicycle facilities and encouraging widespread use. Minimum recommended bicycle parking requirements for various land uses are established in Table 8 in Chapter II.3 of the Oregon Bicycle and Pedestrian Plan.

In completing field work and in discussions with the public, there is a general perception that not enough bicycle parking is provided (especially covered bike parking), particularly in desirable locations such as Nye Beach, the Bay Front, and near government buildings in downtown Newport. The shortage of quality bicycle racks in high-demand locations typically generates informal bicycle parking activities with cyclists securing their bikes to hand rails, street signs, light poles and other objects.



Accessible bicycle parking at the Oregon Coast Aquarium

## General System Deficiencies

Bicyclists face several various issues, including:

### Maintenance Issues

Gravel, glass and other debris are routinely present on the bikeway system. This typically occurs when passing motor vehicles blow debris into the adjacent bicycle lane or shoulder.

### Poor Pavement Conditions

Several on-street bikeways are characterized by poor pavement conditions, including potholes and uneven surfaces.

### Lack of Signage

Newport's bikeway system lacks signage and other wayfinding tools to orient riders and direct them to and through major bicycling destinations like downtown and the Bay Front.

### Conflicts Between Cyclists and Other Transportation Users

Cyclist safety and comfort issues arise on higher volume roadways lacking dedicated bicycle facilities or traffic-calming treatments. For example, NW Nye Street provides a parallel north-south bicycle route to US 101, providing connections to residential areas, the library, parks, and downtown. However, the street also serves as a local vehicle circulation route with increasing traffic volumes, creating an uncomfortable bicycling environment.



Older signage on bike route obscured by vegetation



Debris in the bikeway on U.S. 101



## Topography

Newport is located on a plateau with steep hills heading down to both the Bay Front and Nye Beach and the oceanfront, making it difficult for many bicyclists to comfortably make round trips to these destinations, or to travel confidently from one destination to another.

## Barriers

Yaquina Bay is a natural barrier that divides the city and destinations such as the Hatfield Marine Science Center and the Oregon Coast Aquarium from the major residential areas. The Yaquina Bay Bridge has a 3'5" wide sidewalk with two 11-foot wide travel lanes. A signal button that activates a flashing yellow light above a "Bikes on Bridge When Flashing" sign is provided for cyclists wishing to ride across the bridge. Otherwise, cyclists are asked to walk their bikes on the sidewalk across the ~ 0.5-mile bridge. Riding on the sidewalk is not recommended due to high winds that may suddenly blow cyclists from the sidewalk into the travel lanes.

## Lack of Shared Roadway Treatments

Although the Newport TSP proposes a designated shared roadway network, the Plan does not prescribe any treatments (e.g., signage, pavement markings, traffic calming) to facilitate safe, comfortable and convenient bicycle travel. The existing signed bicycle routes do not adequately illustrate the best connections, leaving bicyclists to work out the best routes for themselves.

## Cyclist Behavior

A number of local bicyclists were observed riding on sidewalks and against traffic. This may indicate the need for education about safe bicycling techniques.

## **Pedestrian and Bicycle Destinations**

US 101 and US 20 provide regional bicycle connections to other highways and county roads and to other communities like Siletz, Depoe Bay, Toledo, Lincoln City, and Waldport.

Within Newport, popular pedestrian/bicycle destinations include:

- Bay Front
- US Post Office
- Newport Public Library



Cyclists must either use vehicle travel lanes or gravel shoulders on NE Harney near U.S. 20



Existing signage for crossing Yaquina Bay Bridge



- Historic Nye Beach
- Yaquina View Elementary School, Sam Case Elementary School, Newport Middle and High schools
- Yaquina Bay State Park
- Burrows House Museum
- Newport Performing Arts Center
- Newport Senior Center
- Services along US 101

## Connections with Transit

Ensuring a strong pedestrian and bicycle link to transit is an important part of making non-motorized transportation a part of daily life in Newport. There are four main components of bicycle/pedestrian-transit integration:

- Allowing bicycles on transit
- Providing benches, shelters, posted schedules, bicycle parking and other features at transit stops
- Improving connections between walkways, bikeways and transit
- Encouraging use of bicycle and transit programs

Lincoln County Transit, Newport's main transit provider, provides fixed route bus service linking Newport with Yachats, Siletz/Toledo, and Lincoln City. All buses are ADA-accessible and come equipped with two capacity bike racks, however bikes are not allowed inside buses. The City of Newport also operates a free summer shuttle linking major business areas and tourist attractions in the city.

The quantity and quality of pedestrian infrastructure along the bus and shuttle routes varies by location. Most streets along the routes have sidewalks on both sides, including US 101, NE Avery Street, W Olive Street, SW Bay Blvd, and SW Coast Street. Several streets however lack sidewalks on one or both sides, including NE 4<sup>th</sup> Street, SW Fall Street, SW Elizabeth Street, and SW Bayley Street. It should be noted that sidewalks on several streets listed above are in substandard condition (e.g., cracked or in disrepair). Substandard sidewalks or the lack of sidewalks decreases



The Newport public library is a desirable destination for many residents.



Shuttle sign posted on saw horse to serve as shuttle bus stop



The sidewalk has a number of power poles that occupy much of the pedestrian space near the high school.



accessibility for all users, especially during the winter months when inclement weather is expected. Most designated stops lack passenger amenities like shelters, benches, posted schedules and bicycle parking. This also decreases the value of transit as a viable transportation option.

## Connections to Schools

### **Sam Case Elementary School, Newport Middle School, Newport High School, Central Coast SDA School**

Three of Newport's four public schools are concentrated in northeast Newport, east of US 101 and north of US 20. The Central Coast SDA School is also nearby. With the exception of existing bicycle lanes on portions of NE Harney Street near Newport Middle School, all streets in this area lack dedicated bicycle facilities. Predominantly residential in character, most streets handle relatively low traffic volumes and are suitable for bicycle travel.

The sidewalk network is fragmented near Sam Case Elementary, Central Coast SDA School, and Newport Middle and High schools. Within the immediate vicinity, streets lacking sidewalks on both sides include NE Benton Street, NE Avery Street, and NE Douglas Street, in addition to nearly all east-west streets between NE 1<sup>st</sup> Street and NE 12<sup>th</sup> Street. Other streets, including NE 11<sup>th</sup> Street, NE 7<sup>th</sup> Street east of NE Harney Street, and NE 12<sup>th</sup> Street have sidewalks on one side only. The only streets with completed sidewalks on both sides of the street in the vicinity of the schools are NE 6<sup>th</sup> Street, NE 1<sup>st</sup> Street, and NE Eads Street. The TSP includes several proposed projects to complete sidewalk gaps in this area. Marked crosswalks exist along NE Eads Street and NE 6<sup>th</sup> Street leading to the schools. Curb ramps in varying conditions exist at some intersections where sidewalks are provided. In some locations however, curb ramps and marked crosswalks do not align with each other.





### **Yaquina View Elementary School, Sonshine Christian School**

Yaquina View Elementary School and the Sonshine Christian School are located south of US 20. Streets in the immediate vicinity lack dedicated bicycle facilities, including both US 20 and SE Moore Drive, two streets with higher traffic volumes that are not amenable to bicycle travel for younger bicyclists. The few remaining streets in the vicinity have relatively low vehicle traffic volumes and are suitable for bicycle travel.

No street in the immediate vicinity has complete sidewalks on both sides of the street. Both US 20 and SE Moore Drive have the most complete sidewalks, although streets have sections where sidewalk is missing. SE 2<sup>nd</sup> Street also has sidewalks in segments, although not adjacent to Yaquina View Elementary School. The remaining streets in the immediate vicinity lack sidewalks. . In addition, the lack of street connectivity in this area of Newport reduces the available routes to school for students and forces them onto US 20 or down to SE Bay Blvd to reach school.





# Newport

---

## Pedestrian & Bicycle Plan

### 3. RECOMMENDED PEDESTRIAN AND BICYCLE NETWORK

#### Introduction

This chapter lays out the recommended pedestrian and bicycle network, a comprehensive system of bikeways and walkways connecting key pedestrian and bicycle destinations and surrounding areas. City staff, stakeholder groups, consultants and Newport residents all worked together to develop this recommended system. The network also builds upon current and past planning efforts, most notably the 1997 Newport TSP.

The following maps and text depict and discuss the recommended walkway and bikeway network. A list provided at the end of this chapter outlines individual project proposals.

#### Recommended Pedestrian Network

The Proposed Pedestrian System Maps (Map 3-1 through Map 3-3) on the following pages depicts existing and proposed pedestrian facilities. Proposed improvements include filling major gaps in the existing sidewalk system and providing sidewalks on new streets. Other pedestrian system recommendations include shared-use paths and US 101 crossing improvements to accommodate safe and convenient pedestrian crossings.

#### Sidewalks

The projects depicted on the Proposed Pedestrian System Map (and listed in the project table at the end of this chapter) build upon recommendations of the TSP, and reflect input received from City staff and Newport residents. The City has established guidelines that require sidewalks to be built on both sides of new streets in most cases. To complete the sidewalk network along existing streets, special emphasis should be given to completing sidewalk gaps and providing sidewalks on routes serving major pedestrian destinations (e.g., schools and commercial/tourist points of interest).

*This page intentionally left blank*



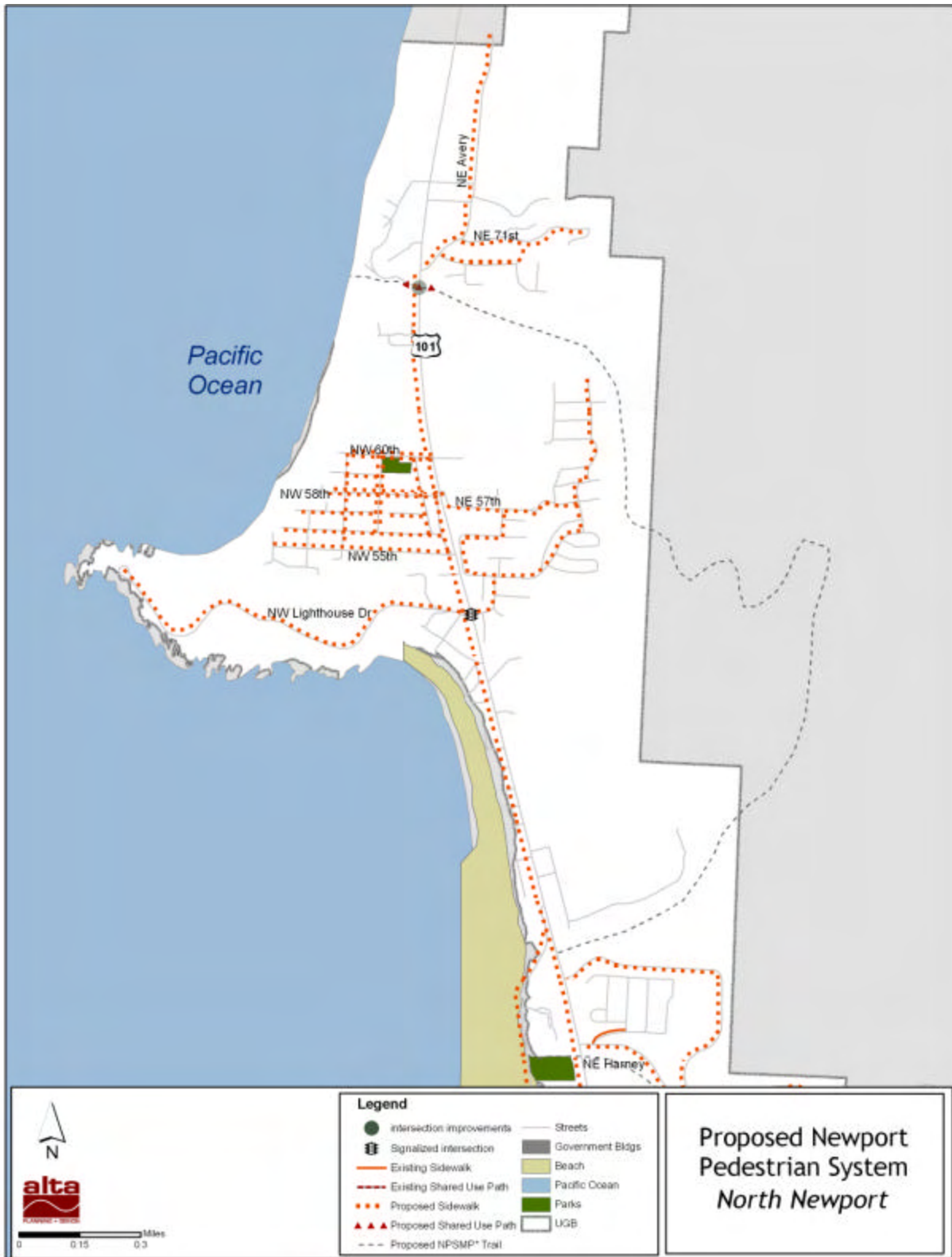

**Map 3-1. Proposed Pedestrian System in North Newport**

\* NPSMP (1994 Newport Park System Master Plan) – See NPSMP Facility Map on page 3-37 for proposed trail locations outside of map boundary



*This page intentionally left blank*





**Map 3-2. Proposed Pedestrian System in Central Newport**

\* NPSMP (1994 Newport Park System Master Plan) – See NPSMP Facility Map on page 3-37 for proposed trail locations outside of map boundary



*This page intentionally left blank*





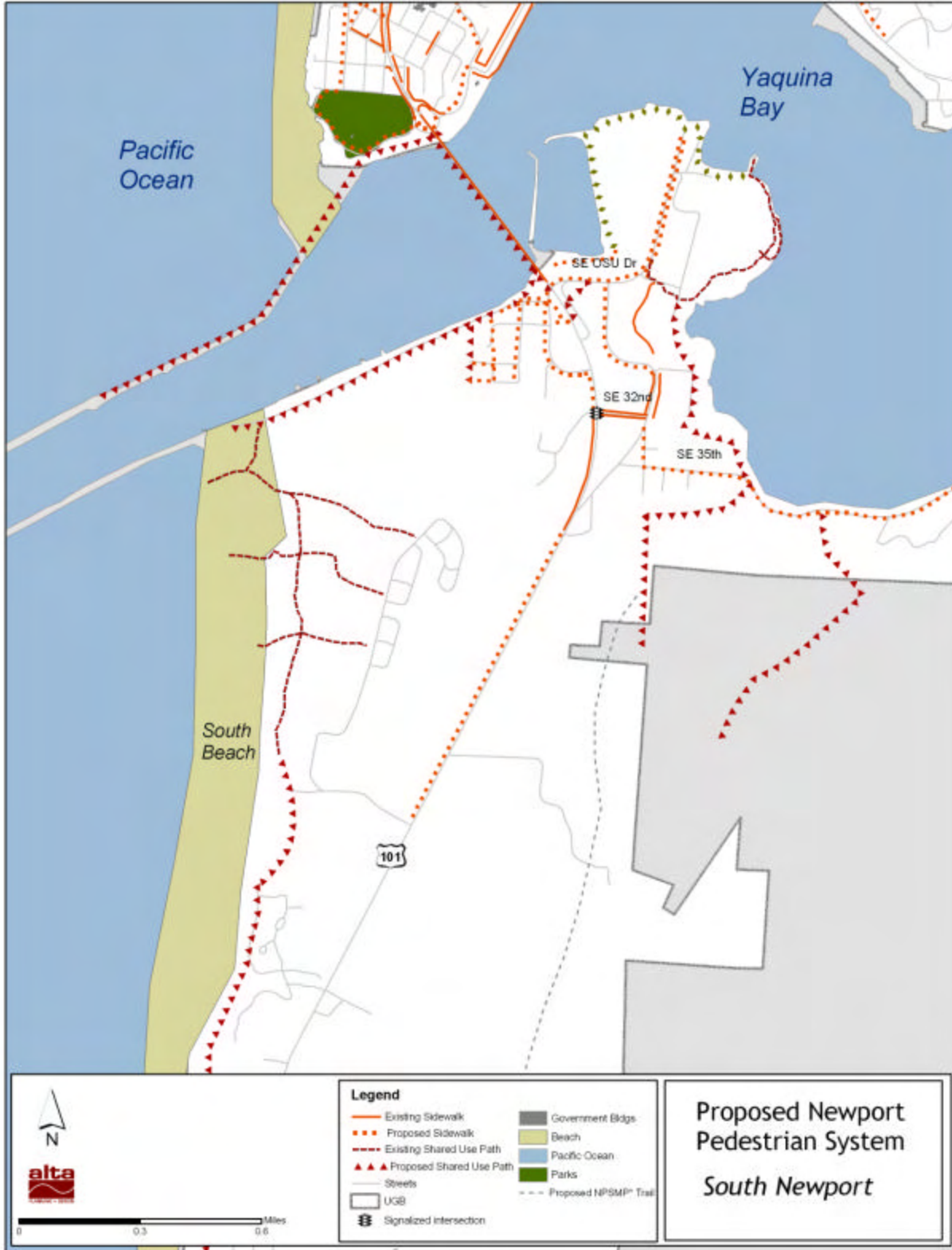

**Map 3-3. Proposed Pedestrian System in South Newport**

\* NPSMP (1994 Newport Park System Master Plan) – See NPSMP Facility Map on page 3-37 for proposed trail locations outside of map boundary



*This page intentionally left blank*



## Intersection Improvements

Pedestrian crossings at intersections represent a major challenge in Newport's existing pedestrian environment. This plan contains an overall strategy to improve intersections and other pedestrian crossings citywide through a variety of treatments (outlined in Section 5, Design Guidelines). Although many intersections throughout Newport could be targeted for enhancements, City staff, ODOT staff, and residents identified the locations discussed below as deserving additional attention in determining how best to ensure bicyclist and pedestrian safety while crossing.

### US 101 Crossings

The crossing locations of US 101 identified for improvement are discussed below (locations identified on Map 3-2):

#### **NW 68<sup>th</sup> undercrossing of US 101**

This crossing location is identified in the Newport Parks System Master Plan as a needed crossing of US 101 in the northern portion of Newport. Undercrossings are discussed further in Section 5 of this plan.

#### **Mid-block between 16<sup>th</sup> Street and 17<sup>th</sup> Street**

Provides an additional pedestrian crossing (along with the crossing at 15<sup>th</sup> Street and the proposed crossing at 13<sup>th</sup> Street) between the signals at 11<sup>th</sup> Street and 20<sup>th</sup> Street. The crossing should include a raised median island, advance stop bars in the vehicle lanes, appropriate signage indicating the presence of a pedestrian crossing, and a striped continental crosswalk.

#### **13<sup>th</sup> Street**

It was determined that an additional pedestrian crossing was needed between the signal at 11<sup>th</sup> Street and the existing pedestrian crossing at 15<sup>th</sup> Street. This location near the McDonalds was identified as the most likely desired crossing location. The crossing should include a raised median island, advance stop bars in the vehicle lanes, appropriate signage indicating the presence of a pedestrian crossing, and a striped continental crosswalk.

#### **10<sup>th</sup> Street**

There is an existing pedestrian crossing where NE 10<sup>th</sup> Street intersects US 101, located on the north side of the 'T' intersection. It is recommended that the crossing be moved to the south side of the intersection and improved through the installation of a raised median and the striping of advance stop bars and continental crosswalks.

#### **8<sup>th</sup> Street**

Provides an additional pedestrian crossing between the signal at 6<sup>th</sup> Street and the signal at 11<sup>th</sup> Street. The crossing should be located north of the intersection of NW 8<sup>th</sup> Street and US 101 and include: a raised median island, advance stop bars in the vehicle lanes, appropriate signage indicating the presence of a pedestrian crossing, and a striped continental crosswalk.

#### **3<sup>rd</sup> Street / 4<sup>th</sup> Street**

There is an existing pedestrian crossing located at NW 3<sup>rd</sup> Street. It is recommended that this crosswalk be moved to the south side of the NE 4<sup>th</sup> Street / US 101 intersection (across from the Arctic Circle). This location provides a more direct connection to the high school while also providing the opportunity for a raised median. The improved crossing should also include advance stop bars in the vehicle lanes, appropriate signage indicating the presence of a pedestrian crossing, and a striped continental crosswalk.

#### **2<sup>nd</sup> Street (outside City Hall)**

A crosswalk in this location provides access to the City offices as well as the transit stop located outside of City Hall. The recommended location is just north of the 2<sup>nd</sup> Street access in front of City Hall and just south of the Chevron gas station



driveway. The crossing should include a raised median island, advance stop bars in the vehicle lanes, appropriate signage indicating the presence of a pedestrian crossing, and a striped continental crosswalk.

**SW Angle Street, SW Lee Street, SW Hubert Street (signalized), SW Alder Street**

It is recommended that curb extensions be installed at all intersections along US 101 through downtown Newport where on-street parking is allowed. The curb extensions shorten the crossing distance while making pedestrians more visible to the on-coming vehicle traffic.

**SW Neff Way**

There is an existing marked crosswalk at SW Neff Way on the southern end of the 'T' intersection. This crosswalk passes through a well-used left turn lane from US 101 to SW Neff Way. The recommendation is to move the marked crosswalk to the north side of the intersection. The crossing should include a raised median island, advance stop bars in the vehicle lanes, appropriate signage indicating the presence of a pedestrian crossing, and a striped continental crosswalk.

**SW Abbey Street and SW Bay Street**

New crossings at SW Abbey Street and SW Bay Street provide access to the hospital and further east, the Bay Front from west Newport. These locations are not appropriate for a raised median given the allowed turning movements at both intersections. The recommendation is to tighten the turning radius for vehicles turning onto SW Abbey Street and to SW Bay Street, particularly on the east side of US 101. In addition, marked crosswalks should be provided on both sides of the intersection with the appropriate signage for drivers.

**Mid-block between SW Bayley Street and SW Minnie Street**

A crossing in this location provides access to Yaquina Bay State Park and the regional transit offices. The crossing should include a raised median island, advance stop bars in the vehicle lanes, appropriate signage indicating the presence of a pedestrian crossing, and a striped continental crosswalk. In addition, adding curb extensions to reduce the turning radius of both streets should shorten the crossing distance at both SW Minnie and SW Bayley.

The TSP also recommends a median along portions of US 101, which would greatly improve pedestrian crossings by providing a refuge for pedestrians and allow them to cross US 101 in two stages, increasing their safety while also increasing the number of potential gaps in traffic the pedestrian will be able to take advantage of in crossing only two lanes of traffic, rather than trying to cross 4 or 5 lanes at once.

As noted earlier, additional types of crossing treatments are discussed in more detail in Section 5.



### North Bridgehead

The figures below describe the existing and the recommended improvements for increasing bicyclist and pedestrian safety around the north end of the Yaquina Bay Bridge.

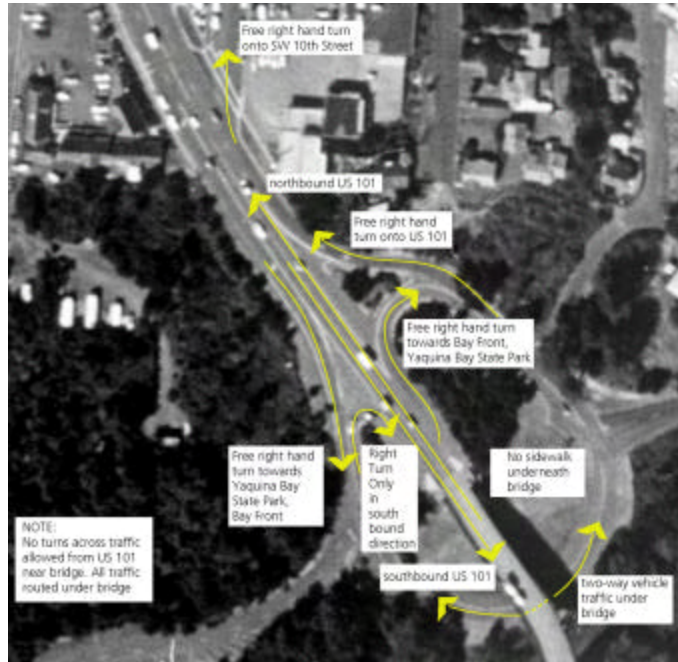

Figure 3-1. Existing Conditions, North Bridgehead, Yaquina Bay Bridge

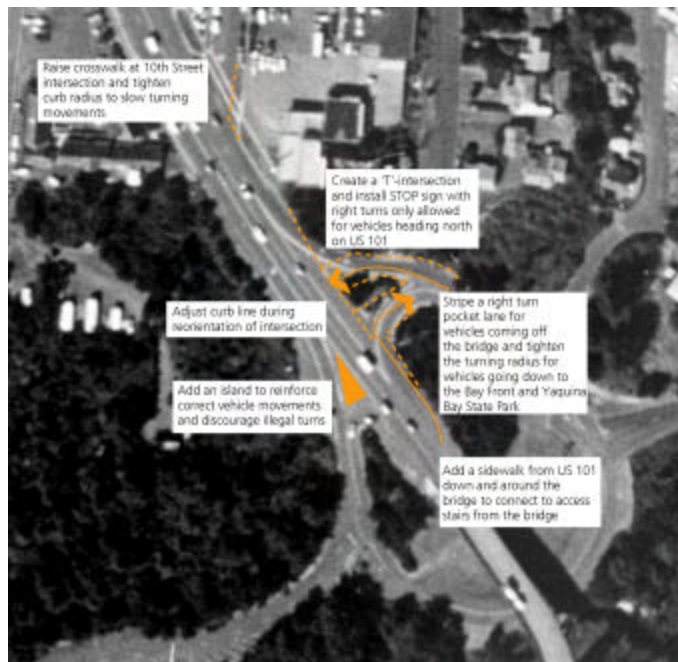

Figure 3-2. Recommended Improvements, North Bridgehead, Yaquina Bay Bridge



## Shared-use Paths

Shared-use paths are proposed in sections of Newport to provide transportation and recreational benefits to residents and visitors. This section briefly discusses these recommendations.

### Big Creek Path

A shared-use path could potentially follow the alignment of the existing NE Big Creek Road. Currently the road is a signed for one-way vehicle traffic. However, the TSP documents plans for the extension of NE Harney Street north from NE 7<sup>th</sup> Street past Frank Wade Park to connect with another existing portion of NE Harney Street. Once this extension is completed, NE Big Creek Road can be converted to a shared-use path for the use of bicyclists, pedestrians, and other non-motorized users. This will provide an excellent north-south alternative to US 101 while providing additional connections to residential areas, the middle and high school, the fair grounds, and parks.

### SW Jetty Path

Providing a shared-use path along the south jetty will provide a connection from the bridge, residential areas, and the Aquarium to the south jetty and connect into the existing path system within South Beach State Park.

### North Jetty Path

The north jetty path would be a shared-use path from SW Naterlin Drive down and along the north jetty. Coordination between the US Coast Guard, Oregon State Parks, US Army Corps of Engineers, and the City of Newport would be required to ensure the safety of all users while preserving access to the north jetty for authorized vehicles.

### Yaquina Bay Bridge

As noted earlier, the Yaquina Bay Bridge does not meet current ODOT standards for bicyclist and pedestrian bridge accommodations. Improved bicycle and pedestrian facilities can be provided in two ways.

- Widen the sidewalks on both sides to a minimum of 10 feet when bridge improvements are undertaken, creating paths on either side of the bridge deck.
- Attach a separated bicycle/pedestrian bridge to the existing Yaquina Bay Bridge. This structure could possibly be attached to the bridge pilings or the bottom of the bridge deck, based on an engineering study. In addition, appropriate access points would have to be identified and designed to both the north and south of the bridge.

### SE 2<sup>nd</sup> Street Bridge

As noted earlier, access to Yaquina View Elementary School is constrained by the lack of street connectivity. To improve connectivity in this area of Newport and provide alternate biking and walking routes to US 20, a non-motorized bridge should be provided to connect SE 2<sup>nd</sup> Street across the ravine.

## Paths in South Newport

Opportunities exist to develop shared-use paths in conjunction with planned residential and commercial development in South Newport. This would enhance the transportation network while providing recreational benefits to the employees and residents of the area. A shared-use path could also be tied into Oregon Coast Community College as the area develops.



## Recommended Bicycle Network

The Proposed Bicycle System Map (Map 3-4 through Map 3-6) depicts existing and proposed bicycle facilities. Proposed facilities include bicycle lanes and shared roadways/bicycle boulevards. The proposed system also includes shared-use paths, described earlier in this chapter. The proposed bicycle system builds upon previous planning efforts, and also addresses input received from City staff, Newport residents, and other stakeholders.

To safely accommodate bicycle travel on corridors with current or anticipated high traffic volumes, bicycle lanes are proposed on several existing and future streets, based on several factors, including:

- Gaps in the existing bicycle lane system
- Existing and forecasted traffic volumes
- Previous planning efforts identifying the need for bicycle lanes on specific streets
- Planned street improvements that will include bicycle lanes as part of construction
- Whether an existing street could be retrofitted to include bicycle lanes with minimal parking or private property impacts
- Planned land development projects with the potential to generate higher bicycle volumes



*This page intentionally left blank*





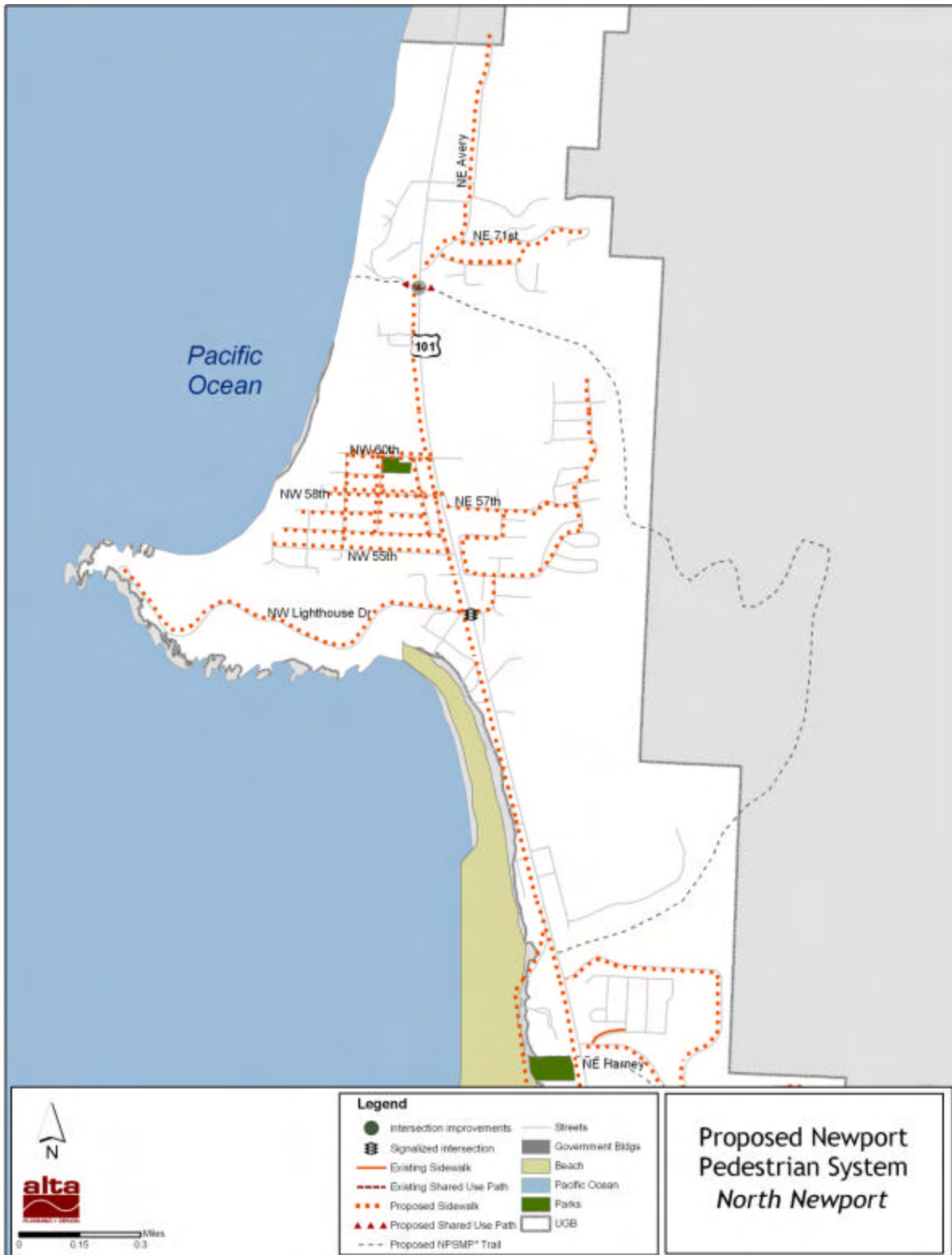

**Map 3-4. Proposed Bicycle System in North Newport**

\* NPSMP (1994 Newport Park System Master Plan) – See NPSMP Facility Map on page 3-37 for proposed trail locations outside of map boundary



*This page intentionally left blank*





**Map 3-5. Proposed Bicycle System in Central Newport**

\* NPSMP (1994 Newport Park System Master Plan) – See NPSMP Facility Map on page 3-37 for proposed trail locations outside of map boundary



*This page intentionally left blank*



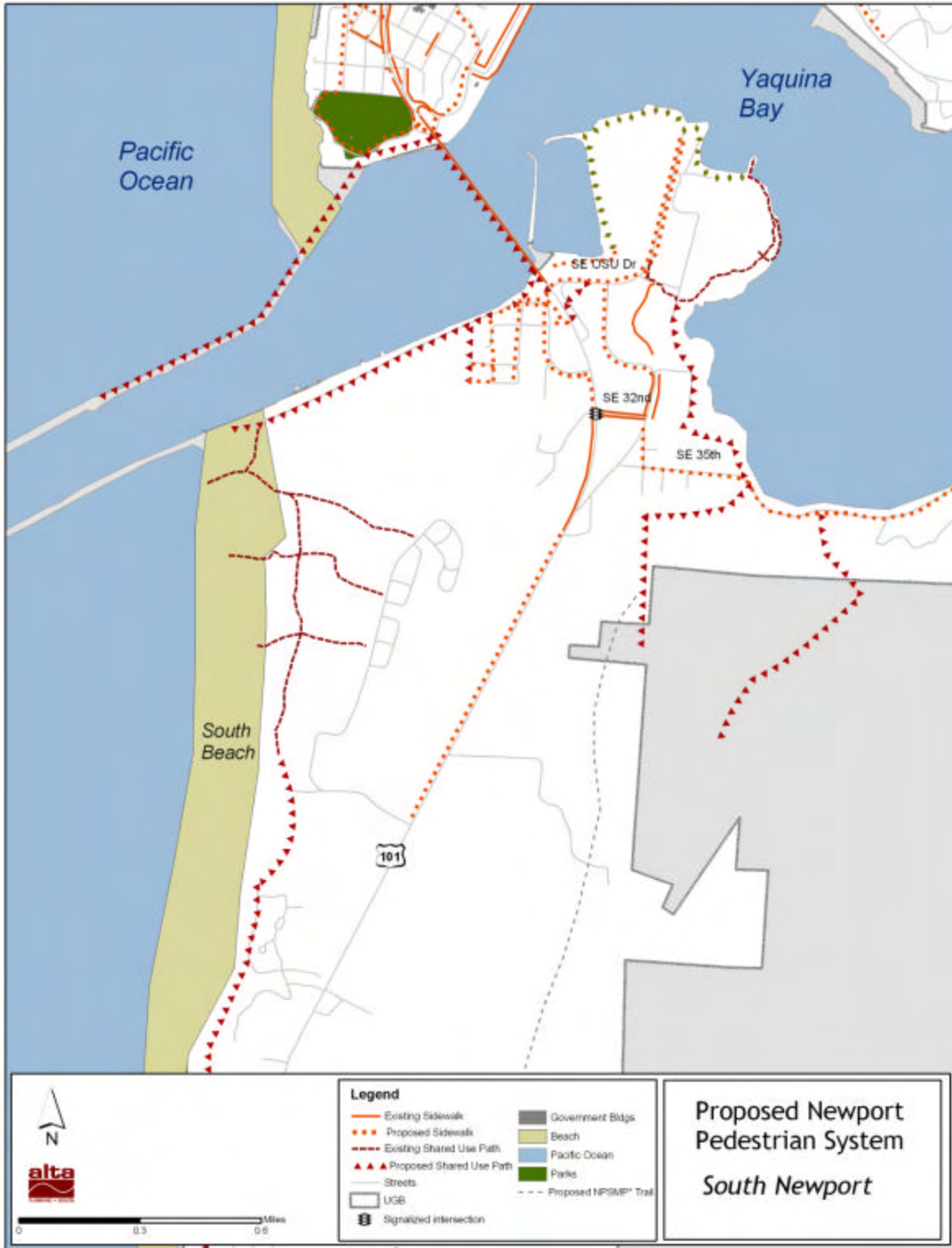

**Map 3-6. Proposed Bicycle System in South Newport**

\* NPSMP (1994 Newport Park System Master Plan) – See NPSMP Facility Map on page 3-37 for proposed trail locations outside of map boundary



*This page intentionally left blank*



## Bicycle Lanes

A variety of physical and other constraints create challenges for retrofitting many existing streets with bicycle lanes in Newport. As a result, most bicycle lanes are proposed on streets with relatively wide rights-of-way and on streets with fewer physical constraints, such as NW Nye Street. The City should continually monitor vehicle and bicycle travel patterns throughout the entire community, and identify opportunities to provide bicycle lanes on higher-volume streets wherever possible.

## Shared Roadways/Bicycle Boulevards

A number of streets are proposed as shared roadways and include various applications that can be used to improve bicyclist safety and comfort on these corridors. These applications can be used on most streets in Newport, including streets where physical or other constraints preclude the use of dedicated bicycle lanes. Shared roadways that incorporate treatments to accommodate cyclists are often called “bicycle boulevards.” Bicycle boulevards are developed through a combination of traffic calming measures and other streetscape treatments, and are intended to prioritize safe and convenient bicycle travel. Appropriate treatments depend on several factors including traffic volumes, vehicle and bicycle circulation patterns, street connectivity, street width, physical constraints, and other parameters.

### Bicycle Boulevard Applications

Treatments for Newport’s shared roadway/bicycle boulevard network have been divided into five main categories based on their level of “intensity”, with Level 1 representing the least intensive treatments that could be implemented at relatively low cost with minimal physical impacts. Described in detail in the Design Guidelines section (Section 5), the five bicycle boulevard application levels include the following:

- Level 1: Signage
- Level 2: Pavement markings
- Level 3: Intersection treatments
- Level 4: Traffic calming
- Level 5: Traffic diversion

Figure 3-1 depicts the recommended application levels for Newport’s shared roadway/bicycle boulevard system. It should be noted that corridors proposed for higher-level applications would also receive relevant lower-level treatments. For instance, a street targeted for Level 3 applications should also include Level 1 and 2 applications as necessary. It should also be noted that some applications may be appropriate on some streets while inappropriate on others. In other words, it may not be appropriate or necessary to implement all “Level 2” applications on a Level 2 street. To identify and develop specific treatments for each bicycle boulevard, the City should involve the bicycling community, neighborhood groups, and the Public Works Department. Further analysis and engineering work may also be necessary to determine the feasibility of some applications.



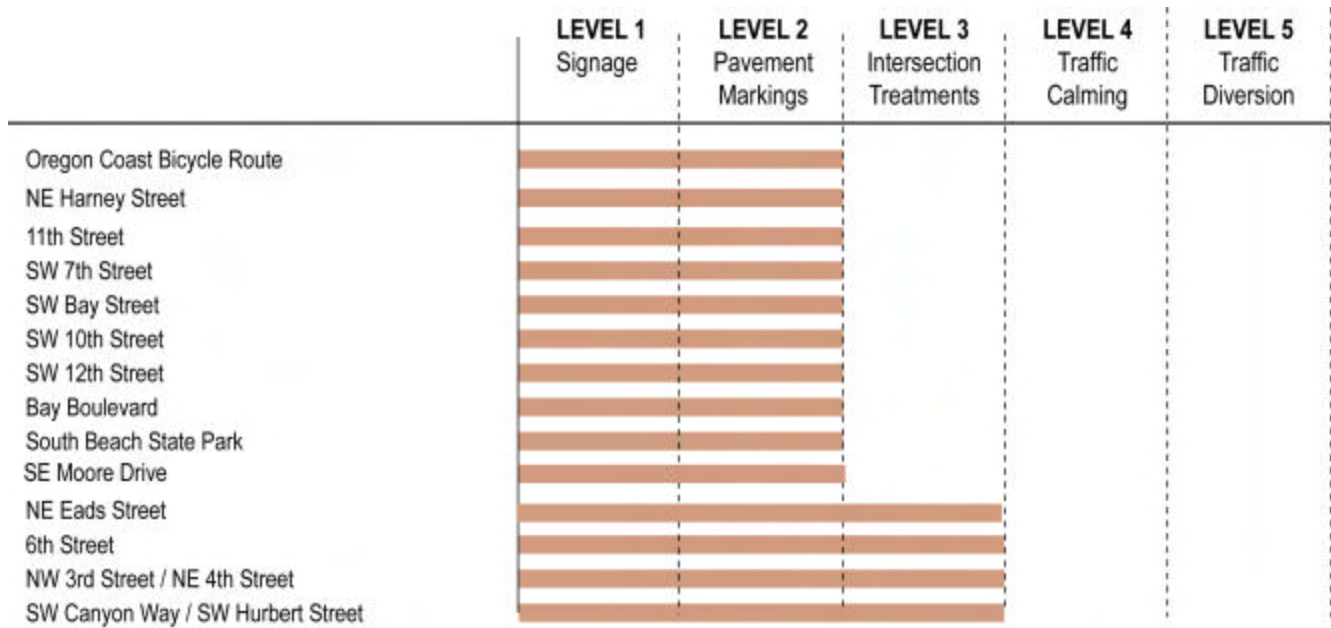

Figure 3-3. Recommended Bicycle Boulevard Applications by Street

## Project Prioritization

Several evaluation criteria were developed to identify and prioritize projects for improving Newport’s walking and bicycling environment. Specifically, the criteria were applied in two ways:

- To lay out the best possible future pedestrian/bicycle network by identifying the features of a network most important to the residents of Newport
- To rank projects against each other as an indication of their relative importance

The goal was to develop three tiers of project priorities so that the City may focus funding and funding applications on the highest priority projects. Each evaluation criterion was assigned a range of points, with the number of potential points reflecting the criterion’s relative importance. Specific evaluation criteria used in this Plan include the following:

- *Connectivity*: To what degree does the project fill a missing gap in the bicycle and/or pedestrian system?
- *User Generator*: To what degree will the project likely generate transportation or recreational usage based on population, corridor aesthetics, etc.?
- *Land Uses*: How many user generators does the project connect within one-fourth to one-half of a mile, such as schools, parks, hospitals, EOU, employment and commercial districts, etc.?
- *Overcomes Barrier*: How well does the project overcome a barrier in the current bicycle and pedestrian network?
- *Safety and Comfort*: Can the project potentially improve bicycling and walking at locations with perceived or documented safety issues? This criterion takes into account available crash data as well as feedback from the local bicycling and walking community.





- *Regional Benefit*: To what degree does the project offer potential benefits to the wider, regional community by offering opportunities for increased connectivity to parks, view points, connections to Newport and Lincoln County bicycle/pedestrian facilities, etc.?
- *Ease of Implementation*: How difficult will it be to implement the project? This criterion takes into account constraints like topography, existing development, and environmental, political and economic issues, which should be considered only after the project has been evaluated on merit.

Using the above criteria, each project was ranked based on information obtained from site visits, field work, City officials and the public; and grouped the projects into Tier 1 (short-term), Tier 2 (medium-term) and Tier 3 (long-term) priorities.

The short-, medium-, and long-term priorities may change according to available funds, changing priorities, new roadway projects that coincide, new development and redevelopment opportunities, or other factors.

It should be noted that the purpose of this exercise is to understand the relative priority of the projects so that the City may apportion available funding to the highest priority projects. Medium- and long-term projects are also important, and may be implemented at any point in time as part of a development or public works project. The ranked lists should be considered a “living document” and should be frequently reviewed to ensure they reflect current Newport priorities.

The list of proposed pedestrian and bicycle projects (and relative prioritization) is located at the end of this chapter.

## Project Costs

This section summarizes planning level cost estimates associated with the recommended pedestrian and bicycle improvement projects. The estimates were based on similar Pedestrian and Bicycle Plans and experience in other communities. Table 3-2 summarizes cost estimates for individual pedestrian and bicycle treatments, while Table 3-3 at the end of this chapter summarizes costs by project. The estimates also include contingency and construction management costs, which represent a proportion of the original project costs.

The table at the end of this chapter provides cost estimates for individual projects proposed in this Plan. The table below provides a cost summary for Tier 1, Tier 2 and Tier 3 projects combined. The total implementation cost of the Pedestrian and Bicycle Plan is estimated at approximately \$40.9 million. It should be noted that this estimate includes \$20 million for improvements to the Yaquina Bay Bridge for bicyclists and pedestrians. Chapter 6 discusses potential funding sources for implementing projects in this Plan.

**Table 3-1. Planning Level Cost Estimates for Tier 1, 2, and 3 Projects**

Projects	Planning Level Cost Estimate
Tier 1	\$7,290,500
Tier 2	\$6,908,500
Tier 3	\$26,688,000
<b>Total</b>	<b>\$40,887,000</b>



*This page intentionally left blank*



**Table 3-2. Planning Level Unit Cost Estimates for Newport Projects**

Item	Unit	Unit Cost	Source	Comments
Curb ramp (dual)	Each	\$2,500	City of Santa Barbara, CA Pedestrian Master Plan (adopted 2006)	
Detectable warning strip (truncated domes)	Each	\$300	City of Santa Barbara, CA Pedestrian Master Plan (adopted 2006)	
Curb extension	Each	\$5,000	City of Santa Barbara, CA Pedestrian Master Plan (adopted 2006)	Minor curb extension without landscaping
Sidewalk	Linear Foot	\$35	City of Wilsonville, OR Bicycle and Pedestrian Master Plan (adopted 2006)	
Longitudinal Crosswalk	Each	\$600	Previous pedestrian and bicycle planning projects conducted by Alta Planning + Design	Thermoplastic bars measuring 2' x 10'
Transverse (parallel bar) crosswalk	Linear Foot	\$170	Previous pedestrian and bicycle planning projects conducted by Alta Planning + Design	Thermoplastic bars
Pedestrian refuge island	Each	\$20,000	City of Santa Barbara, CA Pedestrian Master Plan (adopted 2006)	
Bicycle lane (street widening)	Mile	\$300,000	City of Wilsonville, OR Bicycle and Pedestrian Master Plan (adopted 2006)	Both sides of street
Bicycle lane (signing and striping only)	Mile	\$25,000	City of Wilsonville, OR Bicycle and Pedestrian Master Plan (adopted 2006)	Both sides of street
Blue bicycle lane (striping and paint)	Linear Foot	\$45	City of Portland, OR	6' wide on State highway, one side of street
Supplemental bicycle lane striping (fog line and hash marks)	Mile	\$34,000	City of Santa Barbara, CA Pedestrian Master Plan (adopted 2006)	Both sides of street
Roadway shoulder (rural roadways)	Mile	\$635,000	Florida Dept. of Trans. "2004 Transportation Costs"	Both sides of street
Stop sign	Each	\$200	City of Santa Barbara, CA Pedestrian Master Plan (adopted 2006)	
Warning sign	Each	\$200	City of Santa Barbara, CA Pedestrian Master Plan (adopted 2006)	
In-street Pedestrian Crossing Sign with mounting device	Each	\$200	City of Santa Barbara, CA Pedestrian Master Plan (adopted 2006)	
Shared-use path	Mile	\$400,000	City of Wilsonville, OR Bicycle and Pedestrian Master Plan (adopted 2006)	Cross-section includes 2' shoulder, 12' paved surface, and 6' unpaved surface; cost excludes treatments for path/ roadway crossings
Shared-use path feasibility study	Mile	\$20,000 – \$100,000	Previous trail feasibility studies conducted by Alta Planning + Design	Depends on complexity of issues, such as environmental analysis, land ownership, topography, public process, etc.
Type 1 path/roadway crossing	Each	\$5,000	City of Wilsonville, OR Bicycle and Pedestrian Master Plan (adopted 2006)	
Type 1+ path/roadway crossing	Each	\$15,000	City of Wilsonville, OR Bicycle and Pedestrian Master Plan (adopted 2006)	
Type 2 path/roadway crossing	Each	\$10,000	City of Wilsonville, OR Bicycle and Pedestrian Master Plan	



Newport Pedestrian and Bicycle Plan

Item	Unit	Unit Cost	Source	Comments
			(adopted 2006)	
Type 3 path/roadway crossing	Each	\$100,000	City of Wilsonville, OR Bicycle and Pedestrian Master Plan (adopted 2006)	
Level 1 bicycle boulevard applications	Mile	Wayfinding sign: \$125 Warning sign: \$200	City of Portland, OR; City of Wilsonville, OR Bicycle and Pedestrian Master Plan (adopted 2006)	Approx. 12 wayfinding signs per mile; number of warning signs depends on location
Level 2 bicycle boulevard applications	Mile	Sharrow: \$120 Directional marking: \$20	City of Portland, OR	One sharrow per 200 feet (both sides of street), or one directional marking per 600 feet (both sides of street) and at key intersections
Level 3 bicycle boulevard applications	By project	Stop sign: \$200 Bike loop detector: \$3,000 Curb extension: \$5,000 Median/ refuge island: \$20,000 Half signal: \$100,000	City of Berkeley, CA; City of Santa Barbara, CA Pedestrian Master Plan (adopted 2006)	Type and number of treatments depend on location
Level 4 bicycle boulevard applications	By project	Chicane: \$20,000 Mini traffic circle: \$4,000 Speed hump: \$2,000	City of Seattle, WA; City of Santa Barbara, CA Pedestrian Master Plan (adopted 2006)	Type and number of treatments depend on location
Level 5 bicycle boulevard applications	By project	Choker entrance: \$8,000 Traffic diverter: \$20,000	City of Santa Barbara, CA Pedestrian Master Plan (adopted 2006)	Type and number of treatments depend on location
Contingency	--	30% of original project cost	City of Wilsonville, OR Bicycle and Pedestrian Master Plan (adopted 2006)	Addresses potential inflation costs of materials and labor, and time leading to a project's implementation
Design and Construction Management	--	25% of original project cost	City of Wilsonville, OR Bicycle and Pedestrian Master Plan (adopted 2006)	



**Table 3-3. Recommended Pedestrian and Bicycle Projects**

Newport Project Matrix					
Project	From – to	Description	Lead Responsibility	Priority (Tier 1, 2, 3)	Planning Level Cost Estimate (excluding property acquisitions and easements) <sup>4</sup>
US 101 Crossings					
NW 68 <sup>th</sup> Undercrossing	n/a	An undercrossing of US 101 at NW 68 <sup>th</sup>	ODOT / Newport	3	\$2,000,000
Mid-block between 16 <sup>th</sup> Street & 17 <sup>th</sup> Street	n/a	Add median, raised stop bars, appropriate signage, and striped continental crosswalk	ODOT / Newport	3	\$225,000
13 <sup>th</sup> Street	n/a	Add median, raised stop bars, appropriate signage, and striped continental crosswalk	ODOT / Newport	3	\$225,000
10 <sup>th</sup> Street	n/a	Add median, raised stop bars, appropriate signage, and striped continental crosswalk	ODOT / Newport	2	\$225,000
8 <sup>th</sup> Street	n/a	Add median, raised stop bars, appropriate signage, and striped continental crosswalk	ODOT / Newport	2	\$225,000
3 <sup>rd</sup> Street / 4 <sup>th</sup> Street	n/a	Add median, raised stop bars, appropriate signage, and striped continental crosswalk	ODOT / Newport	1	\$225,000
2 <sup>nd</sup> Street (outside City Hall)	n/a	Add median, raised stop bars, appropriate signage, and striped continental crosswalk	ODOT / Newport	1	\$225,000
SW Angle Street	n/a	Add curb extensions	ODOT / Newport	1	\$32,000
SW Lee Street	n/a	Add curb extensions	ODOT / Newport	1	\$32,000
SW Hurbert Street	n/a	Add curb extensions	ODOT / Newport	1	\$32,000
SW Alder Street	n/a	Add curb extensions	ODOT / Newport	1	\$32,000
SW Neff Way	n/a	Add median, raised stop bars, appropriate signage, and striped continental crosswalk	ODOT / Newport	2	\$225,000
SW Abbey Street	n/a	Tighten the turning radius for vehicles, add marked crosswalks.	ODOT / Newport	3	\$175,000
SW Bay Street	n/a	Tighten the turning radius for vehicles, add marked crosswalks.	ODOT / Newport	3	\$175,000
Mid-block between SW Bayley Street & SW Minnie Street	n/a	Add median, raised stop bars, appropriate signage, striped continental crosswalk, and curb extensions	ODOT / Newport	2	\$225,000



Newport Project Matrix

Project	From – to	Description	Lead Responsibility	Priority (Tier 1, 2, 3)	Planning Level Cost Estimate (excluding property acquisitions and easements) <sup>4</sup>
<b>Sidewalks</b>					
NE Avery Street	US 101 to end of street	Construct sidewalk on west side of street	Newport	2	\$187,000
NE 71 <sup>st</sup> Street	NE Avery Street to NE Echo Ct	Construct sidewalk on south side of street	Newport	3	\$98,000
NE 70 <sup>th</sup> Street	NE Avery Street to fire access easement road	Construct sidewalk on north side of street	Newport	3	\$66,700
Fire Access Easement	NE 70 <sup>th</sup> Street to NE 71 <sup>st</sup> Street	Construct pedestrian accessway	Newport	3	\$15,000
US 101	NE Avery Street to Agate Beach Access Road	Construct sidewalk on west side of street	ODOT / Newport	3	\$595,000
NE 57 <sup>th</sup> Street	US 101 to NE Evergreen Lane	Construct sidewalk on south side of street	Newport	2	\$107,000
NE Evergreen Lane	End of street to NE 54 <sup>th</sup> Street	Construct sidewalk on west side of street	Newport	3	\$207,000
NE 54 <sup>th</sup> Street	NE Evergreen Lane to NE 56 <sup>th</sup> Street	Construct sidewalk north side of street	Newport	3	\$51,000
NE 56 <sup>th</sup> Street	NE 54 <sup>th</sup> Street to NE Lucky Gap Street	Construct sidewalk on east/south of street	Newport	3	\$72,000
NE Lucky Gap Street	NE 56 <sup>th</sup> Street to NE 57 <sup>th</sup> Street	Construct sidewalk on east side of street	Newport	3	\$46,000
NW 60 <sup>th</sup> Street	US 101 to end of street	Construct sidewalks on both sides of street	Newport	2	\$132,000
NW 58 <sup>th</sup> Street	US 101 to end of street	Construct sidewalks on both sides of street	Newport	2	\$190,000
NW 57 <sup>th</sup> Street	NW Gladys Street to end of street / NW Biggs Street to end of street	Construct sidewalk on south side of street	Newport	3	\$94,500
NW 56 <sup>th</sup> Street	US 101 Access Road to end of street	Construct sidewalk on south side of street	Newport	2	\$120,000
NW 55 <sup>th</sup> Street	US 101 to end of street	Construct sidewalk on north side of street	Newport	2	\$135,000
NW Rhododendron Street	NW 55 <sup>th</sup> Street to NW 60 <sup>th</sup> Street	Construct sidewalk on east side of street	Newport	2	\$87,000



3. Recommended Pedestrian and Bicycle Network

Newport Project Matrix

Project	From – to	Description	Lead Responsibility	Priority (Tier 1, 2, 3)	Planning Level Cost Estimate (excluding property acquisitions and easements) <sup>4</sup>
NW Biggs Street	NW 56 <sup>th</sup> Street to NW 60 <sup>th</sup> Street	Construct sidewalks on both side of street	Newport	2	\$131,000
NW Gladys Street	NW 56 <sup>th</sup> Street to NW 60 <sup>th</sup> Street	Construct sidewalks on west side of street	Newport	3	\$76,000
NW Lighthouse Drive	US 101 to end of street	Construct sidewalks on north side of street	Newport	3	\$285,000
NE Harney Street	US 101 to NE Big Creek Road	Construct sidewalks on south side of street	Newport	2	\$178,000
NE Lakewood Drive	NE Harney Street to end of street	Construct sidewalk on one side of street	Newport	2	\$160,000
NE Crestview Drive	NE 20 <sup>th</sup> Street to end of street	Complete sidewalk gaps on west side of street	Newport	3	\$29,000
NE Crestview Place	NE 20 <sup>th</sup> Street to end of street	Construct sidewalks on west side of street	Newport	3	\$53,000
NE 20 <sup>th</sup> Place	NE 20 <sup>th</sup> Street to end of street	Construct sidewalks on south side of street	Newport	3	\$52,000
NE Douglas Street	NE 20 <sup>th</sup> Place to end of street	Construct sidewalks on west side of street	Newport	3	\$50,000
NW Oceanview Drive	US 101 to NW Spring Street	Construct sidewalks on west side of street	Newport	3	\$420,000
NW Spring Street	NW Oceanview Drive to NW 8 <sup>th</sup> Street	Construct sidewalks on west side of street	Newport	2	\$88,000
NW 8 <sup>th</sup> Street	NW Spring Street to NW Coast Street	Construct sidewalks on north side of street	Newport	2	\$27,000
NW 15 <sup>th</sup> Street	NW Oceanview Drive to NW Grove Street	Construct sidewalks on south side of street	Newport	3	\$58,000
NW 12 <sup>th</sup> Street	NW Spring Street to just east of NW Nye Street	Construct sidewalks on south side of street	Newport	2	\$74,000
NW 11 <sup>th</sup> Street	NW Spring Street to US 101	Complete sidewalk gaps on both sides of the street	Newport	1	\$111,000
NW 10 <sup>th</sup> Street	NW Spring Street to NW Nye Street	Construct sidewalk on south side of street	Newport	2	\$67,000
NW 6 <sup>th</sup> Street	NW Coast Street to NW Nye Street	Construct sidewalks on both sides of street	Newport	1	\$184,000
NW 3 <sup>rd</sup> Street	NW Hubert Street to US 101	Complete sidewalk gaps on north side of street	Newport	1	\$81,000
NE 12 <sup>th</sup> Street	US 101 to NE Benton Street	Complete sidewalk gaps on south side of street	Newport	1	\$51,000
NE 8 <sup>th</sup> Street	US 101 to NE Eads Street	Construct sidewalks on one side of the street	Newport	2	\$107,000



Newport Project Matrix

Project	From – to	Description	Lead Responsibility	Priority (Tier 1, 2, 3)	Planning Level Cost Estimate (excluding property acquisitions and easements) <sup>4</sup>
NE 7 <sup>th</sup> Street	US 101 to NE Eads Street	Construct sidewalks on one side of the street	Newport	1	\$107,000
NE Jeffries Place	NE 7 <sup>th</sup> Street to end of street	Construct sidewalks on west side of street	Newport	3	\$33,000
NE 7 <sup>th</sup> Drive	NE 7 <sup>th</sup> Street to end of street	Construct sidewalks on west side of street	Newport	3	\$80,000
NE 6 <sup>th</sup> Street	NE 7 <sup>th</sup> Drive to end of street	Construct sidewalks on south side of street	Newport	3	\$84,000
NE 4 <sup>th</sup> Street	US 101 to NE Douglas Street	Construct sidewalks on both sides of the street	Newport	1	\$145,000
NE 3 <sup>rd</sup> Street	NE Eads Street to NE Harney Street	Complete sidewalk gaps on both sides of street	Newport	1	\$117,000
NE 2 <sup>nd</sup> Street	US 101 to NE Eads Street	Complete sidewalk gaps on both sides of street	Newport	2	\$106,500
SE 1 <sup>st</sup> Street	US 101 to SE Douglas Street	Construct sidewalks on south side of street	Newport	1	\$89,000
SE 2 <sup>nd</sup> Street	SE Benton Street to SE Douglas Street	Construct sidewalks on south side of street	Newport	1	\$39,000
SE Benton Street	SE 1 <sup>st</sup> Street to US 20	Construct sidewalks on west side of street	Newport	1	\$15,000
SE Coos Street	SE 2 <sup>nd</sup> Street to US 20	Construct sidewalk on west side of street	Newport	2	\$33,000
SE Douglas Street	SE 2 <sup>nd</sup> Street to US 20	Construct sidewalk on west side of street	Newport	2	\$33,000
SE 2 <sup>nd</sup> Street	SE Fogarty Street to SE Harney Street	Construct sidewalks on south side of street	Newport	1	\$38,000
SE 4 <sup>th</sup> Street	SE Fogarty Street to SE Harney Street	Construct sidewalks on south side of street	Newport	1	\$38,000
SE Harney Street	SE 4 <sup>th</sup> Street to SE 2 <sup>nd</sup> Street	Construct sidewalks on east side of street	Newport	1	\$33,000
Bay Blvd	Length of street	Complete sidewalk gaps on both side of street	Newport	2	\$157,500
SW Hatfield Drive	SW Bay Blvd to SW 10 <sup>th</sup> Street	Construct sidewalks on west side of street	Newport	3	\$57,000
SW Harbor Drive	SW Bay Street to SW 11 <sup>th</sup> Street	Construct sidewalks on west side of street	Newport	1	\$43,500
SW Neff Way / SW Alder Street	US 101 to SW 2 <sup>nd</sup> Street	Construct sidewalks on both sides of street	Newport	1	\$143,000
SW 7 <sup>th</sup> Street	SW Alder Street to SW Elizabeth Street	Construct sidewalks on north side of street	Newport	2	\$152,000
SW Elizabeth Street	SW Government Street to SW Abbey Street	Construct sidewalk on west side of street	Newport	1	\$121,000





3. Recommended Pedestrian and Bicycle Network

Newport Project Matrix

Project	From – to	Description	Lead Responsibility	Priority (Tier 1, 2, 3)	Planning Level Cost Estimate (excluding property acquisitions and easements) <sup>4</sup>
SW Government Street / Yaquina State Park	Yaquina State Park	Construct sidewalk adjacent to road through park	State Parks / Newport	3	\$116,000
SE OSU Drive	SE 26 <sup>th</sup> Street to end of street	Construct sidewalks on both sides of street	Newport	2	\$210,000
SE OSU Drive	SW Abalone Street to SE Ferry Slip Road	Construct sidewalks on north side of street	Newport	2	\$67,500
SE Ferry Slip Road	SE 29 <sup>th</sup> Street to SE OSU Drive	Construct sidewalks on west side of street	Newport	1	\$91,000
SW Abalone Street	SE OSU Drive to US 101	Construct sidewalks on west side of street	Newport	1	\$100,000
SW Brant Street	SW Abalone Street to end of street	Construct sidewalks on west side of street	Newport	1	\$91,000
SE 35 <sup>th</sup> Street	SE Ferry Slip Road to end of street	Construct sidewalk on one side of street	Newport	1	\$337,500
US 101	SE Ash Street to South Beach State Park	Construct sidewalk on west side of road	ODOT / Newport	3	\$250,000
US 101	SW Abalone Street to SE 32 <sup>nd</sup> Street	Construct sidewalk on west side of road	ODOT / Newport	2	\$32,000
SE Fogarty Street	US 20 to SE Bay Blvd	Construct sidewalk on east side of street	Newport	2	\$93,000
NE 36 <sup>th</sup> Street	US 101 to NE Harney Street	Construct sidewalk on one side of street	Newport	2	\$114,000
NE 10 <sup>th</sup> Court	NE Eads to NE Benton Street	Construct sidewalks on both sides of street	Newport	2	\$100,000
NE 10 <sup>th</sup> Street	NE Benton Street to US 101	Construct sidewalks on both sides of street	Newport	2	\$105,000
NE 5 <sup>h</sup> Street	NE Benton Street to NE Eads Street	Construct sidewalks on both sides of street	Newport	2	\$106,000
NE Fogarty Street	US 20 to NE 3 <sup>rd</sup> Street	Construct sidewalks on both sides of street	Newport	2	\$95,000
SE Moore Drive	Bay Boulevard to SE 2 <sup>nd</sup> Street	Construct sidewalk on west side of road	Newport	2	\$106,000
SE 2 <sup>nd</sup> Street	SE Moore Drive west	Construct sidewalks on both sides of street	Newport	2	\$19,000
SE 5 <sup>h</sup>	SE Moore Dr to SE Fogarty St	Construct sidewalks on both sides of the street	Newport	2	\$150,000
San Bay -O Circle	Proposed connection to Crestview to proposed connection to Chambers Ct	Construct sidewalk along one side of street from proposed connection to Crestview and to Chambers Court	Newport	2	\$41,000



Newport Project Matrix

Project	From – to	Description	Lead Responsibility	Priority (Tier 1, 2, 3)	Planning Level Cost Estimate (excluding property acquisitions and easements) <sup>4</sup>
<b>Sidewalks and Bike Lanes</b>					
NW Nye Street	NW 15 <sup>th</sup> Street to SW 2 <sup>nd</sup> Street	Construct bicycle lanes on both sides of street and complete sidewalk gaps on east side of street	Newport	1	\$166,000
NE Benton Street / NE Coos Street	NE 12 <sup>th</sup> Street to US 20	Construct bicycle lanes and sidewalks on both sides of street	Newport	2	\$439,000
NE 7 <sup>th</sup> Street	NE Eads Street to NE 6 <sup>th</sup> Street	Construct bicycle lanes and sidewalks on both sides of street and sidewalks on south side of street	Newport	1	\$180,000
NE Harney Street	US 20 to NE 3 <sup>rd</sup> Street	Construct bicycle lanes and sidewalks on both sides of street and sidewalks on south side of street	Newport	2	\$77,000
US 20	NE Harney Street / SE Moore Drive to US 101 intersection	Construct bicycle lanes and fill in sidewalk gaps on both sides of street	ODOT / Newport	2	\$47,000
SE Bay Blvd	SE Moore Drive to SE Vista Drive	Construct bicycle lanes and sidewalks as described in ODOT grant application	Newport	1	The city has received grant monies
SW 10 <sup>th</sup> Street	SW Hatfield Drive to SE 2 <sup>nd</sup> Street	Stripe bicycle lanes on south side of street and fill in sidewalk gaps on both sides of street	Newport	2	\$38,000
SW 2 <sup>nd</sup> Street	SW Nye Street to SW Coast Street	Stripe bicycle lanes on both sides of the street and complete sidewalk gaps on north side of the street	Newport	3	\$61,000
SW Naterlin Drive	SW Bay Street to US 101	Construct bicycle lanes and sidewalks on south side of street	Newport	2	\$94,000
<b>Bicycle Lanes</b>					
SW Canyon Way	SW Fall Street to SW 9 <sup>th</sup> Street	Construct bicycle lane on east side of street	Newport	3	\$9,000
US 101	Yaquina Bay Bridge to South Beach State Park Access	Stripe bicycle lanes on both sides of street	ODOT	3	\$54,000
West Olive	US 101 to SW Elizabeth St	Stripe bicycle lanes on both sides of street	Newport	2	\$20,000



3. Recommended Pedestrian and Bicycle Network

Newport Project Matrix

Project	From – to	Description	Lead Responsibility	Priority (Tier 1, 2, 3)	Planning Level Cost Estimate (excluding property acquisitions and easements) <sup>4</sup>
New Boat Launch Pathway	OSU Drive to New Boat Launch	Designate bike and pedestrian lane on access road on Northern edge of parking lot	Port	3	\$9,000
<b>Shared Roadways / Bicycle Boulevards</b>					
Oregon Coast Bicycle Route	US 101 to Yaquina Bay Bridge	Implement Level 1 and 2 bicycle boulevard applications (signage, pavement markings)	Newport	2	\$7,000
NE Harney Street	US 101 to NE Big Creek Road	Implement Level 1 and 2 bicycle boulevard applications (signage, pavement markings)	Newport	3	\$1,500
11 <sup>th</sup> Street	NW Spring Street to NE Eads Street	Implement Level 1 and 2 bicycle boulevard applications (signage, pavement markings)	Newport	1	\$1,500
6 <sup>th</sup> Street	NW Coast Street to NE Eads Street	Implement Level 1, 2, and 3 bicycle boulevard applications (signage, pavement markings, intersection treatments)	Newport	1	\$1,700
NW 3 <sup>rd</sup> Street / NE 4 <sup>th</sup> Street	NW Coast Street to NE Eads Street	Implement Level 1, 2, and 3 bicycle boulevard applications (signage, pavement markings, intersection treatments)	Newport	2	\$2,300
SW 7 <sup>th</sup> Street	SW 2 <sup>nd</sup> Street to SW Elizabeth Street	Implement Level 1 and 2 bicycle boulevard applications (signage, pavement markings)	Newport	2	\$1,500
SW 10 <sup>th</sup> / 9 <sup>th</sup> Street	SE 2 <sup>nd</sup> Street to SW Bay Street	Implement Level 1, 2, and 3 bicycle boulevard applications (signage, pavement markings, intersection treatments)	Newport	1	\$2,200
SW Canyon Way / SW Hubert Street	SW Bay Blvd to NW 6 <sup>th</sup> Street	Implement Level 1, 2, and 3 bicycle boulevard applications (signage, pavement markings, intersection treatments)	Newport	1	\$1,900
SW Bay Street	SW 9 <sup>th</sup> Street to SW 12 <sup>th</sup> Street	Implement Level 1 and 2 bicycle boulevard applications (signage, pavement markings)	Newport	1	\$400
SW 10 <sup>th</sup> Street / SW 12 <sup>th</sup> Street	SW Bay Street to US 101	Implement Level 1 and 2 bicycle boulevard applications (signage, pavement markings)	Newport	1	\$700
Bay Blvd	SW Naterlin Drive to SE Moore Drive	Implement Level 1 and 2 bicycle boulevard applications (signage, pavement markings)	Newport	2	\$2,500
South Beach State Park	US 101	Implement Level 1 and 2 bicycle boulevard applications (signage, pavement markings)	Newport	3	\$2,300
NE Eads Street	US 20 to NE 12 <sup>th</sup> Street	Implement Level 1, 2, and 3 bicycle boulevard applications (signage, pavement markings, intersection treatments)	Newport	1	\$15,000



Newport Project Matrix

Project	From – to	Description	Lead Responsibility	Priority (Tier 1, 2, 3)	Planning Level Cost Estimate (excluding property acquisitions and easements) <sup>4</sup>
SE Moore Drive	Bay Blvd to US 20	Implement Level 1 and 2 bicycle boulevard applications (signage, pavement markings)	Newport	1	\$1,000
OSU Drive	US 101 to end	Implement Level 1 and 2 bicycle boulevard applications (signage, pavement markings)	Newport	1	\$2,000
SW 26 <sup>th</sup> Street	US101 to west of town	Implement Level 1 and 2 bicycle boulevard applications (signage, pavement markings)	Newport	2	\$500
Old Boat Launch access	US 101 to old boat launch	Implement Level 1 and 2 bicycle boulevard applications (signage, pavement markings)	Newport	3	\$14,000
<b>Shared-use Paths</b>					
NE Big Creek Road	NE Harney Street to NE 12 <sup>th</sup> Street	Construct a shared-use path along the NE Big Creek right-of-way	Newport	2	\$440,000
SE 2 <sup>nd</sup> Street Bridge	Se Douglas Street to SE Fogarty Street	Construct a non-motorized shared-use bridge over the existing ravine to provide a more direct connection to Yaquina View Elementary School from the nearby residential areas	Newport	3	\$1,500,000 - \$3,000,000
Yaquina Bay Bridge	Bridge	Provide a dedicated travel space for bicyclists and pedestrians	Newport	3	\$15,000,000-\$20,000,000
North Jetty Trail	SW Naterlin Drive to north jetty	Construct a shared-use path out the north jetty	Newport	1	\$780,000
South Jetty Trail	SW 26 <sup>th</sup> Street to south jetty	Construct a shared-use path out along the south jetty	Newport / Oregon State Parks	2	\$450,000
San-Bay -O Connection	San-Bay -O Circle to NE Crestview	Construct a shared-use path connection, requires an easement over private property. Exact location uncertain.	Newport	2	\$35,000
Route to Main Shopping Area	NE Chambers Ct to Frank Wade Park and Park to San-Bay -O Circle	Construct a shared-use path connecting to main shopping area	Newport	1	\$82,000
Path across old RV park	SE Pacific Way to OSU Drive	Improve pathway through RV park, route pedestrians off blind corner at SE Pacific Drive and OSU Drive	Newport	1	\$500
Estuary Trail Access	SE 35 <sup>th</sup> Street to Chestnut Street	Provide a dedicated travel space for bicyclists and pedestrians as an alternative to Idaho Point Road	Newport	2	\$175,000



Newport Project Matrix

Project	From – to	Description	Lead Responsibility	Priority (Tier 1, 2, 3)	Planning Level Cost Estimate (excluding property acquisitions and easements) <sup>4</sup>
Connector to OCCC	SE 35 <sup>th</sup> to OCCC	Provide a dedicated travel space for bicyclists and pedestrians	Newport	2	\$450,000
Ash Extension	Ash Street end to SE 35 <sup>th</sup>	Provide a dedicated travel space for bicyclists and pedestrians along railway right-of-way		2	\$191,000
Connector to US 101 Stairways	US 101 to SW 26 <sup>th</sup> and SW 27 <sup>th</sup> Avenues	Provide access to US 101 stairways	Newport	1	\$79,000
Connector to US 101 Bridge	SW 26 <sup>th</sup> (South Jetty Road) to US 101 Bridge	Continues to the improvements on the east side of the US 101 bridge to OSU Drive	Newport	2	\$60,000
Development of SW Coho Street	South Jetty Road to SW 30 <sup>th</sup> Street	Provides pedestrian access on unimproved road	Newport	2	\$99,000
Connector – SW 29 <sup>th</sup> Street or SW 30 <sup>th</sup> Street	State Park and South Beach neighborhood	Links into State Park trail system	Newport	1	\$35,000
Connector	SW 26 <sup>th</sup> to State Park	Links into State Park trail system	Newport	1	\$83,000
Connector	State Park to South Shore	Links into State Park trail system	Newport	2	\$156,000
Connector	South Shore to Airport	Links State Park trail system to airport	Newport	3	\$869,000
Yaquina Bay Estuary Trail Extension	Yaquina Bay Trail to SE 35 <sup>th</sup> Street	Extends existing trail	Newport	1	\$321,000
NW Coast Street	NW 8 <sup>th</sup> to NW 11 <sup>th</sup>	Provide bicycle and pedestrian improvements over existing gravel road	Newport	2	\$113,000
Nye Street	NW 15 <sup>th</sup> and Nye St to NW 18 <sup>th</sup> and Oceanview	Construct shared use path connecting Nye to Oceanview	Newport	2	\$110,000



*This page intentionally left blank*



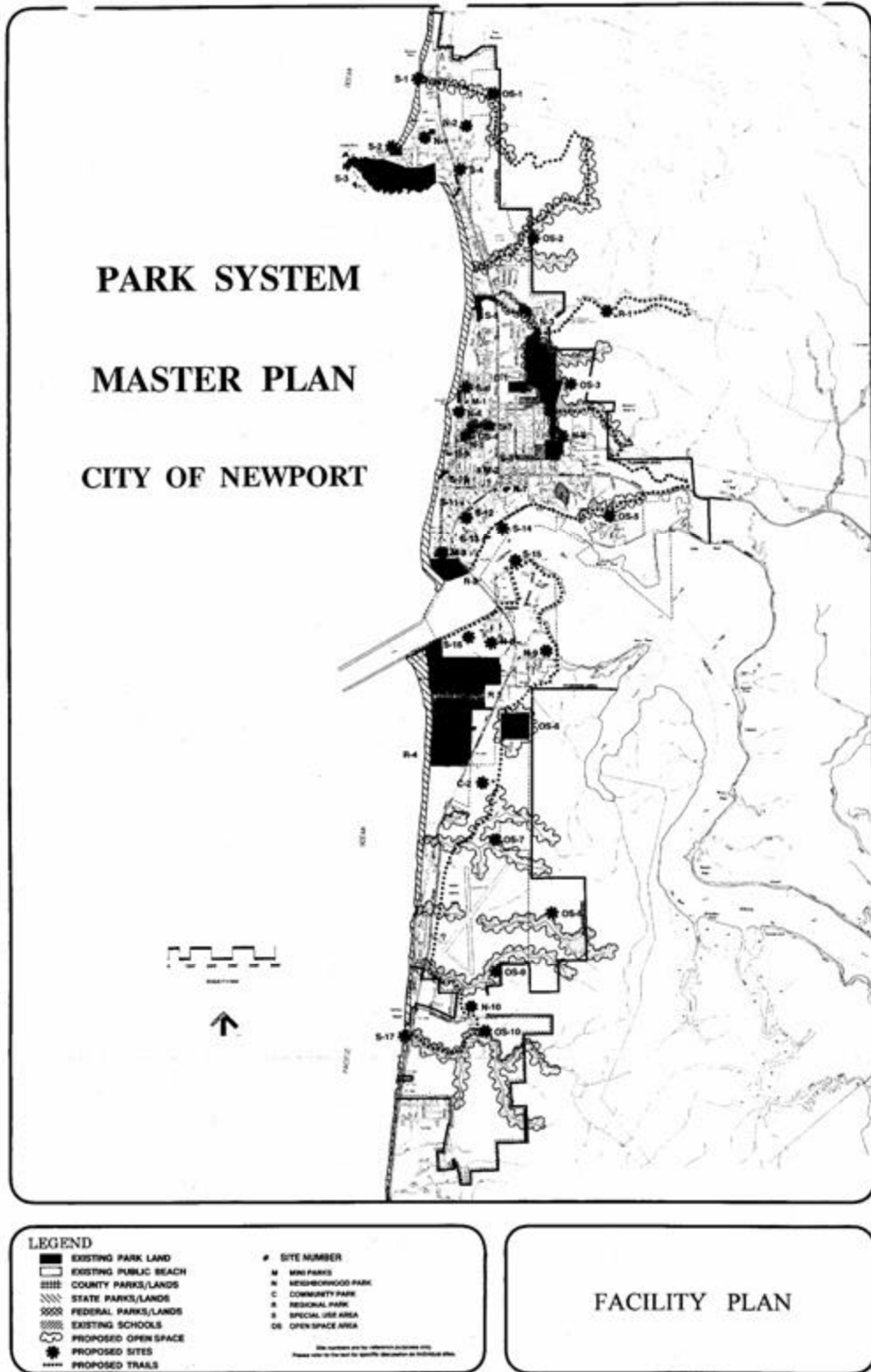

Map 3-7 1994 Newport Parks System Master Plan

*This page intentionally left blank*





# Newport

## Pedestrian & Bicycle Plan



### 4. RECOMMENDED PEDESTRIAN AND BICYCLE PROGRAMS

#### Introduction

Bicycle and pedestrian programs enhance the biking and walking experience in ways other than the provision of traditional walkways and bikeways. Support programs include educational programs, the provision of bicycle parking, and various city programs and policies.

#### Safe Routes to School

Safe Routes to School (SR2S) refers to a variety of multi-disciplinary programs aimed at promoting walking and bicycling to school, and improving traffic safety around school areas through education, incentives, increased law enforcement, and engineering measures. Safe Routes to School programs typically involve partnerships among municipalities, school districts, community and parent volunteers, and law enforcement agencies. Newport's SR2S efforts are a vital component of the Pedestrian and Bicycle Plan, as they will facilitate the implementation and funding for specific improvements that will help increase bicyclist and pedestrian safety and encourage fewer auto trips.



Student escorting fellow students across the street

The City has a vested interest in encouraging schoolchildren to lead active lifestyles. Safe Routes to School programs offer ancillary benefits to neighborhoods by helping to slow traffic and provide reasonable facilities for walking by all age groups. The City benefits from a generally well-connected street system near most schools, a critical element in encouraging children to bike and walk to school.

## Why Do We Need SR2S?

The purpose of a SR2S program is to identify and improve school commute routes, to increase the number of students who walk and/or bicycle to school in Newport, to lessen traffic congestion, and to improve health. Although most children walked or biked to school before and during the 1980s, the number of children walking or bicycling to school has sharply declined since, due to urban growth patterns and design, which have made it less safe to do so, in addition to other factors such as higher obesity rates and changes in lifestyle emphasizing more driving. Walking and bicycling to school are healthy alternatives to being driven and can provide a sense of independence for children who may otherwise be restricted by school bus or parents' schedules.

## What are the Benefits of a SR2S Program?

The primary benefit of implementing a SR2S program is the resulting increase in safety for children walking and riding bicycles to school. A comprehensive strategy based on a cooperative effort between school officials, parents, residents and city planning staff will ensure that specific school-related traffic calming projects and pedestrian and bicycle improvements will become priority projects eligible for State, Federal or other grant funding. The involvement of various stakeholders throughout the Safe Routes process increases the likelihood for implementation of needed safety improvements. While the primary focus of a SR2S program is improving safety for children walking and biking to school, these safety benefits often extend to all age and activity groups. In addition to safety enhancements, a SR2S program helps integrate physical activity into the everyday routine of schoolchildren. Health concerns related to sedentary lifestyles have become the focus of efforts both statewide and nationally to reduce health risks associated with being overweight. Identifying and improving routes for children to safely walk and bicycle to school is one of the most cost-effective means of reducing weekday morning traffic congestion (especially at school drop-off and pick-up sites) and can help reduce auto-related pollution.



Children walking to school

Health concerns related to sedentary lifestyles have become the focus of efforts both statewide and nationally to reduce health risks associated with being overweight. Identifying and improving routes for children to safely walk and bicycle to school is one of the most cost-effective means of reducing weekday morning traffic congestion (especially at school drop-off and pick-up sites) and can help reduce auto-related pollution.

## Local Coordination and Involvement

In order to be successful, a SR2S program in Newport will need buy-in from individuals and organizations throughout the community. While each individual school will have unique concerns and goals for developing a SR2S program, an organizational strategy that promotes the sharing of ideas between schools can be more effective than several isolated school groups. The key components of an effective SR2S program include champions (individuals at each school who spearhead their school's organizing effort), stakeholders (a team of people from an individual school), and a task force made up of all the stakeholder teams in the community.

The basic components of the proposed SR2S program include bicycle/pedestrian safety education, encouragement, engineering improvements, and enforcement of traffic laws.

## Education

Curriculum programs implemented in schools can teach children the basics regarding pedestrian and bicycle safety. Classroom educational materials should be presented in a variety of formats (safety videos, printed materials, and



classroom activities), and should continually be updated to make use of the most recent educational tools available. Classroom education programs should also be expanded to promote the health and environmental benefits of bicycling and walking. Outside schools, educational materials should be developed for different audiences, including elected officials (describing the benefits of and need for a SR2S program), and parents (proper school drop-off procedures and safety for their children).

Educational programs should be linked with events and incentive programs when appropriate, and students should be included in task force activities, such as mapping locations for improvements. Involving students can serve as an educational tool and can also provide the task force with meaningful data that is useful for prioritizing improvement locations. Educational programs, and especially on-bike training, should be expanded to more schools and for more hours per year.

### **Encouragement**

School commute events and frequent commuter contests are used to encourage participation. Programs that may be implemented include a "Walking School Bus Program," which involves parents taking turns walking (or bicycling) with groups of children to school. A good opportunity to kick-off a SR2S program is during International Walk to School Day, held annually in early October. Good resources and start-up material can be found at the City of Portland's new Safe Routes to School website, <http://www.trans.ci.portland.or.us/saferoutes/program/>. Organized Bike and Walk to School Days should be held monthly or weekly to keep the momentum going and encourage more children and their parents to walk or bike to school. Prizes or drawings for prizes offered to participants have been used in some schools as an incentive. Events related to bicycling and walking should be incorporated into existing curricula when practical. Involving local celebrities or publishing the names of student participants in events can be effective means of encouraging student involvement. Another key to successful events is promotion. Ensuring that parents are aware of events (whether classroom-specific or district-wide) is crucial to gaining maximum student participation.

Other contests and event ideas to encourage bicycling and walking to school include: competitions in which classrooms compete for the highest proportion of students walking or biking to school, themed or seasonal events, and keeping classroom logs of the number of miles biked and walked by children and plotting these distances on a map of Oregon or the U.S. A wealth of information and ideas for promoting SR2S programs can be found at: [www.nhtsa.dot.gov/people/injury/pedbimot/ped/saferouteshtml/index.html](http://www.nhtsa.dot.gov/people/injury/pedbimot/ped/saferouteshtml/index.html).

### **Enforcement**

Various techniques are employed to ensure traffic laws are obeyed. The SR2S task force and stakeholder teams should develop priority areas in need of enforcement by the Newport Police Department. One option to avoid the cost of providing physical police presence is to use innovative signage, such as in-roadway crosswalk signs or in-roadway warning lights, to alert motorists that children may be crossing, or speed feedback signs that indicate to motorists their current speed.



In-class training



On-bike training



Neighborhood speed watch programs, in which community members borrow a radar device and use it to record the license plate numbers of speeding vehicles, can also be effective.

### **Engineering**

To provide safe access for children, school sites should have designated pedestrian access points that do not require students to cross in front of drop-off and pickup traffic. Locations identified through the SR2S process should be considered for SR2S grant funding.

Streetscape improvements should ensure adequate sight distance on all access routes, crossings, and intersections. School zone designations for speed limits should be an element of a comprehensive circulation plan that also includes school-based student as well as Police Department crossing guard programs and identification of safe routes for bicycling and walking to school.

### **Funding**

While much of the initial work involved in starting a SR2S program can be conducted by stakeholder team volunteers, eventually funding will be needed to plan and implement physical improvements, hold events, and develop and implement educational programs and materials.

### **Capital Funding**

Capital funding for infrastructure improvements is available from a variety of sources. The SR2S task force should work with City staff to identify all potential funding sources and to provide support on funding requests. Newport may be able to pursue federal funds recently made available with the new Safe Routes to School Program established in the Safe, Accountable, Flexible, Efficient Transportation Equity Act - A Legacy for Users (SAFTEA-LU). This section of the bill provides \$612 million in funding over the next five years with no state receiving less than \$1 million per fiscal year. Other portions of SAFTEA-LU, such as the Transportation Enhancements (TE) and the Congestion Mitigation and Air Quality (CMAQ) funds may also provide funding opportunities for bicycle and pedestrian projects.

### **Program Funding**

As Newport's SR2S program develops, funding will be needed to support the overall program, including coordination assistance, purchasing incentives, printing newsletters, staffing events, and developing educational materials. Both school-based and program-based funding will be essential for success. When program funding is pursued, it should be emphasized that a SR2S program improves the entire community by relieving traffic congestion, contributing to cleaner air, creating alternative transportation routes, and improving the health and safety of children and the entire community. In order to maintain and expand the program, new sources of funding need to be obtained. Other possible funding sources include:

- **Corporations and Businesses:** Local corporations and businesses may be able to provide cash, prizes, and/or donations, such as printing services, through community giving or other programs. Parents or other members of stakeholder teams may be a good source for contacting companies.
- **Foundations:** There are institutions throughout the country that provide funding to non-profit organizations. The Foundation Center is a national organization dedicated to collecting and communicating information about philanthropy in the U.S., and is an excellent source for researching potential foundation funding sources. Potential foundation funding sources can be searched by geographic region and by category. Some categories that may be applicable include transportation, health, environment, and community building.



- **Individuals:** Statistically, individuals give more money than corporations and foundations combined. A local fund drive can quickly reach a large number of people if outreach is conducted by stakeholder team members.
- **Events:** Many SR2S programs have raised funds by holding special events, often using a related themed event such as a walkathon or a bicycling event. More traditional fundraising efforts, such as bake sales, concerts, talent shows, etc., can also help raise funds.
- **Parent Teacher Associations (PTAs) and School Districts:** Many PTAs have funds to distribute to school programs, and often schools have their own safety funding sources. Stakeholder teams should work with local PTAs and school districts to see if there is a method for applying for a grant.
- **City and County Funds:** Some cities and counties allocate funds to support SR2S programs. Some also allocate a portion of their local Transportation Enhancement funds to SR2S educational programs.
- **State Funds:** Each state receives Federal Highway Safety Funds, also called 402 Funds. Although each state handles this program differently, most funding is available on a competitive basis for projects that increase road safety.

## Bicycle Parking

Lack of secure, convenient bicycle parking is a deterrent to bicycle travel. Bicyclists need parking options that can provide security against theft, vandalism, and weather. Like automobile parking, bicycle parking is most effective when it is located close to trip destinations, is easy to access, and is easy to find. Where quality bicycle parking facilities are not provided, determined bicyclists lock their bicycles to street signs, utility poles or trees. These alternatives are undesirable as they are usually not secure, may interfere with pedestrian movement, and can create liability or damage street furniture or trees. Bicycle parking facilities that are conveniently located and adequate in both quantity and quality can help reduce bicycle theft and eliminate inappropriate parking, benefiting everyone. Bicycle parking is highly cost-effective compared with automobile parking.

The City might undertake a bicycle parking analysis to determine whether all of the bicycle parking recommended by the Oregon Bicycle and Pedestrian Plan is being provided, and if so, that it is being provided in locations that are visible and free of obstacles. Recommendations for the type and placement of bicycle parking facilities are presented in the Design Guidelines section.

## Bicycle/Pedestrian Access to Transit

The Lincoln County Transit system provides great opportunities for increasing pedestrian/bicycle-transit partnerships in Newport and throughout Lincoln County Transit's service area. Improvements to the pedestrian environment around transit stops and transit centers increases pedestrian safety, comfort, and may generate more ridership since most passengers start and end their trips as pedestrians. Integrating bicycles with transit allows the bicyclist to overcome barriers such as hills, inclement weather, night riding, and breakdowns. To improve the pedestrian/bicycle-transit link, Newport and Lincoln County Transit need to:

- Complete the sidewalk network on both sides of the roadway along the Newport/Yachats, Newport/Lincoln City and Newport/Siletz and Toledo bus routes to ensure connectivity and accessibility for all users. This can be accomplished as new development or redevelopment occurs, or as part of a Sidewalk Infill Program.



- Provide benches, shelters, lighting, posted maps and schedules and other amenities at transit stops;
- Provide secure bicycle parking at or near transit stops;
- Address the needs of bicycle and pedestrian circulation in the design of future transit centers; and
- Ensure that bicycles are always allowed on buses

### Providing Good Sidewalks and Bikeways to Transit Stops

Improvements to the pedestrian environment around transit stops increases pedestrian safety, comfort, and may generate more transit ridership since most transit trips include a pedestrian trip at one or both ends. Most streets along the bus routes have sidewalks on both sides, though some streets have sidewalks on one side only or no sidewalks at all. Furthermore, sidewalks on several streets are in substandard condition (e.g., cracked or in disrepair).

Newport’s bikeway network should also provide good access to transit. Most streets along the shuttle route are suitable for bicycle travel either through low-volume streets or the provision of bicycle lanes on higher-volume roads.

The Design Guidelines section provides further recommendations for the design of transit stop amenities.

### Providing Secure Bicycle Parking

Long-term bicycle parking facilities (e.g., lockers) may be the most appropriate parking provision along the various Newport bus routes. “BikeStations” may also be appropriate in “higher-activity” areas like Nye Beach and the Bay Front.

BikeStations are public/private community support facilities designed to encourage bicycling and transit use by providing:

- Secure, valet bicycle parking
- Transit amenities and services
- Close connections to transit

BikeStations may also provide other amenities such as:

- Bicycle accessory retail sales
- Bicycle rentals
- Restrooms/changing facilities
- Electric bicycles
- Safety/education information



San Jose, CA BikeStation™

Depending on specific design and location parameters, BikeStations can cost several hundred thousand dollars to build and operate. However, costs can be significantly reduced by utilizing existing buildings or covered structures. Opportunities to develop BikeStations could arise with new development or redevelopment in high-activity areas.



## Alternative Transportation Coordinator

The City of Newport should consider creating an Alternative Transportation Coordinator full- or part-time position. This position would oversee implementation of the various related plans, such as the Pedestrian and Bicycle Plan. The position would also coordinate with other City departments (e.g., Public Works and Planning) and other organizations (e.g., Lincoln County Transit) to ensure that the needs of bicyclists and pedestrians are being considered in all new projects and relevant programs.

Along with a coordinator, the City should continue the successful Bicycle and Pedestrian Advisory Committee that meets regularly to identify and discuss the needs of bicyclists and pedestrians within the City of Newport.

## Wayfinding/Signing Program

The ability to navigate through a town or city is informed by landmarks, natural features, and other visual cues. A signage system is a key component of a navigable environment and would inform pedestrians, bicyclists, and motorists, while also enhancing the identity of Newport. An effective wayfinding system communicates information clearly and concisely. Placing signs throughout the city indicating to bicyclists and pedestrians their direction of travel, location of destinations, and the time/distance to those destinations will increase users' comfort and accessibility to the bicycle and pedestrian system. Costing between \$100 -\$200 dollars each, wayfinding signs are a relatively cost-effective means for improving the walking and bicycling environment.

## Spot Improvement Program

Having the ability to respond quickly to the requests of bicyclists and pedestrians will enhance Newport's standing as a bicycle- and pedestrian-friendly community. A Spot Improvement Program could be funded once a year, with all funds dedicated to smaller spot improvements identified by City staff and residents. Such improvements might include:

- Striping and signing of a particular path to increase safety and path user compliance along a heavily-used path
- Adding bicycle parking to locations that currently lack appropriate or insufficient parking, such as areas in the Bay Front
- Sidewalk infill to safely connect vital pedestrian routes, especially in school areas
- Adding appropriate directional and informational signage along paths, sidewalks, and bicycle routes
- Re-striping of bicycle lanes or crosswalks where the striping has worn away
- ADA improvements in parks

## Becoming a Bicycle Friendly Community

The Bicycle Friendly Community (BFC) Campaign is a national awards program that recognizes municipalities that actively support bicycling. A Bicycle-Friendly Community provides safe accommodations for cycling and encourages its residents to bike for transportation and recreation. The Bicycle Friendly Community Campaign is administered by the League of



American Bicyclists, an education and advocacy organization working to bring better cycling to communities around the country. The BFC designation is awarded at one of four levels (from lowest to highest): bronze, silver, gold, and platinum. To date, there have been no platinum designations awarded. In Oregon, five communities have been designated Bicycle Friendly Communities: Portland (Gold), Corvallis (Gold), Eugene (Silver), Ashland (Bronze) and Beaverton (Bronze).

### What Does it Take?

Determining whether a community is bicycle-friendly involves considering many factors and conditions. The application is an audit of a community's efforts to provide a more bicycle-friendly environment. The audit reviews engineering, education, encouragement, enforcement, and evaluation and planning efforts for bicycling. The entire application and feedback from cyclists in the community is sought to determine whether the League will award the BFC designation. The application is available online at <http://www.bicyclefriendlycommunity.org/apply.cfm>.<sup>24</sup> The BFC campaign effort can be initiated by anyone; however, the application process requires information that only the City and City staff would possess, and requires the enthusiastic support of Newport.

### Strategies

There are a number of short- and long-term steps Newport can take to become a "Bicycle Friendly Community." The City should first commit to becoming a BFC. The League of American Bicyclists provides an "Action Plan for Bicycle Friendly Communities," which identifies ten specific steps that the community should take to improve bicycling conditions. The City should then adopt the Action Plan publicly with the full backing of the Mayor and City Council.

### Action Plan for Bicycle-Friendly Communities

1. Adopt a target level of bicycle use (e.g., percent of trips) and safety to be achieved within a specific time frame, and improve data collection necessary to monitor progress.
2. Provide safe and convenient bicycle access to all parts of the community through a signed network of on- and off-street facilities, low-speed streets, and secure parking. Local cyclists should be involved in identifying maintenance needs and on-going improvements.
3. Establish information programs to promote bicycling for all purposes, and to communicate the many benefits of bicycling to residents and businesses (e.g., with bicycle maps, public relations campaigns, neighborhood rides, a ride with the Mayor).
4. Make the City a model employer by encouraging bicycle use among its employees (e.g., by providing parking, showers and lockers, and establishing a city bicycle fleet).
5. Ensure all city policies, plans, codes, and programs are updated and implemented to take advantage of every opportunity to create a more bicycle-friendly community. Staff in all departments should be offered training to better enable them to complete this task.
6. Educate all road users to share the road and interact safely. Road design and education programs should combine to increase the confidence of bicyclists.





7. Enforce traffic laws to improve the safety and comfort of all road users, with a particular focus on behaviors and attitudes that cause motor vehicle/bicycle crashes. Bicyclists should be educated to always ride in the direction of vehicle traffic.
8. Develop special programs to encourage bicycle use in communities where significant segments of the population do not drive and where short trips are most common, such as the Safe Routes to School program discussed earlier in this chapter.
9. Promote intermodal travel between Community Transit and bicycles (e.g., by installing bicycle racks on buses, improving parking at transit stops, and improving bicycle access to transit stops).
10. Establish a citywide, multi-disciplinary committee for non-motorized mobility to submit to the Mayor/Council a regular evaluation and action plan for completing the items in this action plan.

The City should educate community members and City staff on how to become more bicycle-friendly. This could entail holding a workshop or other public forum to introduce community leaders to the basic elements of a BFC. The City should also work with Oregon's Bicycle Transportation Alliance and Safe Routes to School programs to further the education effort.

Finally, the City should implement the Action Plan. Once the Action Plan has been adopted, the City needs to ensure that the Plan is implemented, and prepare and submit its BFC application.

## Sidewalk Infill Program

It is a major objective of this Plan to expand sidewalks in order to increase walking for transportation and recreation, and to overcome gaps in sidewalks that inhibit walking. The very qualities that make Newport unique and livable are inextricably linked to its pedestrian-friendliness. The City also recognizes the intrinsic health, safety, economic, and environmental benefits of improving pedestrian facilities and the level of walking.

Completing some sidewalk links can be challenging, especially in older residential areas where residents have developed fencing and landscaping within the public right-of-way and may consider those areas to be part of their personal space, or where topographic constraints exist. In addition, some residents may not want traditional sidewalks due to the rural look of their neighborhoods, and potential impacts to mature landscaping and trees. Regardless, the public right-of way that is generally located on either side of the paved driving and parking area is intended for walking, whether or not a sidewalk currently exists.

Newport should develop a Sidewalk Infill Program where City staff periodically inventory the street network to identify sidewalk gaps, and develop strategies, project prioritization criteria and funding for completing these gaps. Potential project prioritization criteria include filling gaps along key pedestrian routes, near major pedestrian trip generators like schools, and along streets with high vehicle volumes.

## Potential Implementation Process

In order to inform adjacent property owners of plans to construct a sidewalk in the public right-of-way, the Public Works Department could conduct extensive public outreach. The outreach could include of the following steps:



At the beginning of design, City staff would send a notification letter to all residents on the block face (owner and resident) on blocks that would have sidewalk infill construction on either side of the street. The letter would notify them that their location has been chosen for the Sidewalk Infill Program, that design has started, and to contact Public Works with any questions about the program.

City staff would send a notification postcard to the resident list at 50 percent design completion. This would allow the design to be far enough along to answer specific questions on a location-by-location basis, but still allow changes to the design as appropriate before finalizing the design. City staff would meet with any residents who contact the City regarding design/construction details, and they would refer any questions about the general Sidewalk Infill Program to the Public Works Department.

When design is complete and the project goes out to bid, City staff would send a third notification postcard to the resident list informing them that the project is out to bid. Council would award the construction contract and receive a map of all locations where sidewalks are to be constructed. When construction contracts are approved by Council, City staff would send a 4th notification postcard to the resident list informing them that Council has approved the construction contract and the anticipated construction schedule, and that the residents would receive a door hanger notice at least 72 hours before construction begins at their particular location.

## Accommodating People with Disabilities

With the advent of the Americans with Disabilities Act (ADA) in 1990, the nation recognized the need to provide equal access to all residents. Since its inception, ADA has significantly changed the design requirements for the construction of public space. However, much of the pedestrian environment built prior to the ADA's inception does not adequately accommodate people with disabilities. The City of Newport's approach is to gradually change this situation through land development project requirements, unrelated capital street improvement projects, and capital projects that specifically retrofit antiquated public pedestrian facilities.

It is important to note that a pedestrian environment that is strategically built to be accessible for people with disabilities is also more accessible for all. Curb ramps, for instance, can accommodate strollers, shopping carts and dollies for the movement of goods. Accessible intersection crossings can increase the safety for people regardless of ability. In recognition of this, the City's philosophical approach is to create pedestrian environments that are attractive, functional, and accessible to all people.

### Developing an ADA Transition Plan

As a part of the implementation of ADA, the Justice Department requires that all municipal jurisdictions have an ADA Transition Plan, which is intended to spell out the City's intentional retrofitting of its built environment to an accessible state.

While the elements of the Pedestrian and Bicycle Plan are purposely written to accommodate people with disabilities, a separate document with greater specificity is required. The ADA Transition Plan should use all the relevant strategies of this document as well as other current practices that have merit. Monies set aside to implement the ADA Transition Plan should be focused to accomplish the priorities of the Plan, rather than diverting them to ADA compliance in an unrelated project.

In order to adequately plan the pedestrian environment for people with disabilities, the ADA Transition Plan must take into account each of the disabilities and the limitations they present. It is also important to be aware of how planning for people



with one disability affects people with another. For example, gradual ramps and smooth transitions to the street help people in wheelchairs, but present challenges for the sight-impaired if they cannot easily find the end of the sidewalk and beginning of the street. Additionally, the Plan should also consider the needs of children and older adults.

The section below identifies populations whose needs must be taken into account in creating an accessible pedestrian environment.

### **People with Mobility Impairments**

People with mobility impairments range from those who use wheelchairs, crutches, canes, orthotics, and prosthetic devices, to those who do not use such devices but face constraints for many reasons when walking long distances, on non-level surfaces, or on steep grades. Curb ramps are particularly important to people with mobility impairments. Prosthesis users often move slowly and often have difficulty with steep grades or cross slopes.

People with mobility impairments are affected by:

- Uneven surfaces that hinder movement or cause loss of balance
- Rough surfaces that make rolling difficult, cause a loss of balance, or cause pain especially for people with back injuries
- Steep uphill slopes that can make movement slow or impossible
- Steep downhill slopes that can cause a loss of control or are difficult to negotiate
- Cross slopes that cause instability or loss of balance
- Narrow sidewalks that impede the ability of users to turn or to cross paths with others
- Devices that are hard to reach, such as push buttons for walk signals and doors
- Long distances
- Situations that require fast reaction time
- Signalized walk phases that are shorter than the time it takes for them to cross the street

### **People with Sensory Impairments**

People with sensory impairments include those who are partially or fully blind or deaf. They also include people whose perception of touch or balance is not good, as well as those who are colorblind.

Visually-impaired people have the following characteristics:

- Limited or no perception of the path ahead
- Limited or no information about their surroundings, especially in a new place
- Changing environments in which they rely on memory
- Lack of non-visual information
- Inability to react quickly



- Unpredictable situations, such as complex intersections that are not at 90 degrees
- Inability to distinguish the edge of the sidewalk from the street
- Compromised ability to detect the proper time to cross a street
- Compromised ability to cross a street along the correct path (especially when a curb ramp is oriented diagonally toward an intersection's center point)
- Need for more time to cross the street

Hearing impaired people rely on visual information, which is often inadequate. They face most of their mobility difficulties in not being able to hear approaching vehicles and not being able to detect the time of their arrival. This is especially an issue in locations with limited sight distances, such as where streets curve or landscaping blocks the view.

### **People with Cognitive Impairments**

People with cognitive impairments encounter difficulties in thinking, learning, responding, and performing coordinated motor skills. Cognitive disabilities can cause some to become lost, or to have difficulty finding their way. They may also not understand standard street signage. People who are not able to read benefit from signs with symbols and colors.

### **Children and Other Adults**

Children and many older adults do not fall under specific categories for disabilities, but must be taken into account in pedestrian planning. Children are less mentally and physically developed than adults. They have the following characteristics:

- Less peripheral vision
- Less ability to judge speed and distance
- Difficulty locating sounds
- Read less than adults or not at all, so do not understand text signs
- Sometimes act impulsively or unpredictably
- Lack familiarity with traffic
- Face difficulty carrying packages

Other adults often exhibit degrading sensory or physical capabilities. This can cause them to:

- Gradually lose vision, especially at night
- Have decreased ability to hear sounds and detect where they come from
- Have less endurance; have less strength to walk up hills
- Have less balance, especially on uneven or sloped sidewalks
- React slowly to dangerous situations
- Walk slowly



## Education Programs

### School-based Education Programs

A school-based bicycle and pedestrian education program educates students about the rules of the road, proper use of bicycle equipment, bicycling skills, street crossing skills, and the benefits of bicycling and walking. These types of education programs are usually sponsored by a joint City/school district committee that includes appointed parents, teachers, student representatives, administrators, police, active bicyclists and engineering department staff. These programs can also be rolled into a Safe Routes to School Program.

Education need not be limited to younger schoolchildren. Adult bicycle education and safety programs can be developed from existing courses, such as the League of American Bicyclists courses. Additionally, the Newport Police Department may want to utilize adult bicycle education programs as a "bicycle traffic school" in lieu of fines for bicycle-related traffic violations.

### Safety Handbook

Safety handbooks are generally developed as part of a school-based bicycle and pedestrian safety program. Handbooks may include a circulation map of the campus and immediate neighborhood showing the preferred circulation and parking patterns, suggested routes to school, locations of crosswalks, crossing guards and signalized intersections, instructions for bicycle maintenance and use, instructions for fitting and wearing a helmet, instructions for crossing the street, and lists of emergency and school numbers. A general handbook can be published by the City and used by each school in conjunction with the school-specific map.

### Educate Motorists, City Staff, Maintenance, and Construction Crews

Motorist education on the rights of bicyclists and pedestrians is limited. Many motorists mistakenly believe, for example, that bicyclists do not have a right to ride in travel lanes and that they should be riding on sidewalks. Education about the rights and responsibilities of pedestrians and cyclists can include:

- Incorporating bicycle and pedestrian safety into traffic school curriculum.
- Producing a brochure on bicycle and pedestrian safety and laws for public distribution.
- Enforcing traffic laws for cyclists.
- Providing bicycle and pedestrian planning training for all City planners.
- Working with contractors, subcontractors and city maintenance and utility crews to ensure they understand the needs of bicyclists and pedestrians and follow standard procedures when working on or adjacent to roadways and walkways.



## **Bicycle Patrol Unit**

The City of Newport may want to work with the Police Department, local business and neighborhood groups to establish local Bicycle Patrol Units. A Bicycle Patrol Unit may be an official law enforcement unit, a private security guard patrol, or a volunteer network. Bicycles are an excellent community policing tool, as officers on bikes are often viewed as more approachable, thus improving trust and relations between the citizens and police. Bicycle patrol units can work closely with citizens to address concerns before they become problems. Bicycle patrol units can have a direct impact on bicycle safety by enforcing bicycle traffic laws (e.g., wrong-way riding, sidewalk riding, obeying traffic controls, children wearing helmets), and providing bicycle safety education.

## **Encouragement Programs**

Strategies for community involvement in bicycle and pedestrian improvements will be important to ensure broad-based support – which translates into political support – to help secure financial resources. Involvement by the private sector in raising awareness of the benefits of bicycling can range from small incremental activities by non-profit groups, to efforts by the largest employers in the City. Specific programs are described below.

### **Facilitate the Development of Employer Incentive Programs**

Employer incentive programs to encourage employees to walk and bike to work include strategies like providing bicycle lockers and shower facilities, offering more flexible arrival and departure times, and fun incentives such as entry into monthly raffle contests. The City may offer incentives to employers to institute these improvements through air quality credits, lowered parking requirements, reduced traffic mitigation fees, or other means.

### **Community Bikeway/Walkway Adoption**

Community Bikeway/Walkway Adoption programs are similar to the widely-instituted Adopt-a-Highway programs throughout the country. These programs identify local individuals, organizations, or businesses that would be interested in “adopting” a bikeway or walkway. Adopting a facility would mean that person or group would be responsible for the facility’s maintenance either through direct action or as the source of funding for the City’s maintenance of that facility. For example, members of a local recreation group may volunteer every other weekend to sweep a bikeway and identify and address larger maintenance needs. Or, a local bike shop may adopt a bikeway by providing funding for the maintenance costs. The managers of an adopted bikeway may be allowed to post their name on bikeway signs throughout the bikeway in order to display their commitment to bicycling in Newport.

### **Create a Multi-Modal Access Guide**

A multi-modal access guide provides concise customized information on how to access specific destinations with emphasis on bicycling, walking and transit. Access guides can be as simple as a map printed on the back of a business card or as complex as a multi-page packet distributed to employees. Some items commonly included in access guides are:

- A map of the area depicting bus stops, recommended walking and bicycling routes, landmarks, facilities such as restrooms and drinking fountains, locations of bicycle and vehicle parking, and major roads
- Information on transit service, including frequency, fares, accepted methods of payment, first and last runs, schedules, phone numbers and websites of transit service providers and taxis



- Information on how long it takes to walk or bike from a transit center to a destination
- Accessibility information for people with disabilities

Best practices include using graphics, providing specific step-by-step travel directions, providing parking location and pricing information, and providing information about the benefits of walking and bicycling. High quality access guides should be concise and accurate and should incorporate input from key stakeholders, including public transportation operators, public officials, employees, staff who will be distributing the access guide, and those with disabilities.

### **Work with Businesses to Develop Incentives for Bicycling and Walking**

Incentive programs to encourage bicycling and walking to local businesses can be developed in coordination with individual businesses, the Chamber of Commerce, and the Bicycle Transportation Alliance. Such efforts may include:

- Creating promotional events such as “Bicycle to the Grocery Store” days, when cyclists get vouchers for, or discounts on items in the store, or “bicycle to the video store” days, when cyclists receive free popcorn or a discount on a movie rental.
- Holding an annual community event to encourage residents to replace one car trip a week with a bicycle trip. This type of event could be integrated with current special events like “Celebrate Newport.”
- Developing, promoting and publicizing bicycle commuter services, such as bike shops selling commute gear, bikes-on-transit policies, and regular escorted commute rides.
- Creating an annual commuter challenge for area businesses.



### Walk- and Bike-to-School Days

The City and School District should encourage residents to participate in the annual international Walk-to-School Day held each October. The City and School District could also create a Bike-to-School day. These events raise the profile of bicycling and walking among children. Local Bike- and Walk-to-Work days can be held annually in conjunction with the school-related events.



### Bike Fairs, Organized Rides, and Races

Hosting bike fairs, organized rides (such as Cycle Oregon), and races in Newport can raise the profile of bicycling in the area and provide entertainment for all ages at the same time. Bike fairs and races provide an opportunity to educate and encourage current and potential bicyclists. These events can also bring visitors to Newport that may also contribute to the local economy. These events could be sponsored and implemented through collaboration between the City and local employers.

### TravelSmart Programs

TravelSmart is an innovative way to encourage environmentally-friendly ways to travel. The concept, used in more than 300 projects around the world, identifies individuals who want to change the way they travel and uses personal, individualized contact to motivate them to think about their travel options. TravelSmart provides customized information and training to help people take transit, bike, walk or carpool for some of their trips. TravelSmart projects provide many benefits including individual health and financial improvements, and community-wide benefits such as reduced air pollution and enhanced community safety.

TravelSmart gives participants just the information they ask for to help them get started, or to keep on walking, biking, taking transit or carpooling. Those who do not want information are left alone. Materials are delivered by a “Travel Ambassador” in the most efficient and cost effective way – by bicycle. Travel Ambassadors are cross-trained to answer participants’ questions concerning all alternative travel modes. Depending on the information requested by an individual participant, marketing materials could include maps identifying safe, convenient and direct walking and bicycling routes in Newport, public bicycle parking locations, Lincoln County Transit maps and schedules, and free bus passes. Travel Ambassadors would contact program participants periodically to answer questions about alternative transportation. The City could also periodically survey participants about their travel habits to gauge the program’s success.

### Enforcement Programs

The best protection for pedestrians and bicyclists traveling along and across streets are motorists who are aware of and follow laws regarding bicycle/pedestrian right-of-way. Many people however are unaware of these laws.

Targeted enforcement action should be focused in those areas with high bicycle and pedestrian volumes or where non-motorized travelers are especially vulnerable. Law enforcement efforts should be targeted during periods and at locations where motorists and the general public will become aware of bicycle/pedestrian laws and their penalties. It is recommended that such targeted enforcement occur at least four times per year and last one week. Focused enforcement should also take place at the start of the school year at selected schools near their primary access points by children walking and cycling. An





effective form of targeted enforcement is the use of a Police Officer posing as a pedestrian crossing the street. Motorists who do not yield to the officer are ticketed by other Police Officers further down the street. Another example of effective enforcement of the bicycle and pedestrian right-of-way is ticketing cars parked across the sidewalk or within striped bicycle lanes.

All targeted enforcement actions should be coordinated with the Public Works Department. The Newport Police Department should also be surveyed for input on appropriate educational material, advisory and warning signs, and other tools to help them accomplish their mission. Finally, it is recommended that the Police Department vigorously pursue legal action against motorists who cause a bicycle/pedestrian injury or fatality.

Pedestrians and bicyclists are protected in the public right-of-way by the Oregon Vehicle Code, as enforced by the Newport Police Department. Some of the key provisions of the Oregon Vehicle Code pertaining to pedestrians and bicyclists are shown below.

**811.015 Failure to obey traffic patrol member; penalty.**

(1) The driver of a vehicle commits the offense of failure to obey a traffic patrol member if:

(a) A traffic patrol member makes a cautionary sign or signal to indicate that students have entered or are about to enter the crosswalk under the traffic patrol member's direction; and

(b) The driver does not stop and remain stopped for students who are in or entering the crosswalk from either direction on the street on which the driver is operating.

(2) Traffic patrol members described in this section are those provided under ORS 339.650 to 339.665.

(3) The offense described in this section, failure to obey a traffic patrol member, is a Class A traffic violation. [1983 c.338 §545; 1995 c.383 §12; 2003 c.278 §2]

**811.020 Passing stopped vehicle at crosswalk; penalty.**

(1) The driver of a vehicle commits the offense of passing a stopped vehicle at a crosswalk if the driver:

(a) Approaches from the rear another vehicle that is stopped at a marked or an unmarked crosswalk at an intersection to permit a pedestrian to cross the roadway; and

(b) Overtakes and passes the stopped vehicle.

(2) The offense described in this section, passing a stopped vehicle at a crosswalk, is a Class B traffic violation. [1983 c.338 §546]

**811.025 Failure to yield to pedestrian on sidewalk; penalty.**

(1) The driver of a vehicle commits the offense of failure to yield to a pedestrian on a sidewalk if the driver does not yield the right of way to any pedestrian on a sidewalk.



(2) The offense described in this section, failure to yield to a pedestrian on a sidewalk, is a Class B traffic violation. [1983 c.338 §547; 1995 c.383 §42]

**811.028 Failure to stop and remain stopped for pedestrian; penalty.**

(1) The driver of a vehicle commits the offense of failure to stop and remain stopped for a pedestrian if the driver does not stop and remain stopped for a pedestrian when the pedestrian is:

(a) Proceeding in accordance with a traffic control device as provided under ORS 814.010 or crossing the roadway in a crosswalk, as defined in ORS 801.220; and

(b) In any of the following locations:

(A) In the lane in which the driver's vehicle is traveling;

(B) In a lane adjacent to the lane in which the driver's vehicle is traveling;

(C) In the lane into which the driver's vehicle is turning;

(D) In a lane adjacent to the lane into which the driver's vehicle is turning, if the driver is making a turn at an intersection that does not have a traffic control device under which a pedestrian may proceed as provided under ORS 814.010; or

(E) Less than six feet from the lane into which the driver's vehicle is turning, if the driver is making a turn at an intersection that has a traffic control device under which a pedestrian may proceed as provided under ORS 814.010.

(2) For the purpose of this section, a bicycle lane or the part of a roadway where a vehicle stops, stands or parks that is adjacent to a lane of travel is considered to be part of that adjacent lane of travel.

(3) This section does not require a driver to stop and remain stopped for a pedestrian under any of the following circumstances:

(a) Upon a roadway with a safety island, if the driver is proceeding along the half of the roadway on the far side of the safety island from the pedestrian; or

(b) Where a pedestrian tunnel or overhead crossing has been provided at or near a crosswalk.

(4) The offense described in this section, failure to stop and remain stopped for a pedestrian, is a Class B traffic violation. [2005 c.746 §2]

**811.035 Failure to stop and remain stopped for blind pedestrian; penalty.**

(1) The driver of a vehicle commits the offense of failure to stop and remain stopped for a blind pedestrian if the driver violates any of the following:



(a) A driver approaching a blind or blind and deaf pedestrian carrying a white cane or accompanied by a dog guide, who is crossing or about to cross a roadway, shall stop and remain stopped until the pedestrian has crossed the roadway.

(b) Where the movement of vehicular traffic is regulated by traffic control devices, a driver approaching a blind or blind and deaf pedestrian shall stop and remain stopped until the pedestrian has vacated the roadway if the blind or blind and deaf pedestrian has entered the roadway and is carrying a white cane or is accompanied by a dog guide. This paragraph applies notwithstanding any other provisions of the vehicle code relating to traffic control devices.

(2) This section is subject to the provisions and definitions relating to the rights of pedestrians who are blind or blind and deaf under ORS 814.110.

(3) The offense described in this section, failure to stop and remain stopped for a blind pedestrian, is a Class B traffic violation. [1983 c.338 §549; 1985 c.16 §280; 2003 c.278 §3]

**811.050 Failure to yield to rider on bicycle lane; penalty.**

(1) A person commits the offense of failure of a motor vehicle operator to yield to a rider on a bicycle lane if the person is operating a motor vehicle and the person does not yield the right of way to a person operating a bicycle, electric assisted bicycle, electric personal assistive mobility device, moped, motor assisted scooter or motorized wheelchair upon a bicycle lane.

(2) This section does not require a person operating a moped to yield the right of way to a bicycle or a motor assisted scooter if the moped is operated on a bicycle lane in the manner permitted under ORS 811.440.

(3) The offense described in this section, failure of a motor vehicle operator to yield to a rider on a bicycle lane, is a Class B traffic violation. [1983 c.338 §698; 1985 c.16 §336; 1991 c.417 §4; 1997 c.400 §8; 2001 c.749 §23; 2003 c.341 §7]

**811.060 Vehicular assault of bicyclist or pedestrian; penalty.**

(1) For the purposes of this section, "recklessly" has the meaning given that term in ORS 161.085.

(2) A person commits the offense of vehicular assault of a bicyclist or pedestrian if:

(a) The person recklessly operates a vehicle upon a highway in a manner that results in contact between the person's vehicle and a bicycle operated by a person, a person operating a bicycle or a pedestrian; and

(b) The contact causes physical injury to the person operating a bicycle or the pedestrian.

(3) The offense described in this section, vehicular assault of a bicyclist or pedestrian, is a Class A misdemeanor. [2001 c.635 §5]

**811.435 Operation of motor vehicle on bicycle trail; exemptions; penalty.**

(1) A person commits the offense of operation of a motor vehicle on a bicycle trail if the person operates a motor vehicle upon a bicycle lane or a bicycle path.



(2) Exemptions to this section are provided under ORS 811.440.

(3) This section is not applicable to mopeds. ORS 811.440 and 814.210 control the operation and use of mopeds on bicycle lanes and paths.

(4) The offense described in this section, operation of a motor vehicle on a bicycle trail, is a Class B traffic violation. [1983 c.338 §643]

**814.400 Application of vehicle laws to bicycles.**

(1) Every person riding a bicycle upon a public way is subject to the provisions applicable to and has the same rights and duties as the driver of any other vehicle concerning operating on highways, vehicle equipment and abandoned vehicles, except:

(a) Those provisions which by their very nature can have no application.

(b) When otherwise specifically provided under the vehicle code.

(2) Subject to the provisions of subsection (1) of this section:

(a) A bicycle is a vehicle for purposes of the vehicle code; and

(b) When the term "vehicle" is used the term shall be deemed to be applicable to bicycles.

(3) The provisions of the vehicle code relating to the operation of bicycles do not relieve a bicyclist or motorist from the duty to exercise due care. [1983 c.338 §697; 1985 c.16 §335]

**811.440 When motor vehicles may operate on bicycle lane.**

This section provides exemptions from the prohibitions under ORS 811.435 and 814.210 against operating motor vehicles on bicycle lanes and paths. The following vehicles are not subject to ORS 811.435 and 814.210 under the circumstances described:

(1) A person may operate a moped on a bicycle lane that is immediately adjacent to the roadway only while the moped is being exclusively powered by human power.

(2) A person may operate a motor vehicle upon a bicycle lane when:

(a) Making a turn;

(b) Entering or leaving an alley, private road or driveway; or

(c) Required in the course of official duty.



(3) An implement of husbandry may momentarily cross into a bicycle lane to permit other vehicles to overtake and pass the implement of husbandry.

(4) A person may operate a motorized wheelchair on a bicycle lane or path.

(5) A person may operate a motor assisted scooter on a bicycle lane or path.

(6) A person may operate an electric personal assistive mobility device on a bicycle lane or path. [1983 c.338 §645; 1991 c.417 §1; 2001 c.749 §24; 2003 c.341 §8]





# Newport

## Pedestrian & Bicycle Plan



## 5. DESIGN GUIDELINES AND STANDARDS

### Introduction

This chapter discusses recommended design guidelines for Newport's pedestrian and bicycle system. Design recommendations are proposed for each of the non-motorized facility types proposed in this plan including bikeways and walkways. This chapter also discusses other important issues that should be considered as the City improves existing facilities and expands the pedestrian and bicycle network.

The design standards use the Manual on Uniform Traffic Control Devices (MUTCD) guidelines as the preferred approach with options identified that the city can implement at their discretion. ODOT will only follow the MUTCD guidelines for their facilities. The MUTCD uses highly specific language to classify the guidelines. The following terms are defined by the MUTCD:

- **Standard:** A statement of required, mandatory, or specifically prohibitive practice regarding a traffic control device.
- **Guidance:** A statement of recommended, but not mandatory, practice in typical situations, with deviations allowed if engineering judgment or engineering study indicates the deviation to be appropriate.
- **Option:** A statement of practice that is a permissive condition and carries no requirement or recommendation. Options may contain allowable modifications to a Standard or Guidance.
- **Support:** An informational statement that does not convey any degree of mandate, recommendation, authorization, prohibition or enforceable condition.

The inclusion of design guidelines and standards not included in the MUTCD does not constitute tacit approval of the recommendations by the City or State.

### Sidewalks

A variety of considerations are important in sidewalk design. Providing adequate and accessible facilities should lead to increased numbers of people walking, improved safety, and the creation of social space. Attributes of well-designed sidewalks include the following:

- **Accessibility:** A network of sidewalks should be accessible to all users and meet ADA requirements.
- **Adequate width:** Two people should be able to walk side-by-side and pass a third person comfortably and different walking speeds should be possible. In areas of intense pedestrian use, sidewalks should be wider to accommodate the greater volume of walkers.

- **Safety:** Design features of the sidewalk should allow pedestrians to have a sense of security and predictability. Sidewalk users should not feel they are at risk due to the presence of adjacent traffic.
- **Continuity:** Walking routes should be obvious and should not require pedestrians to travel out of their way unnecessarily.
- **Landscaping:** Plantings and street trees within the roadside area should contribute to the overall psychological and visual comfort of sidewalk users, without providing hiding places for attackers.
- **Social space:** Sidewalks should be more than areas to travel; they should provide places for people to interact. There should be places for standing, visiting, and sitting. The sidewalk area should be a place where adults and children can safely participate in public life.
- **Quality of place:** Sidewalks should contribute to the character of neighborhoods and business districts and strengthen their identity.

### Width

Required sidewalk widths in Newport vary based a street's ownership and functional classification. According the Highway Design Manual (HDM), ODOT requires six-foot sidewalks with four-foot planter strips on US 101, although this requirement is not often met. The City of Newport requires five-foot sidewalks on all streets.

Generally, sidewalks should be at least six feet wide, exclusive of the curb and other obstructions. This width enables two pedestrians (including wheelchair users) to walk side by side, or to pass each other comfortably. It also allows two pedestrians to pass a third pedestrian without leaving the sidewalk. This Plan recommends that the City of Newport increase its current minimum sidewalk width standard to six feet to address these issues.

### Surface

Sidewalk surfaces should be smooth and continuous. It is also desirable that the sidewalk surface be stable, firm and slip resistant. Preferred materials include Portland Cement Concrete (PCC) and Asphalt Concrete (AC). PCC provides a smooth, long-lasting and durable finish that is easy to grade and repair. AC has a shorter life expectancy but may be more appropriate in less urbanized areas and in park settings. Crushed aggregate may also be used as an all-weather walkway surface in park areas, but this material generally requires a higher level of maintenance to maintain accessibility.

Brick pavers (or other decorative treatments) may be used on some sidewalks and crosswalks if they are constructed to avoid settling or removal of bricks, which can create tripping hazards. This treatment should also be constructed to provide a high level of smoothness to accommodate wheelchairs and other mobility devices. Alternatives to brick pavers include "stamping" molds to create the visual appearance of bricks.

The Americans with Disabilities Act allows a maximum two percent cross-slope on sidewalks and other walkways. Where sidewalks meet driveways, curb cuts or intersections, a three-foot-wide area should be maintained with a two percent cross-slope.





## Addressing Obstructions

Obstructions to pedestrian travel in the sidewalk corridor typically include sign posts, utility and signal poles, mailboxes, fire hydrants and street furniture. Obstructions should be placed between the sidewalk and the roadway to create a buffer for increased pedestrian comfort while maintaining six feet of lateral clearance. When sidewalks abut perpendicular or angle on-street parking, wheelstops should be placed in the parking area to prevent parked vehicles from overhanging in the sidewalk. When sidewalks abut hedges, fences, or buildings, an additional two feet of lateral clearance should be added to provide appropriate shy distance.

Driveways represent another sidewalk obstruction, especially for wheelchair users. The following techniques can be used to accommodate wheelchair users at driveway crossings:

- Reducing the number of accesses reduces the need for special provisions. This strategy should be pursued first.
- Constructing wide sidewalks avoids excessively steep driveway slopes. The overall width must be sufficient to avoid an abrupt driveway slope.
- Planter strips allow sidewalks to remain level, with the driveway grade change occurring within the planter strip.
- Where constraints preclude a planter strip, wrapping the sidewalk around the driveway has a similar effect. However, this method may have disadvantages for visually-impaired pedestrians who follow the curb line for guidance.
- When constraints only allow curb-tight sidewalks, dipping the entire sidewalk at the driveway approaches keeps the cross-slope at a constant grade. However, this may be uncomfortable for pedestrians and could create drainage problems behind the sidewalk.

## Alternatives to Sidewalks

Although the City of Newport has a goal of providing sidewalks on both sides of all streets, physical and other constraints (especially in older neighborhoods) could preclude sidewalks in some parts of the city. Alternative sidewalk treatments could be used to accommodate foot traffic in these areas.

### Soft Paths

In areas where paved sidewalks are not feasible or appropriate due to site conditions such as existing trees, walls, or other obstacles, a soft path alternative should be explored. A soft path is a pedestrian path constructed of a pervious material

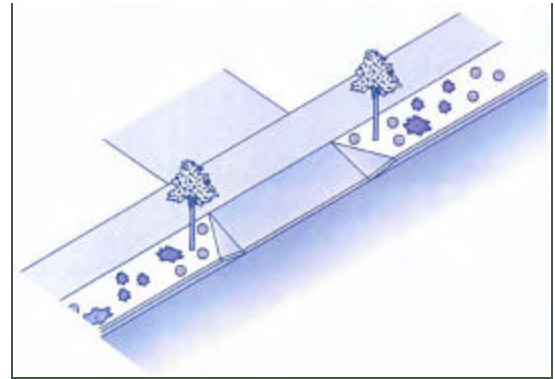

Driveway apron utilizing a planter strip

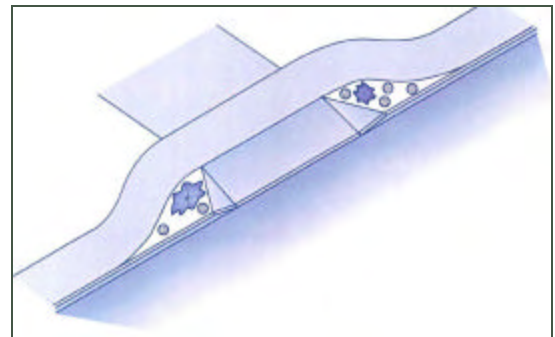

Sidewalk wrapped around driveway

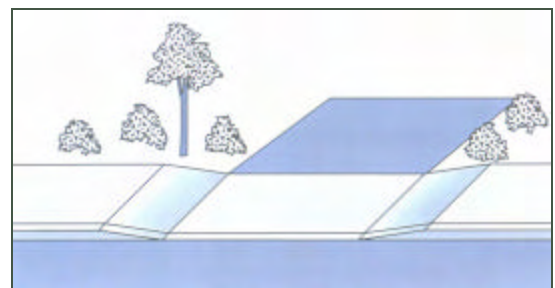

Entire sidewalk dips at driveway



such as decomposed granite or other universally accessible material. Another option is rubberized sidewalks, which use one recycled automobile tire per square foot of sidewalk. Rubberized sidewalks cost approximately one-third more than the cost of typical concrete sidewalks, but require significantly less maintenance than concrete sidewalks that are located near trees, since they can be lifted out of the ground for periodic tree root trimming. Rubberized sidewalks are less likely than concrete to be broken up by tree roots, further reducing long-term costs. Soft paths should be at least five feet wide. Constricted areas may have a reduced width consistent with the ADA guidelines.

### **Colored Shoulders**

Colored shoulders visually narrow the roadway and slow traffic, making it more pedestrian friendly. They are optional treatments for neighborhoods with no room for traditional sidewalks. Drivers see only travel lanes as available road space, so the roadway appears narrower than it is when the shoulders are a different color. Painting the road surface requires frequent maintenance; lower-maintenance methods include:

- Paving travel lanes with concrete, and bicycle/pedestrian facilities with asphalt, or the reverse
- Slurry sealing or chip-sealing the roadway, and not the pedestrian path
- Incorporating dyes into concrete or asphalt
- Colored unit pavers that resemble brick

## **Bicycle Lanes**

This Plan proposes bicycle lanes on several existing streets in Newport. The City currently requires 5-foot bicycle lanes on city streets while ODOT requires six-foot bicycle lanes on State highways. Cyclists need at least four feet of lateral clearance while operating in a bicycle lane. A lane's usable width is normally measured from the curb face to the center of the lane stripe, although adjustments should be made for drainage grates and longitudinal joints between the street pavement and the curb gutter pan. Discussed later, this Plan recommends that the City increase its current bicycle lane width standard to six feet to address these issues. If parking is permitted on a street, bicycle lanes should be placed between the parking lane and the travel lane.

Oregon Administrative Rules require bicycle lanes to be striped with an eight-inch solid white line to increase the visual separation between the vehicle lane and bicycle lane. A four-inch solid white line may also be striped between the bicycle lane and adjacent on-street parking to encourage parking closer to the curb and to provide additional separation from motor vehicles.

### **Manual on Uniform Traffic Control Devices (MUTCD) Guidelines**

Part 3 of the MUTCD covers roadway markings, while Part 9 of the MUTCD covers signs, pavement markings, and highway traffic signals specifically related to bicycle operation on both roadways and shared-use paths.

Section 3B.22 Preferential Lane Words and Symbol Marking, Section 9C.04 Markings for Bike Lanes and Section 9B.04 Bicycle Lane Signs (R3-17, R3-17a, R3-17b) provide the baseline standard for striping, marking and signing bike lanes in Newport.



**Section 3B.22 Preferential Lane Word and Symbol Markings**

The Standard states, “When a lane is assigned full or part time to a particular class or classes of vehicles, preferential lane markings shall be used. Signs or signals shall be used with preferential lane word or symbol markings. All preferential lane word and symbol markings shall be white. All preferential lane word and symbol markings shall be positioned laterally in the center of the preferred-use lane.” The standard continues by noting that, “Where a preferential lane use is established, the preferential lane shall be marked with one or more of the following symbol or word markings for the preferential lane use specified: ...Bicycle lane – the preferential lane use marking for a bicycle lane shall consist of a bicycle symbol or the work marking BIKE LANE.”

**Section 9C. 04 Markings for Bike Lanes**

The Guidance notes that. “Longitudinal pavement markings should be used to define bicycle lanes.” The standard states that, “If used, the bicycle lane symbol marking shall be placed immediately after an intersection and at other locations as needed. The bicycle lane symbol marking shall be white. If the word or symbol pavement markings are used, Bicycle Lane signs shall also be used, but the signs need not be adjacent to every symbol to avoid overuse of the signs.”

**Section 9B.04 Bicycle Lane Signs**

The standard for Bicycle Lane Signs states, “The BIKE LANE (R3-17) sign shall be used only in conjunction with marked bicycle lanes as described in Section 9C.04, and shall be placed at periodic intervals along the bicycle lanes.”

The Oregon Bicycle and Pedestrian Plan recommends placing stencils after most intersections to alert motorists and cyclists of the exclusive nature of bicycle lanes. For long street segments with few intersections, the appropriate frequency of stencils is calculated by multiplying the street’s design speed by 40. For instance, stencils should be placed every 1,400 feet on streets with a 35 MPH designated speed.

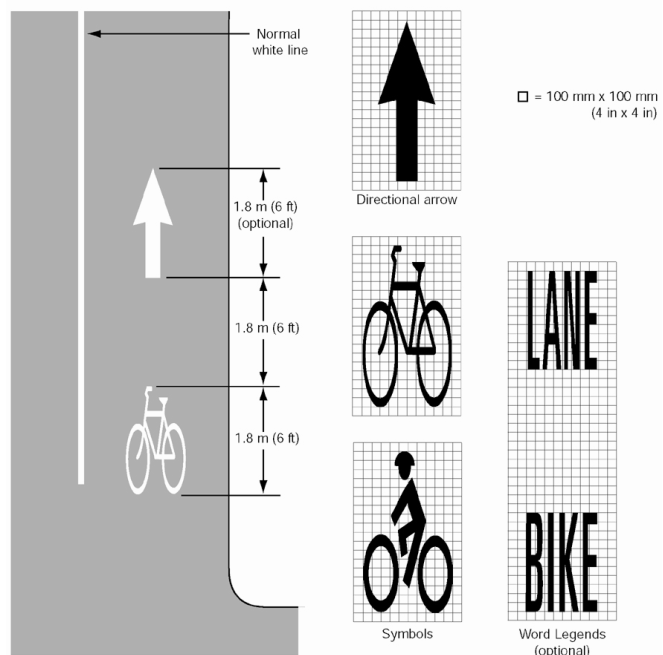

MUTCD Markings for Bike Lanes



MUTCD Bike Lane Sign R3-17



## Other Bicycle Lane Treatments

### Addressing Drainage Grates and Other Obstacles

Bicycle lanes should be provided with adequate drainage to prevent ponding, washouts, debris accumulation and other potentially hazardous situations for cyclists. Drainage grates should be bicycle-safe (See Figure 5-1). When an immediate replacement of an incompatible grate is not possible, a temporary correction of welding thin metal straps across the grates perpendicular to the drainage slots (four to six inches apart, center-to-center spacing) should be considered. Bicycle lanes should also include a smooth riding surface, and utility covers should be adjusted flush with the street surface. Furthermore, raised pavement markings (e.g., reflectors and truncated domes) can cause steering difficulties for bicyclists, and should not be used to delineate bicycle lanes.

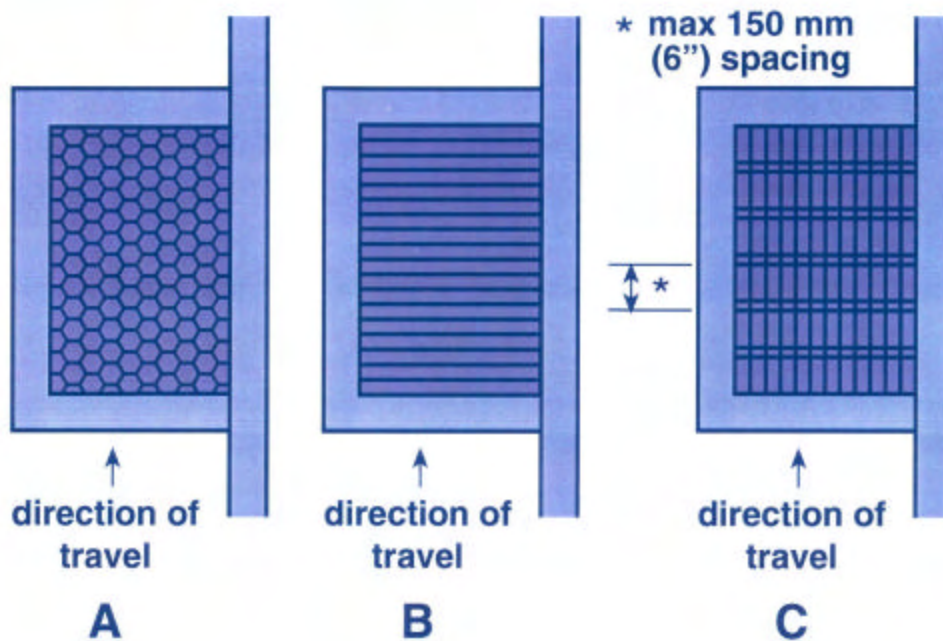

Figure 5-1. Bicycle-Safe Drainage Grates



## Shared Roadways/Bicycle Boulevards

Typically the most common type of bikeway, shared roadways are streets with relatively low traffic volumes and posted speeds that enable cyclists and motorists to share the same travel lanes. These streets usually have two travel lanes with or without adjacent on-street parking. Additional treatments, described below, vary by street.

### Bicycle Routes

The MUTCD defines a designated bicycle route as, “a system of bikeways designated by the jurisdiction having authority with appropriate directional and informational route signs, with or without specific bicycle route numbers. Bicycle routes, which might be a combination of various types of bikeways, should establish a continuous routing.”

### Bicycle Boulevards

Bicycle routes that incorporate treatments to accommodate cyclists are often called “bicycle boulevards.” Bicycle boulevards are developed through a combination of traffic calming measures and other streetscape treatments, and are intended to slow vehicle traffic while facilitating safe and convenient bicycle travel. Appropriate treatments depend on several factors including traffic volumes, vehicle and bicycle circulation patterns, street connectivity, street width, physical constraints, and other parameters. Most streets could be provided relatively inexpensive treatments like new signage, pavement markings, striping and signal improvements to facilitate bicyclists’ mobility and safety. Other potential treatments include curb extensions, medians, on-street parking delineation and other features that can be implemented at reasonable cost and are compatible with snow plowing and emergency vehicle accessibility. It should be noted that many bicycle boulevard treatments can also benefit pedestrians. Curb extensions, for instance, can reduce vehicle speeds on a street by creating a visual “pinch point” for motorists. They also improve the pedestrian environment by shortening the pedestrian crossing distance.

### Bicycle Boulevard Applications

The following section describes recommended applications for Newport’s proposed shared roadway/bicycle boulevard system. The treatments have been divided into five main categories based on their level of “intensity”, with Level 1 representing the least intensive treatments that could be implemented at relatively low cost. It should be noted that each successive application “level” would also include (where necessary) treatments identified for the previous levels. Furthermore, several treatments could fall within multiple categories as they achieve multiple goals.

#### Level 1: Signage

Bikeway signage is relatively cost-effective treatment the can improve the bicycling environment along Newport’s bicycle boulevard system. Described below, signage can serve both wayfinding and safety purposes.

#### Wayfinding Signs

Bicycle wayfinding signs should be installed along Newport’s bicycle boulevards and other cycling routes.



MUTCD Bike Route Guide Sign D11-1



**MUTCD Guidelines**

There are no Standards proscribed for wayfinding or guide signs in the MUTCD. However, there are several sections that do address wayfinding signage along bicycle routes.

*Section 9B.19 Bicycle Route Guide Signs* provides the following guidance, “If used, Bicycle Route Guide (D11-1) signs should be provided at decision points along designated bicycle routes, including signs to inform bicyclists of bicycle route direction changes and confirmation for route direction, distance, and destination. If used, Bicycle Route Guide signs should be repeated at regular intervals so that bicyclists entering from side streets will have an opportunity to know that they are on a bicycle route.

*Section 9B.20 Bicycle Route Signs* provides the Option of establishing a unique identification (route designation) for a State or local bicycle route using the Bicycle Route (M1-8) sign.

*Section 9B.21 Destination Arrow and Supplemental Plaque Signs for Bicycle Route Signs* provides the Option of mounting Destination (D1-1b and D1-1c) signs or directional arrow signs (M7-1 through M7-7) below the Bicycle Route Guide sign to furnish additional information.

**Optional Signage Design**

The City of Portland has found great success in using a slightly different bicycle route sign than identified in the MUTCD. The City of Portland sign differs in three primary ways:

- It incorporates the Bicycle Route Guide Sign, the Destination Arrow, and the Directional Arrow signs all on one sign
- It provides for the inclusion of multiple destinations on one sign
- It includes time to destination as well as distance



MUTCD Bicycle Route Sign M1-8



MUTCD Destination Sign D1-1b



MUTCD Directional Arrow Signs M7-1/7



Optional Wayfinding Signage Design



## Warning Signs

On bicycle boulevards with higher vehicle and bicycle volumes (e.g., SE Bay Blvd, NW 6<sup>th</sup> St), the City should also consider installing additional warning signs advising motorists to the presence of cyclists. This signage would also be effective in areas with higher numbers of bicycle trips, such as the Oregon Coast Bicycle Route.

### **MUTCD Guidelines**

*Section 9B.17 Bicycle Warning Sign* notes that a Bicycle Warning sign (W11-1) alerts the road user to unexpected entries into the roadway by bicyclists and other crossing activities that might cause conflicts. As an option, a supplemental plaque with the legend AHEAD or XXX FEET may be used with the Bicycle Warning sign.

*Section 9B.18 Other Bicycle Warning Signs* provides the Option for the installation of additional warning signs such as BIKEWAY NARROWS on bicycle facilities to warn bicyclists of conditions not readily apparent. In addition, in situations where there is a need to warn motorists to watch for bicyclists traveling along the highway, the SHARE THE ROAD (W16-1) plaque may be used in conjunction with the W11-1.



MUTCD Bicycle Warning Sign (W11-1) with supplemental plaque (W16-1)

## Level 2: Pavement Markings

A variety of pavement marking techniques can effectively improve bicycling conditions along bicycle boulevards.

### On-Street Parking Delineation

#### **MUTCD Guidelines**

*Section 3B.18 Parking Space Markings* in the MUTCD provides support for the marking of on-street parking.

Delineating on-street parking through paint or other materials clearly indicates where a vehicle should be parked, and can discourage motorists from parking their vehicles too far into the adjacent travel lane. This helps cyclists by maintaining a wide enough space to safely share a travel lane with moving vehicles while minimizing the need to swerve farther into the travel lane to maneuver around parked cars. In addition to benefiting cyclists, delineated parking spaces also promote the efficient use of on-street parking by maximizing the number of spaces in high-demand areas, such as in the Bay Front.

### Directional Pavement Markings

#### **MUTCD Guidelines**

The MUTCD currently provides no guidance on the use of directional pavement markings for bicyclists, although *Section 9C.01 Function of Markings* provides this general support, "Markings indicate the separation of the lanes for road users, assist the bicyclist by indicating assigned travel paths, indicate correct position for traffic control signal actuation, and provide advance information for turning and crossing maneuvers."



Directional Pavement Marking – Portland (OR)

Directional pavement markings effectively lead cyclists along a



bicycle boulevard (and reinforce cyclists that they are on a designated route). The markings take the form of small bicycle symbols (about one foot in diameter) placed every 600-800 feet along a linear corridor. When a bicycle boulevard travels along several streets (with multiple turns at intersections), additional markings accompanied by directional arrows are provided to guide cyclists through turns and other complex routing areas. Directional pavement markings also visually queue motorists that they are traveling along a bicycle route and should exercise caution.

### Shared Lane Marking (Sharrow)

#### **MUTCD Guidelines**

The shared lane marking (commonly called a sharrow) is not currently approved for use by the MUTCD. The National Committee on Uniform Traffic Control Devices (NCUTCD) has recommended to the Federal Highway Administration (FHWA) that this marking be included in the next edition of the MUTCD. Until the marking is officially approved and published in the next MUTCD, its use is still considered experimental – and is not approved for use except under written experimental authorization by FHWA.

Sharrows are high-visibility pavement markings that help position bicyclists within the travel lane. These markings are often used on streets where dedicated bicycle lanes are desirable but are not possible due to physical or other constraints. Sharrows are placed strategically in the travel lane to alert motorists of bicycle traffic, while also encouraging cyclists to ride at an appropriate distance from the “door zone” of adjacent parked cars. Placed in a linear pattern along a corridor (typically every 100-200 feet) at a minimum of 11 feet from the face of curb, sharrows also encourage cyclists to ride in a straight line so their movements are predictable to motorists. These pavement markings have been successfully used in many small and large communities throughout the U.S. Sharrow markings made of thermoplastic tend to last longer than traditional paint. In Newport, sharrows could be used on bicycle boulevards with higher vehicle volumes, such as SE Bay Blvd, SW Elizabeth St, and 11<sup>th</sup> Street.

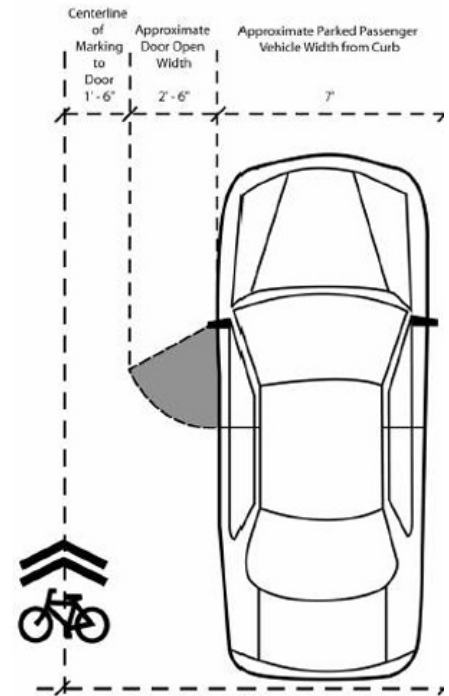

Sharrow placement on a local street

#### **Level 3: Intersection Treatments**

Described below, a variety of intersection treatments can be used to safely and conveniently facilitate bicycle travel on bicycle boulevards.

#### **Stop Sign Placement**

Placing stop signs on cross-streets approaching a bicycle boulevard can facilitate convenient through bicycle travel. A reduced number of stop signs on a designated bicycle route enables riders to maintain their momentum and exert less energy with fewer “stops and starts”. This treatment should be used judiciously to minimize the potential for increasing vehicle speeds on the bicycle boulevard. Additionally, appropriate traffic control measures should be used where bicycle boulevards intersect major streets.





### Bicycle Detection at Signalized Intersections

Several treatments can be used to streamline bicycle travel where bicycle boulevards approach intersections with actuated signals. In-pavement bicycle loop detectors can sense a bicyclist's presence (in the way that vehicle loop detectors sense automobiles) and trigger the signal to provide a "green" phase for the cyclist. Bicycle loop detectors should be placed within the bicyclist's expected path, (including left turn lanes and shoulders), and should be accompanied with a pavement marking indicating the optimal location for detection. Vehicle loop detectors can also be used for bicycle detection, provided they are located within the bicycle travel path and their "sensitivity" levels are adjusted for cyclists.

Similar to pedestrian activation buttons, bicyclist activation buttons can also be used at signalized intersections as long as they do not require cyclists to dismount or make unsafe leaning movements. These devices should be placed as close to the street as possible in a location that is unobstructed by parked vehicles or motorists making right-hand turns.

### Half Signals

Because bicycle boulevards generally travel along lower-volume minor streets, they typically have minimal treatments to accommodate bicycle/pedestrian crossings when they approach major streets. In situations where there are few "crossable" gaps and where vehicles on the major street do not stop for pedestrians and cyclists waiting to cross, "half signals" could be installed to improve the crossing environment. Half signals include pedestrian and bicycle activation buttons and may also include bicycle loop detectors on the bicycle boulevard. Many of these models have been used successfully for years overseas, and their use in the United States has increased dramatically over the last decade. Discussed in the "Signals and Signal Warrants" section (later in this chapter), a variety of half signal applications could be used on Newport's bicycle boulevard network.

### Curb Extensions

Curb extensions slow vehicle traffic by creating a visual "pinch point" for approaching motorists. Typically constructed within the on-street parking lane, these devices can calm vehicle traffic passing through or turning at an intersection. Curb extensions also benefit cyclists and pedestrians on cross-streets by reducing the crossing distance within the roadway. Curb extensions should be designed with sufficient radii to accommodate the turning movements of snowplows, school buses and emergency vehicles.

### Medians/Refuge Islands

Medians are elevated or delineated islands that break up non-motorized street crossings into multiple segments. Where shared roadways intersect major streets at unsignalized intersections, medians can be used to simplify bicyclist and pedestrian crossings on the major street. Appropriate signage should be installed on the major street to warn motorists of bicyclist/pedestrian crossings. Additionally, vegetation within the median should be low to maintain adequate sight distances for both motorists and bicyclists/pedestrians. Medians can also be used along the

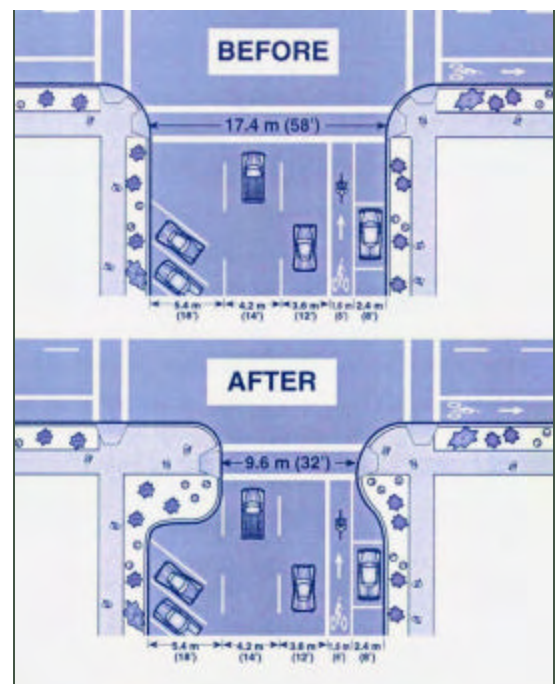

Intersection with curb extensions installed



Crossing with a median/refuge island



bicycle boulevard to create a visual pinch point for motorists as well as to accommodate mid-block bicycle/pedestrian crossings.

### **Level 4: Traffic Calming**

Traffic calming treatments on bicycle boulevards improve the bicycling environment by reducing vehicle speeds to the point where they generally match cyclists' operating speeds, enabling motorists and cyclists to safely co-exist on the same facility. Specific traffic calming treatments are described below.

#### **Chicanes**

Chicanes are a series of raised or delineated curb extensions on alternating sides of a street forming an S-shaped curb, which reduce vehicle speeds through narrowed travel lanes. Chicanes can also be achieved by establishing on-street parking on alternate sides of the street. These treatments are most effective on streets with narrower cross-sections.

#### **Mini Traffic Circles**

Mini traffic circles are raised or delineated islands placed at intersections, reducing vehicle speeds through tighter turning radii and narrowed vehicle travel lanes. These devices can effectively slow vehicle traffic while facilitating all turning movements at an intersection. Mini traffic circles can also include a paved apron to accommodate the turning radii of larger vehicles like fire trucks or school buses.

#### **Speed Humps**

Speed humps are rounded raised areas of the pavement requiring approaching motor vehicles to reduce speed. These devices also discourage through vehicle travel on a street when a parallel through route exists.

### **Level 5: Traffic Diversion**

Traffic diversion treatments maintain through bicycle travel on a street while physically restricting through vehicle traffic. These treatments direct through vehicle traffic onto parallel higher-order streets while accommodating bicyclists and local vehicle traffic on the bicycle boulevard. Traffic diversion is most effective when the higher-order streets can sufficiently accommodate the diverted traffic associated with these treatments.

#### **Choker Entrances**

Choker entrances are intersection curb extensions or raised islands allowing full bicycle passage while restricting vehicle access to and from a bicycle boulevard. When they approach a choker



Chicane



Traffic circle



Speed hump



entrance at a cross-street, motorists on the bicycle boulevard must turn onto the cross-street while cyclists may continue forward. These devices can be designed to permit some vehicle turning movements from a cross-street onto the bicycle boulevard while restricting other movements.

**Traffic Diverters**

Similar to choker entrances, traffic diverters are raised features directing vehicle traffic off the bicycle boulevard while permitting through bicycle travel.

Figure 5-2 on the following page illustrates an example of bicycle boulevard applications on a hypothetical street.

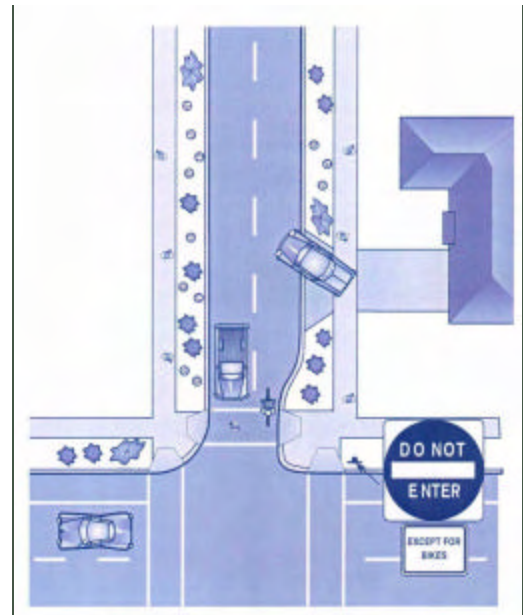

Choker at entrance of 2-way local street



Traffic diverters: median island (left) and bike/ped only refuge on NE 16<sup>th</sup> and Tillamook in Portland (right).



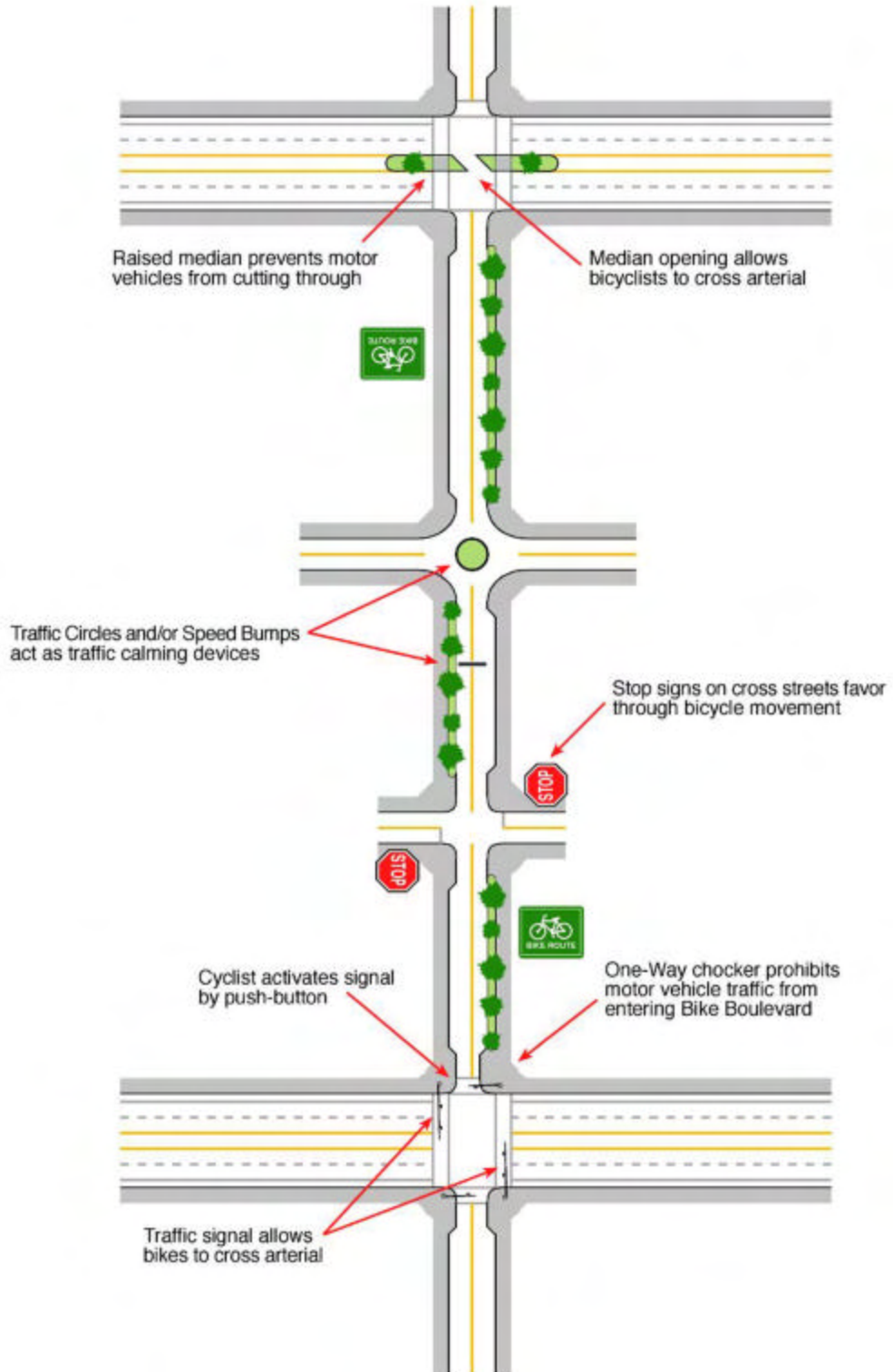

Figure 5-2. Sample Bicycle Boulevard Treatments



## Recommended Street Standards

This section discusses recommended changes to street design standards pertaining to walking and bicycling fatalities. Depending on the corridor under focus, standards are either dictated by the City of Newport or ODOT.

### ODOT Street Design Standards

Within Newport, U.S. 101 and US 20 are State highways and are therefore subject to ODOT design standards and final review for approval for any non-standard roadway treatments. Approved standards are laid out in the agency's Highway Design Manual (HDM), updated in 2003. The HDM standards are based on several parameters, including a highway's functional classification and posted speed. Within the Newport city limits, both US 101 and US 20 are classified as "Urban Principal Arterial-Other" by the HDM. This classification dictates the type and width of bicycle and pedestrian facilities on these highways. In addition, there is a state permitting process for establishing new pedestrian crossings of state facilities.

The standard width for bike lanes is six feet, with a minimum width of five feet. Sidewalks separated with a buffer are the preferred facility for pedestrians, with a standard width of six feet. However, several conditions require greater widths:

- In the absence of a buffer, an additional two feet is encouraged and should be added to the width of a curbside sidewalk.
- Curbside sidewalks should not be placed directly adjacent to a high-speed (design speed of 45 mph and above) travel lane.
- Curbside sidewalks on bridges shall be at least seven feet wide.

### City of Newport Street Design Standards

Newport's 1997 TSP outline design standards for City-owned streets. The following table summarizes existing and proposed standards for bicycle/pedestrian facilities. This Plan recommends increasing the City's bicycle lane width standard from five to six feet to provide sufficient lateral clearance for bicyclists and to enable cyclists to safely maneuver around obstructions like drainage grates.

This Plan also recommends that the City's standards be changed to require bicycle lanes on all new Arterials and Major Collectors. Bicycle lanes should also be constructed on Minor Collectors with high traffic volumes (3,000 ADT or above) or where conditions warrant the separation of bicyclists and motor vehicles.

This Plan recommends increasing the City's sidewalk width standard from five to six feet on arterials, collectors, and local streets. Discussed earlier, this width enables two pedestrians (including wheelchair users) to walk side by side, or to pass each other comfortably. It also allows two pedestrians to pass a third pedestrian without leaving the sidewalk. The city code should also be clarified, requiring a planter strip to be constructed between the sidewalk and curb.



**Table 5-1. City of Newport Existing and Proposed Street Design Standards**

Functional Classification	Bicycle Lanes		Sidewalks		Planter Strip	
	Existing Standard	Recommended Standard	Existing Standard	Recommended Standard	Existing Standard	Recommended Standard
Major Arterial	Required, 5' minimum <sup>1</sup>	Required, 6' minimum	6' minimum	6' minimum	4'	6'
Minor Arterial	Optional, 5' minimum	Required, 6' minimum	6' minimum	6' minimum	N/A	6'
Collector	Not required	Optional, 6' minimum <sup>2</sup>	5' minimum	6' minimum	N/A	4'
Local Street	Not required	Not required	5' minimum	6' minimum	N/A	4'
Woonerf – Shared Street	Not required	Not required	Not required	Not required	Not required	Not required

<sup>1</sup> Bicycle lanes should be provided on Arterials unless more desirable parallel facilities are designated and designed to accommodate bicyclists.

<sup>2</sup> Bicycle lanes should be provided on Minor Collectors where traffic volumes or other factors warrant. Otherwise, Minor Collectors should be designated and designed as shared roadways/bicycle boulevards with appropriate treatments outlined in the “Shared Roadways/Bicycle Boulevards” section of this Plan (proposed standard).

The proposed changes noted above in Table 5-1 are intended for application when new streets are being built and when major reconstruction of existing streets occurs where additional right-of-way is acquired for the planned road improvement. As the city works to fill in the bicycle and pedestrian network within the current built environment, adhering to the existing standards noted in Table 5-1 will be sufficient and a great improvement over the existing condition in many locations.



The following graphics provide some examples in the application of the proposed design standards for new and major reconstructed streets in Newport.

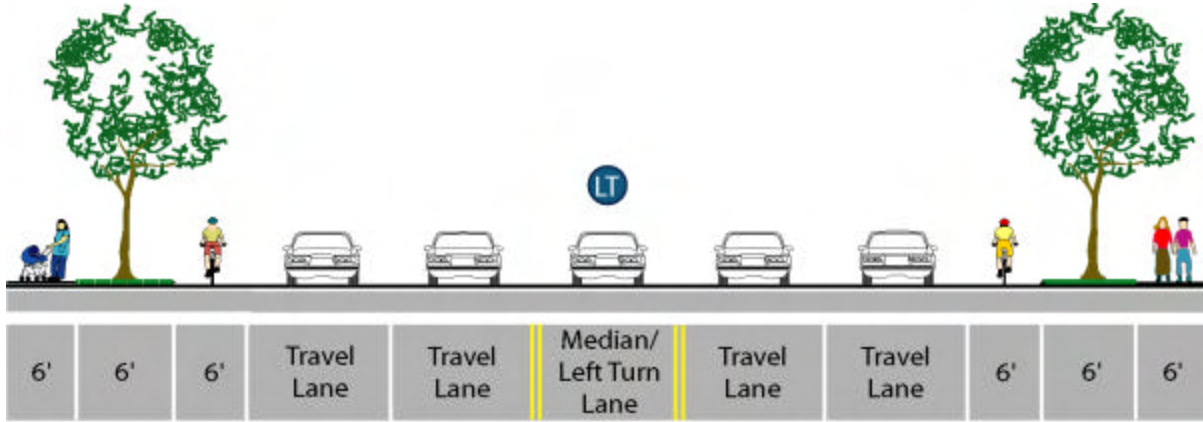

Figure 5-3. Major Roadway with 6' Minimum Planter Strip

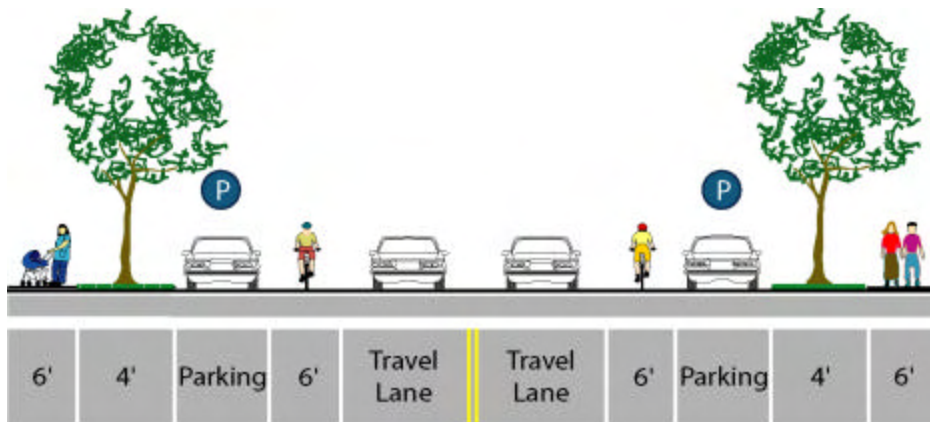

Figure 5-4. Two Lane Road with 4' Minimum Planter Strip

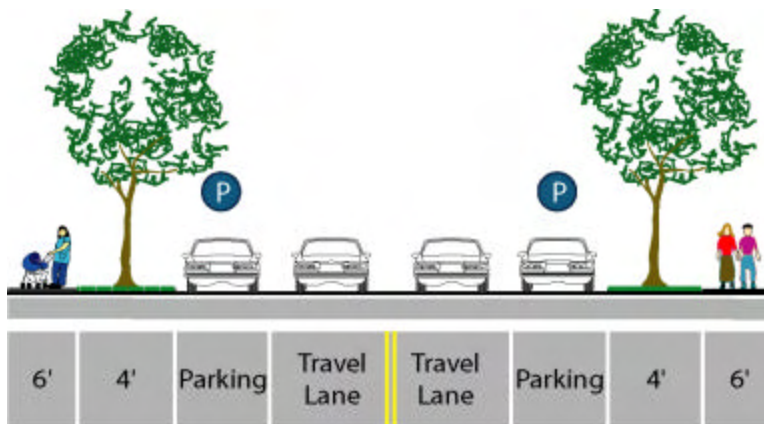

Figure 5-5. Shared Use Roadway





**Figure 5-6. Proposed "Woonerf"**

### **"Woonerf" – Shared Street**

A "Woonerf" ("Street for living") is a Dutch term for a common space created to be shared by pedestrians, bicyclists, and low-speed motor vehicles. An example is NE Cliff Street in the Nye Beach area. Woonerfs are typically narrow streets without curbs and sidewalks, and vehicles are slowed by placing trees, planters, parking areas, and other obstacles in the street. Motorists become the intruders and must travel at very low speeds. This makes a street available for public use that is essentially only intended for local residents. A woonerf identification sign is placed at each street entrance. Consideration must be given to provide access by fire trucks, sanitation vehicles and other service vehicles (school buses and street sweepers), if needed. A woonerf design also provides the opportunity to apply "green street" treatments such as permeable pavers and bioswales to reduce or eliminate the need for expensive sewer connections while improving the surrounding environment.

A woonerf is generally not appropriate where there is a need to provide nonresident motorists with access to services or through travel. The design needs to keep vehicle speeds very low in order to make the streets safe for children.

### **Green Street Treatments**

Filter strips and bio-swales are innovative and green ways to retain and treat stormwater from impervious surfaces and work well in areas where a traditional curb and gutter is not desired or not keeping with the context and feel of the surrounding area. The design guidelines for filter strips and swales are similar; both methods use grassy vegetation or aggregate to remove sediment from stormwater runoff. Use of filter strips and swales can be limited in retrofit situations due to slope, soil, and right-of-way conditions. Existing underground utility conflicts may increase cost and complexity.

### **Filter Strips**

Filter strips (Figures 5-7 and 5-8) are gently sloped grassy and aggregate areas that are used to treat small quantities of sheet flow runoff. They are often used to pretreat stormwater flow of minimal depth (.5 inches) as it passes from an impervious area, like a parking lot or roadway, into a swale or infiltration area.





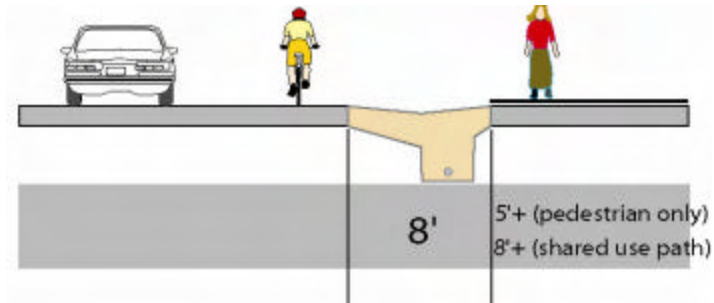

Figure 5-7. Aggregate Filter Strip

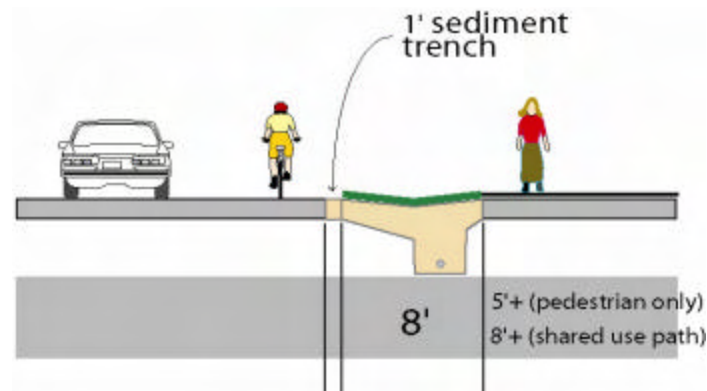

Figure 5-8. Grass Filter Strip

**Swales**

Swales (Figure 5-9) are shallow, wide depressions adjacent to roadways and trails that collect stormwater runoff over vegetation to slowly settle sediments and particulate matter. The pollutants are filtered out, settled, or removed by plants, causing fewer pollutants to enter ecologically sensitive water bodies. For more information and further design guidelines for swales and other Green Street concepts, Metro’s (OR) series of “Green Streets” guidebooks is an excellent resource.

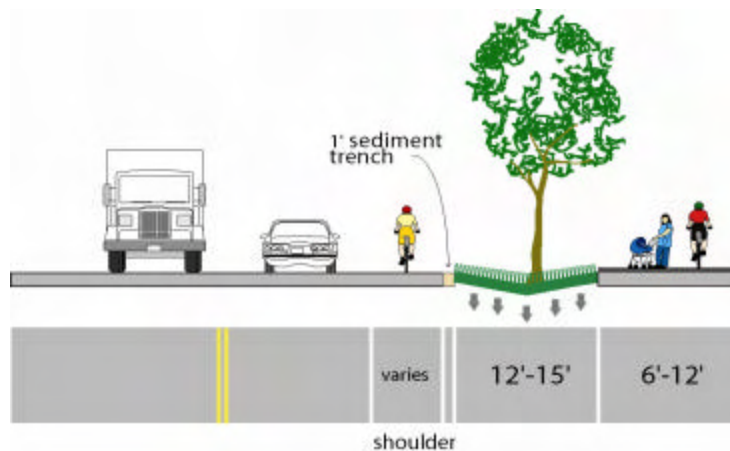

Figure 5-9. Bio-swale





**Bio-Swale**

<b>Bio-Swale Guidelines</b> (Metro, "Green Streets")	
Optimal Length	200-250 ft
Slope of sides (optimal)	1% - 2%
Slope of sides (minimum, maximum)	1%, 6%
Optimal water depth	3 inches
Optimal width	12 ft

## Transition Zones

ODOT's Highway Design Manual (HDM) discusses the importance of accommodating pedestrians and cyclists in "transition zones." These transitions often occur when high-speed rural highways (e.g., U.S. 101 and US 20) enter urbanized areas. The HDM indicates that visual queues and other design elements are critical to informing motorists that they are entering a changing environment that is urbanized, requires slower speeds, and greater attention to pedestrians, cyclists and transit vehicles. The HDM recommends various treatments on rural State highways where they enter urbanized areas, including bicycle lanes, sidewalks with planter strips, marked crosswalks and landscape features. On the State highway system in Newport, the primary rural/urban transition area exists along U.S. 101 on the north and south end of town, and where US 20 enters Newport from the east. A variety of treatments are proposed to visually queue motorists that they are entering the city, including bicycle lanes on U.S. 20 from SE Moore Dr/NE Harney St to US 101, as well as completing sidewalk gaps in this area. Pavement markings and signage will also address urban/rural transitions on other roads entering Newport.

## Intersection Treatments

Several design and operational treatments could be implemented to improve the pedestrian environment at intersections. Attributes associated with good intersection design include the following:

- **Clarity:** It should be obvious to motorists that there will be pedestrians present; it should be obvious to pedestrians where to cross.
- **Predictability:** The placement of crosswalks should be predictable. Additionally, the frequency of crossings should increase where pedestrian volumes are greater.
- **Visibility:** The location and illumination of the crosswalk allows pedestrians to see and be seen by approaching traffic while crossing.
- **Short wait :** The pedestrian does not have to wait unreasonably long for an opportunity to cross.
- **Limited exposure :** Conflict points with traffic are few, and the distance to cross is short or is divided into shorter segments with crossing islands.



- **Clear crossing:** The crosswalk is free of barriers, obstacles, and hazards and is accessible to all users. Pedestrian crossing information is available in accessible locations.

## Signal Timing Evaluation and Modification

Providing adequate pedestrian crossing time is a critical element of the walking environment at signalized intersections. The Manual on Uniform Traffic Control Devices (MUTCD) recommends traffic signal timing to assume a pedestrian walking speed of four feet per second, meaning that the length of a signal phase with parallel pedestrian movements should provide sufficient time for a pedestrian to safely cross the adjacent street. It should be noted however that the four feet per second walking speed does not reflect the walking rates of many users. At crossings where older pedestrians or pedestrians with disabilities are expected, crossing speeds as low as three feet per second may be assumed. All existing traffic signals in Newport are operated by ODOT, therefore the City and ODOT should periodically evaluate signal timing plans to ensure adequate pedestrian crossing times are provided.



Pedestrian crossing countdown signal

## Innovative Pedestrian Signal Features

### Pedestrian Countdown Signals

According to the MUTCD, "Pedestrian Signal Heads provide special types of traffic signal indications exclusively intended for controlling pedestrian traffic. These signal indications consist of the illuminated symbols of a WALKING PERSON (symbolizing WALK) and an UPRAISED HAND (symbolizing DONT WALK)." An advanced type of pedestrian signal head contains a countdown signal, in addition to the WALK/DON'T WALK symbol. The countdown signal displays the number of seconds remaining for the individual to complete their crossing. These applications could be effective throughout Newport, particularly along US 101, which is characterized by wider pedestrian crossing distances.



Dual curb ramps with detectable warning strips

### Leading Pedestrian Interval (LPI)

Including LPIs at signalized crossings provides pedestrians with a three- to four-second head start into the intersection before parallel traffic is released by the green light. LPIs ensure that pedestrians are well into the intersection and visible to turning vehicles prior to vehicles entering the crosswalk. Suggested locations for installation are US 101 / 20<sup>th</sup> Street, US 101 / 25<sup>th</sup> Street, and US 20 / US 101.

## Curb Ramps

Curb ramps are a fundamental element of an accessible public realm. A sidewalk without a curb ramp can be useless to someone in a wheelchair, forcing them back to a driveway and out into the street for access. Likewise, street crossings must be aligned and properly designed to accommodate the needs and desires of all people. Many of the single access



ramps built in previous decades direct users diagonally into the street intersection (rather than straight into the crosswalk area). This can be problematic for visually impaired pedestrians as they could experience difficulty orienting themselves toward the crosswalk. Where possible, all intersection corners should provide dual curb ramps oriented directly across the street. Curb ramps should also have detectable warning strips to accommodate the visually impaired. AASHTO's Guide for the Planning, Design, and Operation of Pedestrian Facilities and the Oregon Highway Design Manual provide further guidance on curb ramp design.

### **Crosswalks**

Newport currently uses a variety of crosswalk treatments, including "transverse" (also called "parallel bar") markings consisting of two bars crossing an intersection; "longitudinal" (also called "ladder style") markings; and combinations of these marking styles. Crosswalks with pavement texturing and color also exist in Historic Nye Beach. The MUTCD indicates that transverse crosswalks should include solid white lines six to 24 inches wide (extending across the full pavement width), with a minimum of six feet between the lines. Longitudinal crosswalk bars should be 12 to 24 inches wide, at least six feet long, with 1- to 5-foot spacing between each bar (the space between bars should not exceed 2.5 times the bar width). To minimize maintenance costs, the bars should not be placed directly within vehicle wheel paths (where possible).

Where crosswalks are located at unsignalized crossings of US 101, they should be accompanied by advance stop bars striped 30 feet back from the crosswalk within the vehicle travel lanes. Advance stop bars provide additional protection to pedestrians while improving communication between pedestrians and drivers.



## Signals and Signal Warrants

### Full Signalized Crossings

The Federal government has provided guidance to determine where traffic control signals should be considered for installation. The Pedestrian Volume signal warrant is intended for the application where traffic volumes on a major street are high enough that pedestrians on an approaching side street or path experience excessive delay in crossing the major street. Section 4C.05 of the MUTCD details Warrant 4, Pedestrian Volume. For signal warrant analysis, a location with a wide median, even if the median width is greater than nine meters (30 feet), should be considered as one intersection.

#### Warrant 4, Pedestrian Volume

**Support:**

The Pedestrian Volume signal warrant is intended for application where the traffic volume on a major street is so heavy that pedestrians experience excessive delay in crossing the major street.

**Standard:**

The need for a traffic control signal at an intersection or mid-block crossing shall be considered if an engineering study finds that both of the following criteria are met:

- A. The pedestrian volume crossing the major street at an intersection or mid-block location during an average day is 100 or more for each of any 4 hours or 190 or more during any 1 hour;
- B. There are fewer than 60 gaps per hour in the traffic stream of adequate length to allow pedestrians to cross during the same period when the pedestrian volume criterion is satisfied. Where there is a divided street having a median of sufficient width for pedestrians to wait, the requirement applies separately to each direction of vehicular travel.

At non-intersection crossings, the traffic control signal should be pedestrian-actuated, parking and other sight obstructions should be prohibited for at least 30 m (100 ft) in advance of and at least 6.1 m (20 ft) beyond the crosswalk, and the installation should include suitable standard signs and pavement markings if a traffic control signal is justified by both this signal warrant and a traffic engineering study.

The criterion for the pedestrian volume crossing the major roadway may be reduced as much as 50 percent if the average crossing speed of pedestrians is less than 1.2 m/sec (4 ft/sec).



Warrant 5, School Crossing, is another signal warrant that could have applications in Newport. Several Collector streets in Newport connect schools and surrounding neighborhoods, with some of these streets serving primary commuter routes for students. Furthermore, cities like Sacramento have modified their usage projections by upwardly accounting for youth, disabled, and elderly populations through the “Equivalent Adult Units” factors (see the chart at right) at intersections that are deemed to present special circumstances:

Equivalent Adult Units	
Type	Factor
Child	2
Senior	1.5
Disabled	2

- Forty pedestrians cross during a one-hour period, or 25 cross per hour for four consecutive hours using the Equivalent Adult Units system.<sup>1</sup>
- Fewer than five gaps in traffic during the peak five-minute period.<sup>3</sup>

### Warrant 5, School Crossing

**Support:**

The School Crossing signal warrant is intended for the application where the fact that schoolchildren cross the major street is the principal reason to consider installing a traffic control signal.

**Standard:**

The need for a traffic control signal shall be considered when an engineering study of the frequency and adequacy of gaps in the vehicular traffic stream as related to the number and size of groups of school children at an established crossing across the major street shows that the number of adequate gaps in the traffic stream during the period when the children are using the crossing is less than the number of minutes in the same period (see Section 7A.03<sup>2</sup>) and there are a minimum of 20 students during the highest crossing hour.

Before a decision is made to install a traffic control signal, consideration shall be given to the implementation of other remedial measures, such as warning signs and flashers, school speed zones, school crossing guards, or a grade-separated crossing.

The School Crossing signal shall not be applied at locations where the distance to the nearest traffic control signal along the major street is less than 90 m (300 ft), unless the proposed traffic control signal will not restrict the progressive movement of traffic.

**Guidance:**

If this warrant is met and a traffic control signal is justified by an engineering study, then:

- A. If at an intersection, the traffic control signal should be traffic-actuated and should include pedestrian detectors.
- B. If at a nonintersection crossing, the traffic control signal should be pedestrian-actuated, parking and other sight obstructions should be prohibited for at least 30 m (110 ft) in advance of and at least 6.1 m (20 ft) beyond the crosswalk, and the installation should include suitable standard signs and pavement markings.
- C. Furthermore, if installed within a signal system, the traffic control signal should be coordinated.

<sup>1</sup> Use of a system of Equivalent Adult Units is recommended in order to recognize intersections that require special attention due to the presence of seniors or children, even if they don't meet the volume requirement. These two groups are disproportionately represented in collision and fatality statistics.

<sup>2</sup> "Alternate gaps and blockades are inherent in the traffic stream and are different at each crossing location. For safety, students need to wait for a gap in traffic that is of sufficient duration to permit reasonably safe crossing. When the delay between the occurrence of adequate gaps becomes excessive, students might become impatient and endanger themselves by attempting to cross the street during an inadequate gap."

<sup>3</sup> Average number of gaps per five-minute period = total usable gap time in seconds divided by pedestrian crossing rate at four feet per second, multiplied by 12.



## Half Signalized Crossings

In situations where there are few “crossable” gaps and where vehicles do not stop for pedestrians waiting to cross (or because of multiple lanes, it is unsafe to cross in front of a stopped vehicle), there are a number of innovative pedestrian traffic signals that do not operate as full signals that could be installed. Many of these models have been used successfully for years overseas, and their use in the United States has increased dramatically over the last decade. However, these types of signals are not yet included in the MUTCD, and are not available for use on state facilities.

### Pelican Signals

A Pelican (Pedestrian Light Control Activated crossing) signal incorporates a standard red-yellow-green signal light that rests in green for vehicular traffic until a pedestrian wishes to cross and presses the button. The signal then changes to yellow, then red, while WALK is shown to the pedestrian. The signal can be installed as either a one-stage or two-stage signal, depending on the street’s characteristics. In a two-stage crossing, the pedestrian crosses first to a median island and is then channelized along the median to a second signalized crossing point. At that point, the pedestrian then activates a second crossing button and another crossing signal changes to red for the traffic while the pedestrian is given a WALK signal. The two crossings only delay the pedestrian minimally and allow the signal operation to fit into the arterial synchronization, thus reducing the potential for stops, delays, accidents, and air quality issues. A Pelican crossing is quite effective in providing a pedestrian crossing at mid-block locations when the technique can be integrated into the roadway design.

### Puffin Signals

A Puffin (Pedestrian User Friendly Intelligent) crossing signal is an updated version of a Pelican crossing. The signal consists of traffic and pedestrian signals with push-button signals and infrared or pressure mat detectors. After a pedestrian pushes the button, a detector verifies the presence of the pedestrian at the curbside. This helps eliminate false signal calls associated with people who push the button and then decide not to cross. When the pedestrian is given the WALK signal, a separate motion detector extends the WALK interval (if needed) to ensure that slower pedestrians have time to cross safely. Conversely, the signal can also detect when the intersection is clear of pedestrians and return the green signal to vehicles, reducing vehicle delay at the light. Puffin signals are designed to be crossed in a single movement by the pedestrian, unlike the Pelican signal, which can be designed to cross in either one or two stages.

### Hawk Signals

A Hawk (High-Intensity Activated Crosswalk) signal is a combination of a beacon flasher and traffic control signaling technique for marked crossings. The beacon signal consists of a traffic signal head with a red-yellow-red lens. The unit is normally off until activated by a pedestrian. When pedestrians wish to cross the street, they press a button and the signal begins with a flashing yellow indication to warn approaching drivers. A solid yellow, advising the drivers to prepare to stop,



Pelican signal in Tucson, AZ



Puffin signal



Hawk signal



then follows the flashing yellow. The signal is then changed to a solid red, at which time the pedestrian is shown a WALK indicator. The beacon signal then converts to an alternating flashing red, allowing the drivers to proceed after stopping at the crosswalk, while the pedestrian is shown the flashing DON'T WALK signal.

## Crossing Treatments

Like most bicycle and pedestrian systems in built urban areas, non-motorized users in Newport must cross roadways at certain points. While at-grade crossings create a potentially high level of conflict between bicyclists and pedestrians and motorists, well-designed crossings have not historically posed a safety problem. In most cases, intersection crossings can be properly designed at-grade to a reasonable degree of safety and meet existing traffic and safety standards.

Evaluation of intersections involves analysis of vehicular and anticipated path user traffic patterns, including vehicle speeds, traffic volumes (average daily traffic and peak hour traffic), street width, sight distance and user profile (age distribution, destinations served). Crossing features for all roadways include warning signs both for vehicles and path users. The type, location, and other criteria are identified in AASHTO's Guide for the Development of Bicycle Facilities and the MUTCD. Consideration must be given for adequate warning distance based on vehicle speeds and line of sight, with visibility of any signing absolutely critical. Catching the attention of motorists jaded to roadway signs may require additional alerting devices such as a flashing light, roadway striping or changes in pavement texture. Care must be taken not to place too many signs at crossings lest they begin to lose their impact.

The following section identifies several roadway crossing treatments that should be considered for Newport's bicycle and pedestrian system.

### Roadway Crossing Prototypes

The proposed intersection approach that follows is based on established standards, published technical reports,<sup>4</sup> and experiences from cities around the country.<sup>5</sup> Intersection crossings generally will fit into one of four basic categories:

- Type 1: Marked/Unsignalized; Type 1+: Marked/Enhanced
- Type 2: Route Users to Existing Signalized Intersection
- Type 3: Signalized/Controlled
- Type 4: Grade-separated crossings

#### Type 1: Marked/Unsignalized Crossings

A marked/unsignalized crossing (Type 1) consists of a crosswalk, signage, and often no other devices to slow or stop traffic. The approach to designing crossings at mid-block locations depends on an evaluation of vehicular traffic, line of sight, route traffic, use patterns, vehicle speed, road type and width, and other safety issues such as proximity to schools. The following thresholds recommend where unsignalized crossings may be acceptable:

Maximum traffic volumes:

---

<sup>4</sup> Federal Highway Administration (FHWA) Report, "Safety Effects of Marked vs. Unmarked Crosswalks at Uncontrolled Locations."

<sup>5</sup> In particular, the recommendations in this report are based in part on experiences in cities like Portland (OR), Seattle (WA), Tucson (AZ), and Sacramento (CA), among others





- =9,000-12,000 Average Daily Traffic (ADT) volumes
- Up to 15,000 ADT on two-lane roads, preferably with a median.
- Up to 12,000 ADT on four-lane roads with median.

Maximum travel speed:

- 35 MPH

Minimum line of sight:

- 25 MPH zone: 155 feet
- 35 MPH zone: 250 feet
- 45 MPH zone: 360 feet

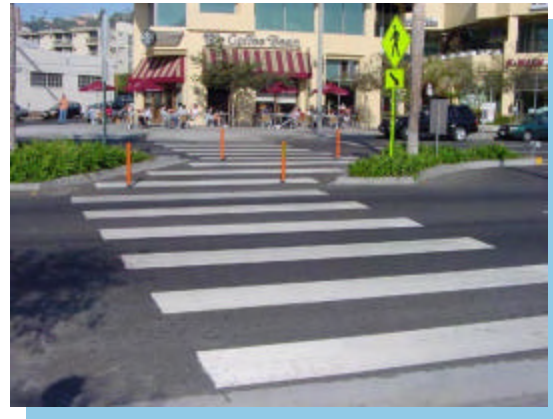

Type 1 Crossing

On two-lane residential and collector roads below 15,000 ADT with average vehicle speeds of 35 MPH or less, crosswalks and warning signs ("Path Xing") should be provided to warn motorists, with engineering judgment used to determine the appropriate level of traffic control and design.

### ***Type 1 Enhanced (Type 1+)***

If well-designed, crossings of multi-lane higher-volume arterials over 15,000 ADT may be unsignalized with features such as a combination of some or all of the following: excellent sight distance, sufficient crossing gaps (more than 60 per hour), median refuges, and/or active warning devices like flashing beacons or in-pavement flashers. These are referred to as "Type 1 Enhanced" (Type 1+). Such crossings would not be appropriate; however, if a significant number of school children used the identified route. Furthermore, both existing and potential future non-motorized traffic volume should be taken into consideration.



Figure 5-10. Type 1+ Crossing with Median



On roadways with low to moderate traffic volumes (<12,000 ADT) and a need to control traffic speeds, a raised crosswalk may be the most appropriate crossing design to improve pedestrian visibility and safety. These crosswalks are raised 75 millimeters above the roadway pavement (similar to speed humps) to an elevation that matches the adjacent sidewalk. The top of the crosswalk is flat and typically made of asphalt, patterned concrete, or brick pavers. Brick or unit pavers should be discouraged because of potential problems related to pedestrians, bicycles, and ADA requirements for a continuous, smooth, vibration-free surface. Detectable warning strips are needed at the sidewalk/street boundary so that visually impaired pedestrians can identify the edge of the street.

**Type 2: Route Users to Existing Signalized Intersection**

Crossings within 250 feet of an existing signalized intersection with pedestrian crosswalks are typically diverted to the signalized intersection for safety purposes. For this option to be effective, barriers and signing may be needed to direct trail users to the signalized crossings. In most cases, signal modifications would be made to add pedestrian detection and to comply with the Americans with Disabilities Act.

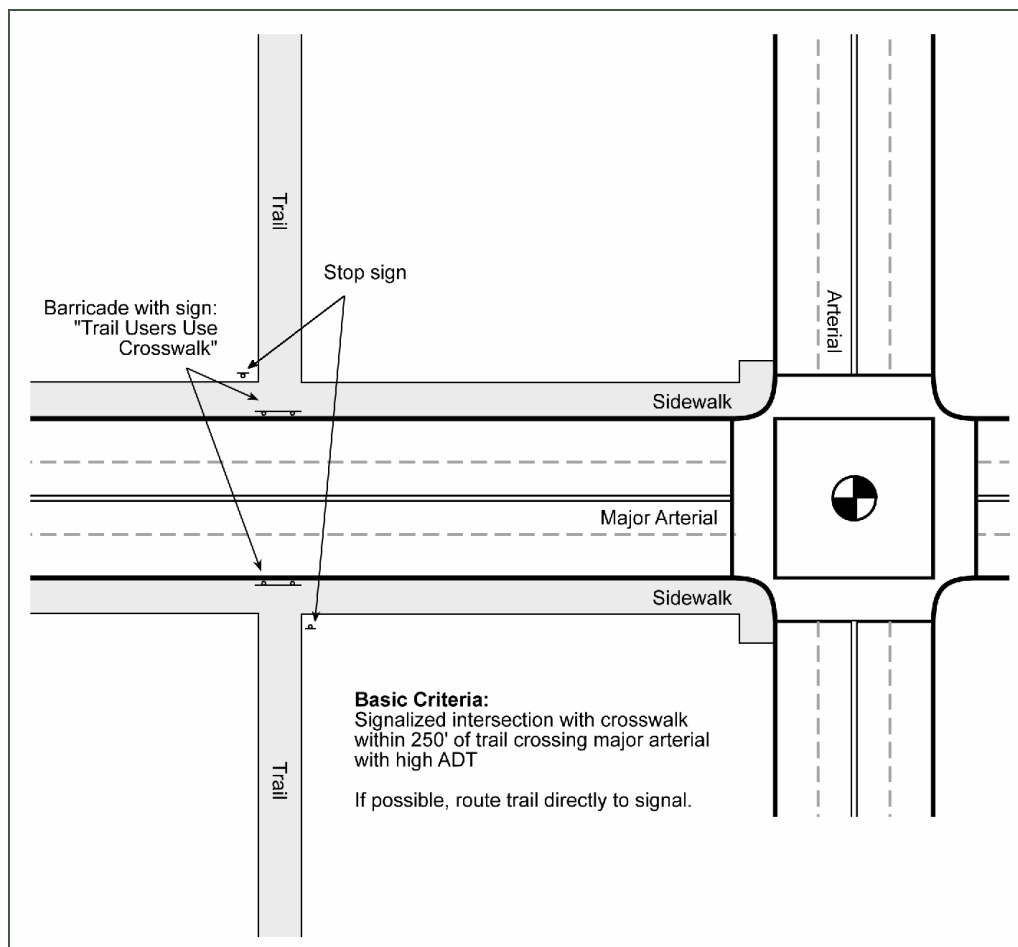

**Figure 5-11. Type 2 Crossing Treatment**



### Type 3: Signalized/Controlled Crossings

New signalized crossings may be recommended for crossings that meet pedestrian, school, or modified warrants, are located more than 250 feet from an existing signalized intersection and where 85th percentile travel speeds are 40 MPH and above and/or ADT exceeds 15,000 vehicles. Each crossing, regardless of traffic speed or volume, requires additional review by a registered engineer to identify sight lines, potential impacts on traffic progression, timing with adjacent signals, capacity, and safety.

The maximum delay for activation of the signal should be two minutes, with minimum crossing times determined by the width of the street. The signals may rest on flashing yellow or green for motorists when not activated, and should be supplemented by standard advanced warning signs. As described in the “Half Signalized Crossings” section earlier in this chapter, various types of pedestrian signals exist and can be used at Type 3 crossings.



Type 3 Crossing

### Type 4: Grade-separated Crossings

Grade-separated crossings may be needed where existing bicycle/pedestrian crossings do not exist, where ADT exceeds 25,000 vehicles, and where 85th percentile speeds exceed 45 MPH. Safety is a major concern with both overcrossings and undercrossings. In both cases, users may be temporarily out of sight from public view and may have poor visibility themselves. Undercrossings, like parking garages, have the reputation of being places where crimes occur. Most crime on trails, however, appears to have more in common with the general crime rate of the community and the overall usage of the trail than any specific design feature.

Design and operation measures are available which can address trail user concerns. For example, an undercrossing can be designed to be spacious, well-lit, equipped with emergency cell phones at each end and completely visible for its entire length prior to entering. Other potential problems with undercrossings include conflicts with utilities, drainage, flood control, and maintenance requirements. Overcrossings pose potential concerns about visual impact and functional appeal, as well as space requirements necessary to meet ADA guidelines for slope.



Type 4 Grade-Separated Undercrossing



Type 4 Grade-Separated Overcrossing



**Summary of At-Grade Crossing Recommendations**

Table 5-2 provides guidance on how to implement at-grade path/roadway crossings in Newport.

**Table 5-2. Summary of At-Grade Crossing Recommendations<sup>6</sup>**

Roadway Type (Number of Travel Lanes and Median Type)	Vehicle ADT ≤ 9,000			Vehicle ADT > 9,000 to 12,000			Vehicle ADT > 12,000 to 15,000			Vehicle ADT > 15,000		
	Speed Limit **											
	30 mi/h	35 mi/h	40 mi/h	30 mi/h	35 mi/h	40 mi/h	30 mi/h	35 mi/h	40 mi/h	30 mi/h	35 mi/h	40 mi/h
2 Lanes	1	1	1/1+	1	1	1/1+	1	1	1+3	1	1/1+	1+3
3 Lanes	1	1	1/1+	1	1/1+	1/1+	1/1+	1/1+	1+3	1/1+	1+3	1+3
Multi-Lane (4 or more lanes) with raised median ***	1	1	1/1+	1	1/1+	1+3	1/1+	1/1+	1+3	1+3	1+3	1+3
Multi-Lane (4 or more lanes) without raised median	1	1/1+	1+3	1/1+	1/1+	1+3	1+3	1+3	1+3	1+3	1+3	1+3
<p><b>*General Notes:</b> Crosswalks should not be installed at locations that could present an increased risk to pedestrians, such as where there is poor sight distance, complex or confusing designs, a substantial volume of heavy trucks, or other dangers, without first providing adequate design features and/or traffic control devices. Adding crosswalks alone <b>will not</b> make crossings safer, nor will they necessarily result in more vehicles stopping for pedestrians. Whether or not marked crosswalks are installed, it is important to consider other pedestrian facility enhancements (e.g., raised median, traffic signal, roadway narrowing, enhanced overhead lighting, traffic-calming measures, curb extensions), as needed, to improve the safety of the crossing. <b>These are general recommendations; good engineering judgment should be used in individual cases for deciding which treatment to use.</b></p> <p>For each pathway -roadway crossing, an engineering study is needed to determine the proper location. For each engineering study, a site review may be sufficient at some locations, while a more in-depth study of pedestrian volume, vehicle speed, sight distance, vehicle mix, etc. may be needed at other sites.</p>												
<p>** Where the speed limit exceeds 40 mi/h (64.4 km/h), marked crosswalks alone should not be used at unsignalized locations.</p>												
<p>*** The raised median or crossing island must be at least four ft (1.2 m) wide and six ft (1.8 m) long to adequately serve as a refuge area for pedestrians in accordance with MUTCD and AASHTO guidelines. A two-way center turn lane is not considered a median.</p>												
<p>1= Type 1 Crossings. Ladder-style crosswalks with appropriate signage should be used.</p>												
<p>1/1+ = With the higher volumes and speeds, enhanced treatments should be used, including marked ladder style crosswalks, median refuge, flashing beacons, and/or in-pavement flashers. Ensure there are sufficient gaps through signal timing, as well as sight distance.</p>												
<p>1+3 = Carefully analyze signal warrants using a combination of Warrant 2 or 5 (depending on school presence) and EAU factoring. Make sure to project pathway usage based on future potential demand. Consider Pelican, Puffin, or Hawk signals in lieu of full signals. For those intersections not meeting warrants or where engineering judgment or cost recommends against signalization, implement Type 1 enhanced crosswalk markings with marked ladder style crosswalks, median refuge, flashing beacons, and/or in-pavement flashers. Ensure there are sufficient gaps through signal timing, as well as sight distance.</p>												

<sup>6</sup> This table is based on information contained in the U.S. Department of Transportation Federal Highway Administration Study, "Safety Effects of Marked vs. Unmarked Crosswalks at Uncontrolled Locations," February 2002.



## Pedestrian-Ways

Pedestrian-ways (also known as “accessways”) provide direct connections to schools, parks, community centers, retail areas, neighborhoods, and other paths. They are intended to be short, direct connections to reduce unnecessary out-of-direction travel for bicyclists and pedestrians. Pedestrian-ways should be at least 10 feet wide, and “be of such design and location as reasonably required to pedestrian travel, and shall be dedicated to the public.”

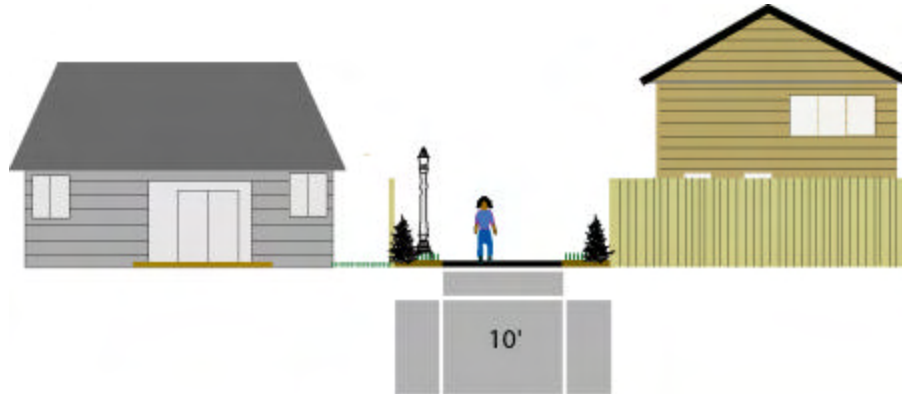

**Figure 5-12. Pedestrian-Ways (or “Accessways”)**

## Shared-Use Paths

As the City of Newport develops its shared-use path network, several design issues should be taken into consideration. Shared-use paths should be designed to accommodate two-way bicycle and pedestrian traffic, and typically should have their own rights-of-way (for a minimum of 75 percent of their length to reinforce the experience of traveling on a path). Because most of the proposed paths will also serve maintenance vehicles, the paved surface should be asphalt or concrete (or a durable unpaved surface that is smooth and meets ADA requirements).

The graphic below depicts the recommended cross-section for shared-use paths in Newport. A narrower path width may be allowed (8 feet minimum) in physically constrained areas. Wider path widths are recommended in areas where user volumes are expected to be high. Soft shoulders (at least two feet wide) should be provided on both sides of the path, and a wider shoulder should be provided to accommodate runners and joggers where space permits. Soft shoulders may consist of bark or wood chips.



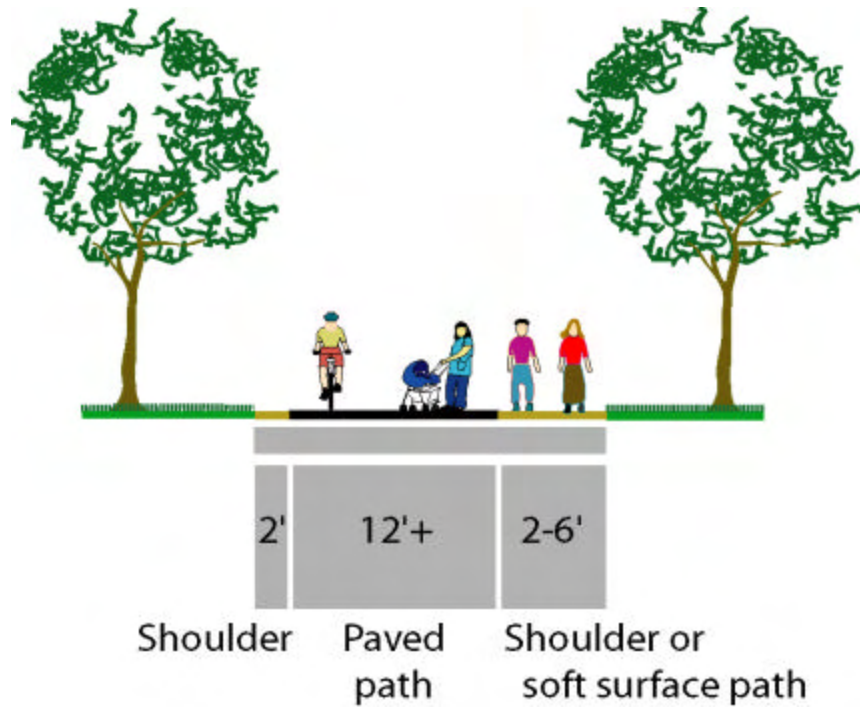

**Figure 5-13. Shared-Use Paths**

Shared-use paths should also be designed to restrict access from unauthorized vehicles. Bollards can be placed at path/roadway crossings to permit bicycle/pedestrian access while restricting vehicle access. Removable and unlockable bollards also maintain easy path access for maintenance and emergency vehicles.

Table 5-3 highlights additional design recommendations for Newport's shared-use path network. The recommendations are based on experience in other communities, as well as guidelines prescribed by AASHTO and the *Oregon Bicycle and Pedestrian Plan*.



**Table 5-3. Shared-Use Path Design Recommendations**

Parameter	Recommendation
Paved width	12' (8' in constrained areas)
Soft surface width	6' minimum
Shoulder width <sup>1</sup>	2' minimum
Lateral clearance between path and adjacent signs	3'-6'
Overhead clearance	8' minimum
Separation from parallel roadway	5' minimum
Grade/running slope	5% maximum
Cross-slope	2% maximum
Fence height	54 inches
Bollards	5' minimum between bollards

Source: AASHTO Guide for the Development of Bicycle Facilities; ODOT Oregon Bicycle and Pedestrian Plan.

1 A soft surface path paralleling the paved path can take the place of a shoulder on one side.

### Shared-Use Paths along Roadways

Shared-use paths should not be placed directly adjacent to roadways (e.g., with minimal or no separation) for variety of reasons:

- Half of bicycle traffic would ride against the normal flow of vehicle traffic, contrary to the rules of the road.
- When the path ends, cyclists riding against traffic tend to continue to travel on the wrong side of the street, as do cyclists making their way to the path. Wrong-way bicycle travel is a major cause of vehicle/bicycle crashes.
- At intersections, motorists crossing the path often do not notice bicyclists approaching from certain directions, especially where sight distances are poor.
- Bicyclists on the path are required to stop or yield at cross-streets and driveways, unless otherwise posted.
- Stopped vehicles on a cross-street or driveway may block the path.
- Because of the closeness of vehicle traffic to opposing bicycle traffic, barriers are often necessary to separate motorists from cyclists. These barriers serve as obstructions, complicate facility maintenance and waste available right-of-way.
- Paths directly adjacent to high-volume roadways diminish users' experience by placing them in an uncomfortable environment. This could lead to a path's underutilization.

Shared-use paths can successfully be placed along roadways, provided several design considerations are met:

- A minimum 5-foot buffer should be provided between the path and roadway to address potential conflicts between motorists and path users.



- There are few vehicle/path user conflict points (e.g., cross-streets and driveways).
- There is a commitment to provide path continuity along the corridor.
- The path can be terminated at each end onto streets with good bicycle and pedestrian facilities or onto another safe, well-designed path through appropriate street crossing treatments.
- The path should not take the place of bicycle/pedestrian facilities (e.g., sidewalks and bicycle lanes) on the parallel street.

### **Sidewalks as Shared-Use Paths**

Utilizing or providing a sidewalk as a shared-use path is unsatisfactory for several reasons. Sidewalks are typically designed for pedestrian speeds and maneuverability and are not safe for higher bicycle speeds. Conflicts are common between pedestrians traveling at low speeds (e.g., exiting stores, parked cars, etc.) and bicyclists, as are conflicts with fixed objects (e.g., utility poles, mailboxes, parked cars extending into the sidewalk from a driveway). Walkers, joggers, skateboarders and in-line skaters can (and often do) change their speed and direction almost instantaneously, leaving bicyclists insufficient reaction time to avoid collisions.

Similarly, pedestrians often have difficulty predicting the direction an oncoming cyclist will take. At intersections, motorists are often not looking for bicyclists who are traveling at higher speeds than pedestrians) entering a crosswalk area, particularly when motorists are making a turn. Sight distance is often impaired by buildings, walls, fences and shrubs along sidewalks, especially at driveways. In addition, bicyclists and pedestrians often prefer to ride or walk side-by-side when traveling in pairs. Sidewalks are typically too narrow to enable this to occur without serious conflict between users.

It should also be noted that developing extremely wide sidewalks does not necessarily add to the safety of sidewalk bicycle travel. Wide sidewalks might encourage higher speed bicycle use and can increase the potential for conflicts with motorists at intersections, as well as pedestrians with fixed objects.





## Path Amenities

A variety of amenities can make a path inviting to the user. The following table highlights some common items that make path systems stand out. Costs vary depending on the design and materials selected for each amenity.



### **Interpretive Installations**

Interpretive installations and signs can enhance the users experience by providing information about the history of Newport and the surrounding area. Installations can also discuss local ecology, environmental concerns, and other educational information.



### **Water Fountains and Bicycle Parking**

Water fountains provide water for people (and pets, in some cases) and bicycle racks allow recreational users to safely park their bikes if they wish to stop along the way, particularly at parks and other desirable destinations.



### **Pedestrian-Scale Lighting and Furniture**

Pedestrian-scale lighting improves safety and enables the facility to be used year-round. It also enhances the aesthetic of the pathway. Lighting fixtures should be consistent with other light fixtures in the city, possibly emulating a historic theme.

Providing benches at key rest areas and viewpoints encourages people of all ages to use the pathway by ensuring that they have a place to rest along the way. Benches can be simple (e.g., wood slats) or more ornate (e.g., stone, wrought iron, concrete).



### **Maps and Signage**

A comprehensive signing system makes a bicycle and pedestrian system stand out. Informational kiosks with maps at trailheads and other pedestrian generators can provide enough information for someone to use the network with little introduction – perfect for areas with high out-of-area visitation rates as well as the local citizens.



### **Art Installations**

Local artists can be commissioned to provide art for the pathway system, making it uniquely distinct. Many pathway art installations are functional as well as aesthetic, as they may provide places to sit and play on.





**Landscaping**

Landscape features, including street trees or trees along paths, can enhance the visual environment and improve the path user experience. Trees can also provide shade from heat and also provide protection from rain.



**Restrooms**

Restrooms benefit path users, especially in more remote areas where other facilities do not exist. Restrooms can be sited at major trailheads or at other strategic locations along the path system.

**Path Safety and Security**

Various design and programmatic measures can be taken to address safety issues on a shared-use path. Table 5-4 summarizes key safety issues and strategies for minimizing impacts.

**Table 5-4. Safety Recommendations**

Safety Issue	Recommended Improvements
Unwanted vehicle access on the path	<ul style="list-style-type: none"> <li>• Utilize landscaping to define the corridor edge and path, including earth berms and large boulders.</li> <li>• Use bollards at intersections</li> <li>• Pass a motorized vehicle prohibited ordinance and sign the path.</li> <li>• Create a Path Watch Program and encourage citizens to photograph report illegal vehicle use of the corridor.</li> <li>• Lay the trail out with curves that allow bike/ped passage, but are uncomfortably tight for automobile passage.</li> </ul>
Privacy of adjacent property owners	<ul style="list-style-type: none"> <li>• Encourage the use of neighborhood friendly fencing and also planting of landscape buffers.</li> <li>• Clearly mark path access points.</li> <li>• Post path rules that encourage respect for private property.</li> <li>• Strategically placed lighting.</li> </ul>
Litter and dumping	<ul style="list-style-type: none"> <li>• Post path rules encouraging pack-it-in/pack-it-out etiquette.</li> <li>• Place garbage receptacles at trailheads.</li> <li>• Strategically-placed lighting, utilizing light shields to minimize unwanted light in adjacent homes.</li> <li>• Manage vegetation within the right-of-way to allow good visual surveillance of the path from adjacent properties and from roadway/path intersections.</li> <li>• Encourage local residents to report incidents as soon as they occur.</li> <li>• Remove dumpsites as soon as possible.</li> </ul>
Trespassing	<ul style="list-style-type: none"> <li>• Clearly distinguish public path right-of-way from private property through the use of vegetative buffers and the use of good neighbor type fencing.</li> <li>• Post path rules that encourage respect for private property.</li> </ul>



Safety Issue	Recommended Improvements
Crime	<ul style="list-style-type: none"> <li>• Manage vegetation so that corridor can be visually surveyed from adjacent streets and residences.</li> <li>• Select shrubs that grow below 3' in height and trees that branch out greater than 6' in height.</li> <li>• Place lights strategically and as necessary.</li> <li>• Place benches and other path amenities at locations with good visual surveillance and high activity.</li> <li>• Provide mileage markers at quarter-mile increments and clear directional signage for orientation.</li> <li>• Create a "Path Watch Program" involving local residents.</li> <li>• Proactive law enforcement. Utilize the corridor for mounted patrol training.</li> </ul>
Private use of corridor	<ul style="list-style-type: none"> <li>• Attempt to negotiate win/win solutions with property owners.</li> <li>• Eliminate where detrimental impact to path cannot be reasonably ameliorated.</li> </ul>
Local on-street parking	Post local residential streets as parking for local residents only to discourage path user parking. Place "no outlet" and "no parking" signs prior to path access points.
Trailhead safety	Clearly identify trailhead access areas.
Vandalism	<ul style="list-style-type: none"> <li>• Select benches, bollards, signage and other site amenities that are durable, low maintenance and vandal resistant.</li> <li>• Respond through removal or replacement in rapid manner.</li> <li>• Keep a photo record of all vandalism and turn over to local law enforcement.</li> <li>• Encourage local residents to report vandalism.</li> <li>• Create a Trail Watch Program; maintain good surveillance of the corridor.</li> <li>• Involve neighbors in path projects to build a sense of ownership.</li> <li>• Place amenities (benches, etc.) in well used and highly visible areas.</li> </ul>

### **Community Involvement with Safety on the Path**

Creating a safe path environment goes beyond design and law enforcement and should involve the entire community. The most effective and most visible deterrent to illegal activity on Newport's path system will be the presence of legitimate path users. Getting as many "eyes on the corridor" as possible is a key deterrent to undesirable activity. There are several components to accomplishing this as outlined below.

#### **Provide good access to the path**

Access ranges from providing conveniently located trailheads along the path, to encouraging the construction of sidewalks to accommodate access from private developments adjacent to the path. Access points should be inviting and signed so as to welcome the public onto the path.

#### **Good visibility from adjacent neighbors**

Neighbors adjacent to the path can potentially provide 24-hour surveillance of the path and can become Newport's biggest ally. Though some screening and setback of the path is needed for privacy of adjacent neighbors, complete blocking out of the path from neighborhood view should be discouraged. This eliminates the potential of neighbors' "eyes on the path," and could result in a "tunnel effect" on the path.

#### **High level of maintenance**

A well-maintained path sends a message that the community cares about the public space. This message alone will discourage undesirable activity along the path.



### Programmed events

Community events along the path will help increase public awareness and thereby attract more people to use the path. Neighbors and residents can help organize numerous public events along the path which will increase support for the path. Events might include a day-long path clean up or a series of short interpretive walks led by long time residents or a park naturalist.

### Community projects

The support generated by community groups could be further capitalized by involving neighbors and friends of the path in a community project. Ideas for community projects include volunteer planting events, art projects, interpretive research projects, or even bridge building events. These community projects are the strongest means of creating a sense of ownership along the path that is perhaps the strongest single deterrent to undesirable activity along the path.

### Adopt-a-Path Program

Nearby businesses, community institutions, and residential neighbors often see the benefit of their involvement in the path development and maintenance. Businesses and developers may view the path as an integral piece of their site planning and be willing to take on some level of responsibility for the path. Creation of an adopt-a-path program should be explored to capitalize on this opportunity and build civic pride.

### Path Watch Program

Partnering with local and county law enforcement, a path watch program would provide an opportunity for local residents to become actively involved in crime prevention along Newport's path system. Similar to Neighborhood Watch programs, residents are brought together to get to know their neighbors, and are educated on how to recognize and report suspicious activity.

## Internal Circulation Standards

Pedestrian circulation in larger residential and commercial developments is influenced by the infrastructure provided for the pedestrian as well as the infrastructure and design of auto circulation and parking.

### Automobile Infrastructure

Parking lots should be located in such a manner as to encourage pedestrian access to the development, connect uses to the street and decrease the distance between adjacent developments. To accomplish this, parking should be located behind and to the side of buildings wherever possible. Landscaping should be provided between the pedestrian circulation system and automobile areas to provide protection, security and accessibility for the pedestrian while providing sufficient sight distance. Parallel parking can also be used to buffer pedestrian routes from moving vehicles.

### Pedestrian Infrastructure

An internal pedestrian circulation system should:

- Be barrier-free and designed for safety and security
- Ensure continuous sidewalks and safe crossing points
- Connect all uses within a development (buildings, parking areas, etc.)



- Clearly link public sidewalks with all internal walkways
- Clearly link the individual sites within a development to each other and to surrounding off-site uses (mixed-use and residential areas)
- Be defined with landscaping, paving, and pedestrian-scale lighting
- Meet ADA guidelines
- Provide adequate sight distance

Pedestrian circulation routes could be composed of treated surfaces such as scored or brushed concrete in order to differentiate the pedestrian system from the auto system. Where pedestrian routes cross an auto circulation route, striping should be provided.

To provide greater opportunity for pedestrian connectivity and to prevent autos from having to use the public street system to travel between adjacent developments, parking and pedestrian circulation should be designed to accommodate connections between developments.

Pedestrian circulation plans should be required with each large lot development. These plans must emphasize connectivity through sidewalk design, traffic circulation, landscaping, and lighting.

### Bicycle Infrastructure

Internal circulation for bicyclists is as important a consideration as for cars and pedestrians. Bicyclists should have a clearly delineated travel path through any development, as well as clear travel paths that link individual sites within the development and provide safe travel. In smaller developments or constrained situations, this can be accomplished through directional signage, lane markings, and signage that clearly show a shared roadway system (such as a shared lane marking), and signage and markings indicating slow speeds (10 MPH) required while in the development.

In larger developments, bicycle lanes should be striped to both indicate the travel route to bicyclists and to constantly inform motorists to expect bicyclists within the development. The bicycle lanes should be supplemented with appropriate directional signage for bicyclists. Signage and markings indicating slow speeds (10 MPH) are also recommended. Bicycle circulation plans should be required with each large lot development.

### Bicycle Parking

Bicycle parking can be broadly defined as either short-term or long-term parking:



Bolt-on ring rack



Sleeve ring rack



- Short-term parking: Bicycle parking meant to accommodate visitors, customers, messengers and others expected to depart within two hours; requires approved standard rack, appropriate location and placement, and weather protection.
- Long-term parking: Bicycle parking meant to accommodate employees, students, residents, commuters, and others expected to park more than two hours. This parking is to be provided in a secure, weather-protected manner and location.

### Short-Term Bicycle Parking

Short-term bicycle parking facilities are intended to provide short-term bicycle parking, and include racks which permit the locking of the bicycle frame and one wheel to the rack and support the bicycle in a stable position without damage to wheels, frame or components. Short-term bicycle parking is currently provided at no charge at most locations. Such facilities should continue to be free, as they provide minimal security, but encourage cycling and promote proper bicycle parking.

Bicycle rack dimensions requirements should meet or exceed those recommended by the Oregon Bicycle and Pedestrian Plan, including the following:

- Bicycle parking spaces should be at least six feet long and 2.5 feet wide, and overhead clearance for covered spaces should be at least seven feet.
- A 5-foot aisle for bicycle maneuvering should be provided and maintained beside or between each row of bicycle parking.
- Bicycle racks or lockers should be securely anchored to the surface or structure.

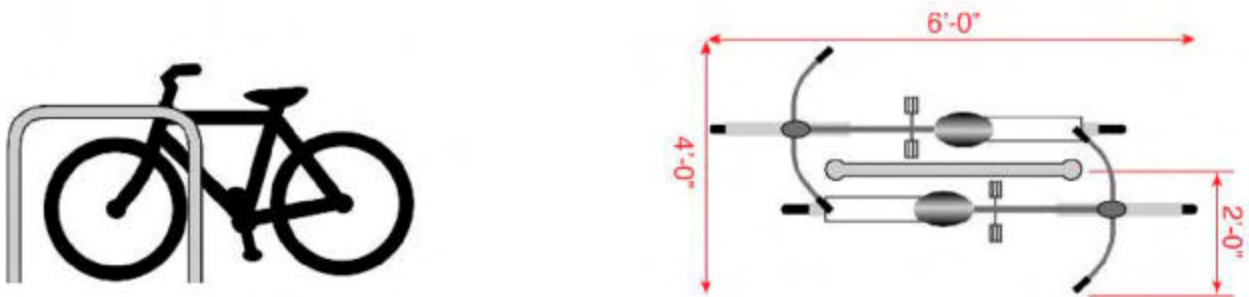
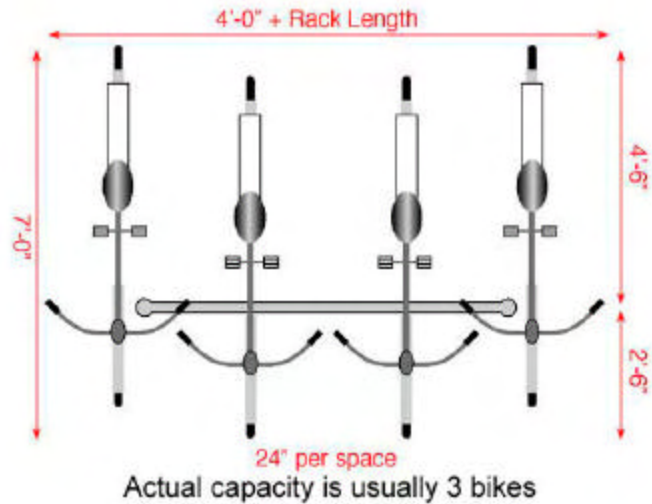

Figure 5-14. Inverted “U” Rack

### Ribbon, Spiral, or Freestanding Racks (with access from only one side)



**Figure 5-15. Ribbon, Spiral, and Freestanding Racks**

Where racks are not possible on sidewalks (because of narrow sidewalk width, sidewalk obstructions, or other issues), bicycle parking can be created in the street where on-street vehicle parking is allowed. Two possible options for creating parking in the street include clustered racks in a car parking space protected by bollards or curbs, and racks installed on sidewalk curb extensions where adequate sight distance can be provided. Installing bicycle parking directly in a car parking space incurs only the cost of the racks and bollards or other protective devices.

A curb extension is more expensive to install, and can be prohibitively expensive if substantial drainage and/or utility work is necessary. Costs may be less if the curb extension is installed as part of a larger street or pedestrian improvement project. While on-street bicycle parking may take space away from the automobile parking, there are ways to mitigate auto parking loss: Additional auto parking spaces can be created by consolidating driveways, moving fire hydrants, or otherwise finding places where it may be possible to admit auto parking where it is currently prohibited. Options for combining bicycle and motorcycle parking also exist.

On-street bicycle parking may be installed at intersection corners or at mid-block locations. Mid-block on-street parking may be closer to cyclists' destinations, although it could force cyclists to dismount and walk to the parking site if access from the street is difficult or dangerous. Combining a mid-block pedestrian crossing with mid-block on-street parking facilities could mitigate this situation.



**Table 5-5. Bicycle Rack Placement Guidelines**

Design Issue	Recommended Guidance
Minimum Rack Height	To increase visibility to pedestrians, racks should have a minimum height of 33 inches or be indicated or cordoned off by visible markers.
Signing	Where bicycle parking areas are not clearly visible to approaching cyclists, signs at least 12 inches square should direct them to the facility. The sign should give the name, phone number, and location of the person in charge of the facility, where applicable.
Lighting	Lighting of not less than one foot-candle illumination at ground level should be provided in all bicycle parking areas.
Frequency of Racks on Streets	In popular retail areas, two or more racks should be installed on each side of each block. This does not eliminate the inclusion of requests from the public which do not fall in these areas. Areas officially designated or used as bicycle routes may warrant the consideration of more racks.
Location and Access	Access to facilities should be convenient; where access is by sidewalk or walkway, curb ramps should be provided where appropriate and ADA compliant. Parking facilities intended for employees should be located near the employee entrance, and those for customers or visitors near the main public entrances. (Convenience should be balanced against the need for security if the employee entrance is not in a well traveled area). Bicycle parking should be clustered in lots not to exceed 16 spaces each. Large expanses of bicycle parking make it easier for thieves to operate undetected.
Locations within Buildings	Provide bike racks within 50 feet of the entrance. Where a security guard is present, provide racks behind or within view of a security guard. The location should be outside the normal flow of pedestrian traffic.
Locations near Transit Stops	To prevent bicyclists from locking bikes to bus stop poles - which can create access problems for transit users, particularly those who are disabled - racks should be placed in close proximity to transit stops where there is a demand for short-term bike parking.
Locations within a Campus-Type Setting	Racks are useful in a campus-type setting at locations where the user is likely to spend less than two hours, such as classroom buildings. Racks should be located near the entrance to each building. Where racks are clustered in a single location, they should be surrounded by a fence and watched by an attendant. The attendant can often share this duty with other duties to reduce or eliminate the cost of labor being applied to the bike parking duties; a cheaper alternative to an attendant may be to site the fenced bicycle compound in a highly visible location on the campus. For the long-term parking needs of employees and students, attendant parking and/or bike lockers are recommended.
Retrofit Program	In established locations, such as schools, employment centers, and shopping centers, the City should conduct bicycle parking audits to assess the bicycle parking availability and access, and add in additional bicycle racks where necessary.





## Long-Term Bicycle Parking

Long-term bicycle parking facilities are intended to provide secure long-term bicycle storage. Long-term facilities protect the entire bicycle, its components and accessories against theft and against inclement weather, including snow and wind-driven rain. Examples include lockers, check-in facilities, monitored parking, restricted access parking, and personal storage.

Long-term parking facilities are more expensive to provide than short-term facilities, but are also significantly more secure. Although many bicycle commuters would be willing to pay a nominal fee to guarantee the safety of their bicycle, long-term bicycle parking should be free wherever automobile parking is free. Potential locations for long-term bicycle parking include large employers and institutions where people use their bikes for commuting, and not consistently throughout the day. An advantage of lockers is that they can be configured to more easily accommodate different styles of bicycles, such as recumbent bicycles.

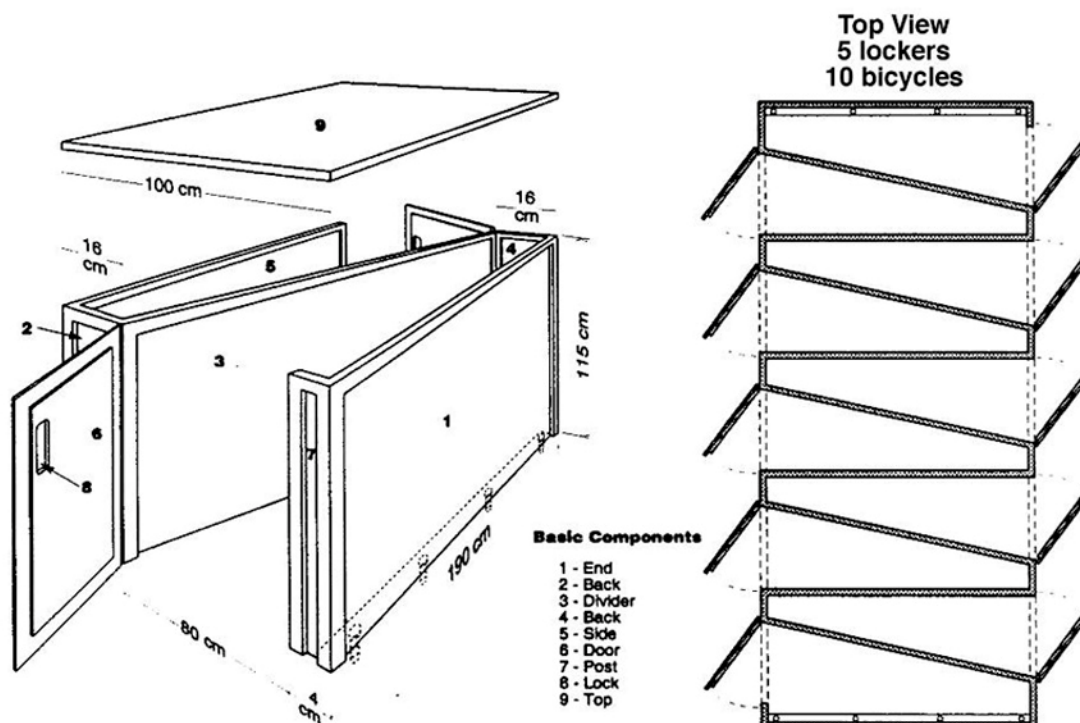
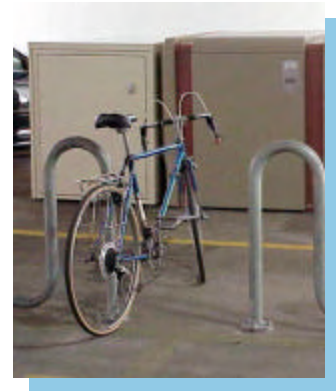

Figure 5-16. Cycle-Safe Lockers



## Transit Stops

This section provides guidance for the design a specific transit stop elements, including sidewalk approaches, landing pads, bus pullouts and bus shelters.

### Sidewalk and Path Approaches

Pedestrian connections should be designed to provide the most direct route to transit stops to avoid out-of-direction travel and minimize travel distance. Direct routes will also reduce the damage to landscaping by providing pedestrians with other preferred routes. Connections should be a continuation of the sidewalk and path system to reduce dead-end paths. At transit stops, sidewalks should be provided at a minimum to the nearest intersection or to the nearest section of existing sidewalk. It may also be necessary to wrap a sidewalk around a corner to join an existing sidewalk on a side street. If a transit route does not have complete sidewalks, it is still important to provide a suitable area for waiting pedestrians.

### Landing Pads

At permanent bus stops, the ADA requires an eight- by five-foot landing pad to accommodate disabled users. For bus stops along streets without curbs, the roadway shoulder should be at least eight feet wide to serve as the landing pad.

### Bus Pullouts

Where traffic conditions warrant a bus pullout at an intersection, a far-side location is preferred. The needs of passengers boarding or exiting the bus should not conflict with the needs of pedestrians and cyclists moving through the area. A curb extension helps pedestrian crossing movements, prevents motorists from entering the bus pullout area, and reduces conflicts with through bicyclists. Each pullout should be designed to meet roadway conditions and bus characteristics.

Where parking is allowed on streets, a curb extension can be placed within the parking lane so that passengers may board or exit the bus without stepping into the street. This also makes it easier to meet ADA requirements (the bus pulls up right next to the curb).

### Bus Shelters

A standard-size bus shelter requires a six- by 10-foot pad. The shelter should be placed at least two feet from the curb when facing away from the street and at least four feet when facing toward the street. The adjacent sidewalk must still have a five-foot clear passage. Orientation of the shelter should take into account prevailing winter winds. Sidewalks separated from the roadway with a planter strip offer a unique opportunity to provide a bus shelter out of the path of passing pedestrians.



## Maintenance Guidelines

Proper maintenance of pedestrian and bicycle facilities is a critical element of providing a safe and user-friendly system. Table 5-6 summarizes a recommended maintenance schedule for Newport's bicycle/pedestrian system. These guidelines address maintenance of the system's off-street portions. On-street segments should be maintained according to the standards of the responsible jurisdiction (e.g., City, ODOT, etc.).

**Table 5-6. Maintenance Guidelines**

Maintenance Task	Frequency
Inspections	Seasonal – at both beginning and end of summer
Signage replacement	1-3 years
Site furnishings; replace damaged components	As needed
Fencing repair	Inspect monthly for holes and damage, repair immediately
Pavement markings replacement	1-3 years
Pavement sweeping/blowing	As needed; before high use season
Pavement sealing; pothole repair	5-15 years
Lighting repair	Annually
Introduced tree and shrub plantings, trimming	1-3 years
Shrub/tree irrigation for introduced planting areas	Weekly during summer months until plants are established
Shoulder plant trimming (weeds, trees, branches)	Twice a year; middle of growing season
Major damage response (fallen trees, washouts, flooding)	Schedule based on priorities
Culvert inspection	Before rainy season; after major storms
Maintaining culvert inlets	Inspect before onset of wet season
Waterbar maintenance (earthen trails)	Annually
Trash disposal	Weekly during high use; twice monthly during low use
Litter pick-up	Weekly during high use; twice monthly during low use
Graffiti removal	Weekly; as needed





# Newport

---

## Pedestrian & Bicycle Plan



### 6. FUNDING SOURCES

#### Federal Funding Sources

Federal funding is primarily distributed through a number of different programs established by the Federal Transportation Act. The latest act, The Safe, Accountable, Flexible, Efficient Transportation Equity Act – a Legacy for Users (SAFETEA-LU) was enacted in August 2005 as Public Law 109-59. SAFETEA-LU authorizes the Federal surface transportation programs for highways, highway safety, and transit for the 5-year period 2005-2009.

In Oregon, Federal funding is administered through State (ODOT) and regional planning agencies. Most, but not all, of these funding programs are oriented toward transportation versus recreation, with an emphasis on reducing auto trips and providing inter-modal connections. Federal funding is intended for capital improvements and safety and education programs, and projects must relate to the surface transportation system.

#### SAFETEA-LU

There are a number of programs identified within SAFETEA-LU that provide for the funding of bicycle and pedestrian projects.

#### Surface Transportation Program

The Surface Transportation Program (STP) provides states with flexible funds which may be used for a wide variety of projects on any Federal-aid Highway including the National Highway System, bridges on any public road, and transit facilities.

Bicycle and pedestrian improvements are eligible activities under the STP. This covers a wide variety of projects such as on-street facilities, off-road trails, sidewalks, crosswalks, bicycle and pedestrian signals, parking, and other ancillary facilities. SAFETEA-LU also specifically clarifies that the modification of sidewalks to comply with the requirements of the Americans with Disabilities Act is an eligible activity.

As an exception to the general rule described above, STP-funded bicycle and pedestrian facilities may be located on local and collector roads which are not part of the Federal-aid Highway System. In addition, bicycle-related non-construction projects, such as maps, coordinator positions, and encouragement programs, are eligible for STP funds. ODOT estimates that they will receive an average of \$84 million annually for this program through the lifetime of SAFETEA-LU.

### **Highway Safety Improvement Program**

This program funds projects designed to achieve significant reductions in traffic fatalities and serious injuries on all public roads, bikeways and walkways. This program includes the Railway-Highway Crossings Program and the High Risk Rural Roads Program. ODOT estimates that they will receive an average of \$14 million annually for this program through the lifetime of SAFETEA-LU. This program replaces the Hazard Elimination Program from TEA-21.

### **Transportation Enhancements**

Administered by ODOT, this program is funded by a set-aside of STP funds. Projects must serve a transportation need. These funds can be used to build a variety of pedestrian, bicycle, streetscape and other improvements that enhance the cultural, aesthetic, or environmental value of transportation systems. The statewide grant process is competitive.

### **Congestion Mitigation/Air Quality Program**

The Congestion Mitigation/Air Quality Improvement Program (CMAQ) provides funding for projects and programs in air quality non-attainment and maintenance areas for ozone, carbon monoxide, and particulate matter which reduce transportation related emissions.

These federal funds can be used to build bicycle and pedestrian facilities that reduce travel by automobile. Recreational facilities generally are not funded. ODOT estimates that they will receive an average of \$14 million annually for this program through the lifetime of SAFETEA-LU.

### **Recreational Trails Program**

The Recreational Trails Program of the Federal Transportation Bill provides funds to states to develop and maintain recreational trails and trail-related facilities for both non-motorized and motorized recreational trail uses. Examples of trail uses include hiking, bicycling, in-line skating, equestrian use, and other non-motorized and motorized uses. These funds are available for both paved and unpaved trails, but may not be used to improve roads for general passenger vehicle use or to provide shoulders or sidewalks along roads.

Recreational Trails Program funds may be used for:

- Maintenance and restoration of existing trails
- Purchase and lease of trail construction and maintenance equipment
- Construction of new trails, including unpaved trails
- Acquisition or easements of property for trails
- State administrative costs related to this program (limited to seven percent of a State's funds)
- Operation of educational programs to promote safety and environmental protection related to trails (limited to five percent of a State's funds)

### **Safe Routes to School (SR2S)**

Under the SR2S Program, Federal funds are administered by ODOT. Under the Oregon Safe Routes to School Program, approximately \$3.7 million will be available for grants between 2006 and 2010. The grants can be used to identify and reduce barriers and hazards to children walking or bicycling to school. ODOT estimates that they will receive an average of \$1.37 million annually for this program through the lifetime of SAFETEA-LU.



### **New Freedom Initiative**

SAFETEA-LU creates a new formula grant program that provides capital and operating costs to provide transportation services and facility improvements that exceed those required by the Americans with Disabilities Act.

### **Community Development Block Grants**

The Community Development Block Grants program provides money for streetscape revitalization, which may be largely comprised of pedestrian improvements. Federal Community Development Block Grant grantees may “use Community Development Block Grants funds for activities that include (but are not limited to): acquiring real property; reconstructing or rehabilitating housing and other property; building public facilities and improvements, such as streets, sidewalks, community and senior citizen centers and recreational facilities; paying for planning and administrative expenses, such as costs related to developing a consolidated plan and managing Community Development Block Grants funds; provide public services for youths, seniors, or the disabled; and initiatives such as neighborhood watch programs.”

### **Rivers, Trails and Conservation Assistance Program**

The Rivers, Trails and Conservation Assistance Program (RTCA) is a National Parks Service program which provides technical assistance via direct staff involvement, to establish and restore greenways, rivers, trails, watersheds and open space. The RTCA program provides only for planning assistance—there are no implementation monies available. Projects are prioritized for assistance based on criteria that include conserving significant community resources, fostering cooperation between agencies, serving a large number of users, encouraging public involvement in planning and implementation, and focusing on lasting accomplishments.

### **Land and Water Conservation Fund**

The Land and Water Conservation Fund (LWCF) is a Federally-funded program that provides grants for planning and acquiring outdoor recreation areas and facilities, including trails. Funds can be used for right-of-way acquisition and construction. These funds are administered by the Oregon Parks and Recreation Department.

### **Transportation, Community and System Preservation Program**

The Transportation, Community and System Preservation Program provides federal funding for transit-oriented development, traffic calming and other projects that improve the efficiency of the transportation system, reduce the impact on the environment, and provide efficient access to jobs, services and trade centers. The program is intended to provide communities with the resources to explore the integration of their transportation system with community preservation and environmental activities. The Transportation, Community and System Preservation Program funds require a 20 percent match.

## **State Funding Sources**

### **Statewide Transportation Improvement Program**

The Statewide Transportation Improvement Program (STIP) is ODOT’s short-term capital improvement program, providing project funding and scheduling information for the department and Oregon’s metropolitan planning organizations. It is a four-year program developed through the coordinated efforts of ODOT, federal and local governments, Area Commissions on Transportation, tribal governments and the public.



In developing this funding program, ODOT must verify that the identified projects comply with the Oregon Transportation Plan (OTP), ODOT Modal Plans, Corridor Plans, local comprehensive plans, and SAFETEA-LU planning requirements. The STIP must fulfill Federal planning requirements for a staged, multi-year, statewide, intermodal program of transportation projects. Specific transportation projects are prioritized based on Federal planning requirements and the different State plans. ODOT consults with local jurisdictions before highway-related projects are added to the STIP.

### **Oregon Revised Statute 366.514**

Often referred to as the “Oregon Bike Bill,” this law applies equally to bicycle and pedestrian facilities. The statute’s intent is to ensure that future roads be built to accommodate bicycle and pedestrian travel. The statute requires the provision of bicycle and pedestrian facilities on all Major Arterial and Collector roadway construction, reconstruction or relocation projects where conditions permit. The statute also requires that in any fiscal year, at least one percent of highway funds allocated to a jurisdiction must be used for bicycle/pedestrian projects.

### **Oregon Transportation Infrastructure Bank**

The Oregon Transportation Infrastructure Bank is a statewide revolving loan fund designed to promote innovative transportation funding solutions. Oregon’s program was started in 1996 as part of a 10-state Federal pilot program. Additional legislation passed in 1997 by the Oregon Legislature establishes the program in state law and includes expanded authority. Eligible borrowers include cities, counties, transit districts, other special districts, port authorities, tribal governments, state agencies, and private for-profit and non-profit entities. Eligible projects include:

- Highway projects, such as roads, signals, intersection improvements and bridges
- Transit capital projects, such as buses, equipment, and maintenance or passenger facilities
- Bikeway or pedestrian access projects on highway right-of-way

Eligible project costs include preliminary engineering, environmental studies, right-of-way acquisition, construction (including project management and engineering), inspections, financing costs, and contingencies.

### **Measure 66 Funds – Oregon State Lottery**

Ballot Measure 66 amends the Oregon Constitution to allow money from the State Lottery to be used for restoring and protecting Oregon’s parks, beaches, watersheds and critical fish and wildlife habitat. Funds are coordinated by Oregon State Parks, and may be used for trail-related right-of-way acquisition and construction.

### **Special Transportation Fund**

The State’s Special Transportation Fund Program provides financial support to designated counties, transit districts and Indian tribal governments for special transportation services benefiting seniors and people with disabilities. The majority of the STF money (75 percent) is allocated on a population-based formula. The remaining funds are distributed by the Public Transportation Discretionary Grant Program.





## Bicycle and Pedestrian Program Grants

The Pedestrian and Bicycle Grant Program is a competitive grant program that provides approximately \$5 million every two years to Oregon cities, counties and ODOT regional and district offices for design and construction of pedestrian and bicycle facilities. Proposed facilities must be within public rights-of-way. Grants are awarded by the Oregon Bicycle and Pedestrian Advisory Committee.

## Bicyclist Safety Mini-Grant Program

The Community Cycling Center Bicyclist Mini-Grant Program provides funding to public agencies and non-profit 501(c)(3) organizations to promote the safety of bicyclists in Oregon. Funding is available statewide through a grant to the Community Cycling Center from ODOT's Transportation Safety Division. Funding is available for projects targeting youth and/or adults, with a focus on projects that incorporate a strong educational element, especially in communities that do not currently have access to bike safety education resources. For communities that currently do have access to these resources, innovative and creative project proposals are highly encouraged. Applicants may apply for grants between \$800 and \$5,000.

## Pedestrian Safety Mini-Grant Program

Administered by Oregon's Bicycle Transportation Alliance and the Willamette Pedestrian Coalition, the Pedestrian Safety Mini-Grant Program is funded through ODOT's Traffic Safety Division. The program provides funds to police departments around the state to stage crosswalk enforcement actions against motorists who fail to yield to pedestrians. In these operations, a decoy police officer attempts to cross a street at an intersection or marked crosswalk (crosswalk laws apply to unmarked crosswalks as well). If passing motorists fail to stop and yield for the pedestrian, they are issued either a warning or a citation. The operations include a media outreach component, with the purpose of raising awareness around motorists' responsibility toward pedestrians. Grant funds may also be used to offer diversion classes that violators can take in lieu of paying tickets. Applicants may apply for grants up to \$5,000.

## Local Funding Sources

### Local Bond Measures

Local bond measures, or levies, are usually initiated by voter-approved general obligation bonds for specific projects. Bond measures are typically limited by time based on the debt load of the local government or the project under focus. Funding from bond measures can be used for right-of-way acquisition, engineering, design and construction of pedestrian and bicycle facilities.

### Tax Increment Financing/Urban Renewal Funds

Tax Increment Financing (TIF) is a tool to use future gains in taxes to finance the current improvements that will create those gains. When a public project (e.g., sidewalk improvements) is constructed, surrounding property values generally increase and encourage surrounding development or redevelopment. The increased tax revenues are then dedicated to finance the debt created by the original public improvement project. Tax Increment Financing typically occurs within designated Urban Renewal Areas (URA) that meet certain economic criteria and approved by a local governing body. To be eligible for this financing, a project (or a portion of it) must be located within the URA.



## **System Development Charges/Developer Impact Fees**

System Development Charges (SDCs), also known as Developer Impact Fees, represent another potential local funding source. SDCs are typically tied to trip generation rates and traffic impacts produced by a proposed project. A developer may reduce the number of trips (and hence impacts and cost) by paying for on- or off-site pedestrian improvements that will encourage residents to walk or use transit rather than drive. In-lieu parking fees may be used to help construct new or improved pedestrian facilities. Establishing a clear nexus or connection between the impact fee and the project's impacts is critical in avoiding a potential lawsuit.

## **Street User Fees**

The revenue generated by the street user fee is used for operations and maintenance of the street system, and priorities are established by the Public Works Department. Revenue from this fund should be used to maintain on-street bicycle and pedestrian facilities, including routine sweeping of bicycle lanes and other designated bicycle routes.

## **Local Improvement Districts (LIDs)**

Local Improvement Districts (LIDs) are most often used by cities to construct localized projects such as streets, sidewalks or bikeways. Through the LID process, the costs of local improvements are generally spread out among a group of property owners within a specified area. The cost can be allocated based on property frontage or other methods such as traffic trip generation.

## **Business Improvement Districts**

Pedestrian improvements can often be included as part of larger efforts aimed at business improvement and retail district beautification. Business Improvement Districts collect levies on businesses in order to fund area-wide improvements that benefit businesses and improve access for customers. These districts may include provisions for pedestrian and bicycle improvements, such as wider sidewalks, landscaping, and ADA compliance.

## **Other Local Sources**

Residents and other community members are excellent resources for garnering support and enthusiasm for a bicycle and pedestrian facility, and the City should work with volunteers to substantially reduce implementation and maintenance costs. Local schools, community groups, or a group of dedicated neighbors may use the project as a project for the year, possibly working with a local designer or engineer. Work parties can be formed to help clear the right-of-way for a new path or maintain existing facilities where needed. A local construction company could donate or discount services. Other opportunities for implementation will appear over time, such as grants and private funds. The City should look to its residents for additional funding ideas to expedite completion of the bicycle and pedestrian system.

## **Other Funding Sources**

### **American Greenways Program**

Administered by The Conservation Fund, the American Greenways Program provides funding for the planning and design of greenways. Applications for funds can be made by local, regional or statewide non-profit organizations and public agencies.



The maximum award is \$2,500, but most awards range from \$500 to \$1,500. American Greenways Program monies may be used to fund unpaved trail development.

